



US00D818711S

(12) **United States Design Patent** (10) **Patent No.:** **US D818,711 S**  
**Kwon** (45) **Date of Patent:** **\*\* May 29, 2018**

(54) **LUGGAGE WITH MARBLE PATTERNED DESIGN**

(57) **CLAIM**

The ornamental design for a luggage with marble patterned design, as shown and described.

(71) Applicant: **California Pak International, Inc.**,  
Compton, CA (US)

(72) Inventor: **Jennifer Kwon**, Compton, CA (US)

**DESCRIPTION**

(73) Assignee: **CALIFORNIA PAK INTERNATIONAL, INC.**, Compton,  
CA (US)

(\*\*) Term: **15 Years**

FIG. 1 is a top perspective view of a first embodiment of a luggage with marble patterned design, showing my new design.

FIG. 2 is a bottom perspective view thereof.

FIG. 3 is a rear elevational view thereof.

FIG. 4 is a front elevational view thereof.

FIG. 5 is a right side elevational view thereof.

FIG. 6 is a left side elevational view thereof.

FIG. 7 is a top plan view thereof.

FIG. 8 is a bottom plan view thereof.

FIG. 9 is a top perspective view of a second embodiment of the luggage with marble patterned design, showing my new design.

FIG. 10 is a bottom perspective view thereof.

FIG. 11 is a rear elevational view thereof.

FIG. 12 is a front elevational view thereof.

FIG. 13 is a right side elevational view thereof.

FIG. 14 is a left side elevational view thereof.

FIG. 15 is a top plan view thereof.

FIG. 16 is a bottom plan view thereof.

FIG. 17 is a top perspective view of a third embodiment of the luggage with marble patterned design, showing my new design.

FIG. 18 is a bottom perspective view thereof.

FIG. 19 is a rear elevational view thereof.

FIG. 20 is a front elevational view thereof.

FIG. 21 is a right side elevational view thereof.

FIG. 22 is a left side elevational view thereof.

FIG. 23 is a top plan view thereof; and,

FIG. 24 is a bottom plan view thereof.

The broken lines showing the handles, feet, and wheels are for the purpose of illustrating environmental structure and unclaimed subject matter and form no part of the claimed design.

(21) Appl. No.: **29/577,087**

(22) Filed: **Sep. 9, 2016**

(51) **LOC (11) Cl.** ..... **03-01**

(52) **U.S. Cl.**  
USPC ..... **D3/279; D3/321**

(58) **Field of Classification Search**  
USPC ..... **D3/272, 273, 276, 279, 281, 282, 285,**  
**D3/287, 289, 321, 902; D5/44**

(Continued)

(56) **References Cited**

**U.S. PATENT DOCUMENTS**

D280,680 S \* 9/1985 Bomes ..... D3/279

D375,199 S \* 11/1996 Stokes ..... D3/279

(Continued)

**OTHER PUBLICATIONS**

Amazon, "Heys America Bianco 3pc Hardside Spinner Luggage Set (White Marble)", First on sale on Amazon Oct. 11, 2016, Accessed Sep. 12, 2017. (<https://www.amazon.com/Heys-America-Hardside-Spinner-Luggage/dp/B01M7O1YZ5>).\*

*Primary Examiner* — Jennifer Rivard

*Assistant Examiner* — April Rivas

(74) *Attorney, Agent, or Firm* — Anooj Patel; Kevin Schraven; Hankin Patent Law, APC

**1 Claim, 24 Drawing Sheets**

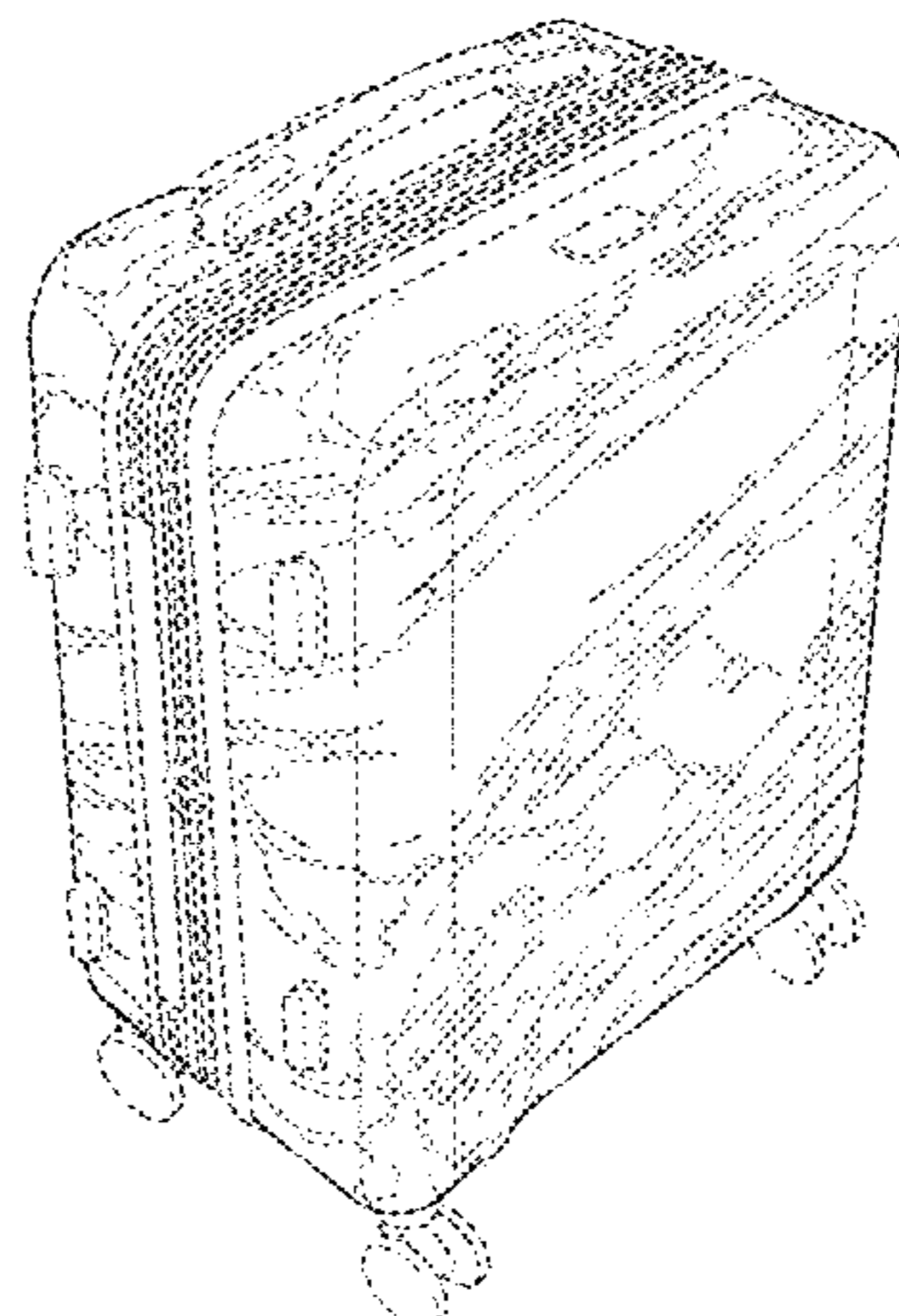

(58) **Field of Classification Search**

CPC ..... A45C 3/00; A45C 3/004; A45C 2003/008;  
A45C 5/00; A45C 5/03; A45C 2005/032;  
A45C 2005/037; A45C 5/04

See application file for complete search history.

(56) **References Cited**

U.S. PATENT DOCUMENTS

D435,967	S	*	1/2001	Tiramani	.....	D3/273
D666,414	S	*	9/2012	Giovannoni	.....	D3/279
D711,648	S	*	8/2014	Chen	.....	D3/279
D714,056	S	*	9/2014	Weng	.....	D3/279
D718,939	S	*	12/2014	Sheikh	.....	D3/321
D784,017	S	*	4/2017	Hsieh	.....	D3/279

\* cited by examiner

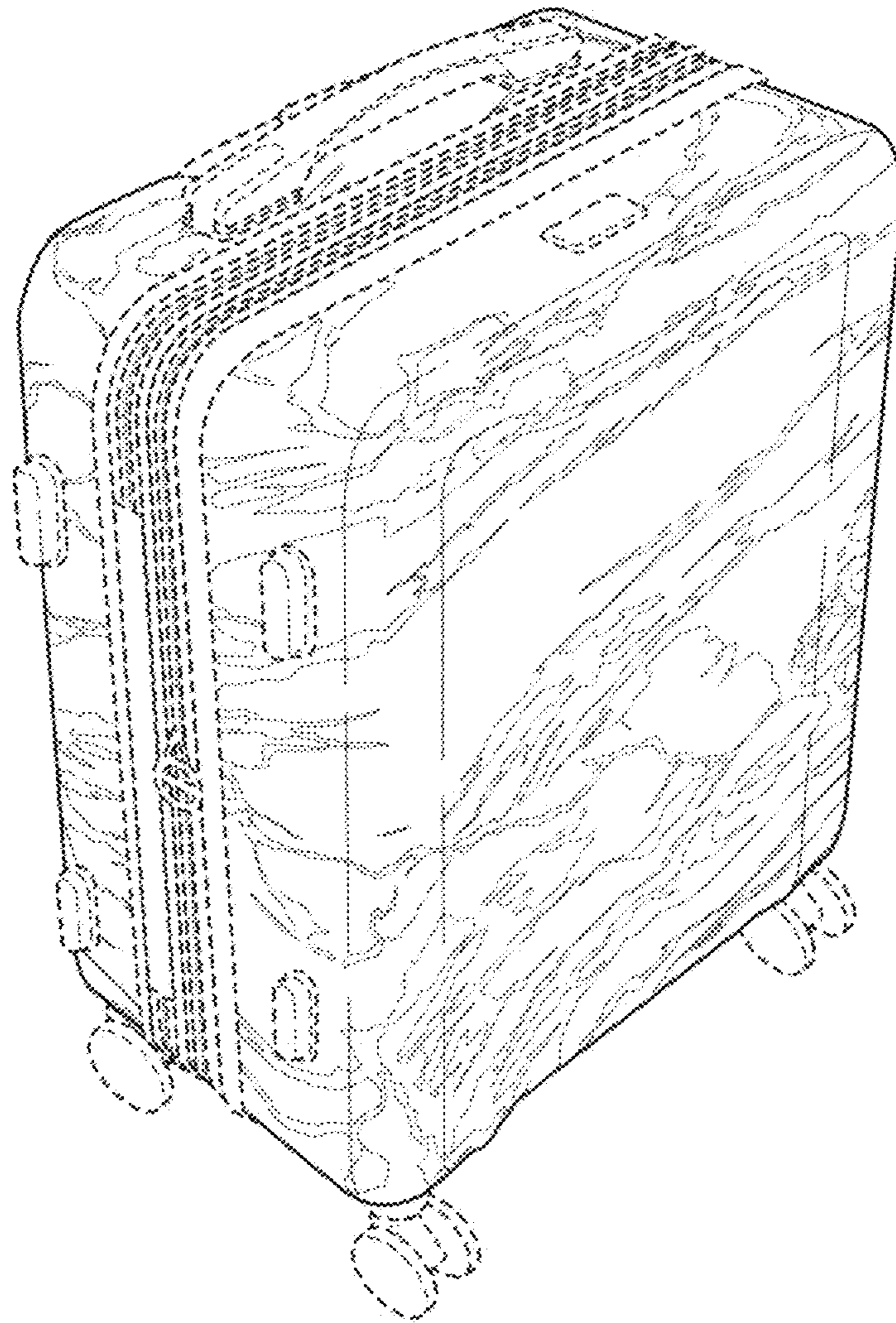

Fig. 1

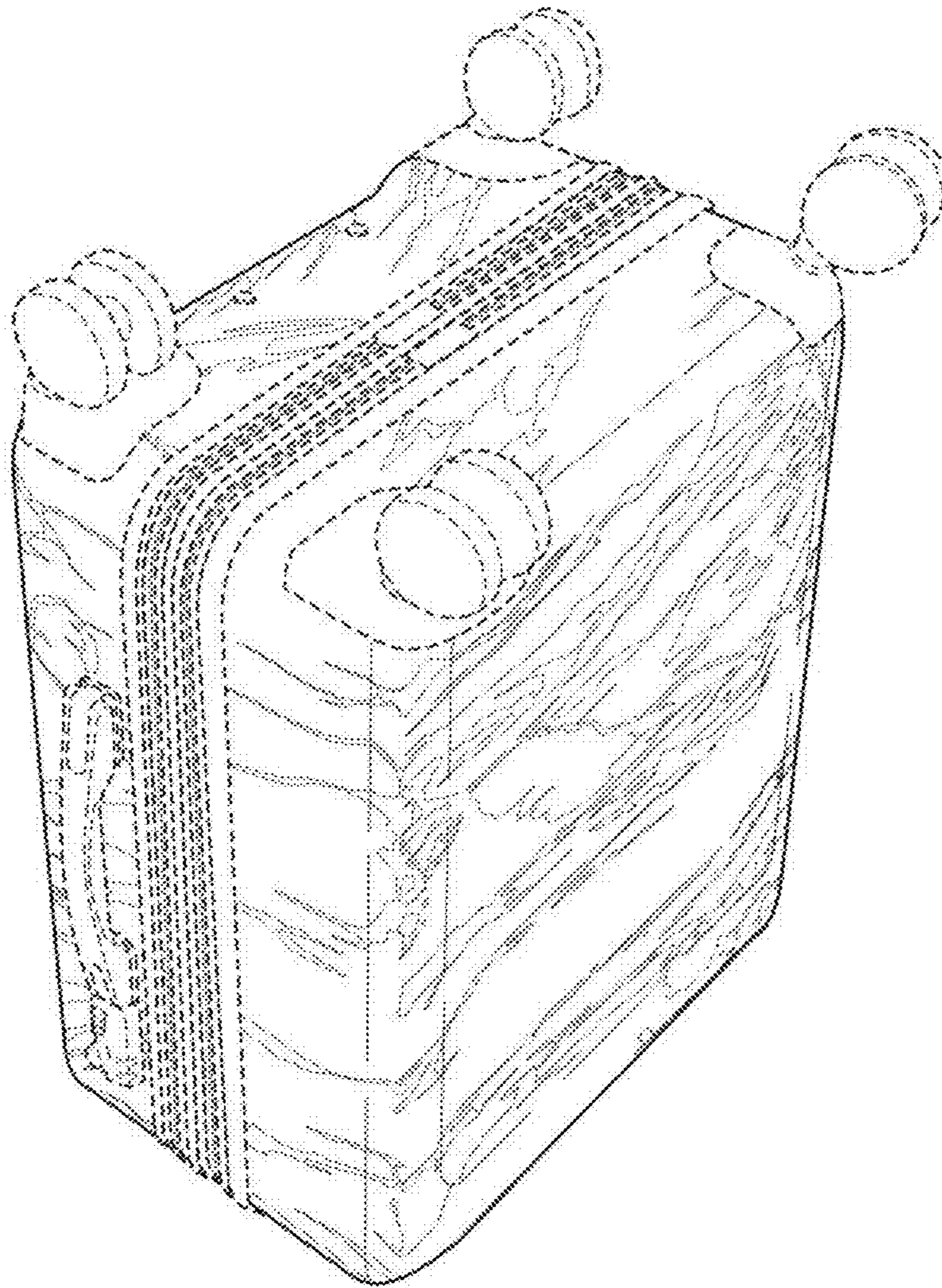

Fig.2

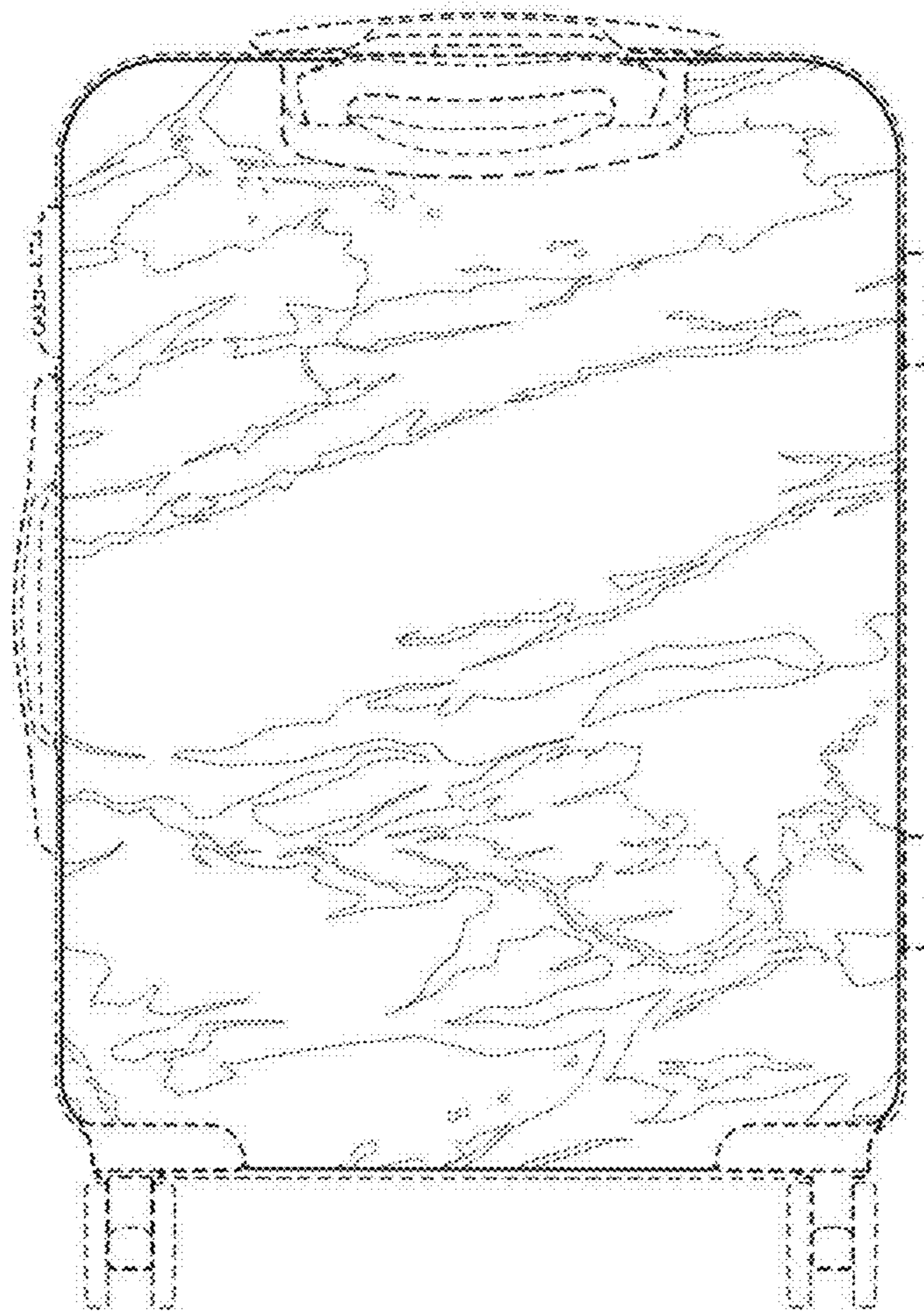

Fig. 3

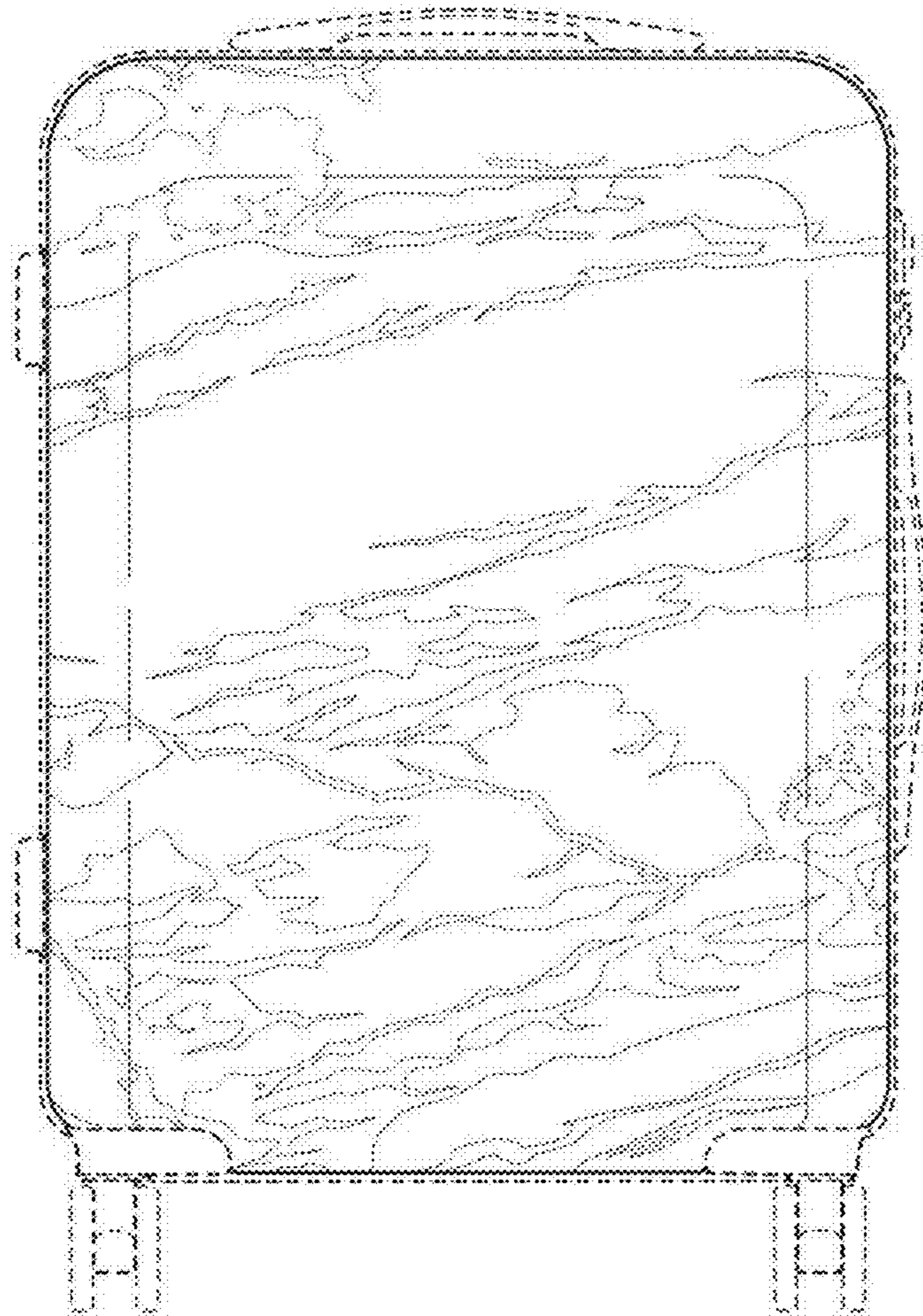

Fig.4

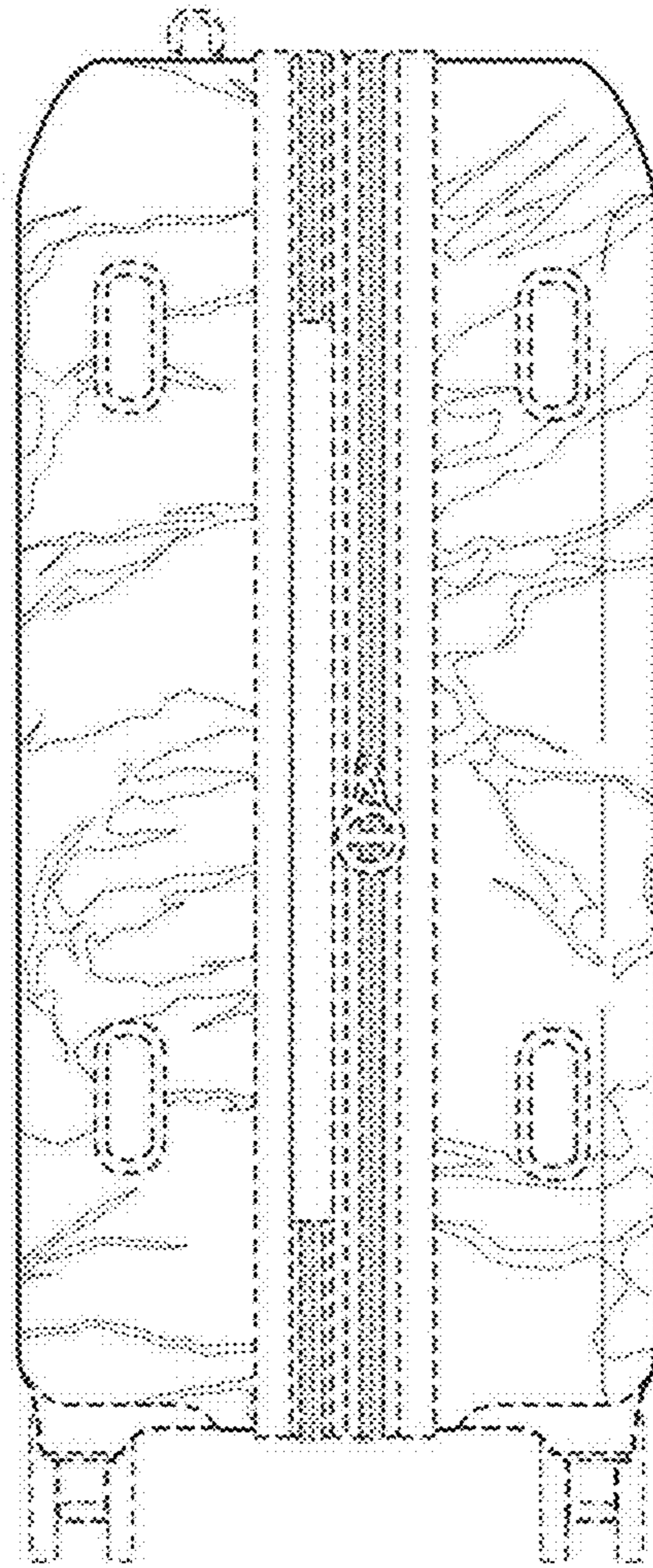

Fig. 5

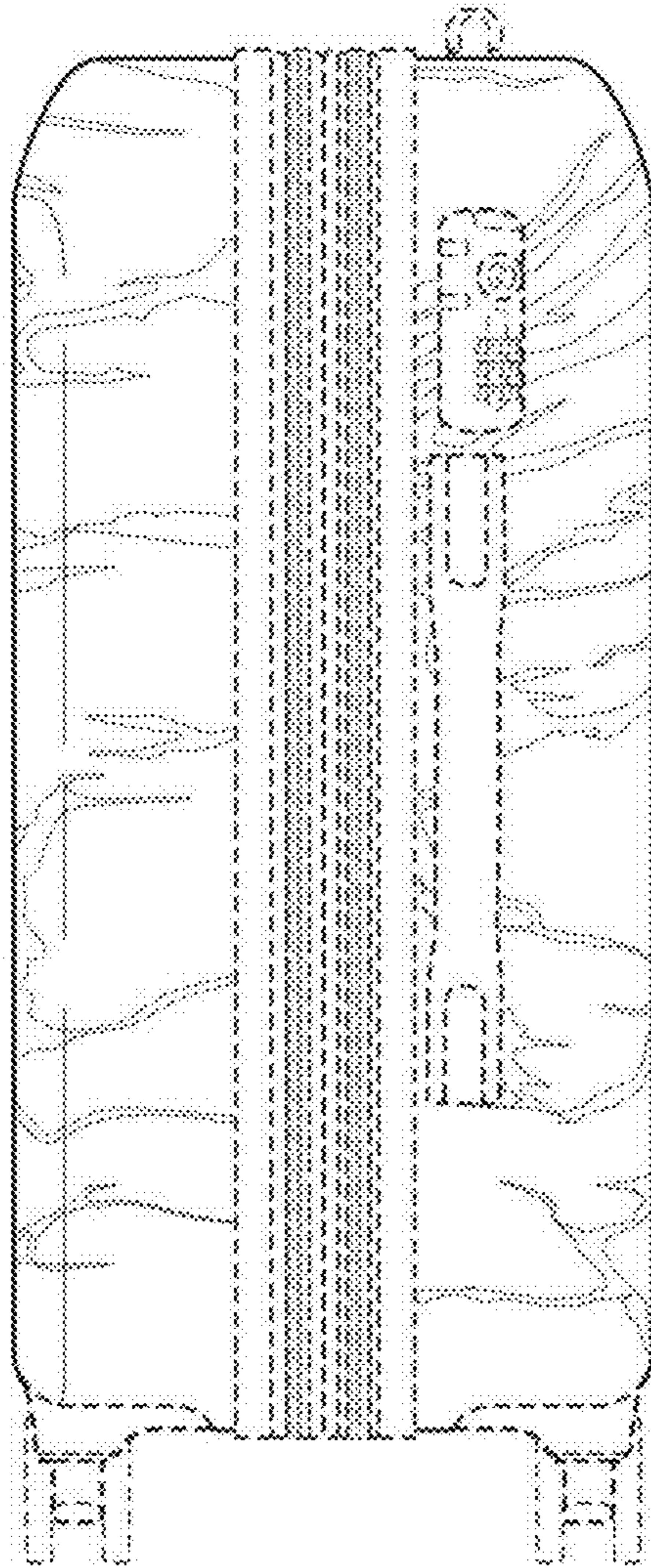

Fig. 6



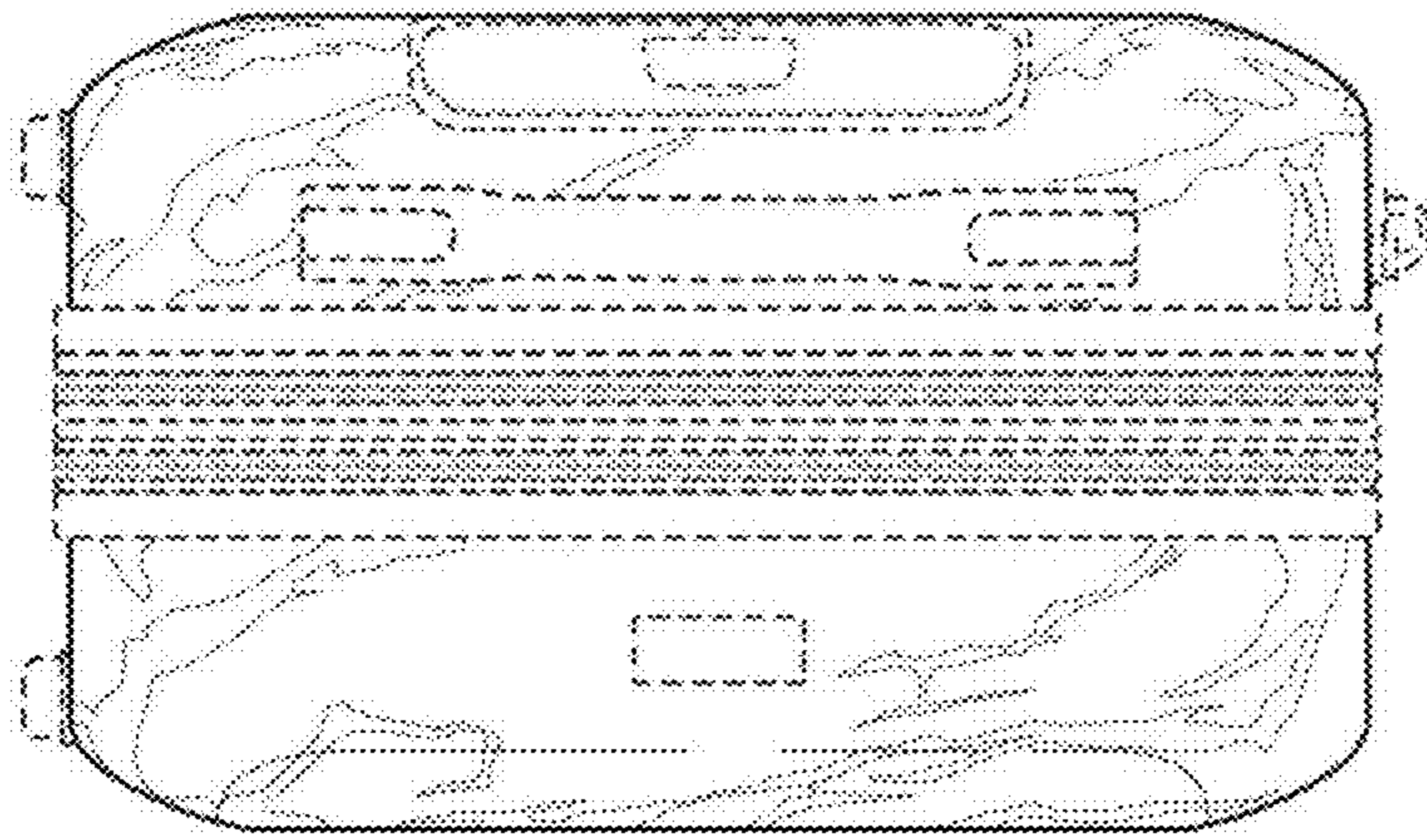

Fig. 7

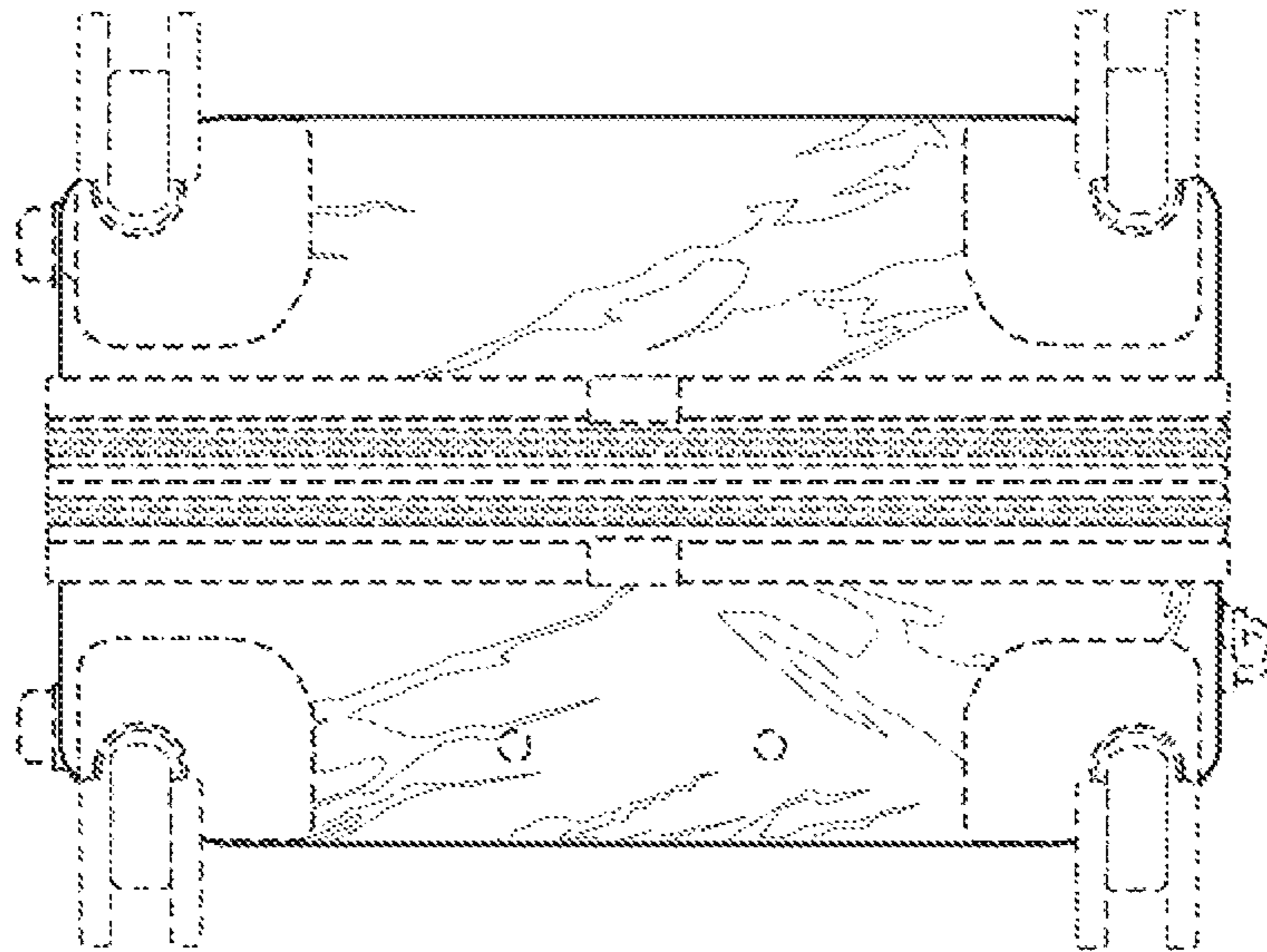

Fig. 8

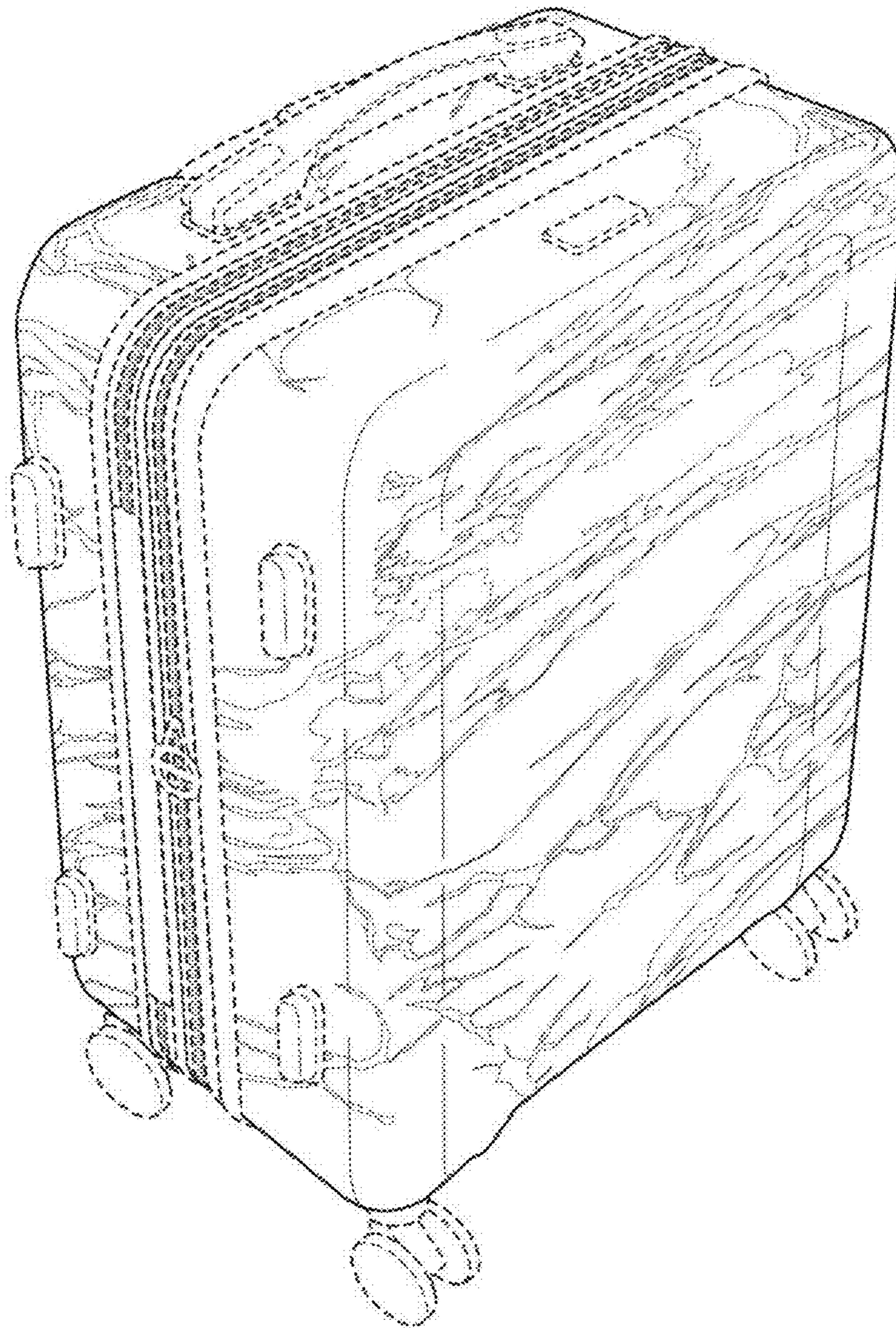

Fig. 9

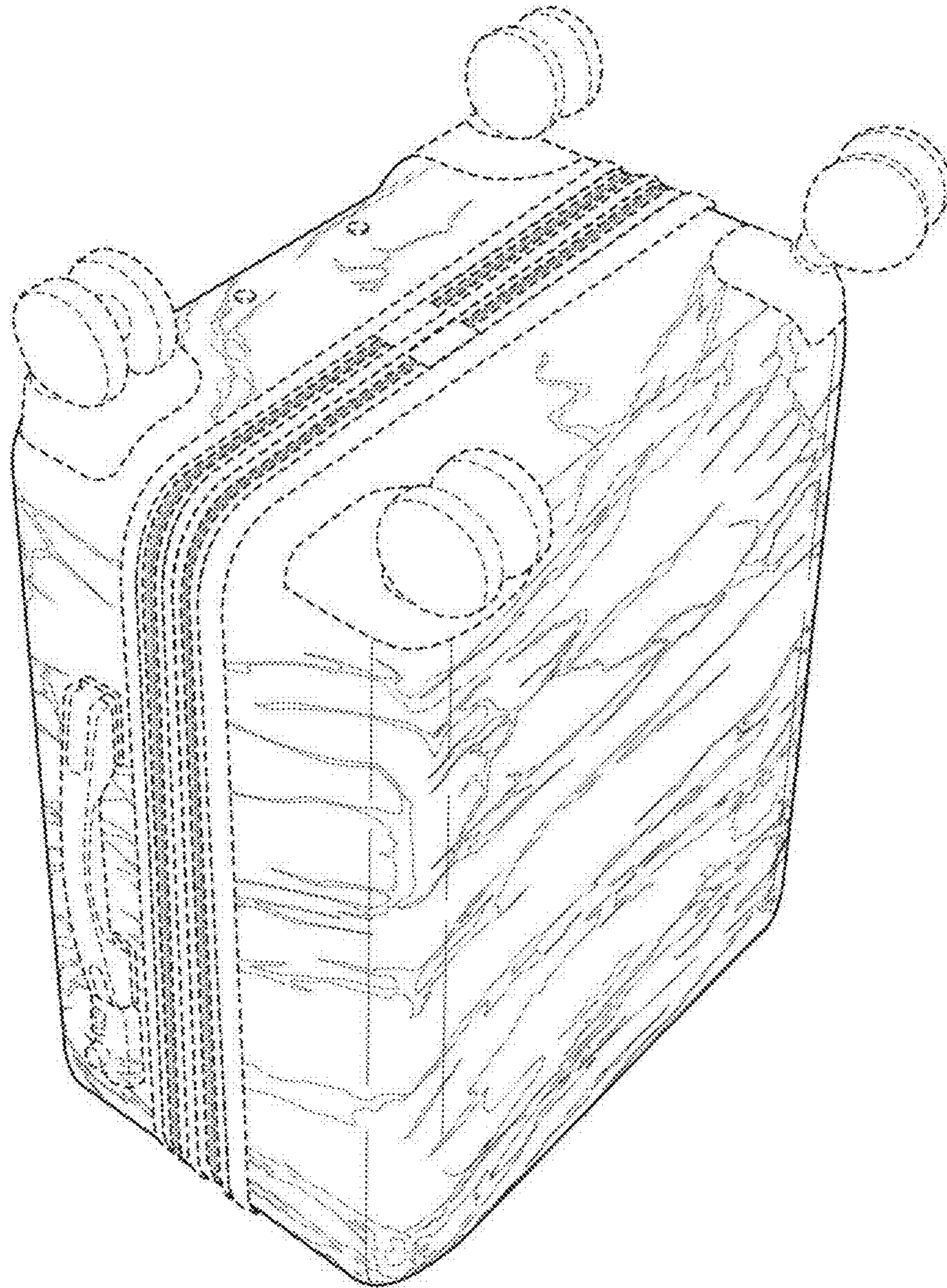

Fig. 10

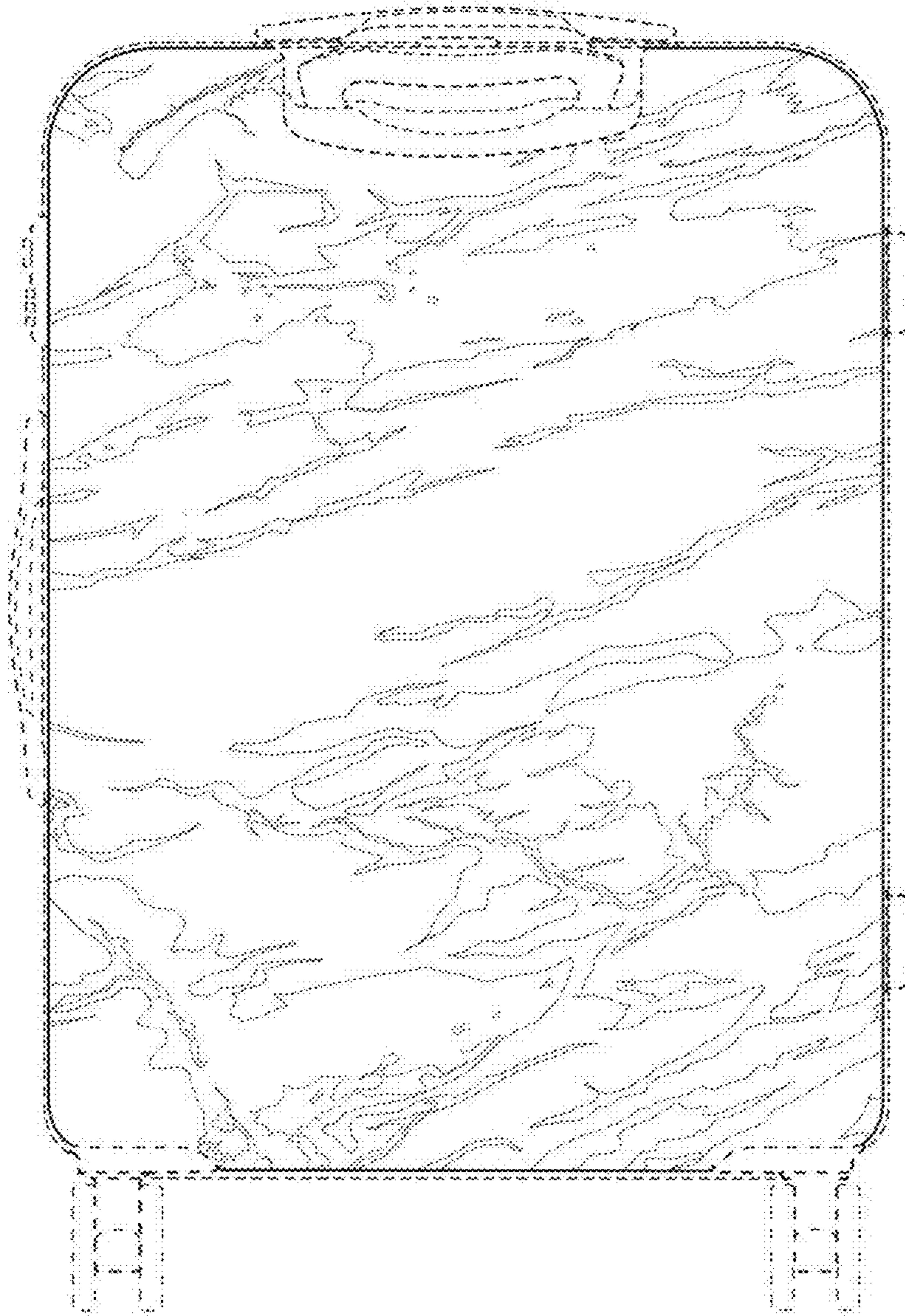

Fig. 11

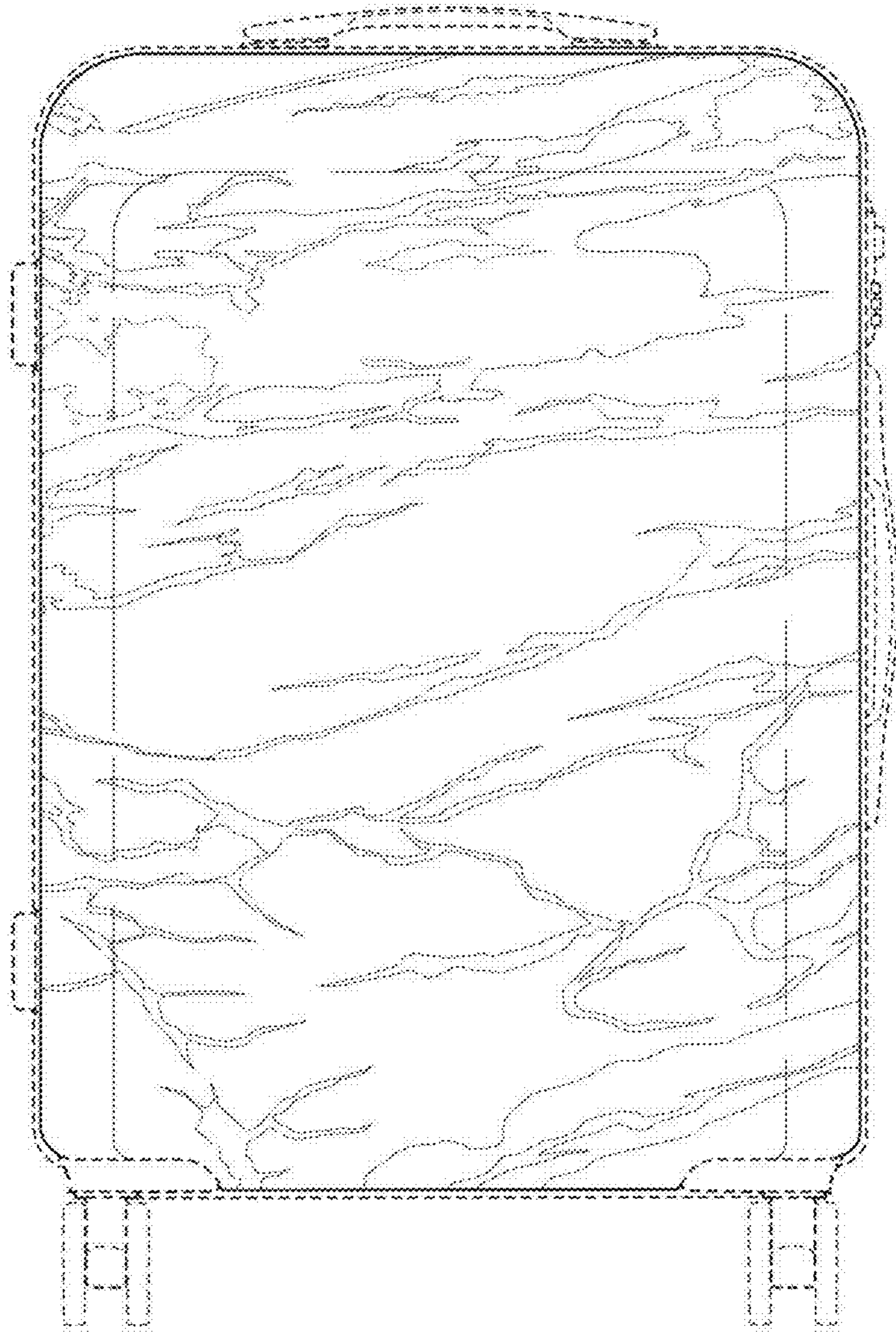

Fig. 12

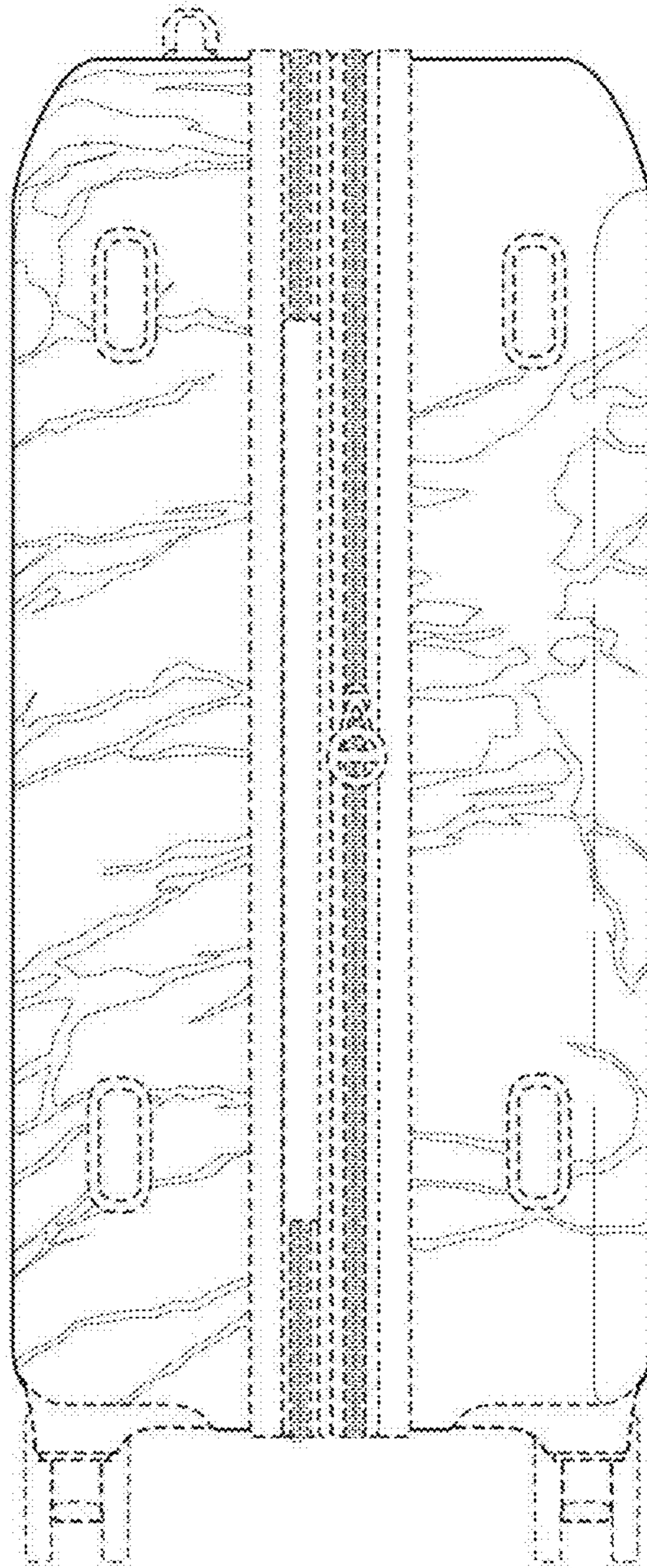

Fig. 13

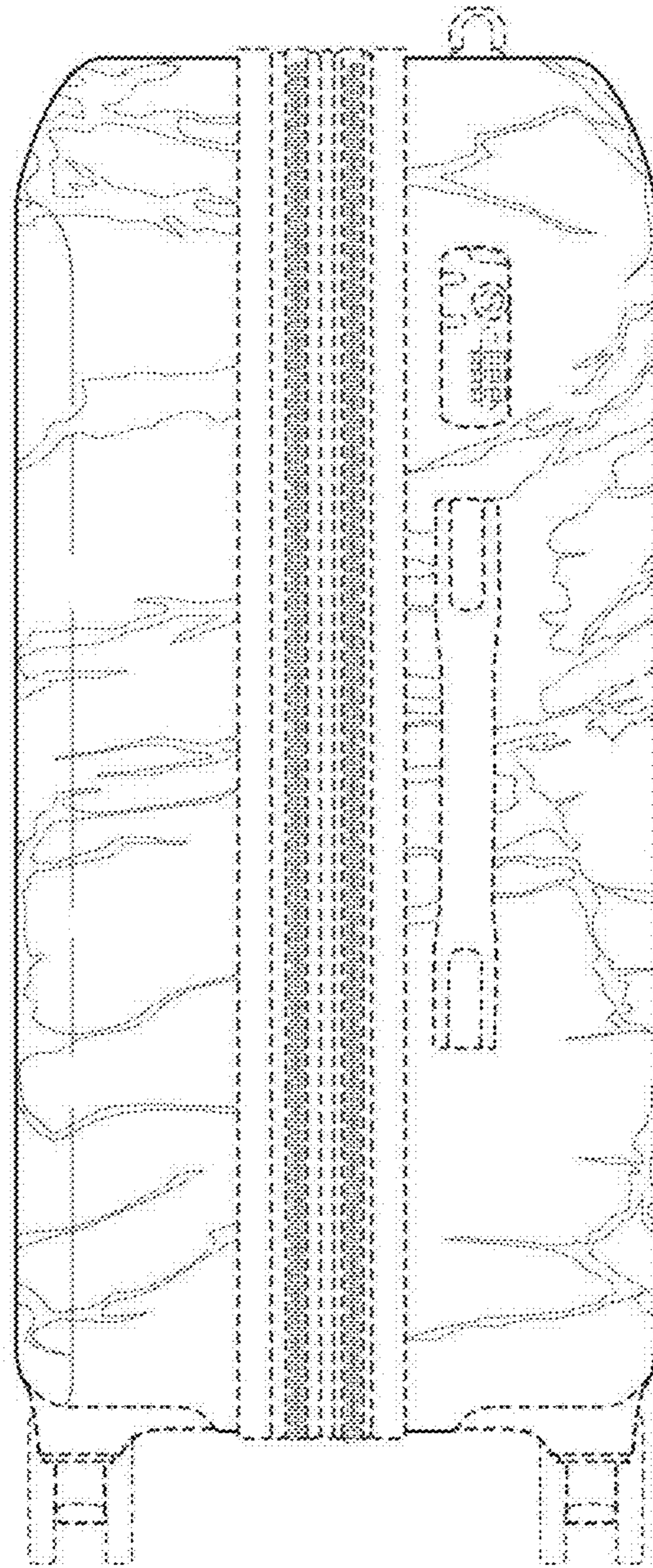

Fig. 14



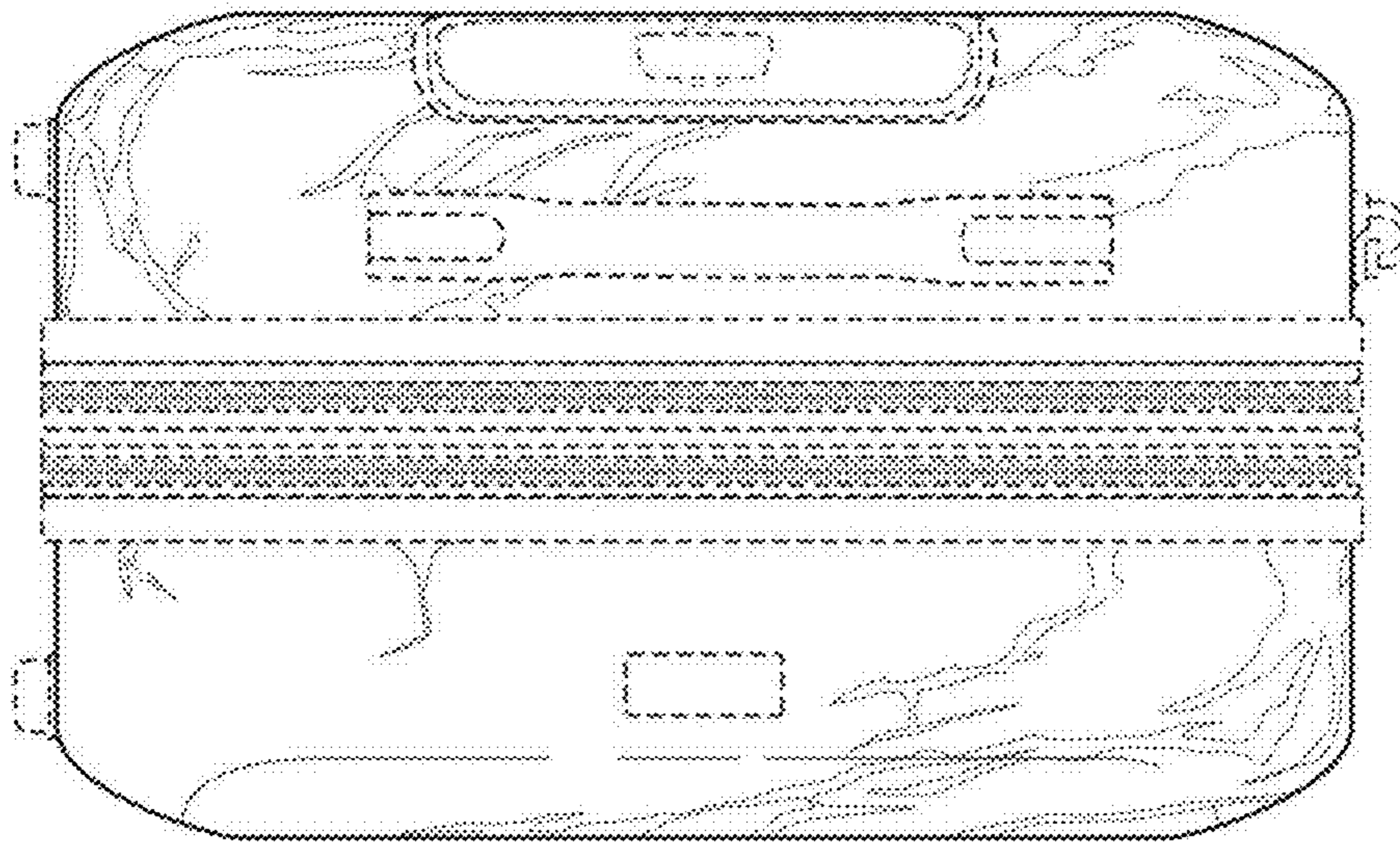

Fig. 15

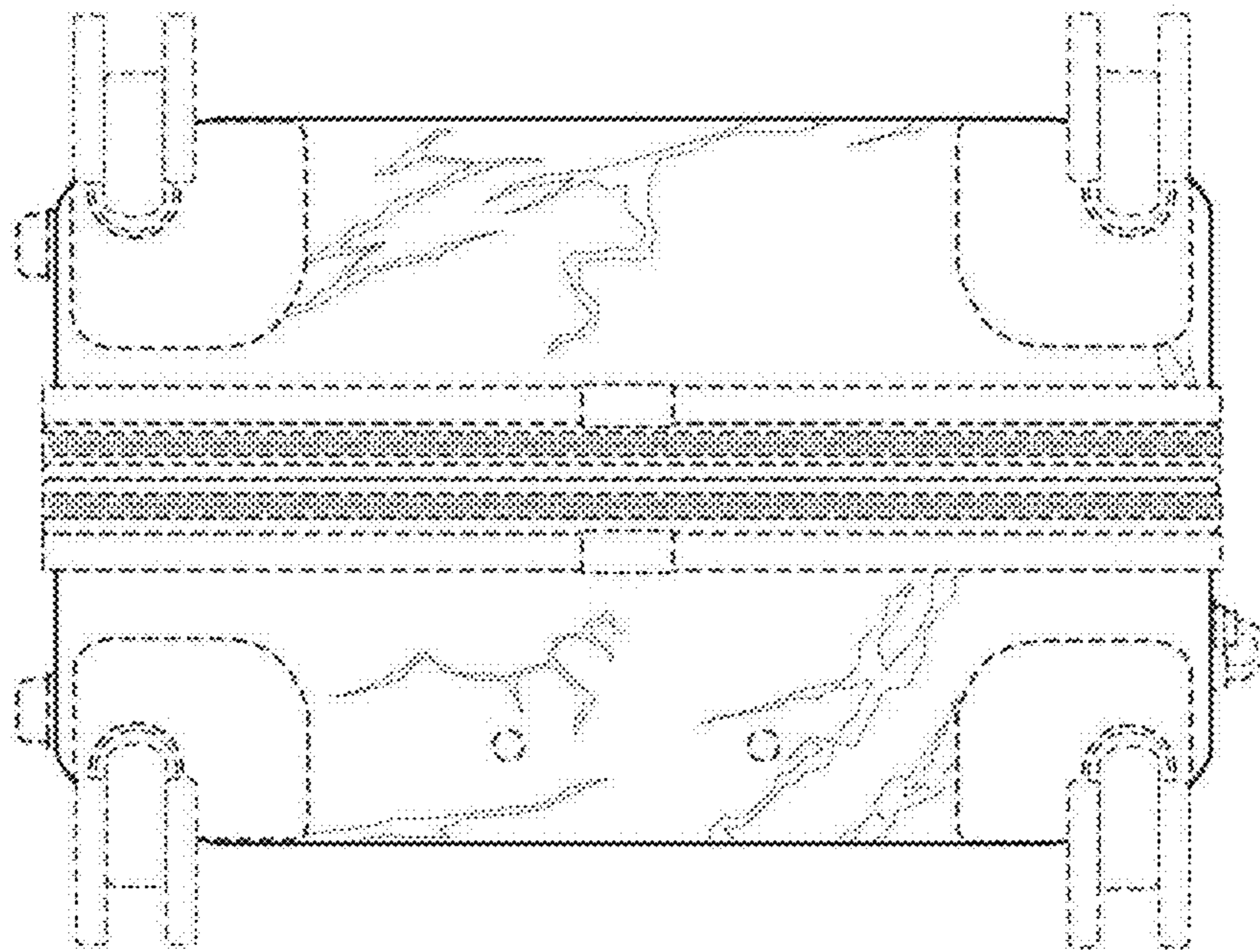

Fig. 16

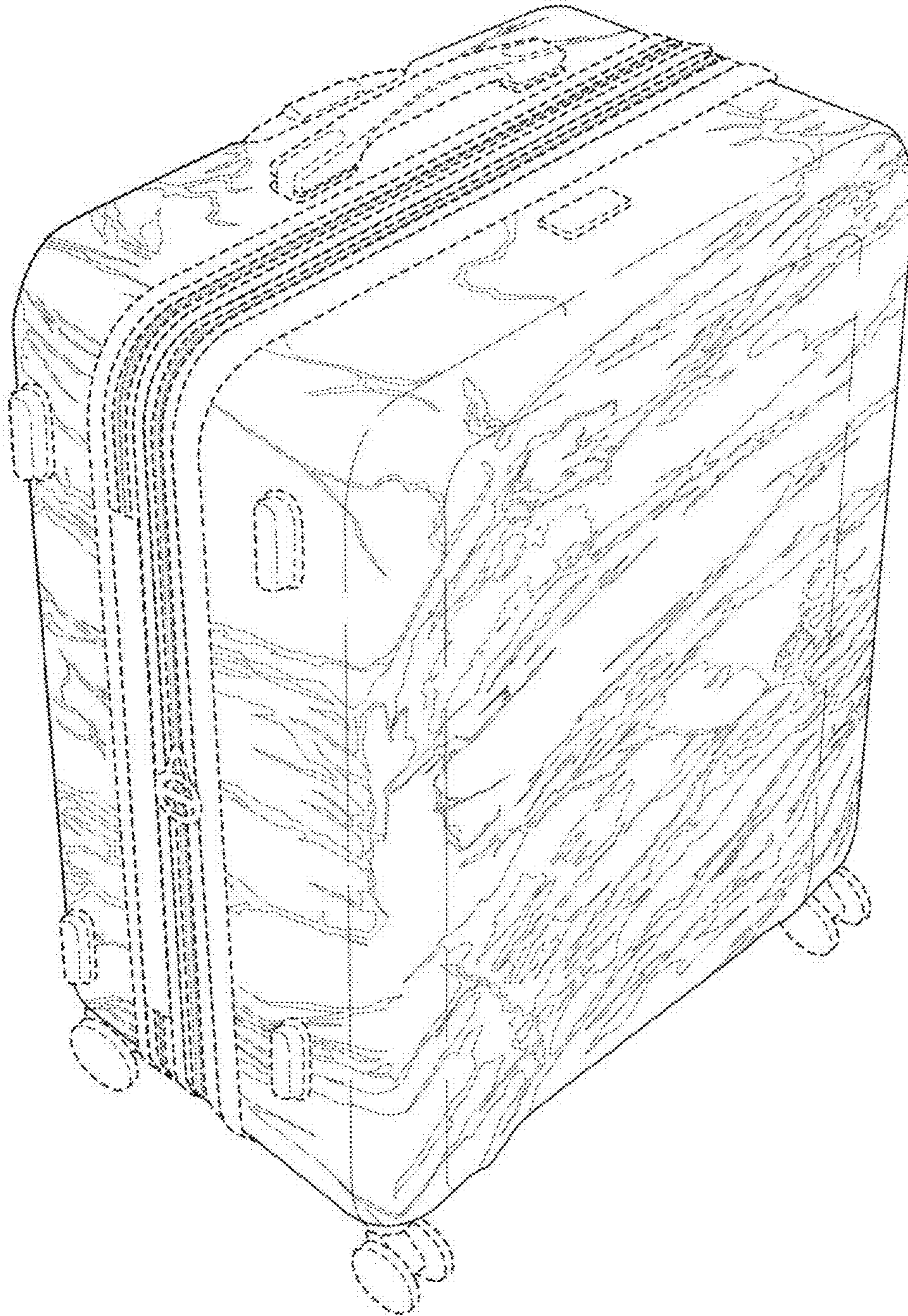

Fig. 17

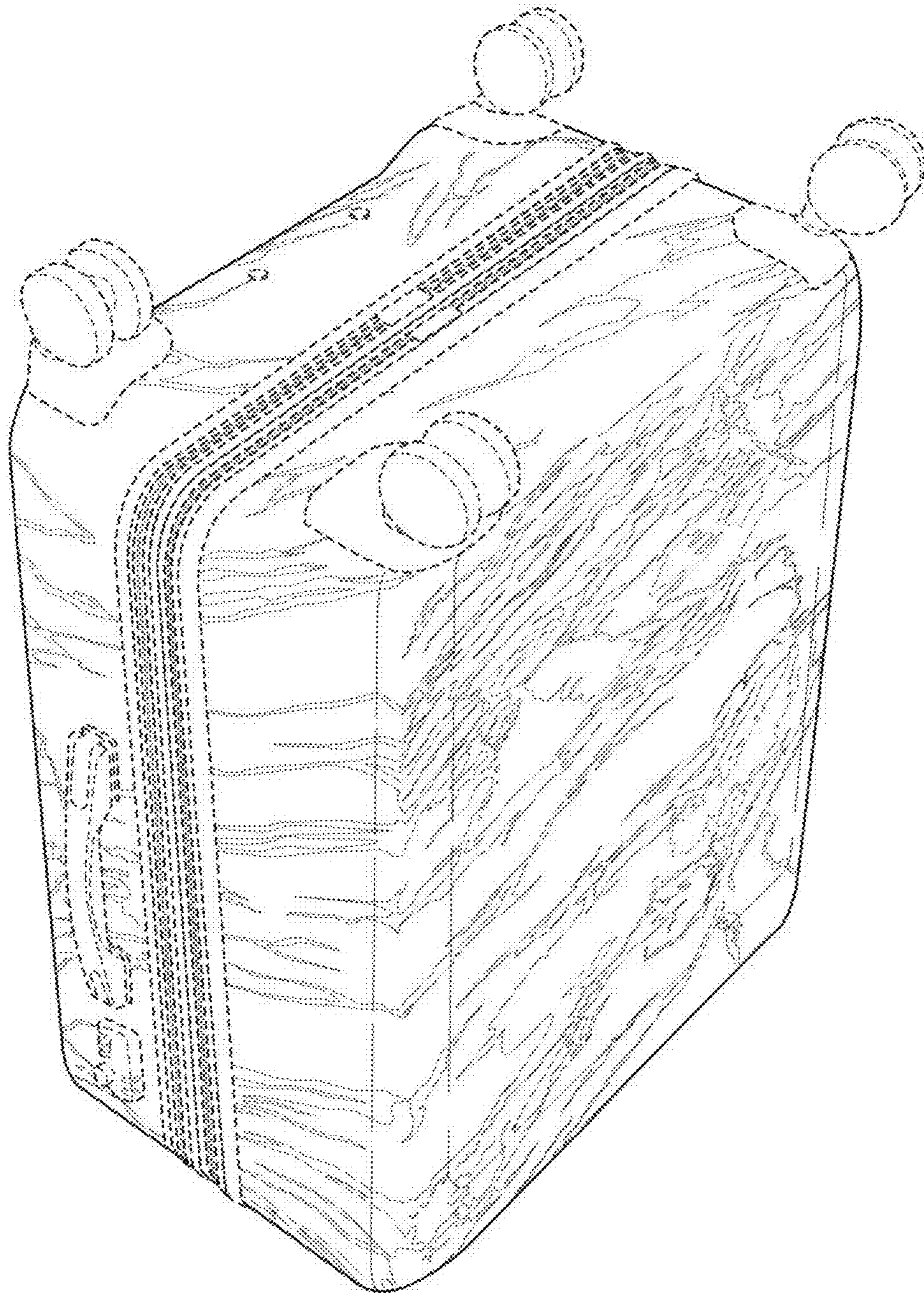

Fig. 18

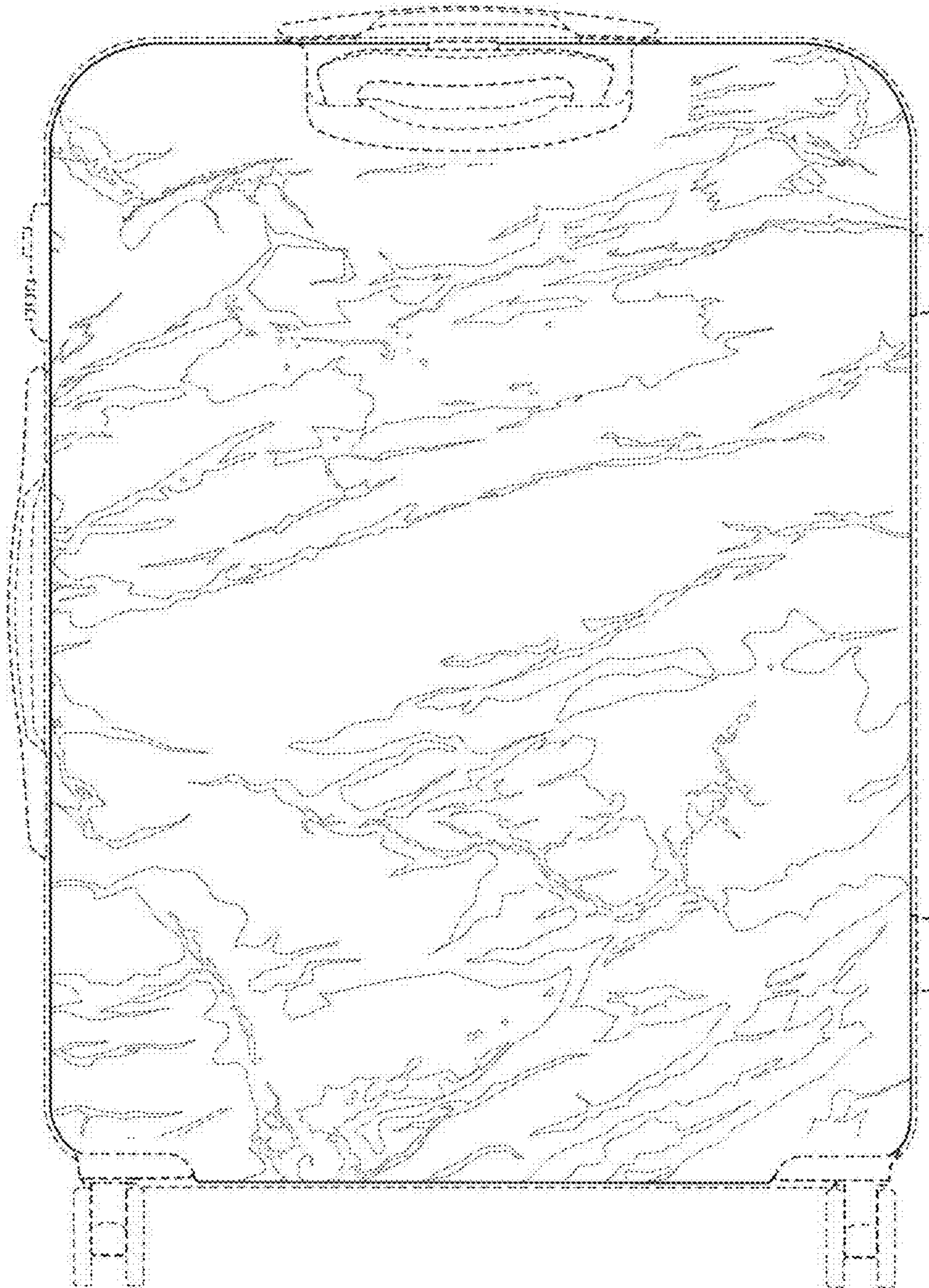

Fig. 19

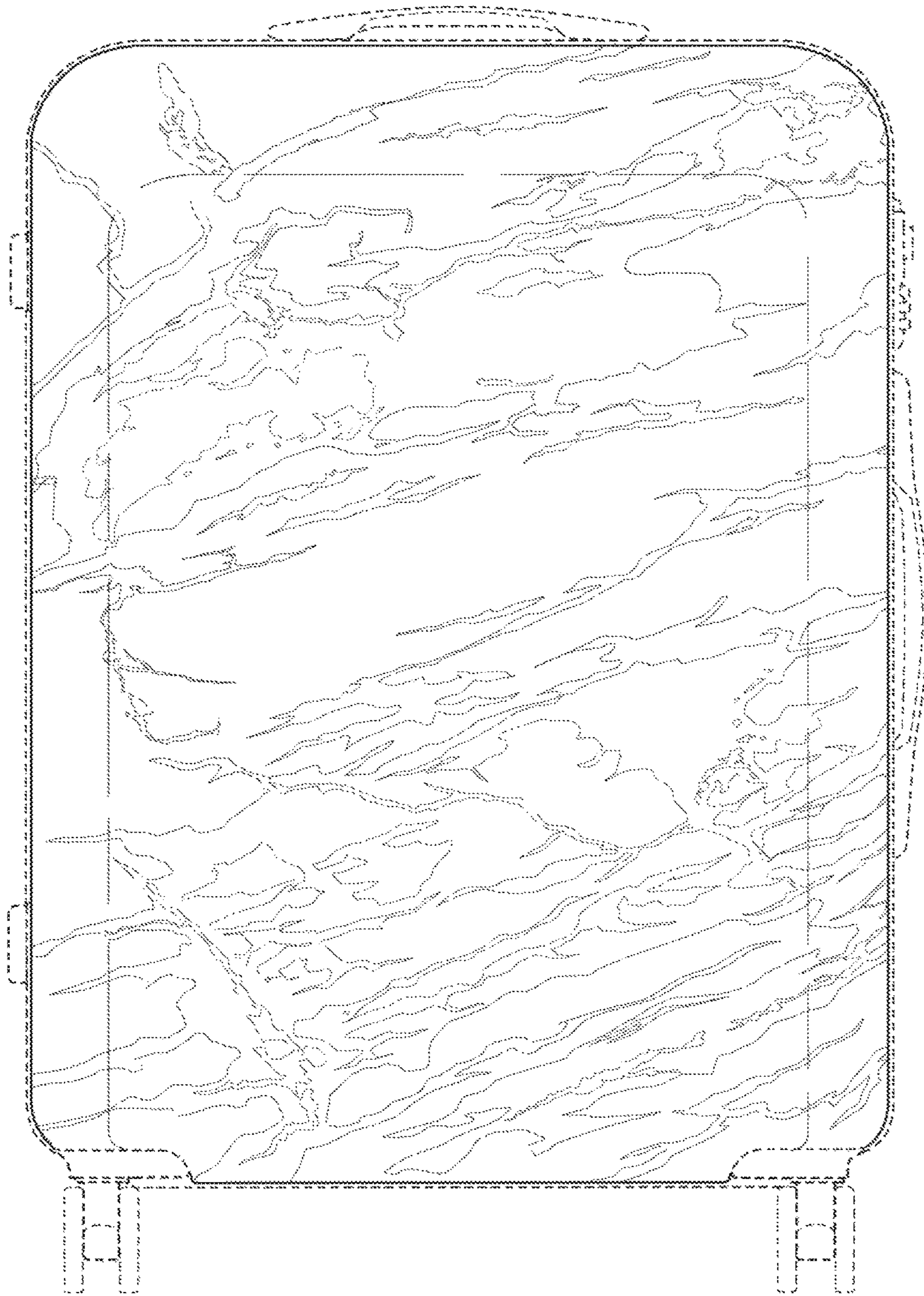

Fig.20

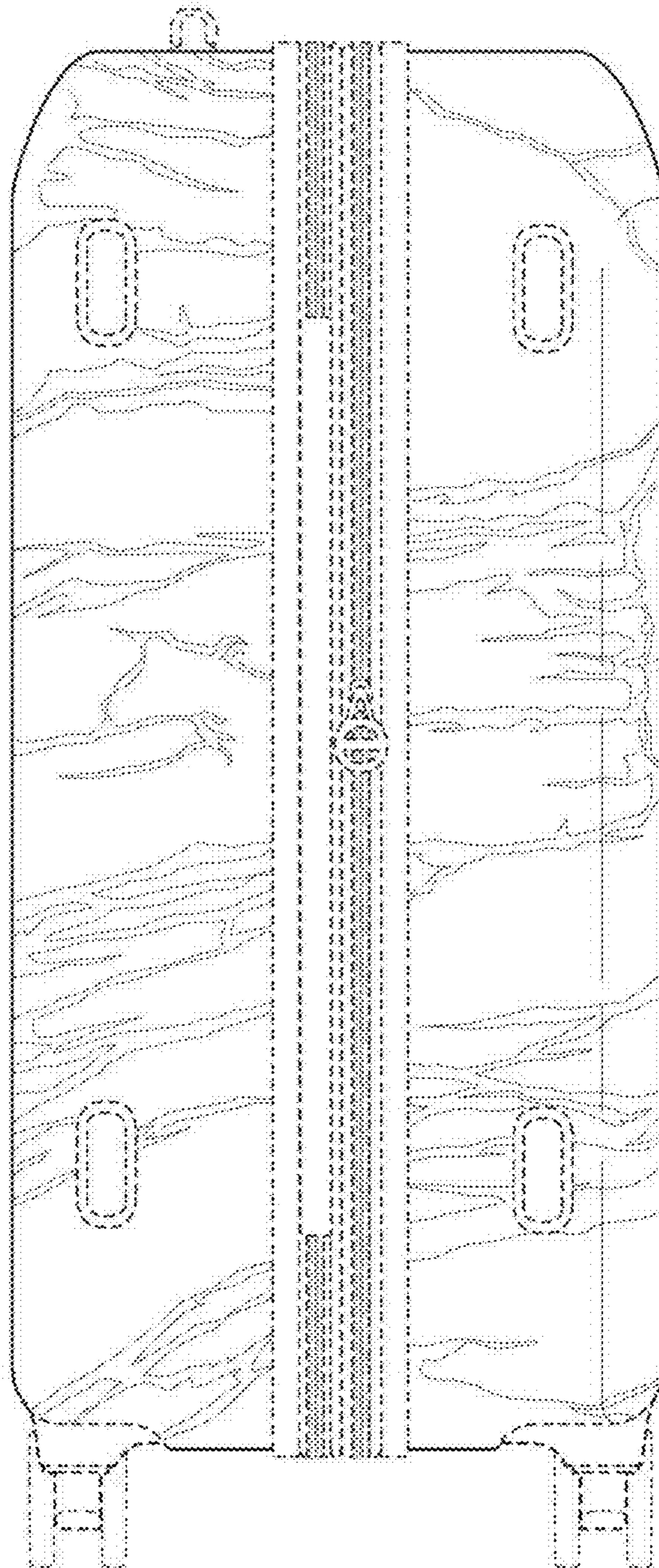

Fig.21

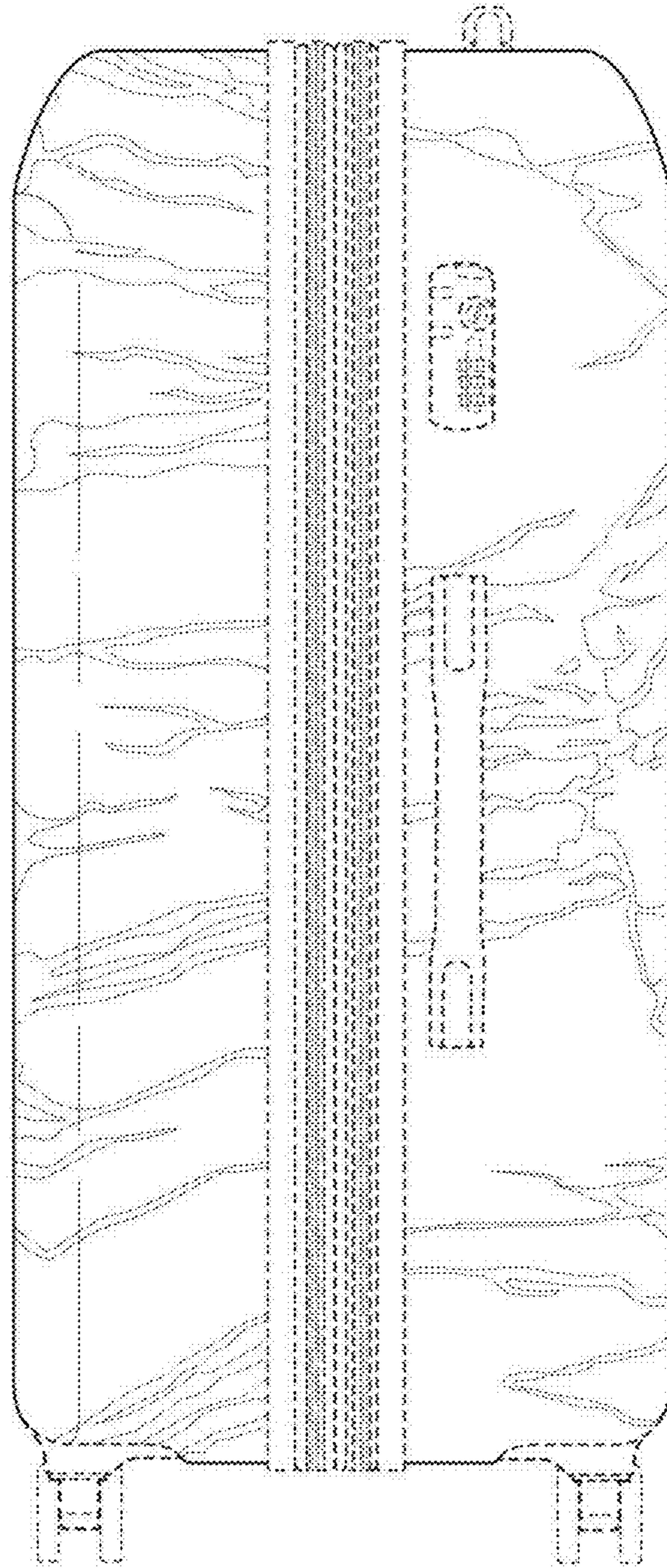

Fig.22



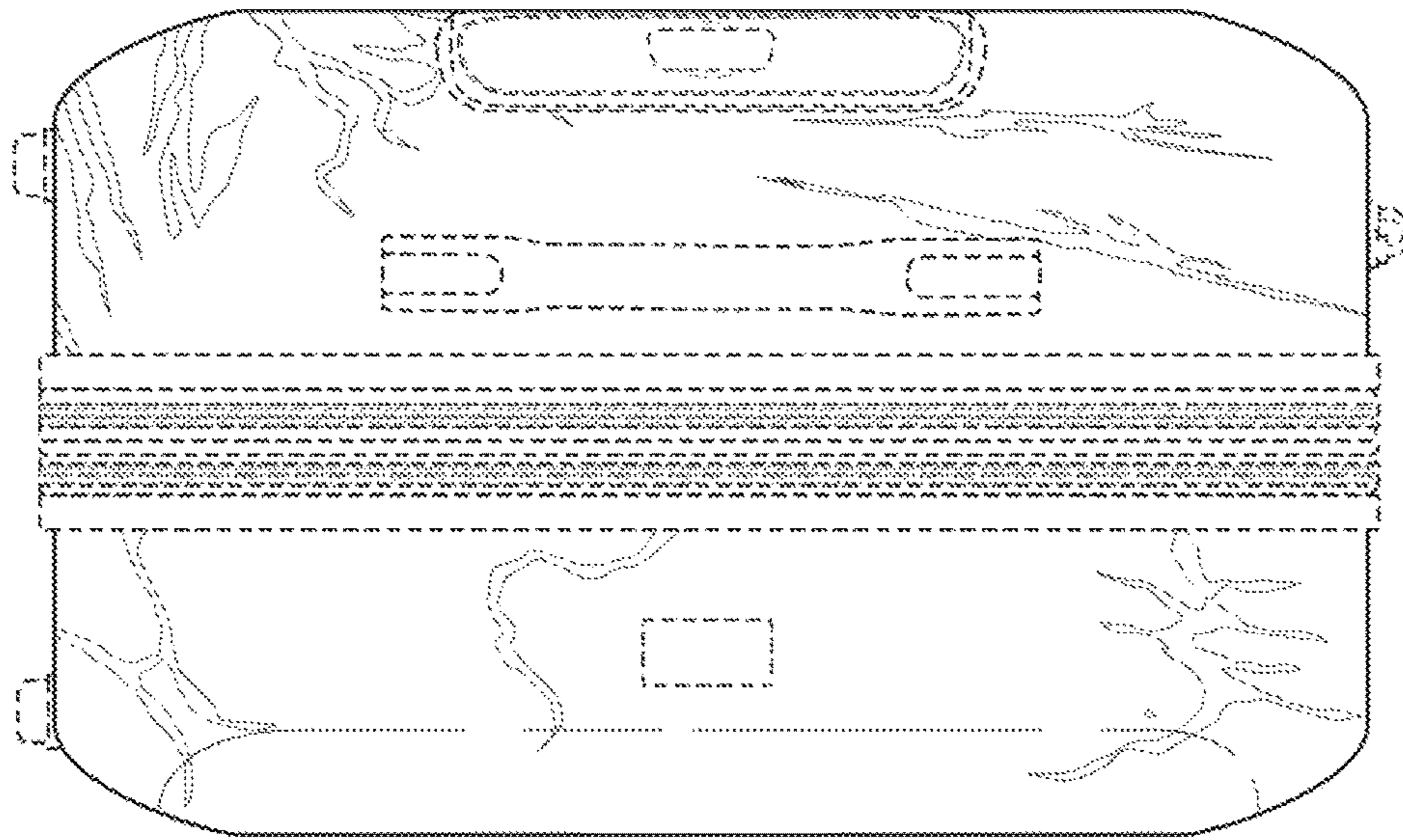

Fig.23

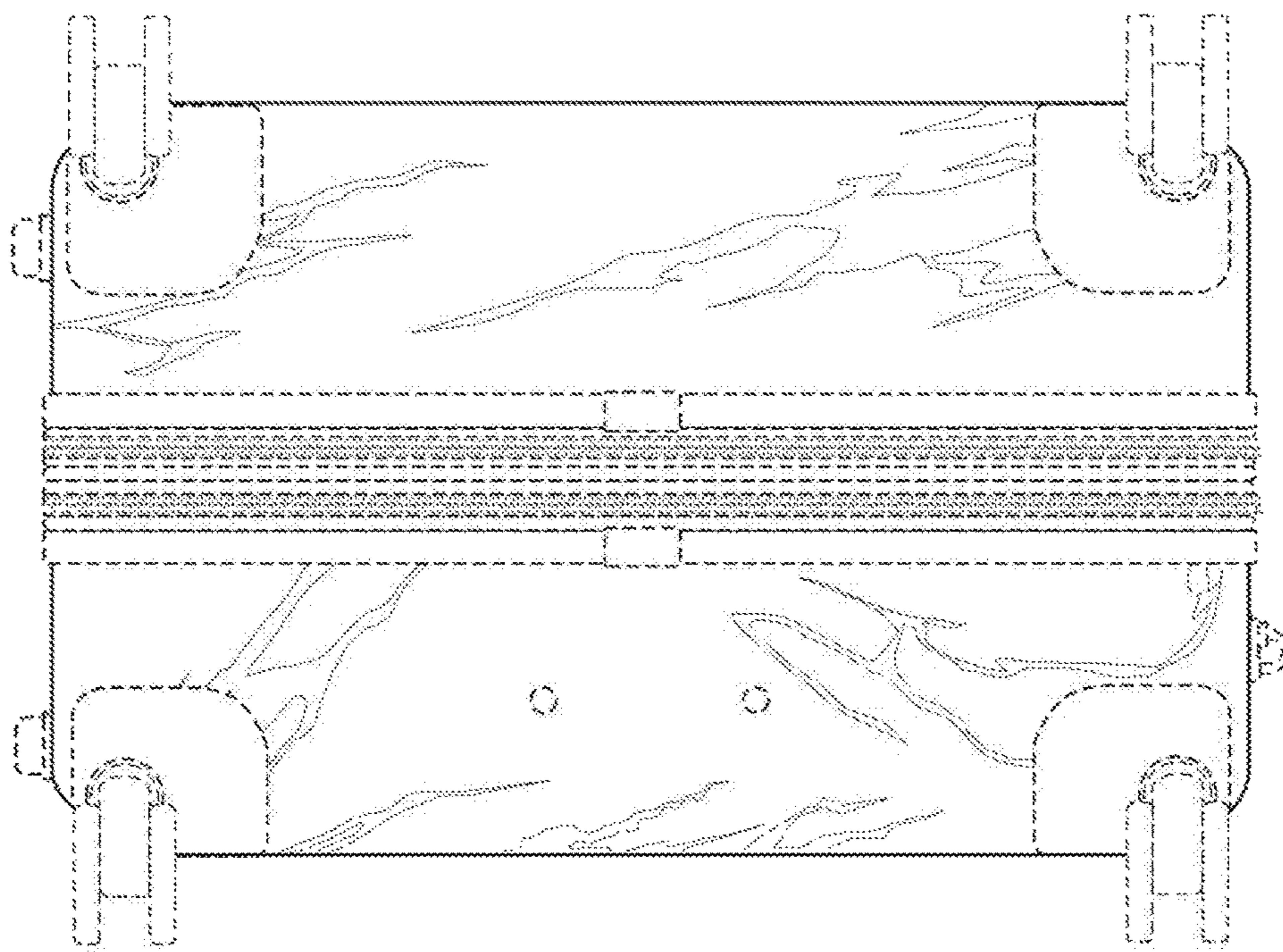

Fig.24