



US00D818707S

(12) **United States Design Patent**
Vevers et al.

(10) **Patent No.:** **US D818,707 S**
(45) **Date of Patent:** **** May 29, 2018**

(54) **HAND BAG**

(71) Applicant: **Coach, Inc.**, New York, NY (US)

(72) Inventors: **Stuart Vevers**, New York, NY (US);
Hae Young Kim, New York, NY (US)

(73) Assignee: **Coach IP Holdings LLC**, New York,
NY (US)

(**) Term: **15 Years**

(21) Appl. No.: **29/593,795**

(22) Filed: **Feb. 13, 2017**

(51) **LOC (11) Cl.** **03-01**

(52) **U.S. Cl.**
USPC **D3/246**

(58) **Field of Classification Search**
USPC D3/232–233, 240–243, 245–246, 318
CPC A45C 1/024; A45C 3/06
See application file for complete search history.

(56) **References Cited**

U.S. PATENT DOCUMENTS

D611,706 S *	3/2010	Angles	D3/243
D655,501 S *	3/2012	Maier	D3/245
D684,767 S *	6/2013	Gerbi	D3/246
D762,976 S *	8/2016	Maier	D3/246

* cited by examiner

Primary Examiner — Holly H Baynham

(74) *Attorney, Agent, or Firm* — Honigman Miller
Schwartz and Cohn LLP

(57) **CLAIM**

The ornamental design for a hand bag, as shown and described.

DESCRIPTION

FIG. 1 is a front-bottom perspective view of a hand bag, showing our new design;
 FIG. 2 is a rear-top perspective thereof;
 FIG. 3 is a front view thereof;
 FIG. 4 is a rear view thereof.
 FIG. 5 is a top plan view thereof;
 FIG. 6 is a bottom plan view thereof;
 FIG. 7 is a right side view thereof; and
 FIG. 8 is a left side view thereof.
 FIG. 9 is a front-bottom perspective view of another embodiment of the hand bag;
 FIG. 10 is a rear-top perspective thereof;
 FIG. 11 is a front view thereof;
 FIG. 12 is a rear view thereof.
 FIG. 13 is a top plan view thereof;
 FIG. 14 is a bottom plan view thereof;
 FIG. 15 is a right side view thereof; and
 FIG. 16 is a left side view thereof.
 The dashed lines in the drawings depict portions of the design that form no part of the claim.

1 Claim, 16 Drawing Sheets

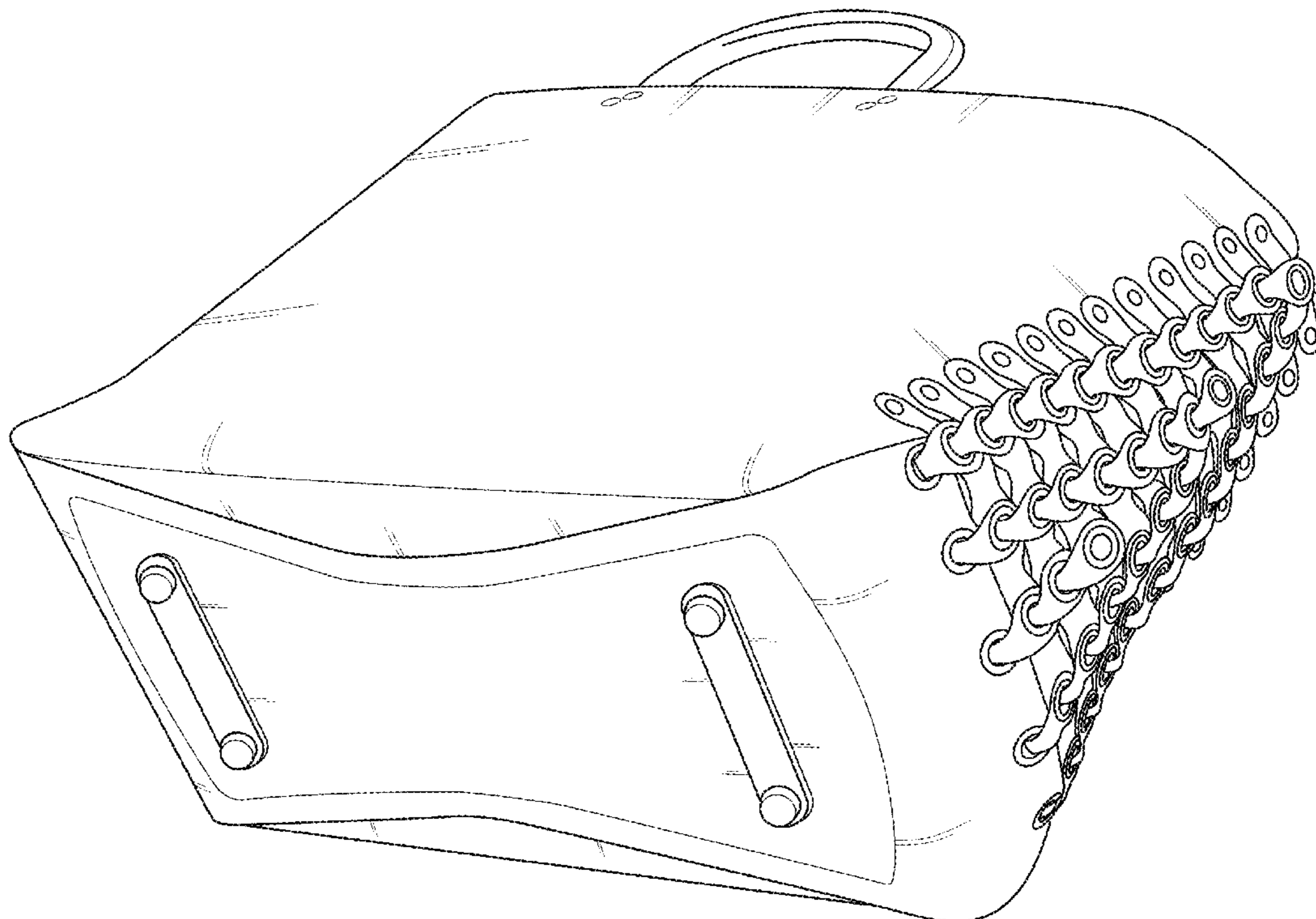

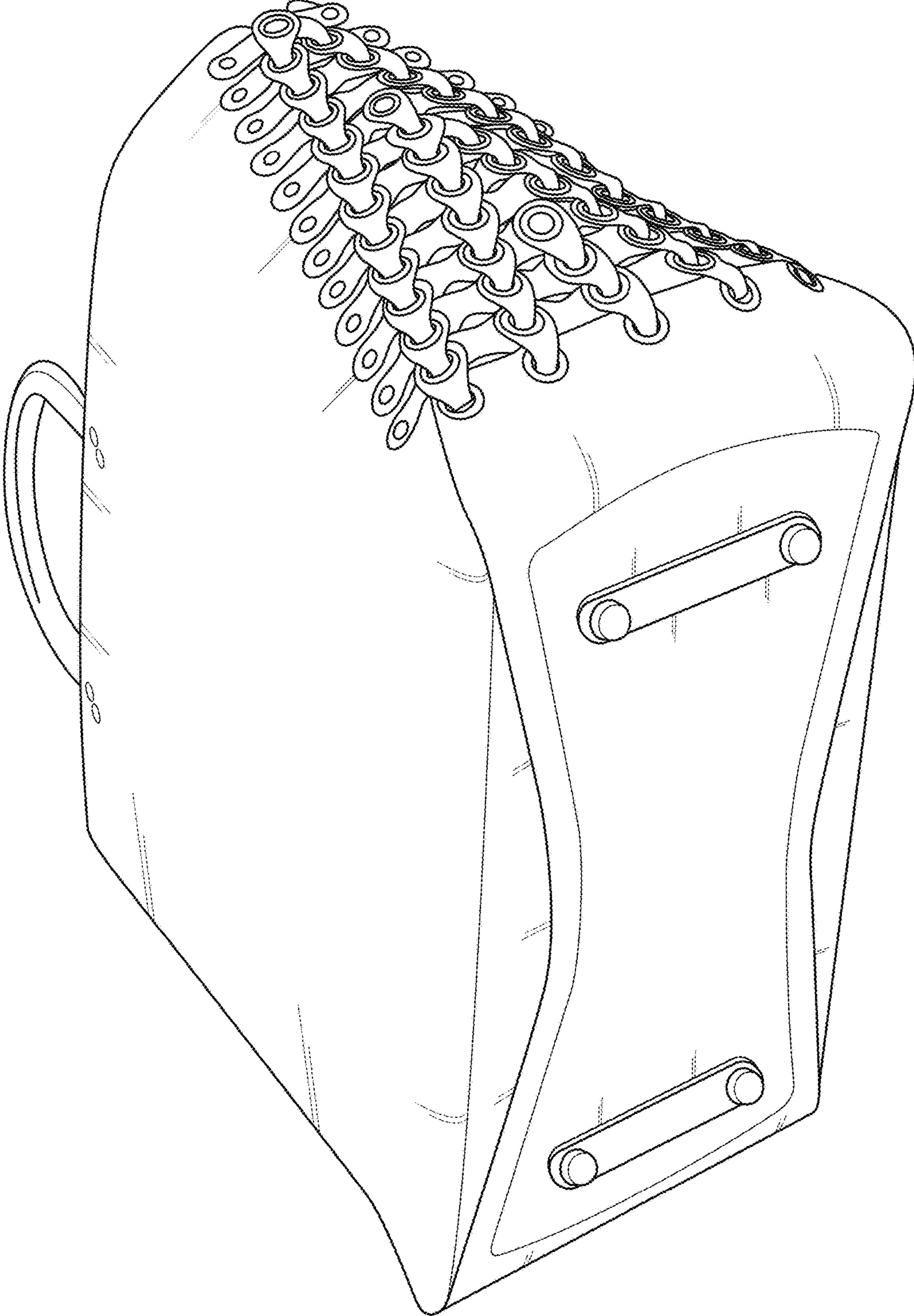

FIG. 1

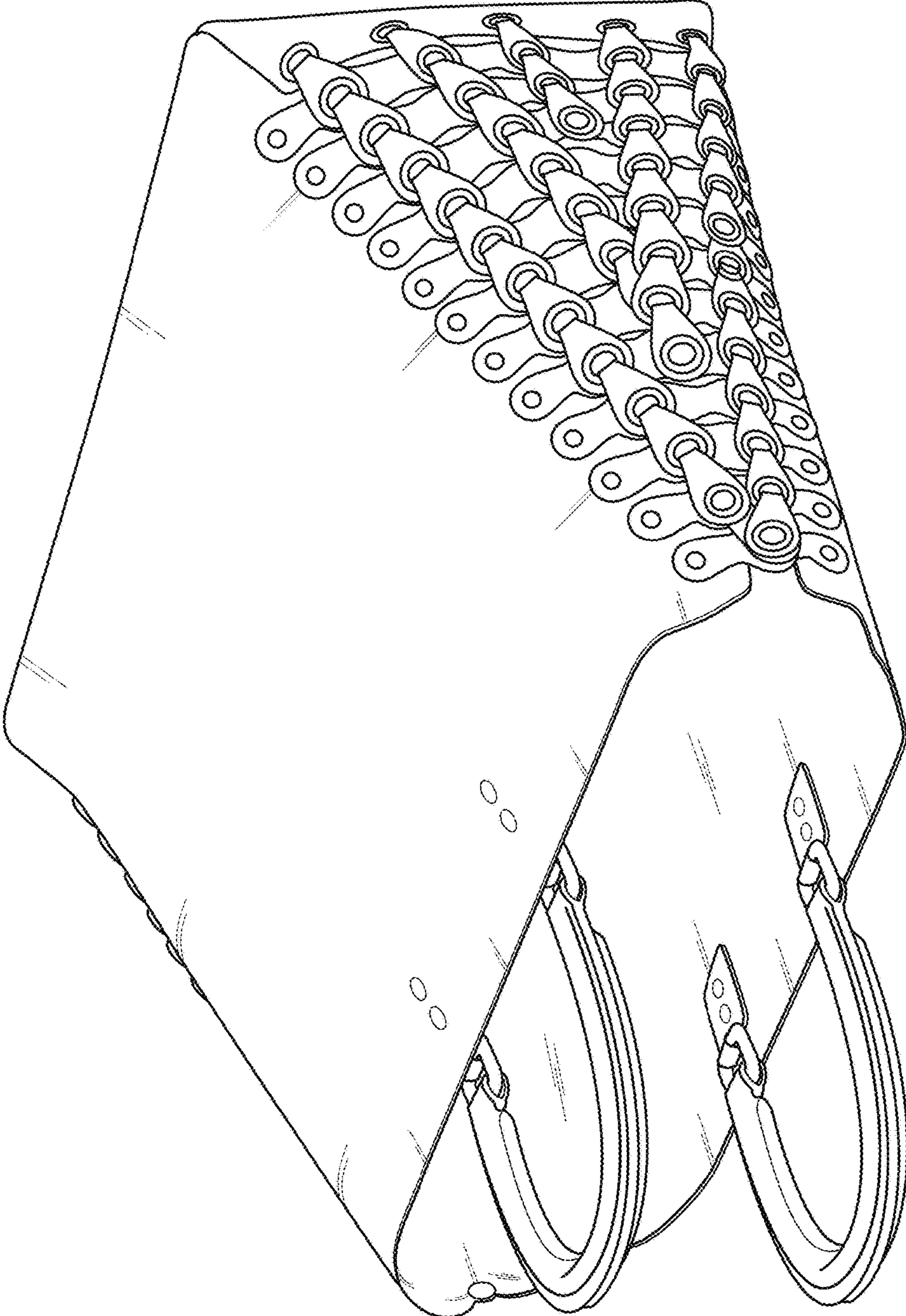

FIG. 2

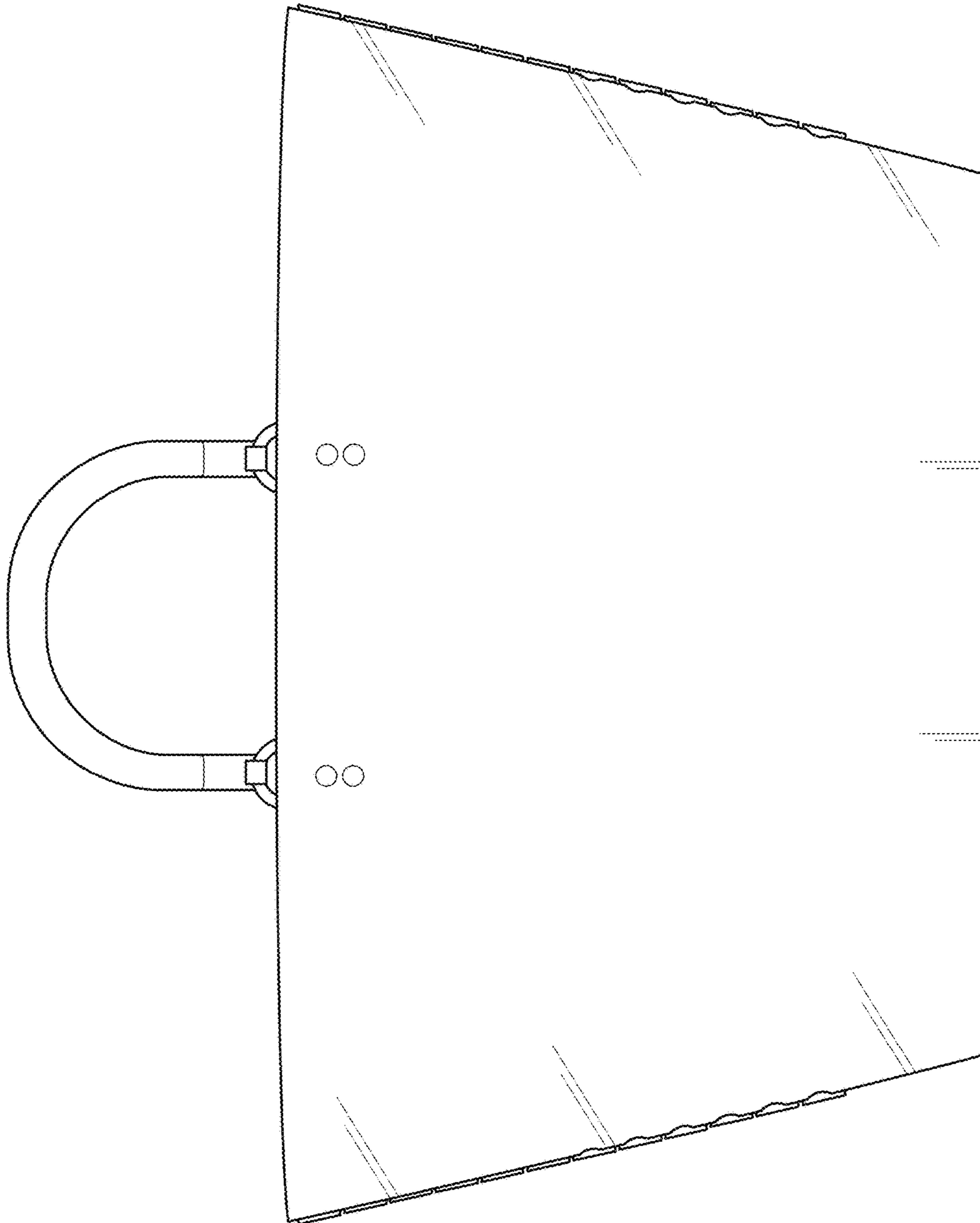

FIG. 3

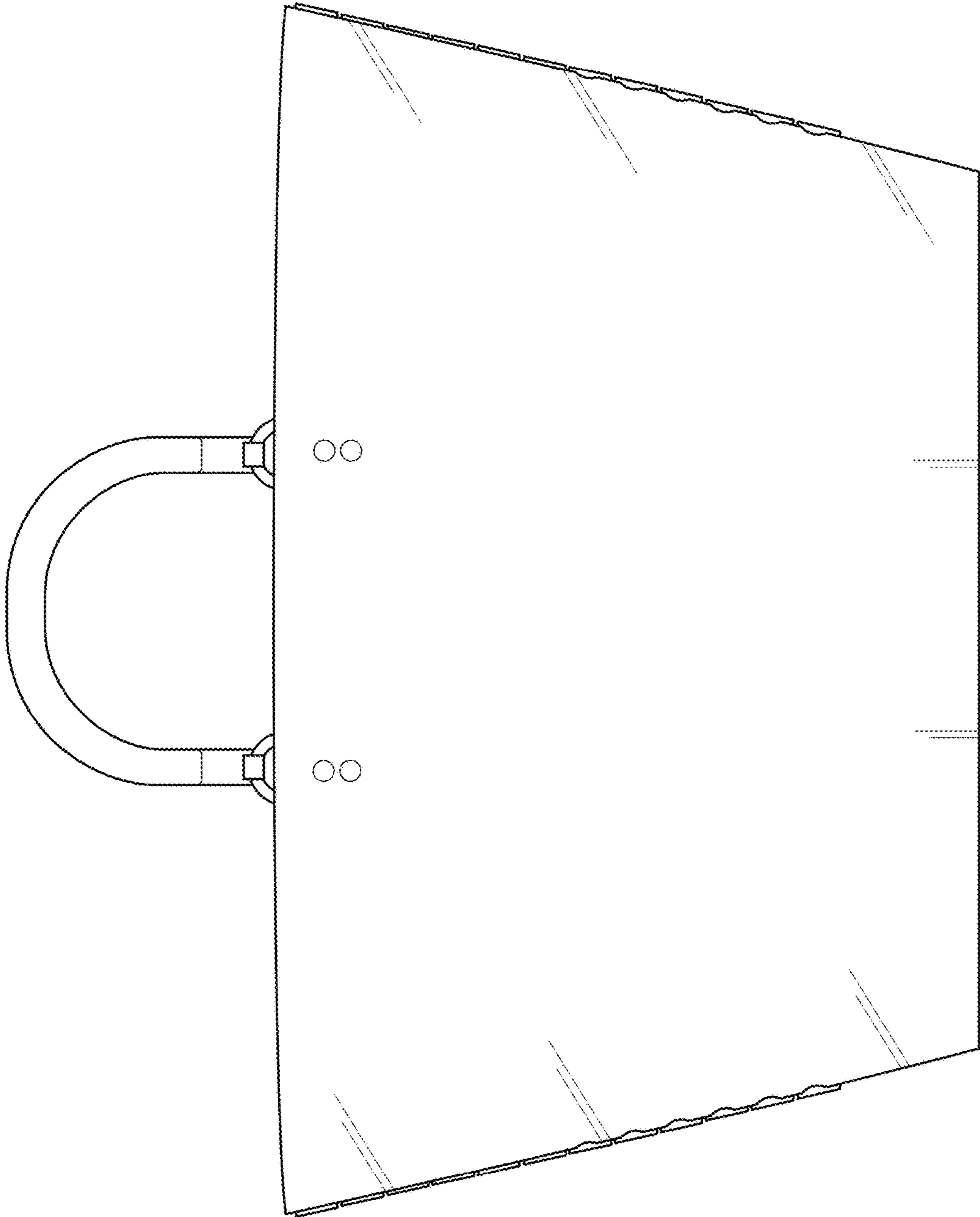

FIG. 4

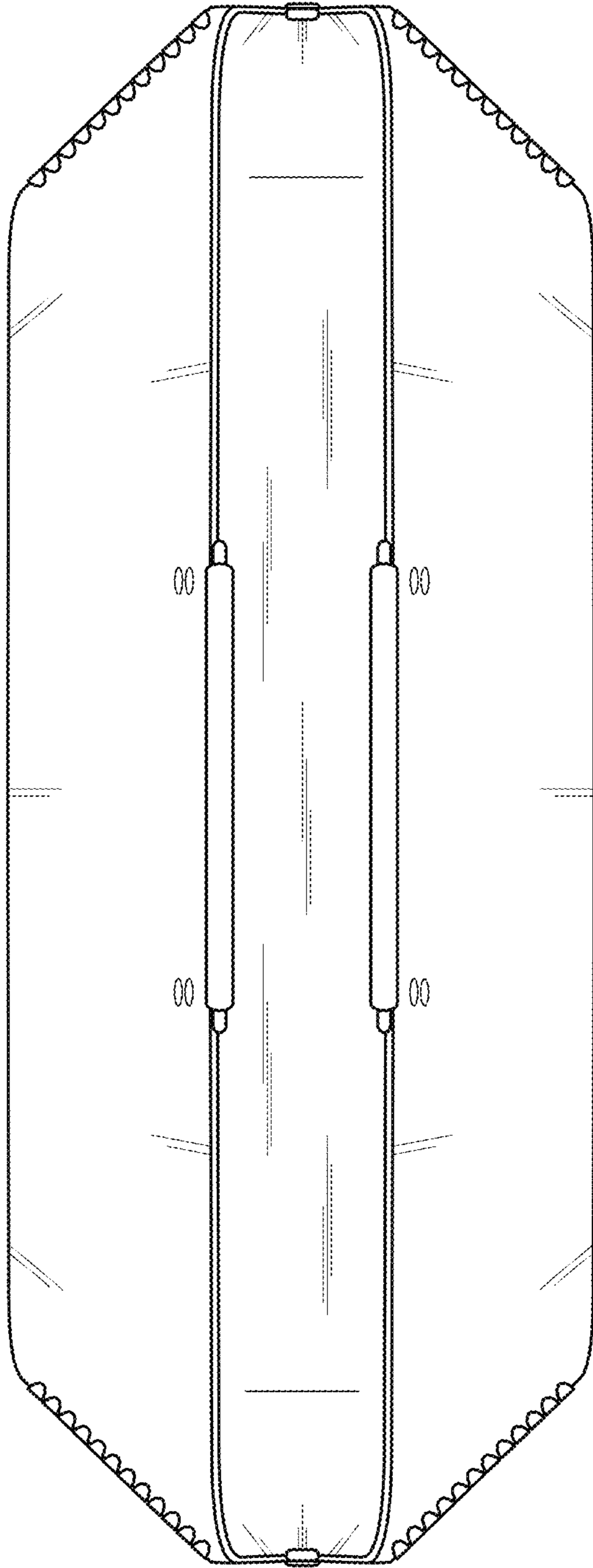

FIG. 5

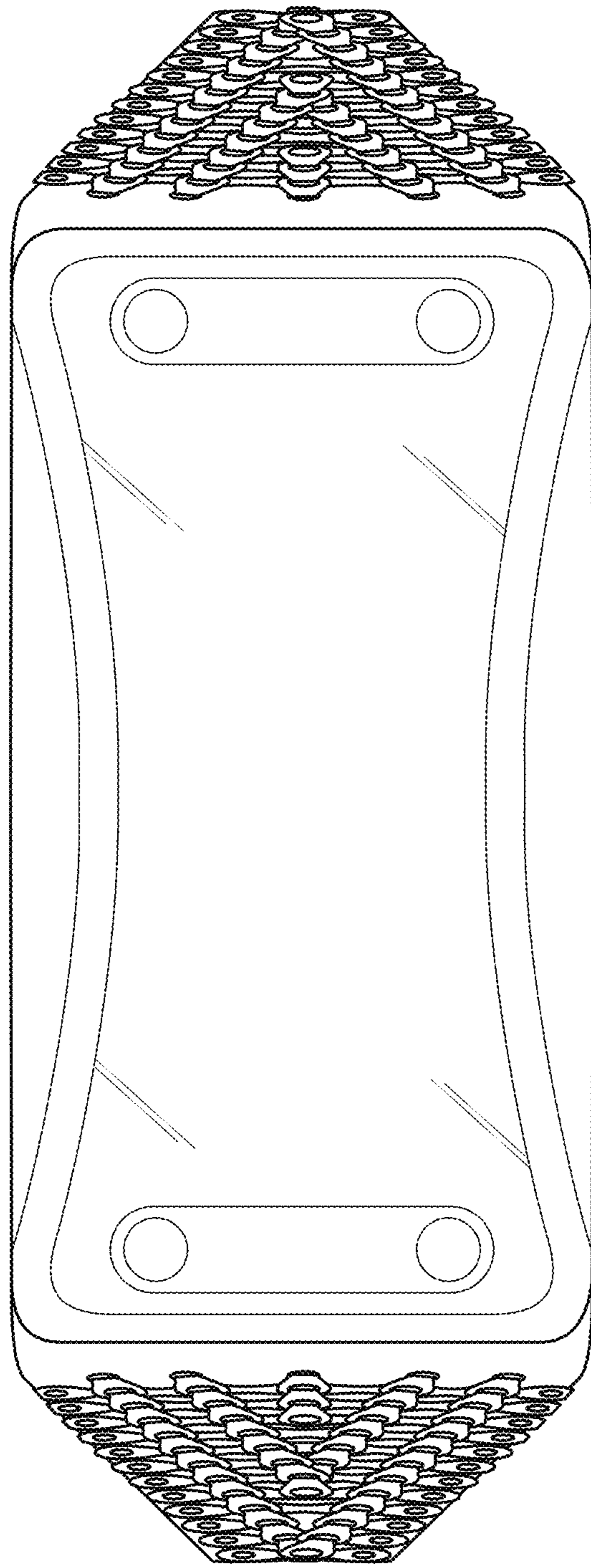

FIG. 6

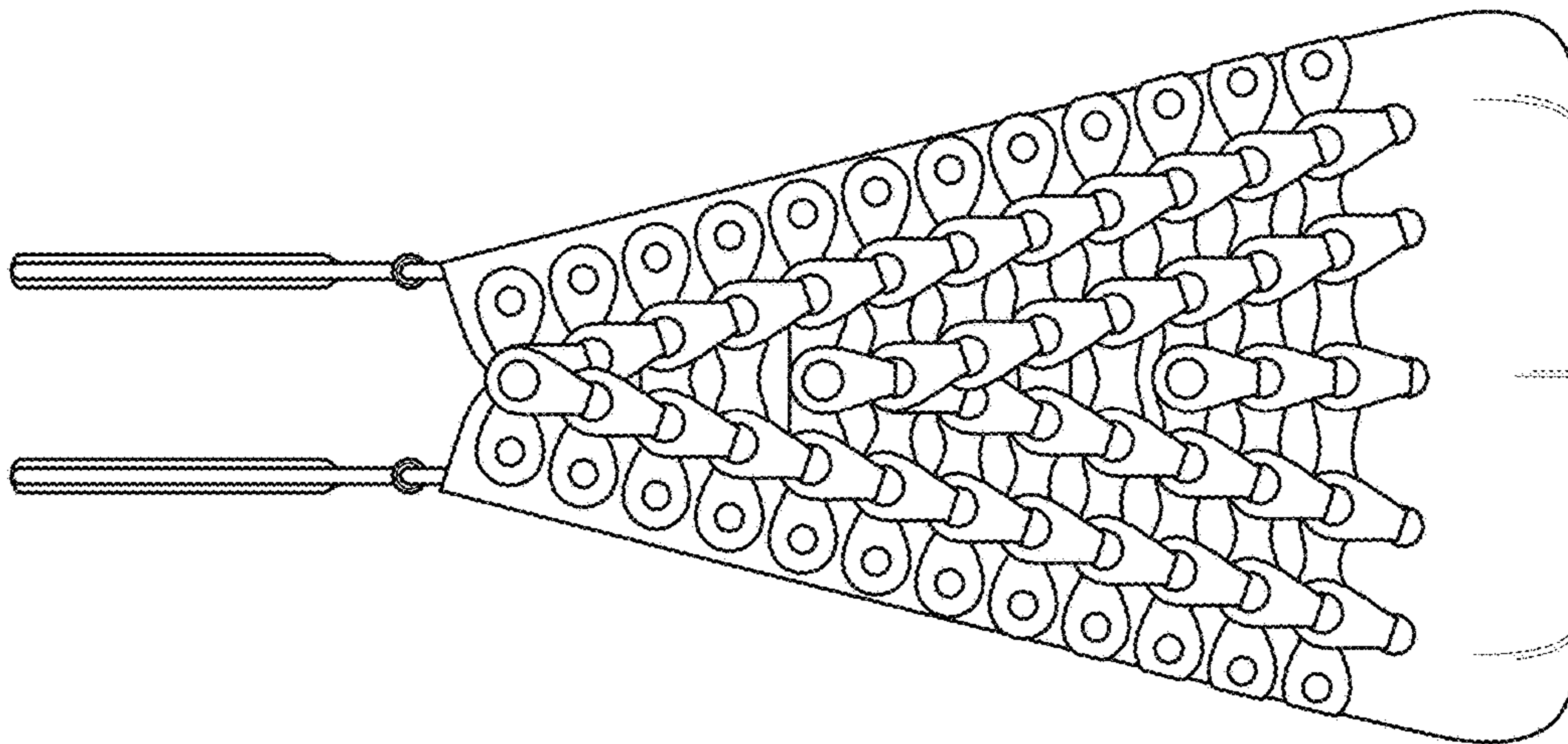

FIG. 7

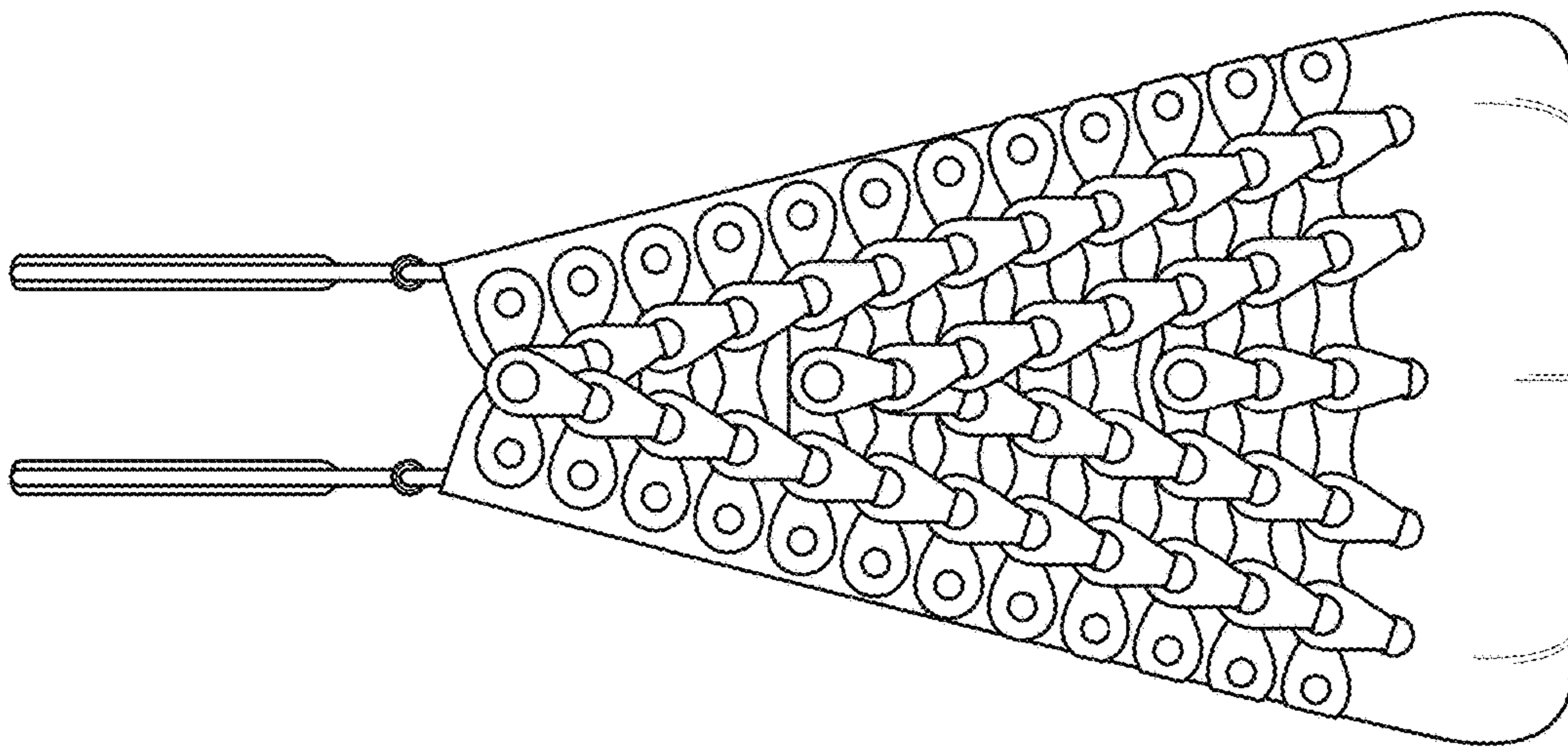

FIG. 8

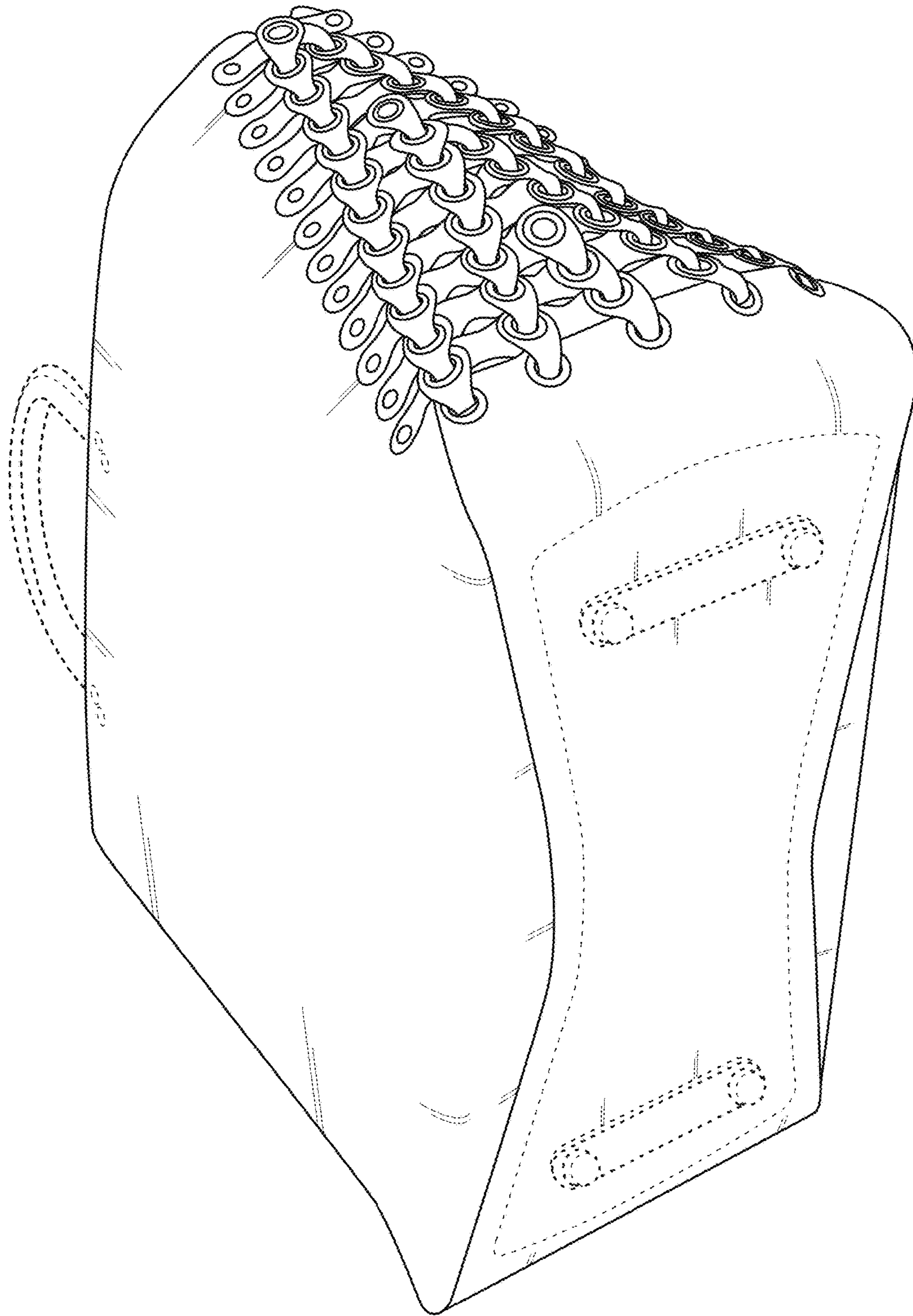

FIG. 9

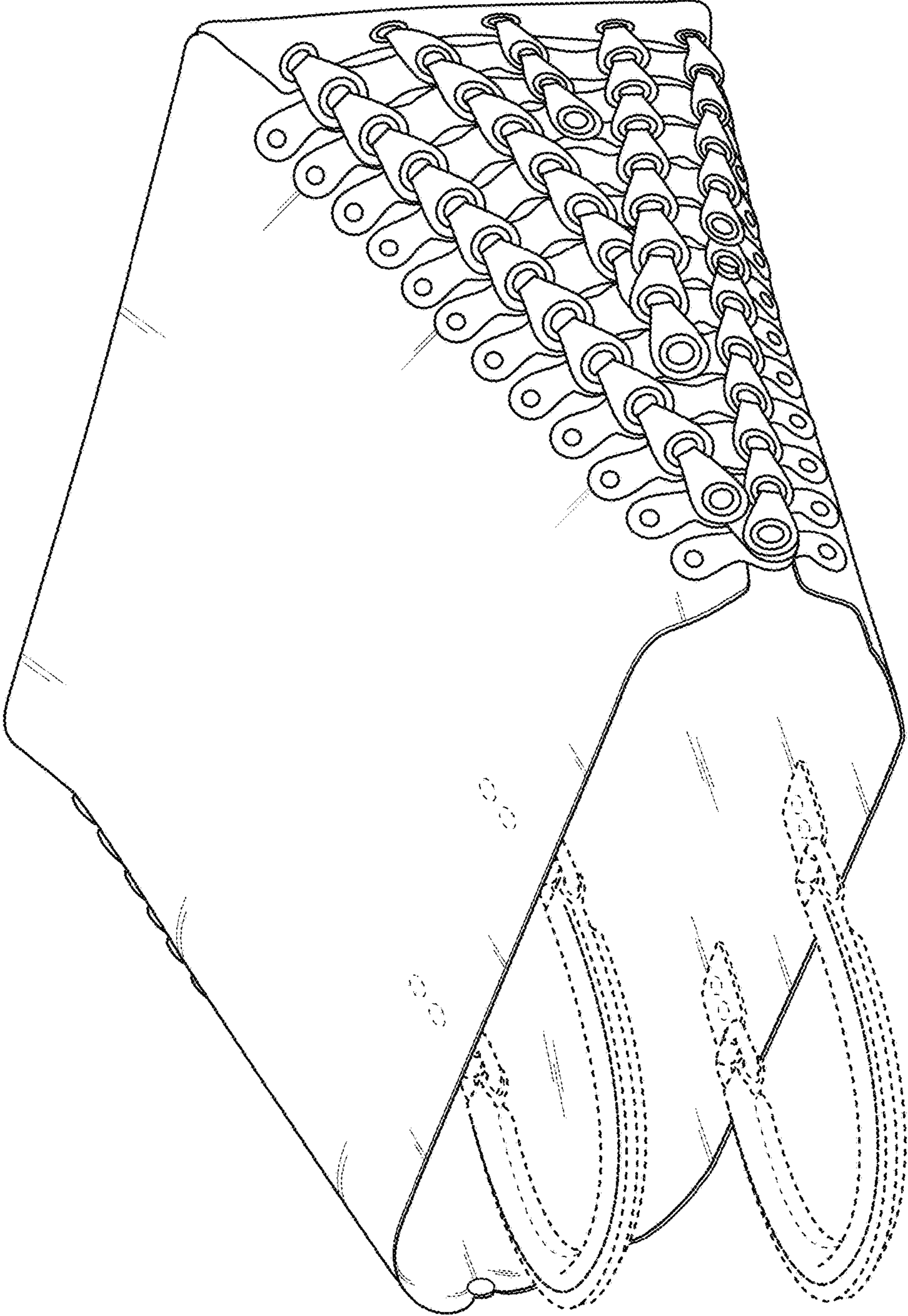

FIG. 10

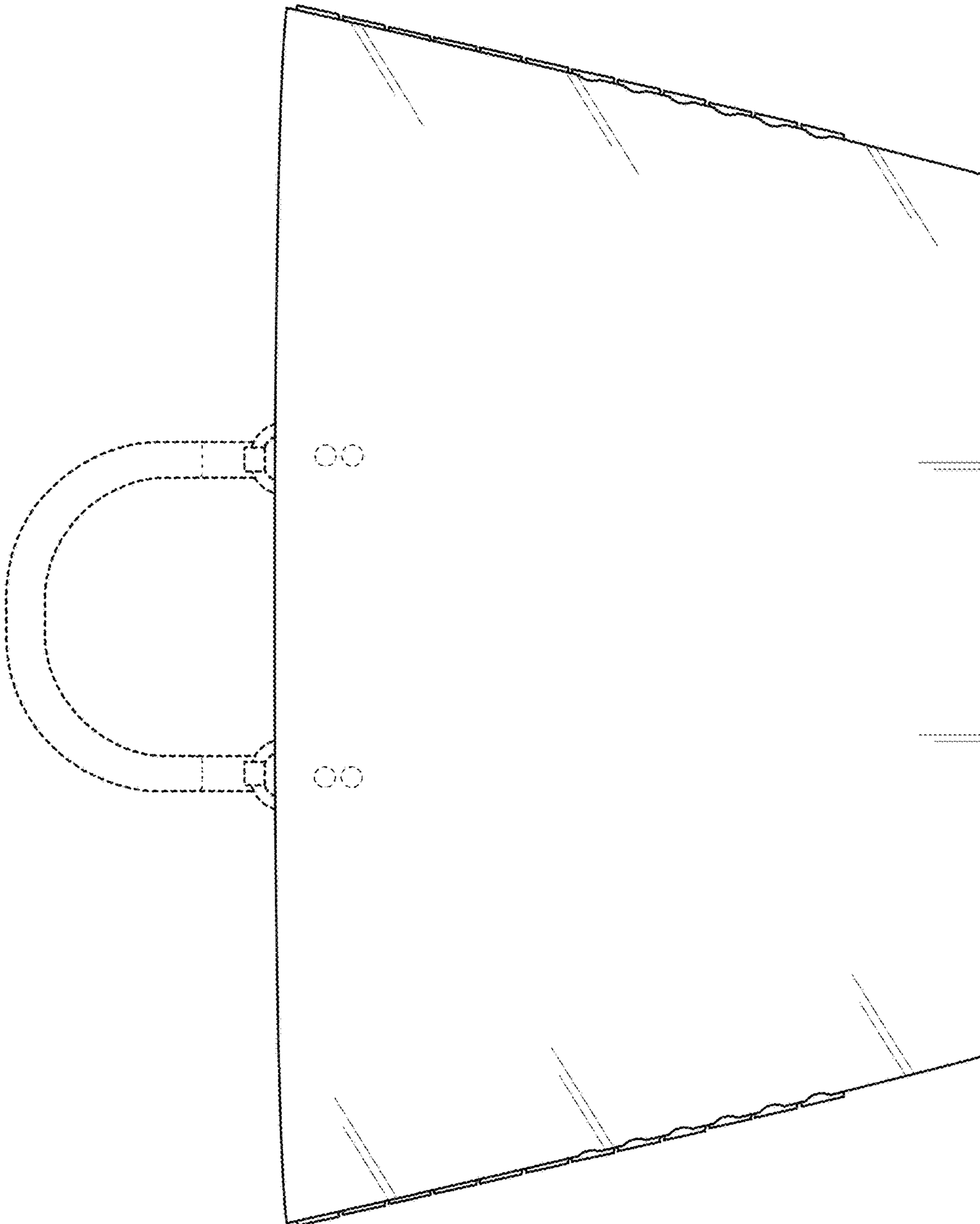

FIG. 11

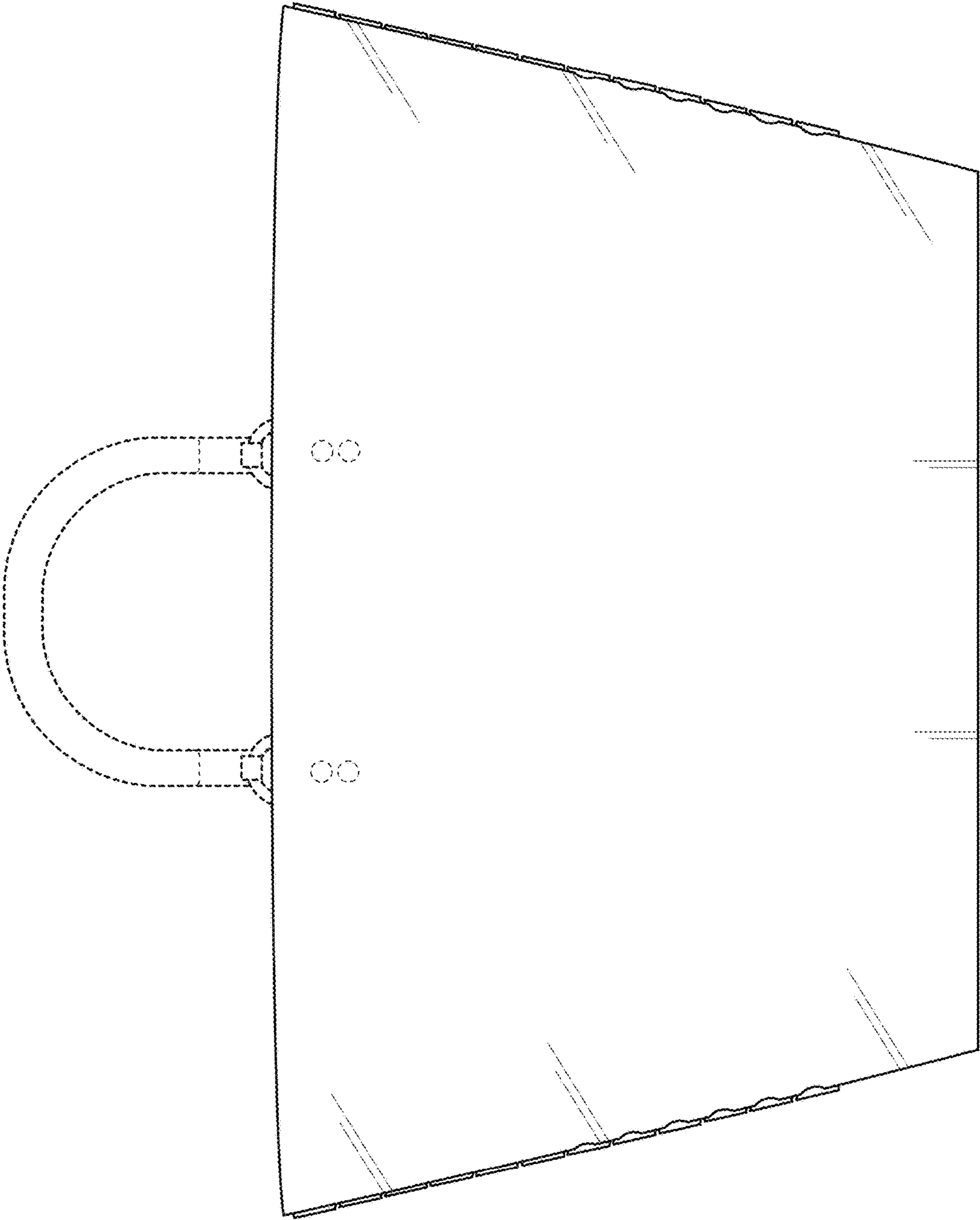

FIG. 12

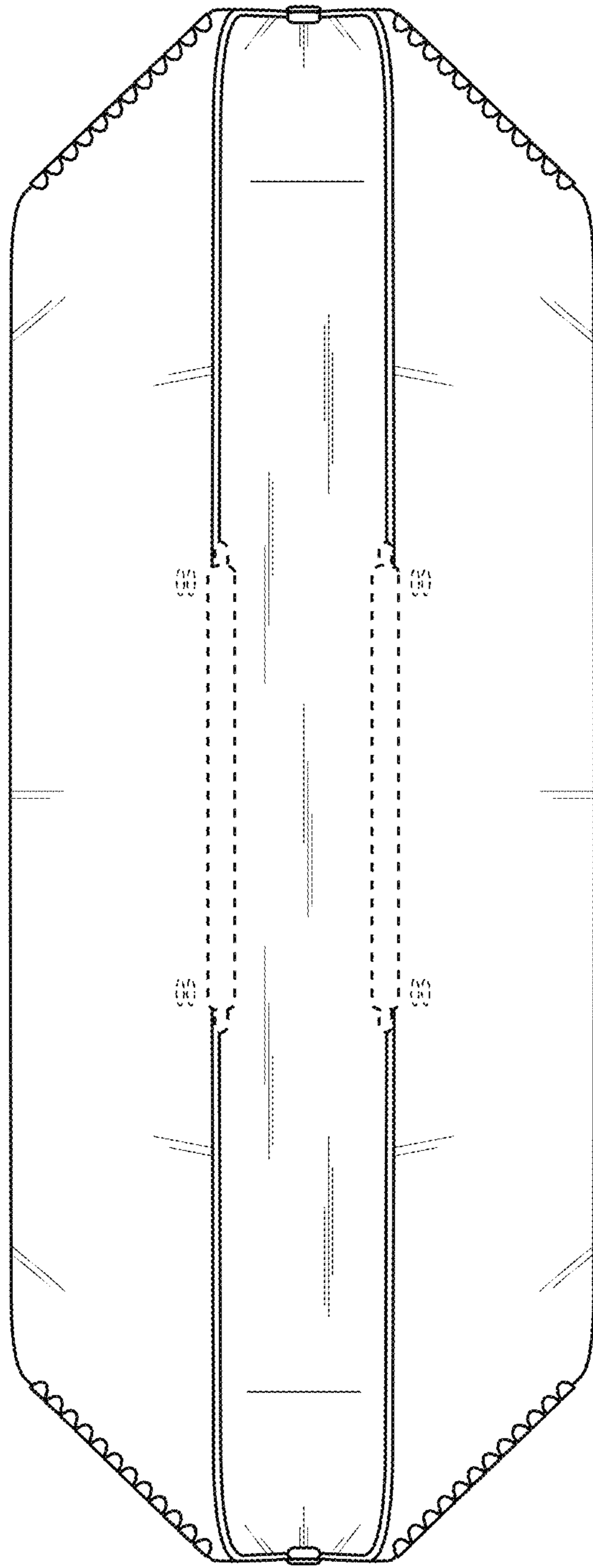

FIG. 13

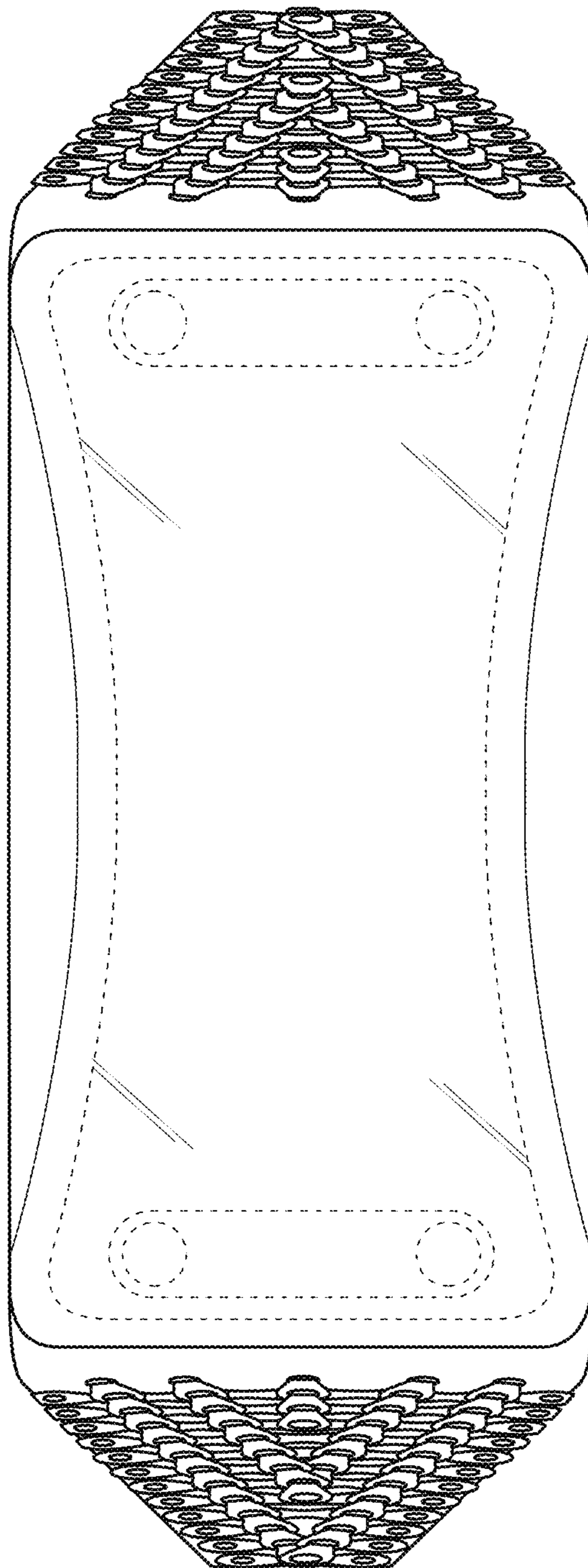

FIG. 14

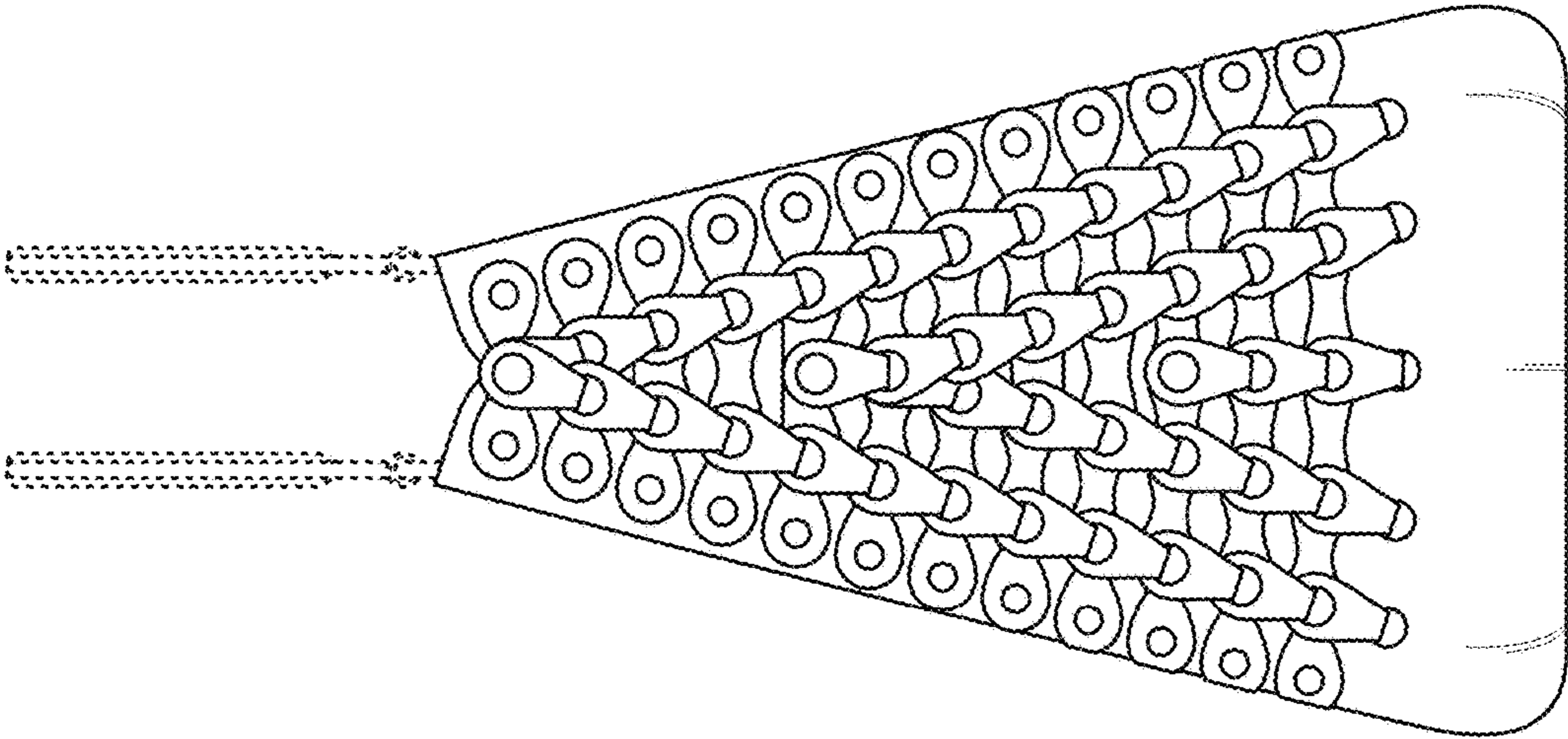

FIG. 15

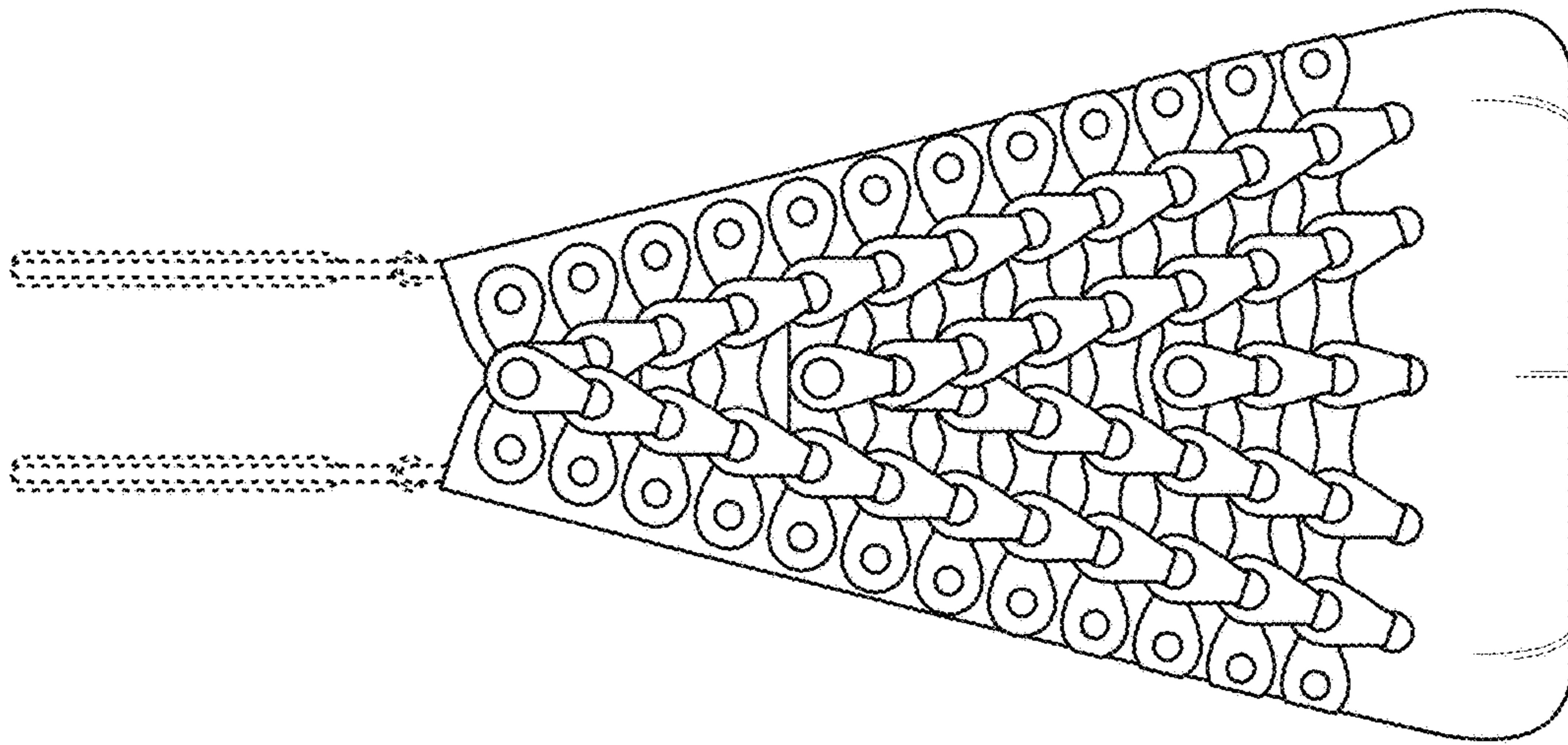

FIG. 16