



US00D818647S

(12) **United States Design Patent** (10) **Patent No.:** **US D818,647 S**
Babikian (45) **Date of Patent:** **** May 22, 2018**

(54) **SENSOR COVER ON HAND DRYER**

(71) Applicant: **BOBRICK WASHROOM EQUIPMENT, INC.**, North Hollywood, CA (US)

(72) Inventor: **Dikran Babikian**, Glendale, CA (US)

(73) Assignee: **BOBRICK WASHROOM EQUIPMENT, INC.**, North Hollywood, CA (US)

(**) Term: **14 Years**

(21) Appl. No.: **29/526,088**

(22) Filed: **May 6, 2015**

(51) **LOC (11) Cl.** **28-03**

(52) **U.S. Cl.**
USPC **D28/54.1**

(58) **Field of Classification Search**
USPC D28/12, 54.1, 58; 34/266, 201, 202;
392/381, 380; D23/357, 361, 385
CPC F26B 25/06
See application file for complete search history.

(56) **References Cited**

U.S. PATENT DOCUMENTS

4,073,460 A * 2/1978 Dale B43M 99/00
248/174
D274,803 S * 7/1984 Hughes D12/126
D327,001 S * 6/1992 Oosterhuis D8/373
D373,068 S * 8/1996 Airey D8/349
D375,038 S * 10/1996 Trevorrow D8/354
D400,081 S * 10/1998 Ibaragi D8/354
D422,886 S * 4/2000 Shea D8/354
6,340,145 B1 * 1/2002 Tagami A47B 21/0314
108/26
D455,755 S * 4/2002 Levine D14/447
D483,152 S * 12/2003 Martinuzzo D28/54.1
D598,272 S * 8/2009 Tejszerski D8/349
D633,149 S * 2/2011 Parshad D19/91

D654,063 S * 2/2012 Sergi D14/238
D664,299 S * 7/2012 Ishida D28/54.1
D668,379 S * 10/2012 Storey D26/138
D674,683 S * 1/2013 Shea D8/373
D690,188 S * 9/2013 Pontus D8/349
D701,215 S * 3/2014 King D14/447
D704,888 S * 5/2014 Robert D28/54.1
D705,040 S * 5/2014 Konrad D8/354
D710,032 S * 7/2014 Chrien D25/119
8,882,068 B2 * 11/2014 McGee B63B 49/00
248/300
D730,276 S * 5/2015 Wang D13/102

(Continued)

OTHER PUBLICATIONS

Curved Plane, How to Make a Curved Plane, Daz3D Forum, Daz3D.com, Sep. 2013.*

(Continued)

Primary Examiner — Zenia Bennett

(74) *Attorney, Agent, or Firm* — Lewis Roca Rothgerber Christie LLP

(57) **CLAIM**

The ornamental design for sensor cover on hand dryer, as shown and described.

DESCRIPTION

FIG. 1 is a top perspective view of my sensor cover on towel hand dryer design;
FIG. 2 is a bottom perspective view thereof;
FIG. 3 is a front view thereof;
FIG. 4 is a right side view, which is the same as the left side view, thereof;
FIG. 5 is a rear view thereof;
FIG. 6 is a top view thereof; and,
FIG. 7 is a bottom view thereof.
The broken lines in the drawings are for illustrative purposes only, and form no part of the claimed design.

1 Claim, 6 Drawing Sheets

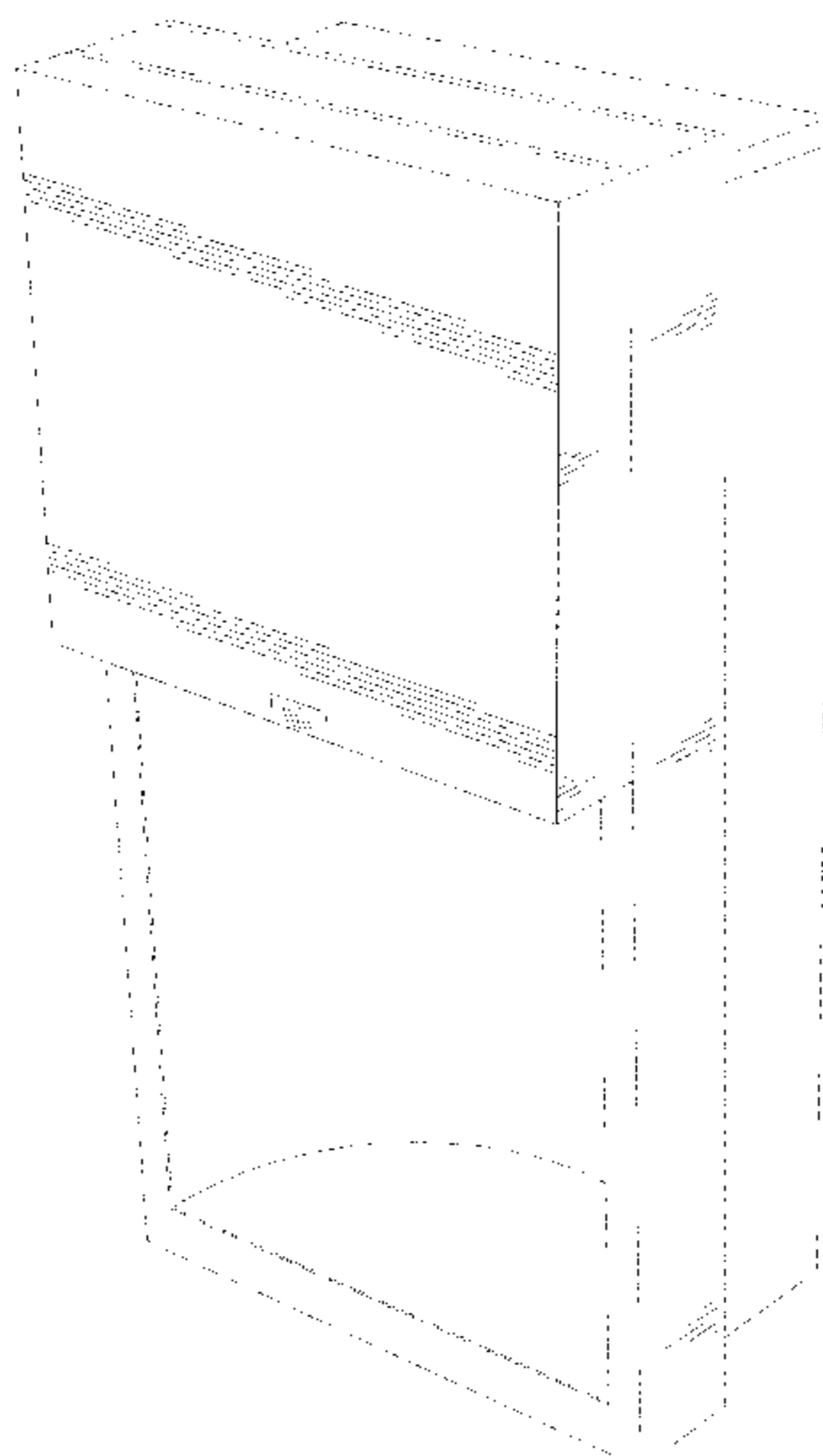

(56)

References Cited

U.S. PATENT DOCUMENTS

D739,709	S *	9/2015	Wright	D8/354
D742,591	S *	11/2015	Takiguchi	D28/54.1
D745,367	S *	12/2015	Mier	D8/349
D747,953	S *	1/2016	Thompson	D8/349
D769,698	S *	10/2016	Oltrogge	D8/349
2013/0104413	A1 *	5/2013	Akiyoshi	A47K 10/48 34/202
2014/0212304	A1 *	7/2014	Michael	F04D 25/082 417/363
2014/0250715	A1	9/2014	Babikian		

OTHER PUBLICATIONS

Hyco, Tornado Recessed Hand Dryers 2.6kW, <https://www.cnmonline.co.uk/tornado-recessed-hand-dryer-2-6kw.html>, printed Aug. 3, 2017, 2 pages.

Toto, TYC604 Hand Dryer Concealed, http://gb.toto.com/products/product-single-view/Product/show/Hand_Dryer-2/, printed Aug. 3, 2017, 2 pages.

Toto, HDR110 Hand Dryer, [http://www.restroomdirect.com/images/products/detail/Toto%20HDR110%20Hand%20Dryer%\(Unbranded\).jpg](http://www.restroomdirect.com/images/products/detail/Toto%20HDR110%20Hand%20Dryer%(Unbranded).jpg), printed Jun. 11, 2017, 1 page.

Puredry™ Cleanroom Hand and Glove Dryers; Germ-Free Recirculating Model No. 3333-33, <https://www.terrauniversal.com/cleanroom-equipment/puredry-hand-glove-dryer.php>, https://www.terrauniversal.com/gallery/oversized-images/Images/gowning-Hand-dryer-IMG_5686-1-700.jpg, printed Aug. 3, 2017, 5 pages.

Turbo-Tuff™ Fully Recessed Automatic High Speed Hand Dryer Model No. 0134, <http://americanspecialties.com/product/turbo-tuff-fully-recessed-high-speed-hand-dryer-0134/>, printed Aug. 3, 2017, 2 pages.

Zhejiang Aike, Automatic Recessed Hand Dryer AK2630E, <http://aikehanddryer.buy.disqueenfrance.com/iz54b46ed-automatic-recessed-hand-dryer-high-speed-stainless-steel>, http://img.dialqueenfrance.com/nimg/42/78/c9a79b7269ee7cf7a2b0ad4463c9-600x600-0/automatic_recessed_hand_dryer_high_speed_stainless_steel.jpg, printed Jun. 11, 2017 and Aug. 3, 2017, 3 pages.

Air Towel, White Touchless Hand Dryer Model # KTM-120, <https://mobileimages.lowes.com/product/converted/008529/00852905005013.jpg>, printed Jun. 11, 2017, 1 page.

ASI, Roval 20199 Recessed Automatic Hand Dryer, http://www.restroomdirect.com/images/products/detail/ASI_Roval_Profile_Recessed_Automatic_Satin_Stainless_Steel_Hand_Dryer_20199-93.jpg, <http://www.macdonaldindustries.co.nz/asi-roval-semi-recessed-high-speed-hand-dryer>, printed Jun. 11, 2017 and Aug. 3, 2017, 3 pages.

Palmer Fixture, BluStorm® Hand Dryer HD0955, http://www.palmerfixture.com/products/3_products_img/HD0955-09.jpg, printed Jun. 11, 2017, 3 pages.

Pinnacle, Touchless Hand Dryer Recessed Mount Model PDC-R10, http://www.pinnacleddryer.com/index.php?option=com_content&view=article&id=10&Itemid=111, printed Aug. 3, 2017, 2 pages.

Dihour®, ABS Plastic High Speed Hand Dryer DH2630T, <http://www.dihour.net/automatic-hand-dryer/dh2630t-brush.html>, printed Aug. 3, 2017, 2 pages.

Dolphin, BC2200SAR Recessed Hot Air Hand Dryer, http://www.c21hygiene.co.uk/403-thickbox_default/dolphin-bc2200sar-recessed-hot-air-hand-dryer.jpg, printed Jun. 11, 2017, 1 page.

Palmer Fixture, EcoStorm®, Hand Dryer HD0945, http://palmerfixture.com/products/3_products_img/HD0945-09.jpg, printed Jun. 11, 2017, 3 pages.

Air Fury®, R1 Recessed High-Speed Hand Dryer LR89ACS, http://www.air-fury.se/en/high_speed_recessed_hand_dryer_air_fury_r1.php, printed Aug. 3, 2017, 2 pages.

* cited by examiner

FIG. 1

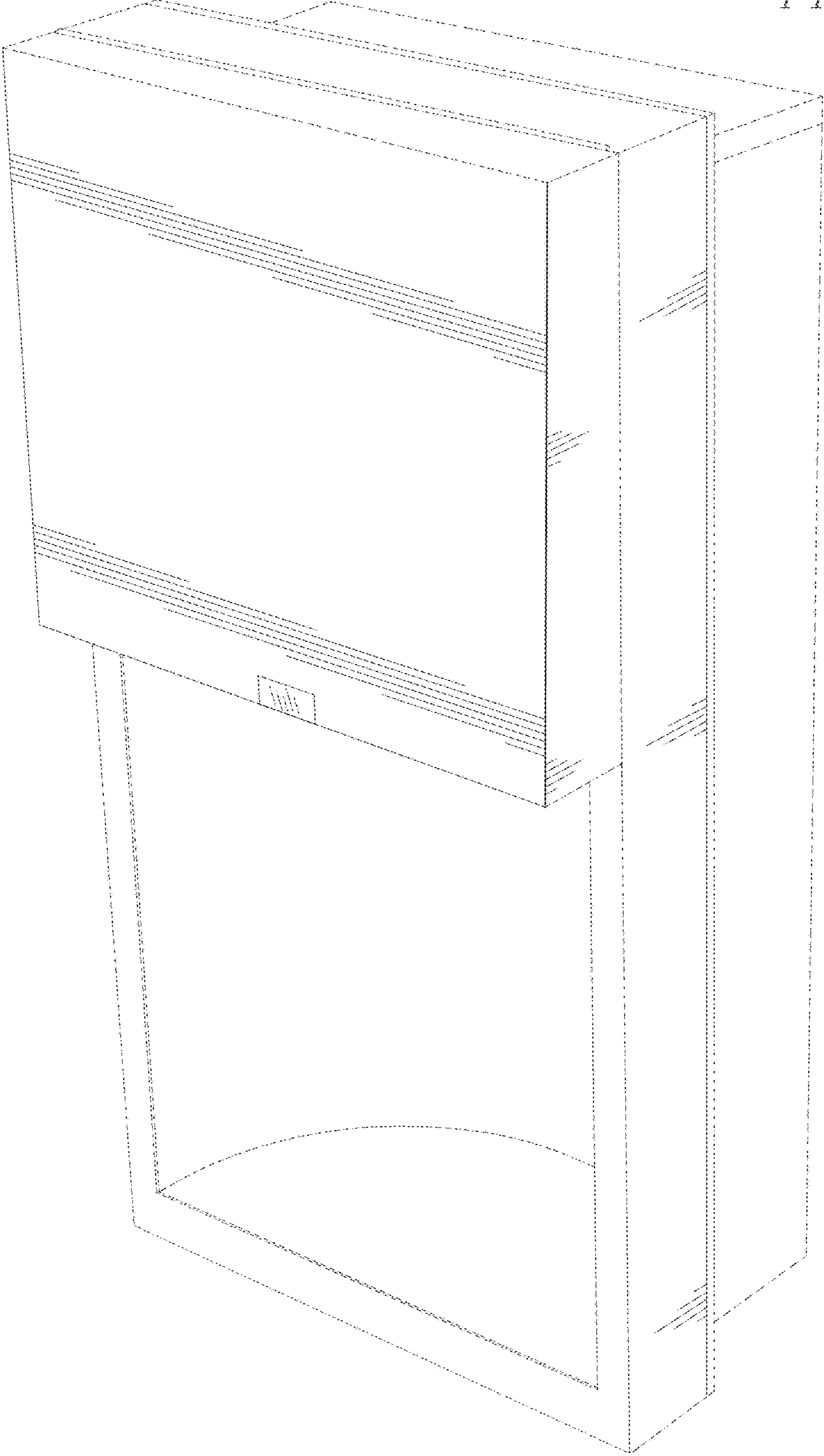

FIG. 2

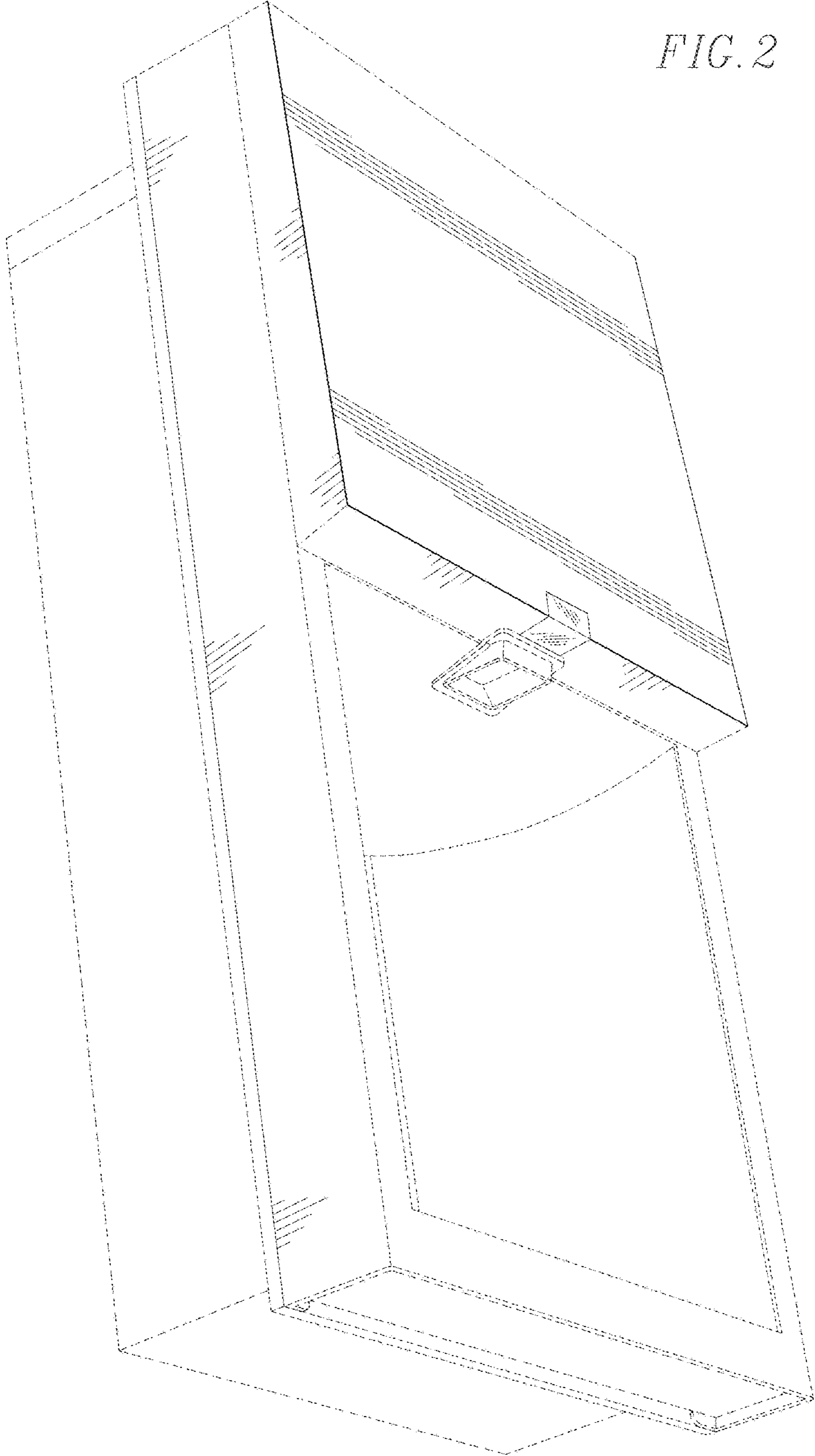

FIG. 3

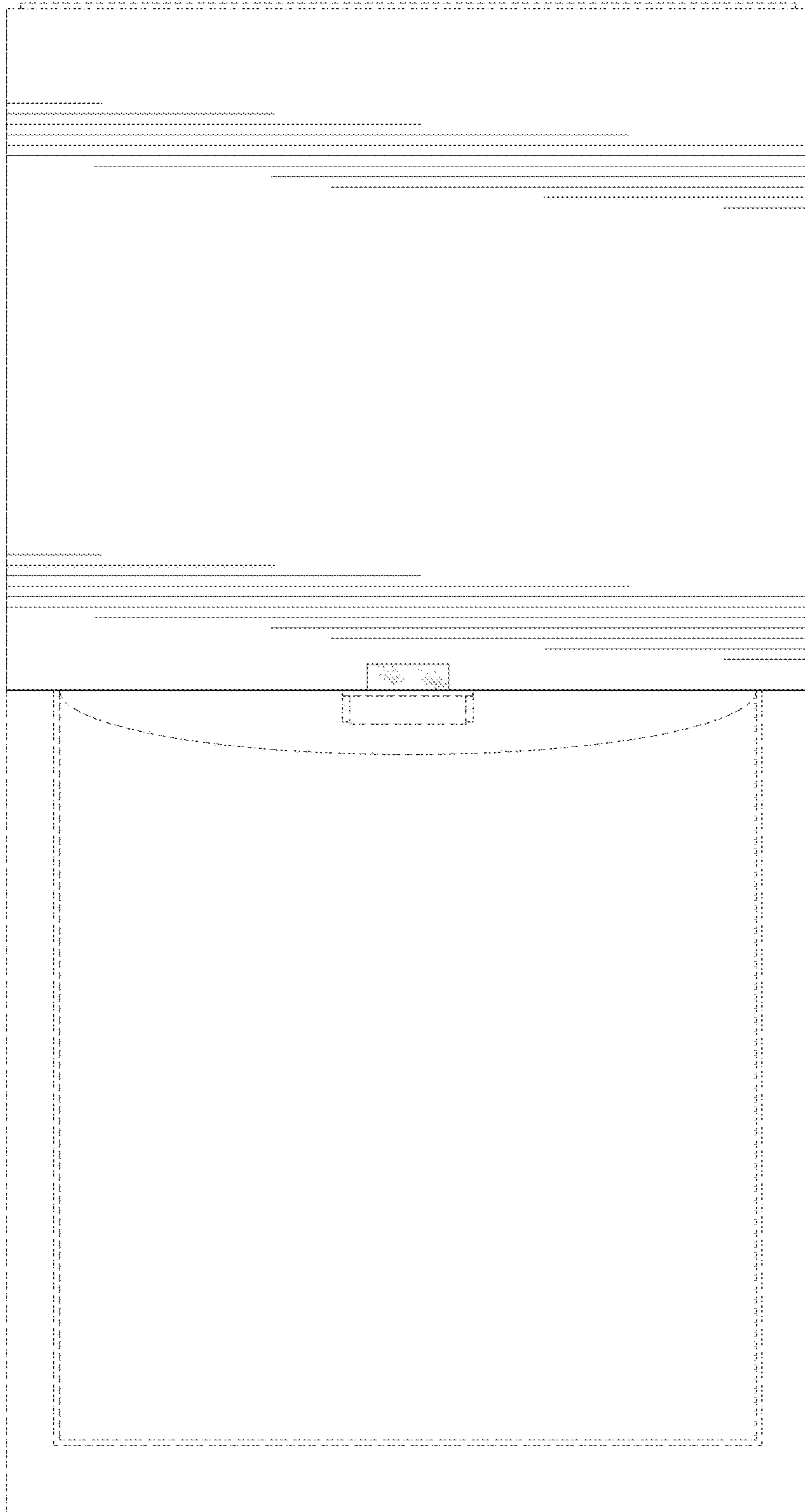

FIG. 4

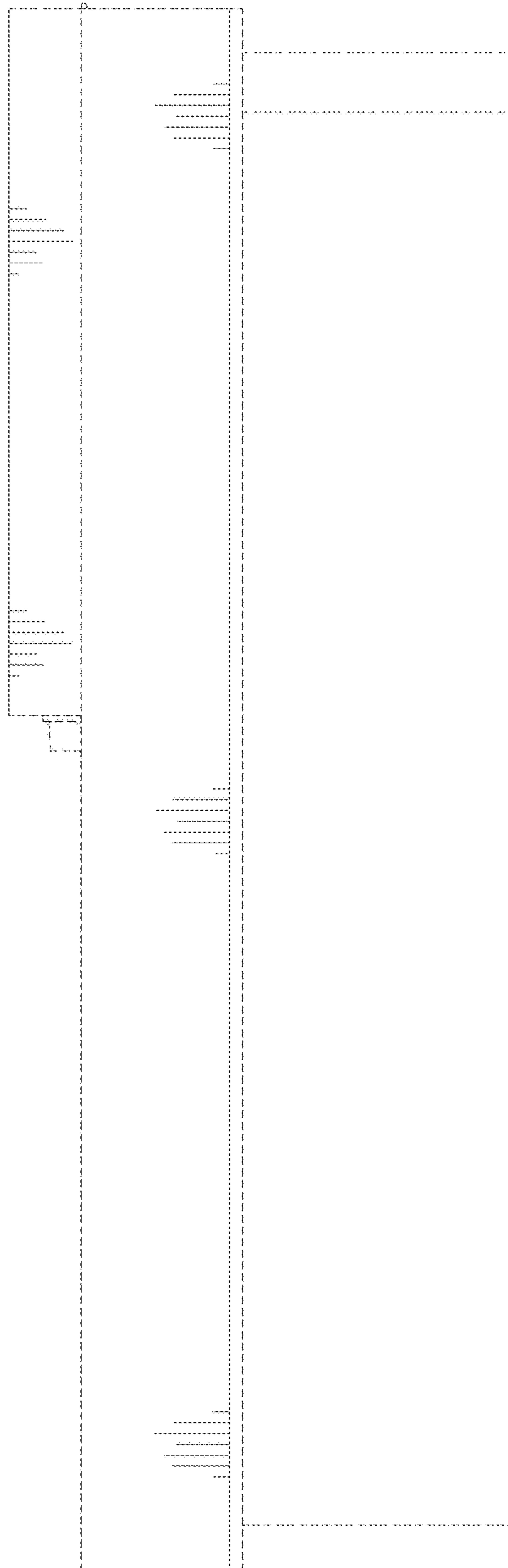

FIG. 5

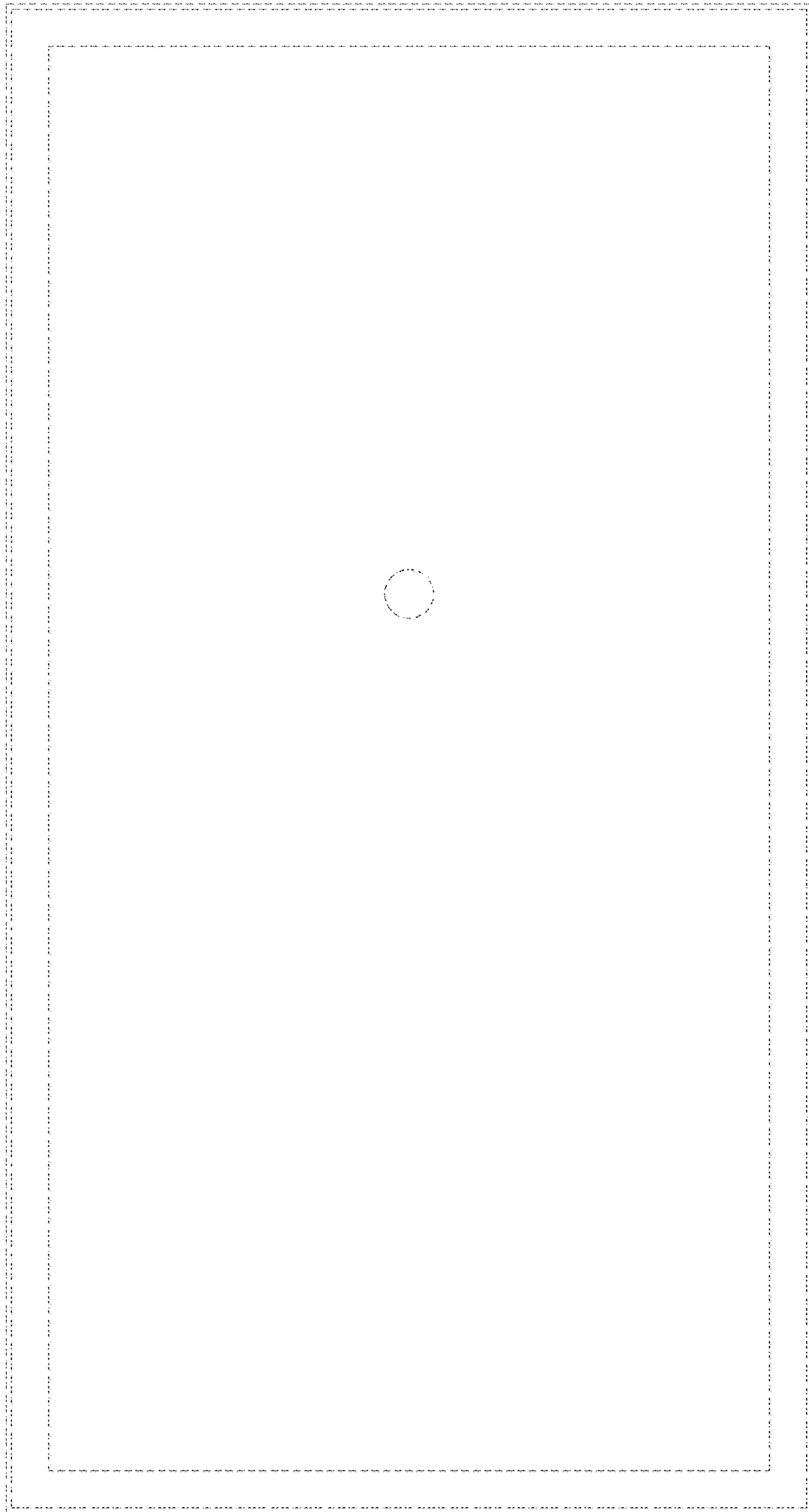
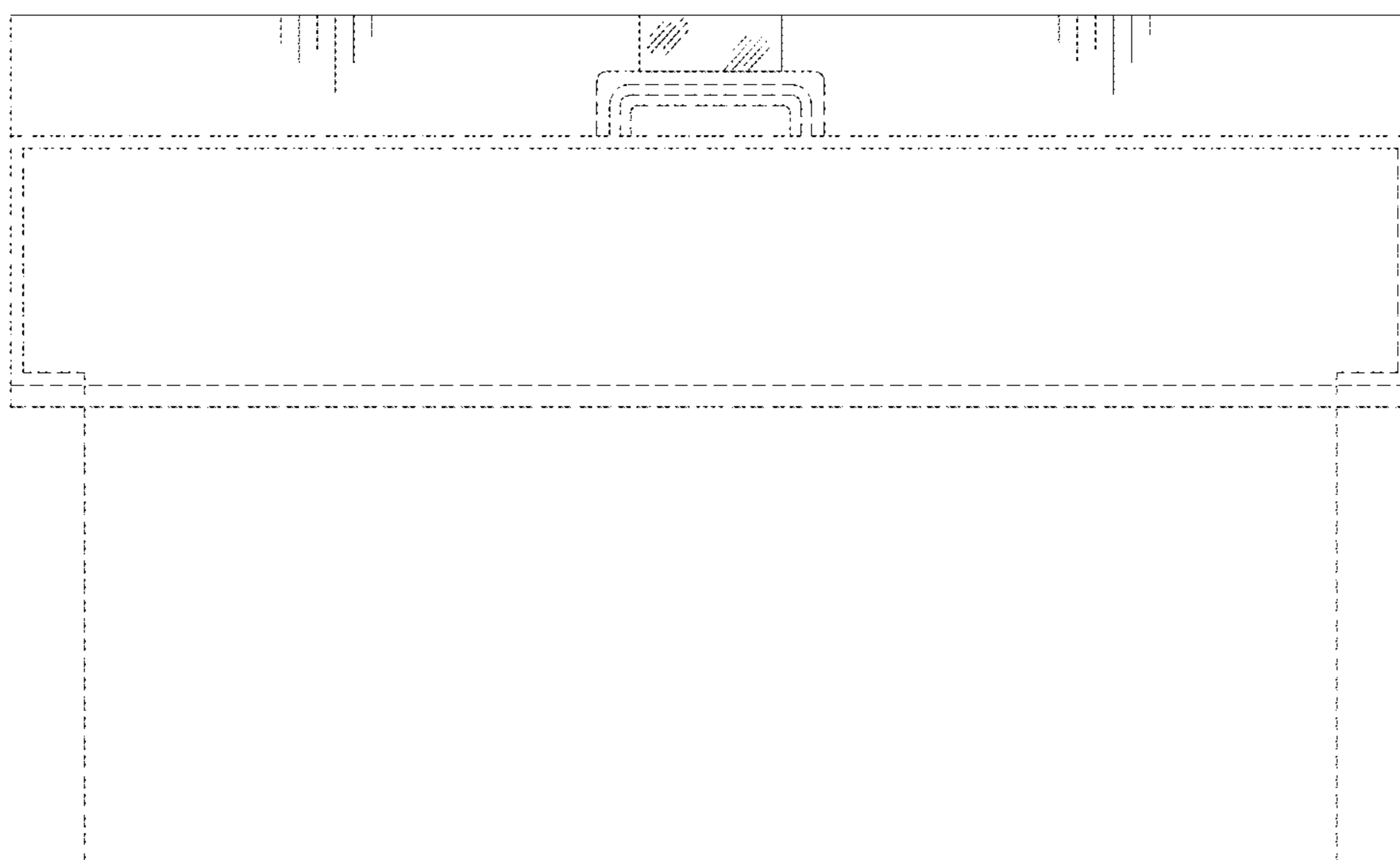

FIG. 6



FIG. 7



UNITED STATES PATENT AND TRADEMARK OFFICE
CERTIFICATE OF CORRECTION

PATENT NO. : D818,647 S
APPLICATION NO. : 29/526088
DATED : May 22, 2018
INVENTOR(S) : Dikran Babikian

Page 1 of 1

It is certified that error appears in the above-identified patent and that said Letters Patent is hereby corrected as shown below:

On the Title Page

Column 2, (57), description, Line 1	after “on”, delete “towel”
Page 2, Column 2, (56), other publications, Line 9	delete “%Dryer%”, insert -- %20Dryer%20 --
Page 2, Column 2, (56), other publications, Line 4	delete “dialqueenfrance”, insert -- disqueenfrance --
Page 2, Column 2, (56), other publications, Line 10	delete “jpg”, insert -- jpg, --
Page 2, Column 2, (56), other publications, Line 33	delete “hiqh”, insert -- high --

Signed and Sealed this
Thirteenth Day of August, 2019

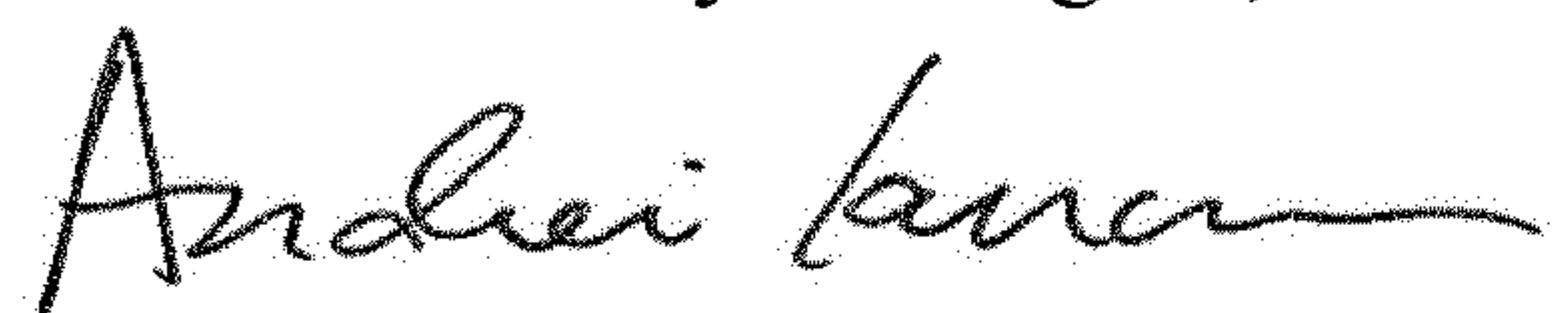

Andrei Iancu
Director of the United States Patent and Trademark Office