



US00D818536S

(12) **United States Design Patent** (10) **Patent No.:** **US D818,536 S**
Song (45) **Date of Patent:** **** May 22, 2018**

- (54) **GLUE PEN**
- (71) Applicant: **Huzhou Longlong Chemical Co., Ltd., Zhejiang (CN)**
- (72) Inventor: **Zhiguo Song, Zhejiang (CN)**
- (**) Term: **15 Years**
- (21) Appl. No.: **29/584,066**
- (22) Filed: **Nov. 11, 2016**
- (51) **LOC (11) Cl.** **19-99**
- (52) **U.S. Cl.**
USPC **D19/66**
- (58) **Field of Classification Search**
USPC D8/14, 29.1, 30, 51, 56, 61; D19/66;
D24/107, 133, 144
CPC B27G 11/00; B27G 11/005; B27G 11/02
See application file for complete search history.

- D616,937 S * 6/2010 Liu D19/165
- D631,477 S * 1/2011 Cacioppo D14/411
- D712,961 S * 9/2014 Jurcevic D19/66
- D740,630 S * 10/2015 Hasenmayer D8/30
- D787,907 S * 5/2017 Exley D8/30

* cited by examiner

Primary Examiner — Daniel D Bui
Assistant Examiner — Andrew Kerr

(74) *Attorney, Agent, or Firm* — Prakash Nama; Global IP Services, PLLC

(57) **CLAIM**

The ornamental design for a glue pen, as shown and described.

DESCRIPTION

FIG. 1 is a front elevational view of a glue pen showing my new design;
FIG. 2 is a rear elevational view thereof;
FIG. 3 is a left side view thereof;
FIG. 4 is a right side view thereof;
FIG. 5 is a top plan view thereof shown in enlarged scale;
FIG. 6 is a bottom plan view thereof shown in enlarged scale; and,
FIG. 7 is a perspective view thereof.
The broken lines shown form no part of the claimed design.

(56) **References Cited**

U.S. PATENT DOCUMENTS

- D463,495 S * 9/2002 Sasada D19/66
- 7,329,062 B2 * 2/2008 Brand B43K 8/022
401/107
- D584,355 S * 1/2009 Hidaka D14/411

1 Claim, 6 Drawing Sheets

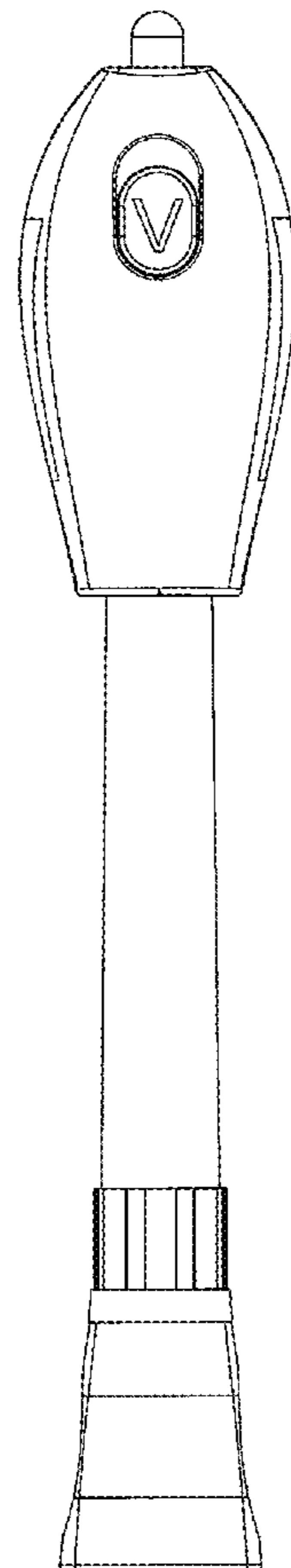

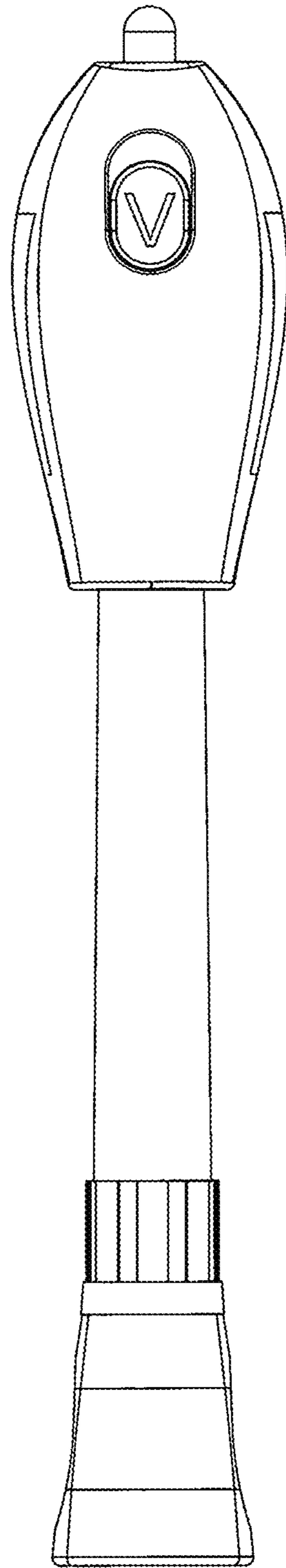

FIG. 1

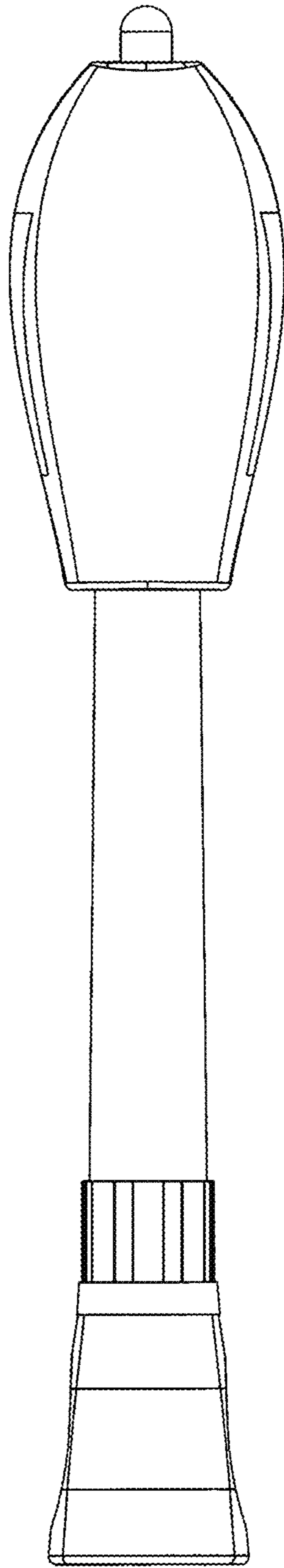

FIG. 2

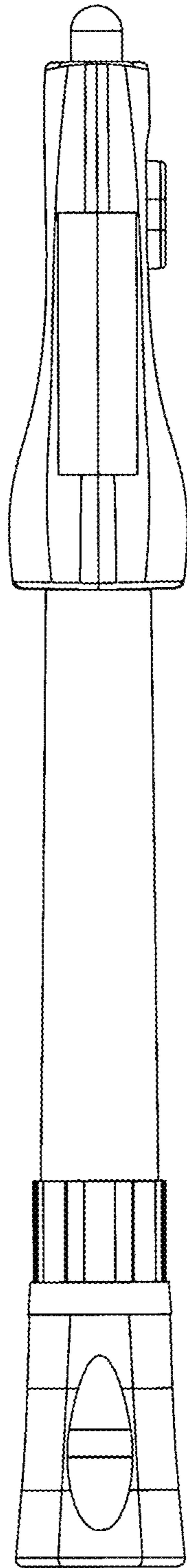

FIG. 3

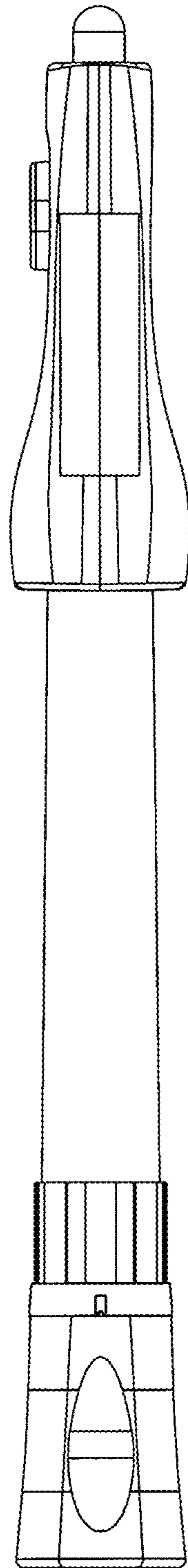

FIG. 4

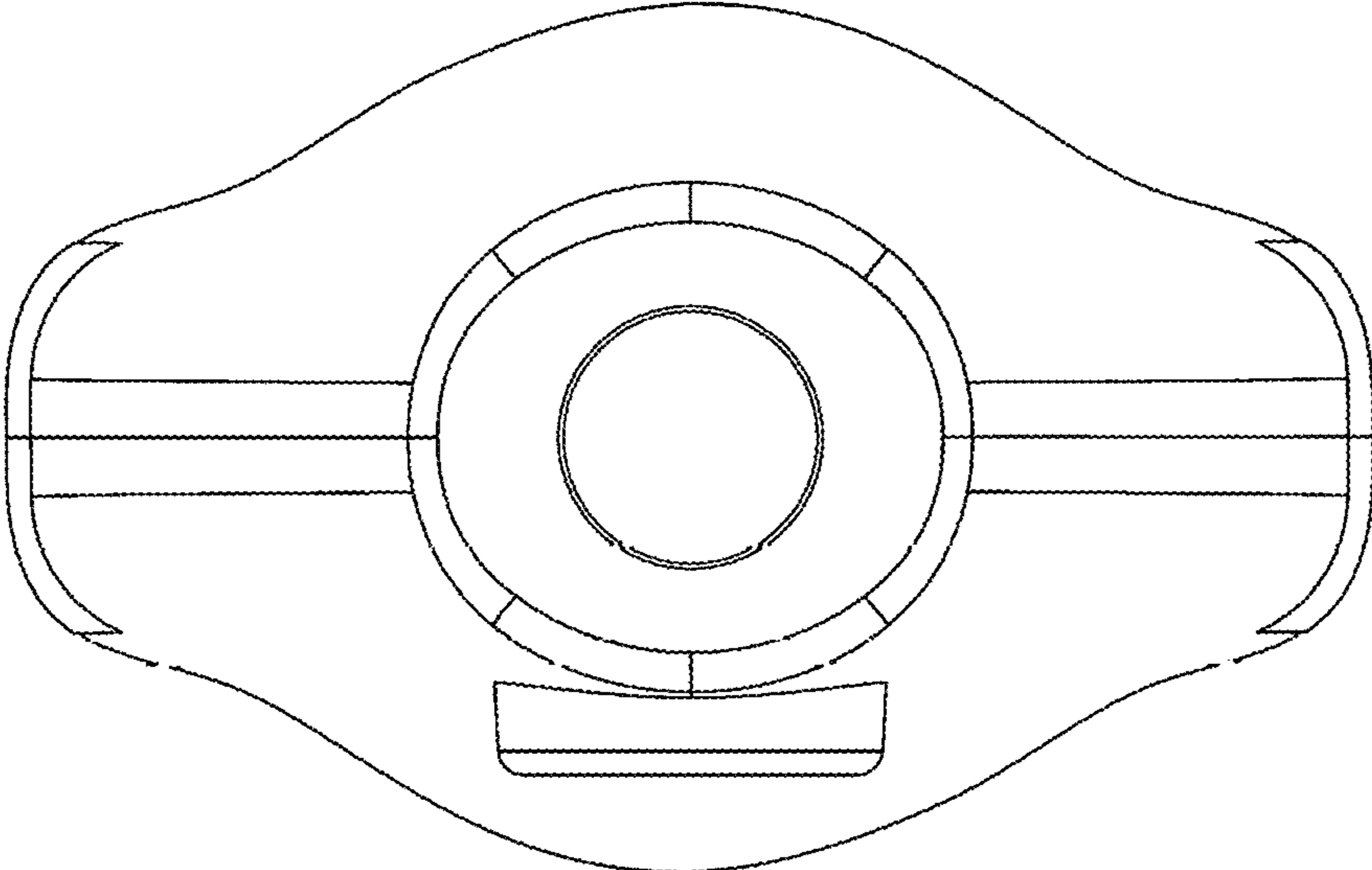

FIG. 5

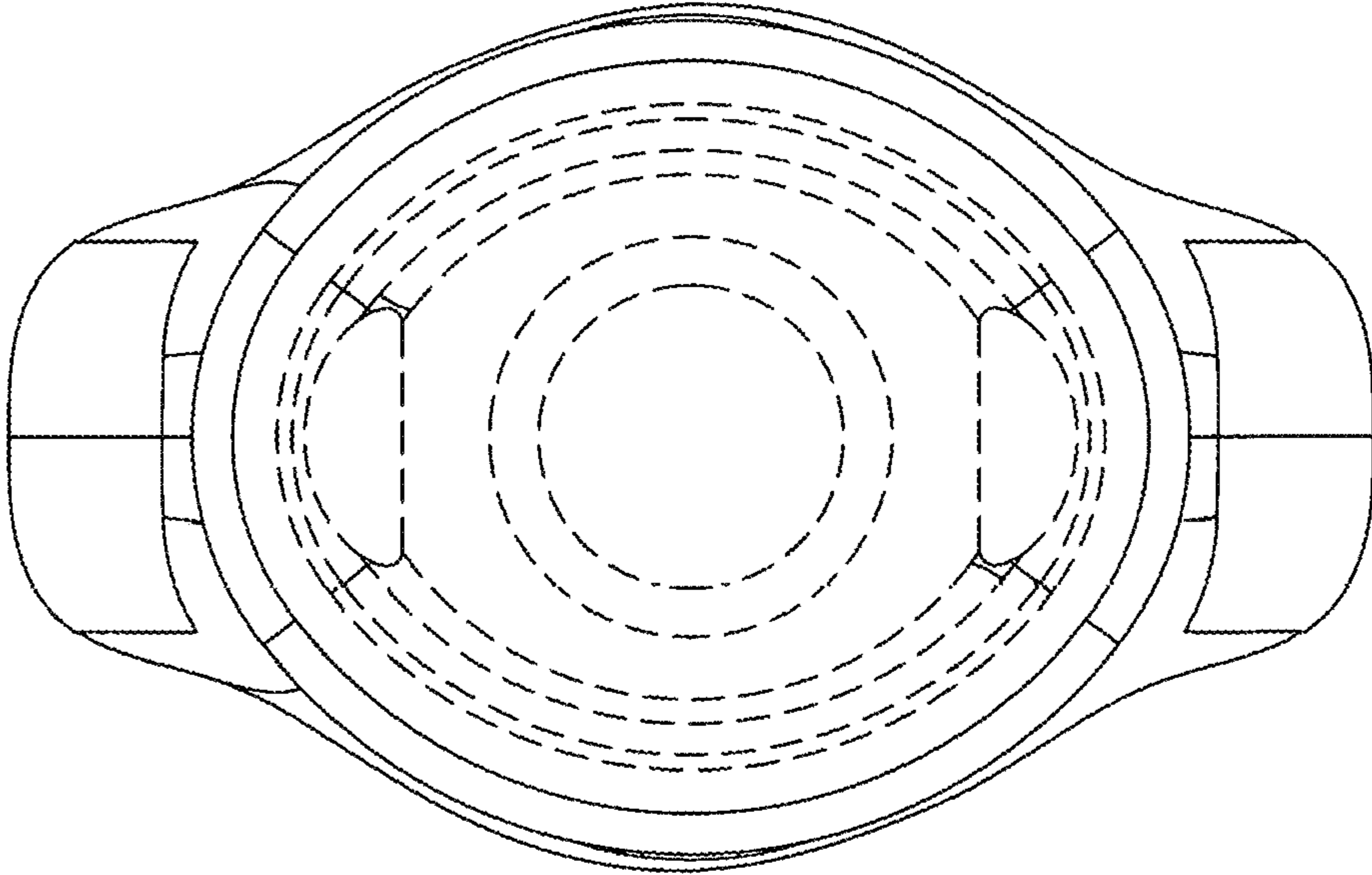

FIG. 6

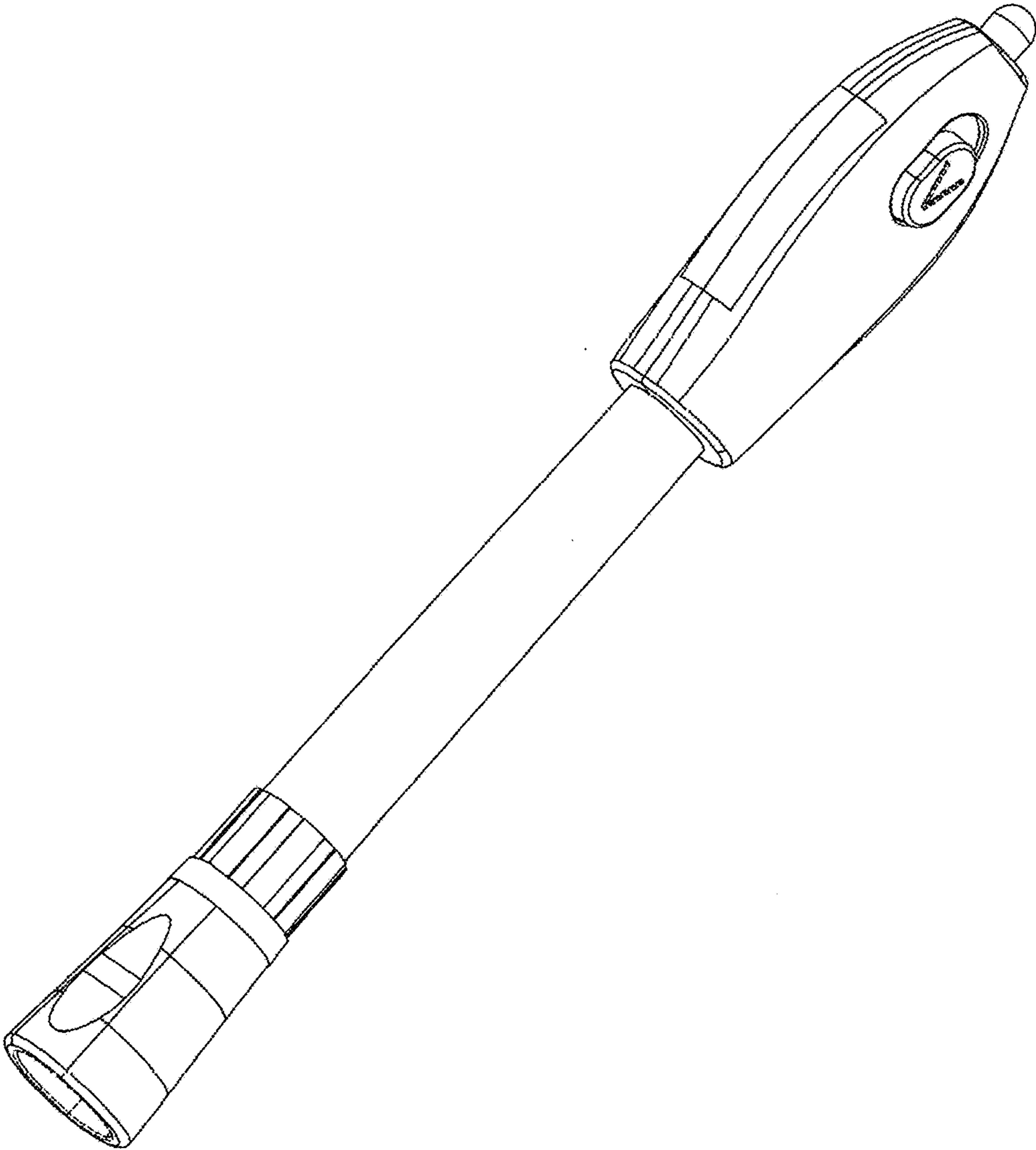

FIG. 7