



US00D818394S

(12) **United States Design Patent**
Hung et al.

(10) **Patent No.: US D818,394 S**

(45) **Date of Patent: ** May 22, 2018**

(54) **ZIPPER TOOTH**

FOREIGN PATENT DOCUMENTS

(71) Applicant: **IDEAL FASTENER (GUANGDONG) INDUSTRIES LTD.**, Guangdong (CN)

CN 106165946 A * 11/2016 A44B 19/24

(72) Inventors: **Franklin Chi Yen Hung**, Guangdong (CN); **Gollen Qiu**, Guangdong (CN); **William Qiu**, Guangdong (CN); **Wenqi Zhang**, Guangdong (CN); **Ali Lv**, Guangdong (CN); **Andy Zeng**, Guangdong (CN); **Fukang Wu**, Guangdong (CN)

OTHER PUBLICATIONS

YKK Zipper Chain—Vision (Molded Tooth)—Black—Size 10, VaughBros.com, [online], [site visited Sep. 12, 2017]. <URL: <http://www.vaughanbros.com/product/Z-10-YKK-MT-BLA.html>>.*

(Continued)

(**) Term: **15 Years**

Primary Examiner — T. Chase Nelson

Assistant Examiner — Jonathan J. Han

(21) Appl. No.: **29/589,182**

(74) *Attorney, Agent, or Firm* — Prakash Nama; Global IP Services, PLLC

(22) Filed: **Dec. 29, 2016**

(30) **Foreign Application Priority Data**

(57) **CLAIM**

Jun. 30, 2016 (CN) 2016 3 0295588

The ornamental design for a zipper tooth, as shown and described.

(51) **LOC (11) Cl.** **02-07**

(52) **U.S. Cl.**
USPC **D11/221**

DESCRIPTION

(58) **Field of Classification Search**
USPC D11/200–201, 221, 86, 87; 24/358–387, 24/414–417, 421–433, 4, 412; 2/265; D2/641, 642; 294/2, 3.6; 223/111
CPC A44B 19/00; A44B 19/02; A44B 19/04; A44B 19/10; A44B 19/24; A44B 19/26; A44B 19/30
See application file for complete search history.

FIG. 1 is a front elevational view of a zipper tooth showing our new design;
FIG. 2 is a rear elevational view thereof;
FIG. 3 is a left side view thereof;
FIG. 4 is a right side view thereof;
FIG. 5 is a bottom plan view thereof;
FIG. 6 is a top plan view thereof;
FIG. 7 is a perspective view thereof;
FIG. 8 is a second perspective view thereof;
FIG. 9 is a third perspective view thereof; and,
FIG. 10 is a reduced-scale perspective view showing the zipper tooth in a condition of use with other unclaimed zipper teeth and additional environmental structure assembled together forming a slide fastener. The broken lines shown in FIG. 10 are used to show unclaimed environment and form no part of the claimed design.

(56) **References Cited**

U.S. PATENT DOCUMENTS

4,004,327 A * 1/1977 Fukuroi A44B 19/04
24/411
4,040,150 A * 8/1977 Fukuroi A44B 19/06
24/410
4,062,100 A * 12/1977 Heimberger A44B 19/58
29/408
D252,896 S * 9/1979 Jovin 24/410

(Continued)

1 Claim, 10 Drawing Sheets

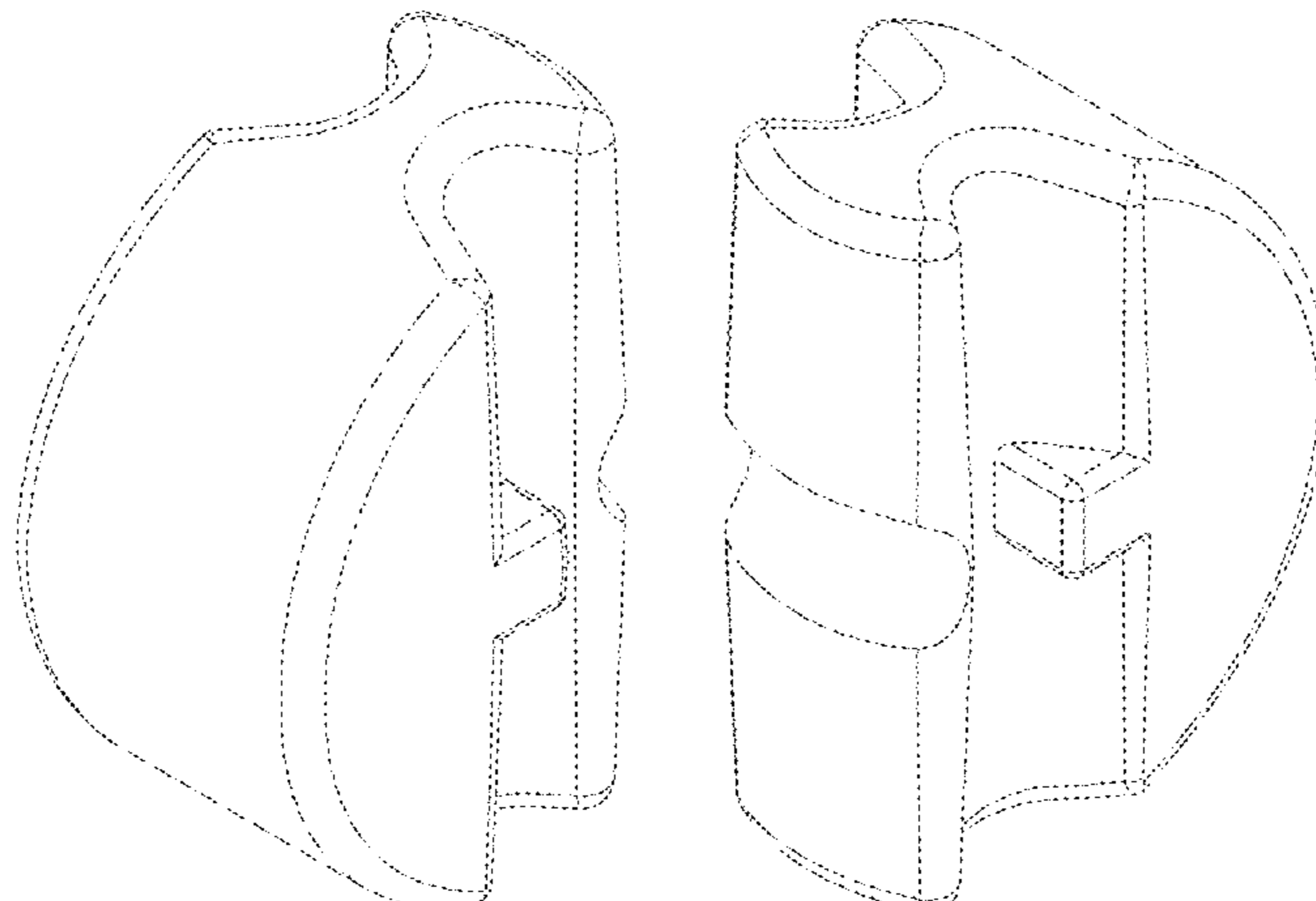

(56)

References Cited

U.S. PATENT DOCUMENTS

4,458,391 A * 7/1984 Scarpini A44B 19/346
24/403
4,502,190 A * 3/1985 Inamura A44B 19/32
24/389
4,520,535 A * 6/1985 Kasai A44B 19/06
24/410
4,922,585 A * 5/1990 Suzuki A44B 19/34
24/381
5,007,145 A * 4/1991 Kim A44B 19/38
24/388
6,421,887 B1 * 7/2002 Oda A44B 19/38
24/433
D724,996 S * 3/2015 Hung D11/221
2003/0213106 A1 * 11/2003 Ichikawa A44B 19/388
24/433
2004/0205942 A1 * 10/2004 Tsauro A44B 19/388
24/433
2005/0060848 A1 * 3/2005 Tsauro A44B 19/36
24/436
2006/0218758 A1 * 10/2006 Chang A44B 19/262
24/431
2007/0124900 A1 * 6/2007 Himi A44B 19/08
24/403
2007/0209170 A1 * 9/2007 Davies A44B 19/32
24/403
2008/0007940 A1 * 1/2008 Cheng A44B 19/00
362/103
2008/0052880 A1 * 3/2008 Sullivan A44B 19/30
24/418

2008/0196219 A1 * 8/2008 Holloway A44B 19/36
24/436
2009/0019675 A1 * 1/2009 Peano A44B 19/26
24/389
2009/0320250 A1 * 12/2009 Yamamoto A44B 19/32
24/389
2010/0306970 A1 * 12/2010 Tsao A44B 19/06
24/406
2011/0265291 A1 * 11/2011 Kojima A44B 19/00
24/406
2012/0311828 A1 * 12/2012 Nir A44B 19/04
24/389
2013/0139365 A1 * 6/2013 Sato A44B 19/28
24/429
2015/0151499 A1 * 6/2015 Yamakita A44B 19/42
24/403
2015/0173462 A1 * 6/2015 Takani A44B 19/06
24/412
2015/0343681 A1 * 12/2015 Mizumoto A44B 19/06
24/381
2016/0324273 A1 * 11/2016 Hahizume A44B 19/08
2017/0079385 A1 * 3/2017 Mizumoto A44B 19/26
2017/0127771 A1 * 5/2017 Sato A44B 19/285

OTHER PUBLICATIONS

Plastic Zippers, OlympicZipper.com, [online], [site visited Sep. 12, 2017]. <URL: <http://www.olympiczipper.com/plastic-zippers-olympic-zippers-limited.html>>.*
Plastic Zipper Long Chain, Germes-Online.com, [online], [site visited Sep. 12, 2017]. <URL: http://www.germes-online.com/catalog/69/75/243/330428/plastic_zipper_long_chain.html>.*

* cited by examiner

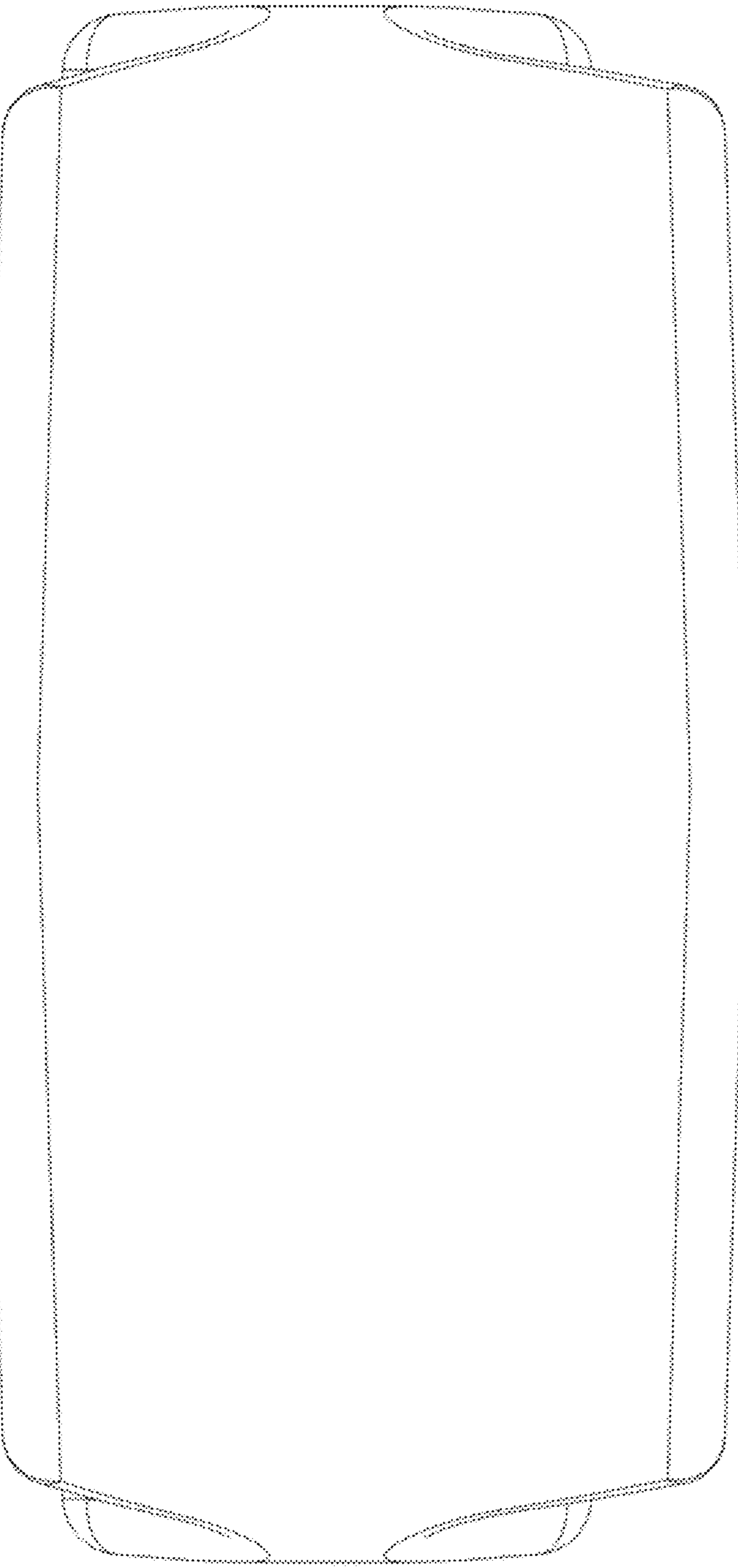

FIG. 1

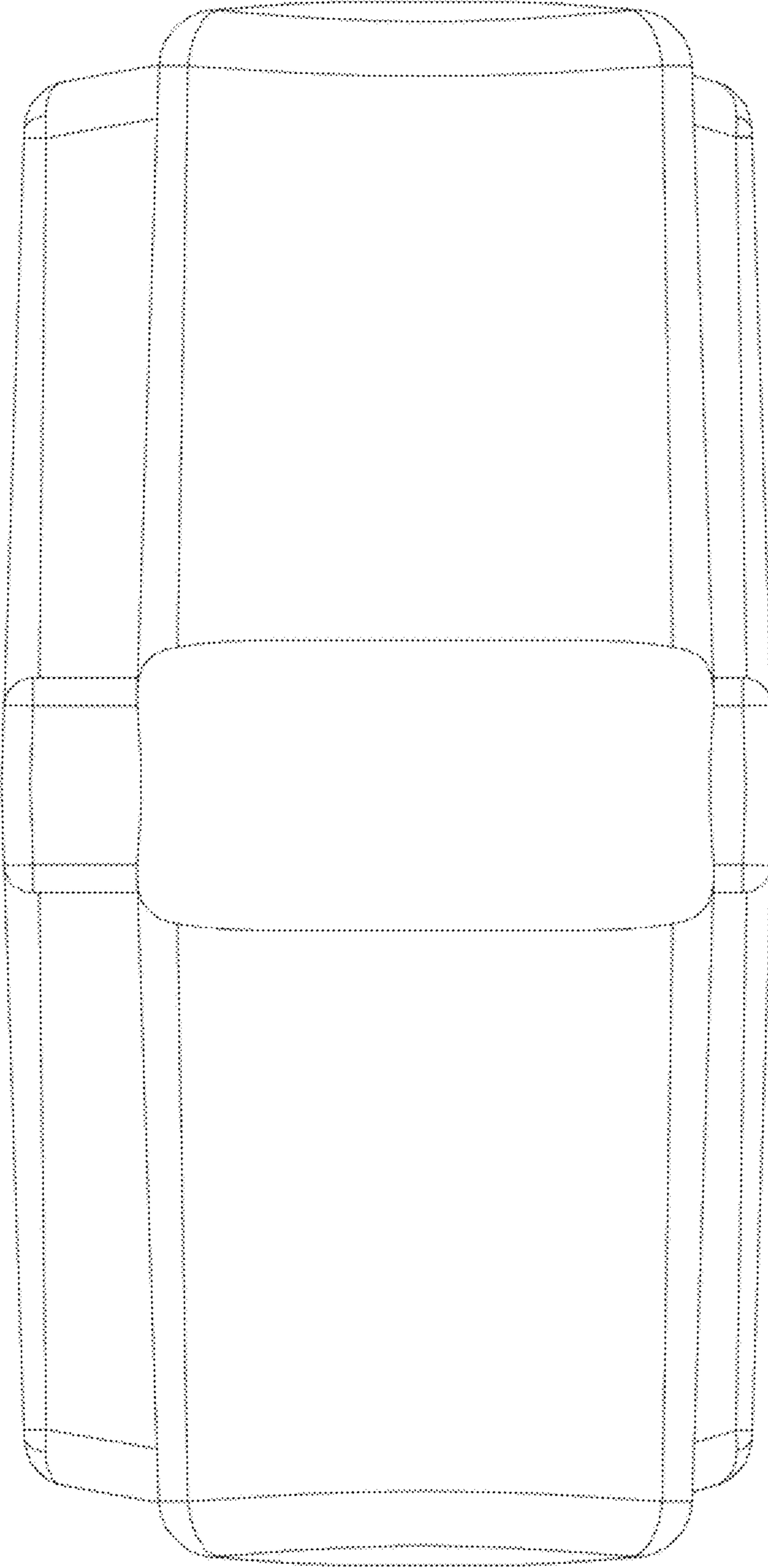

FIG. 2

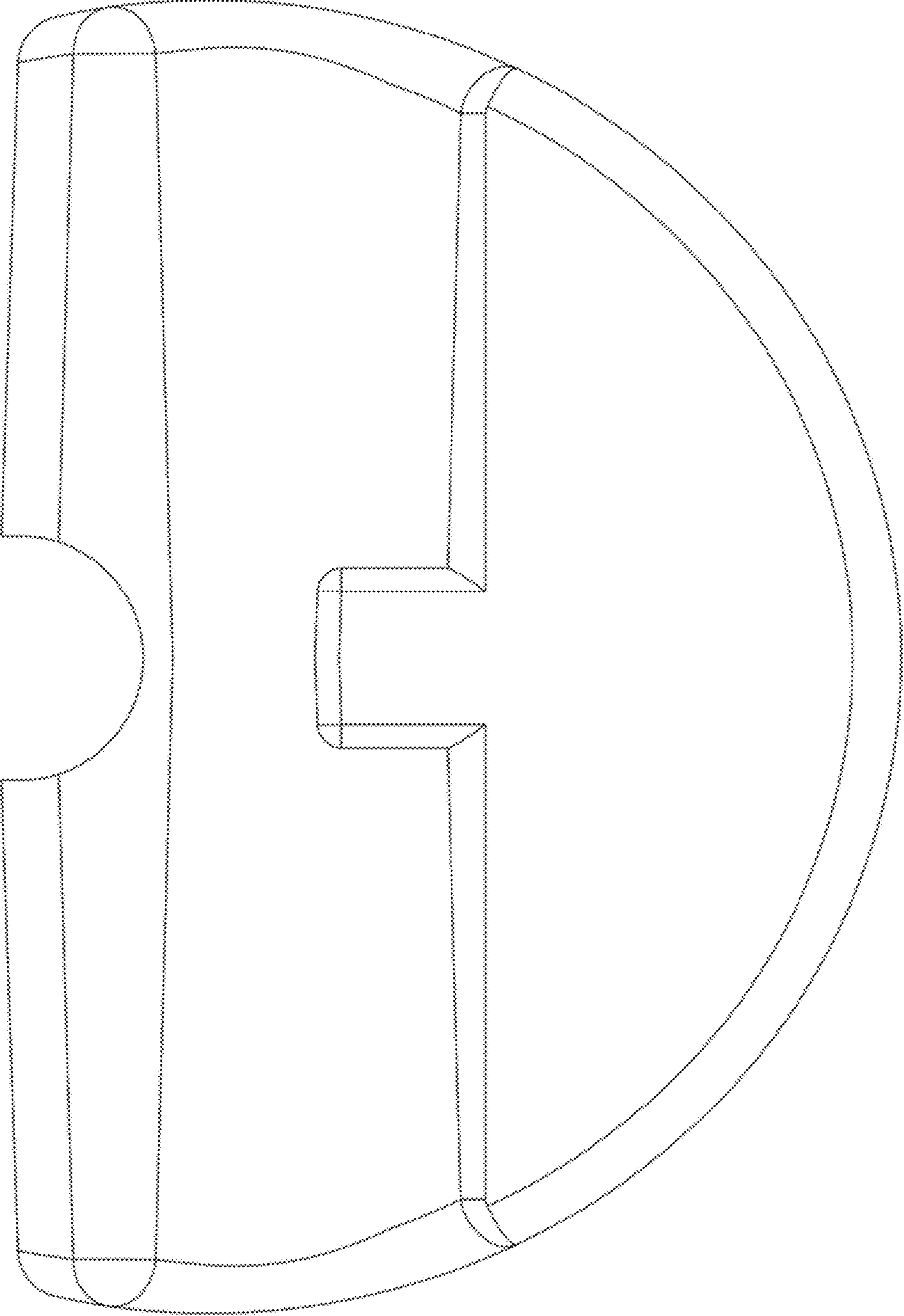

FIG. 3

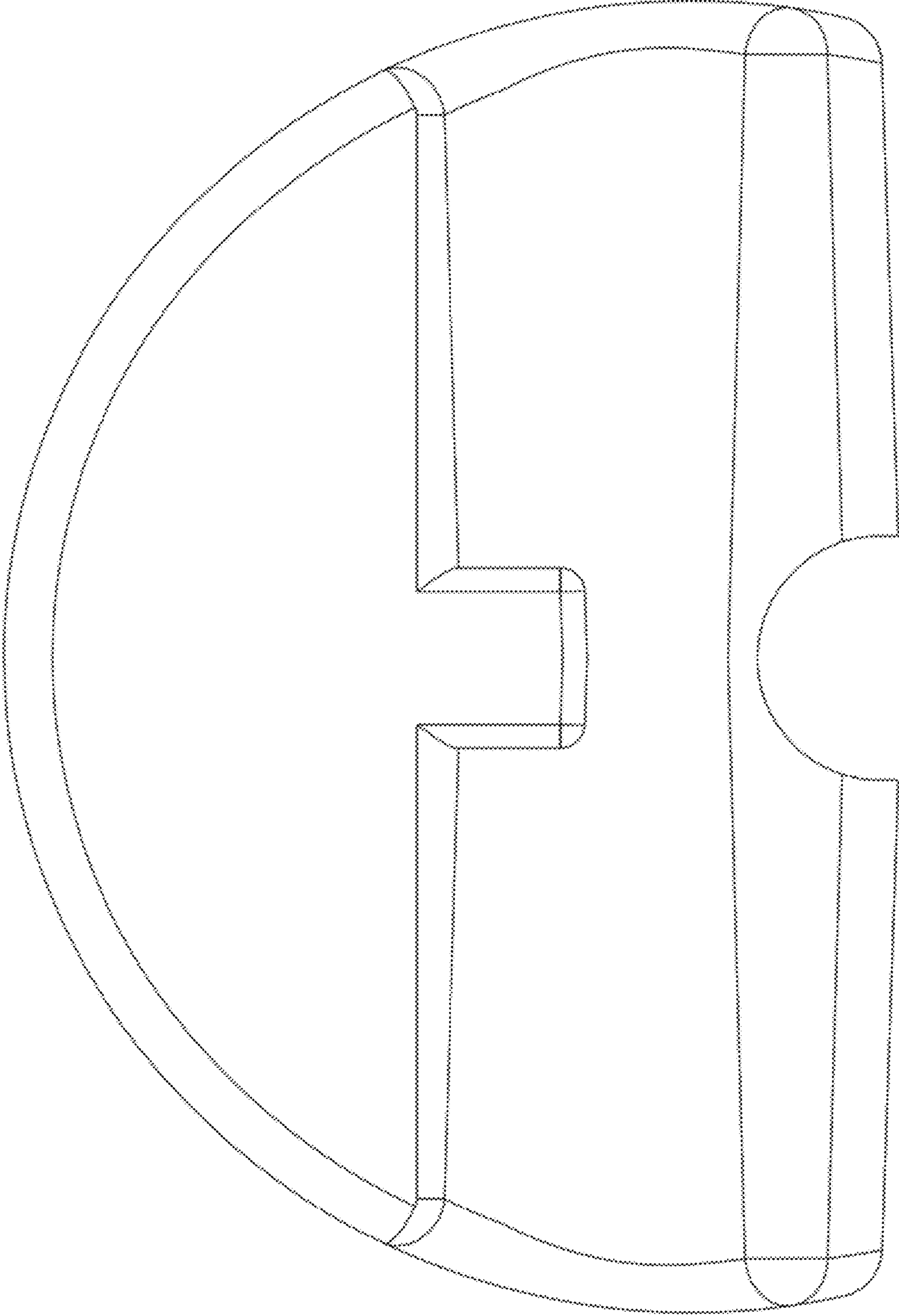

FIG. 4

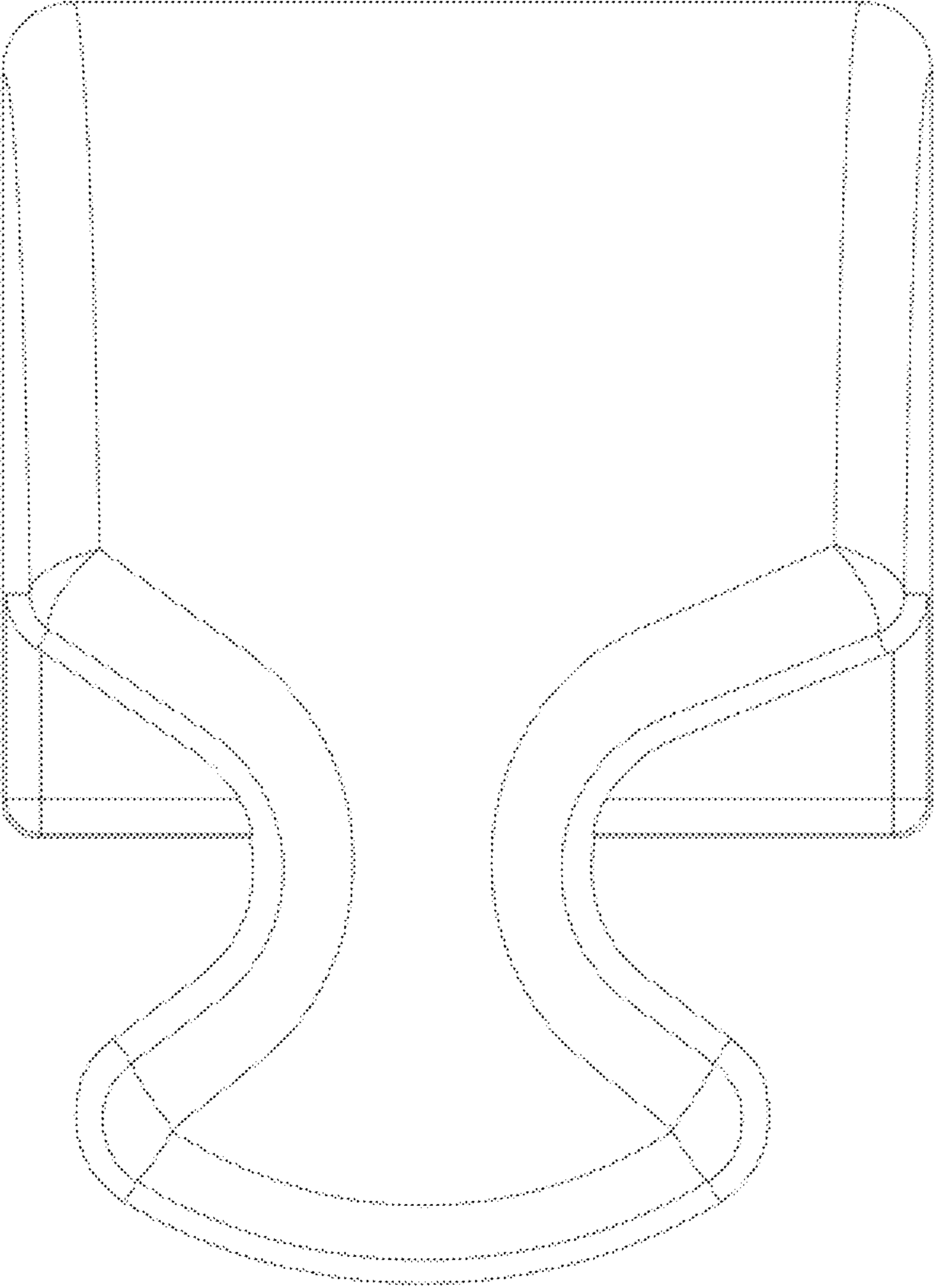

FIG. 5

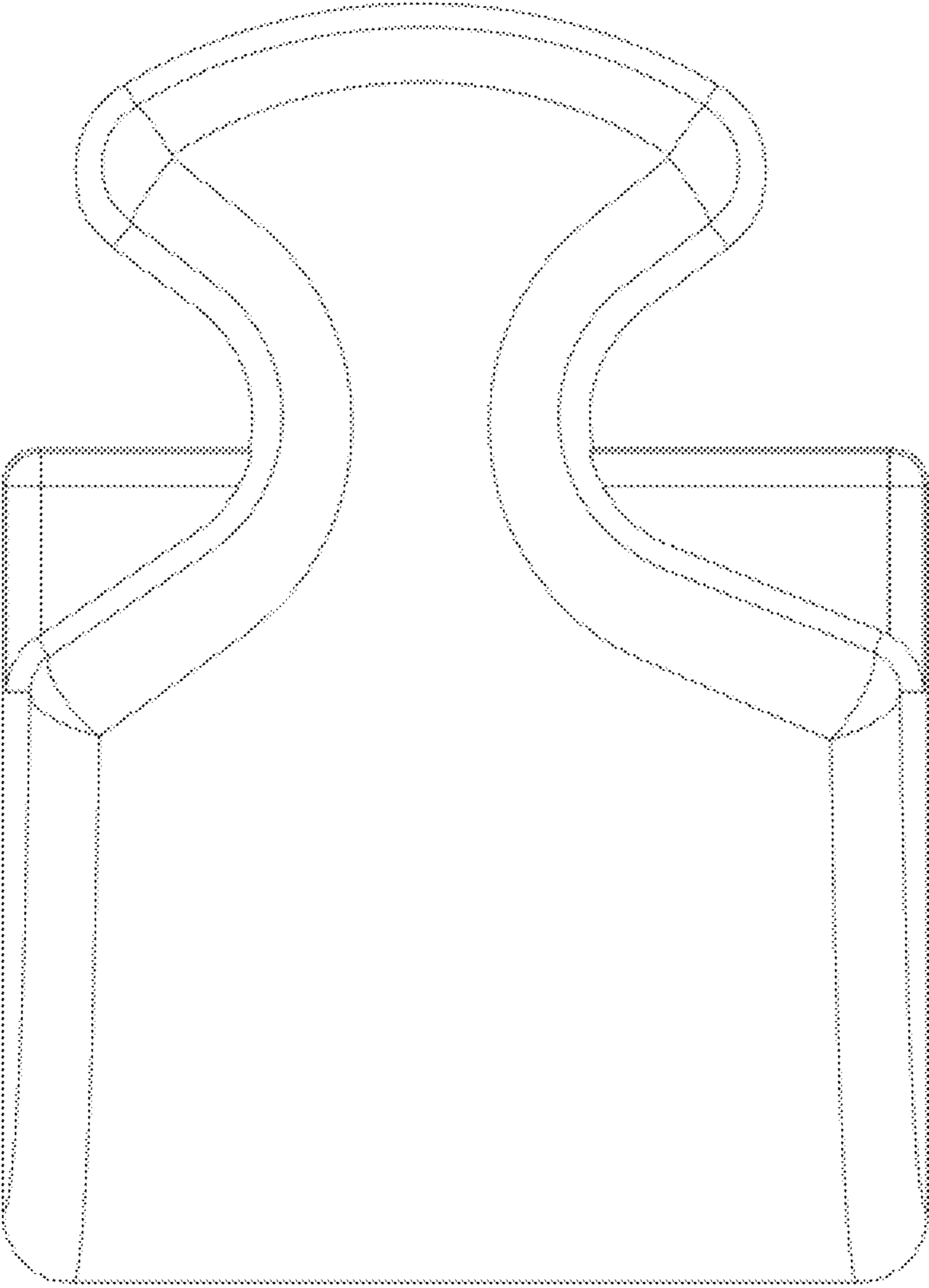

FIG. 6

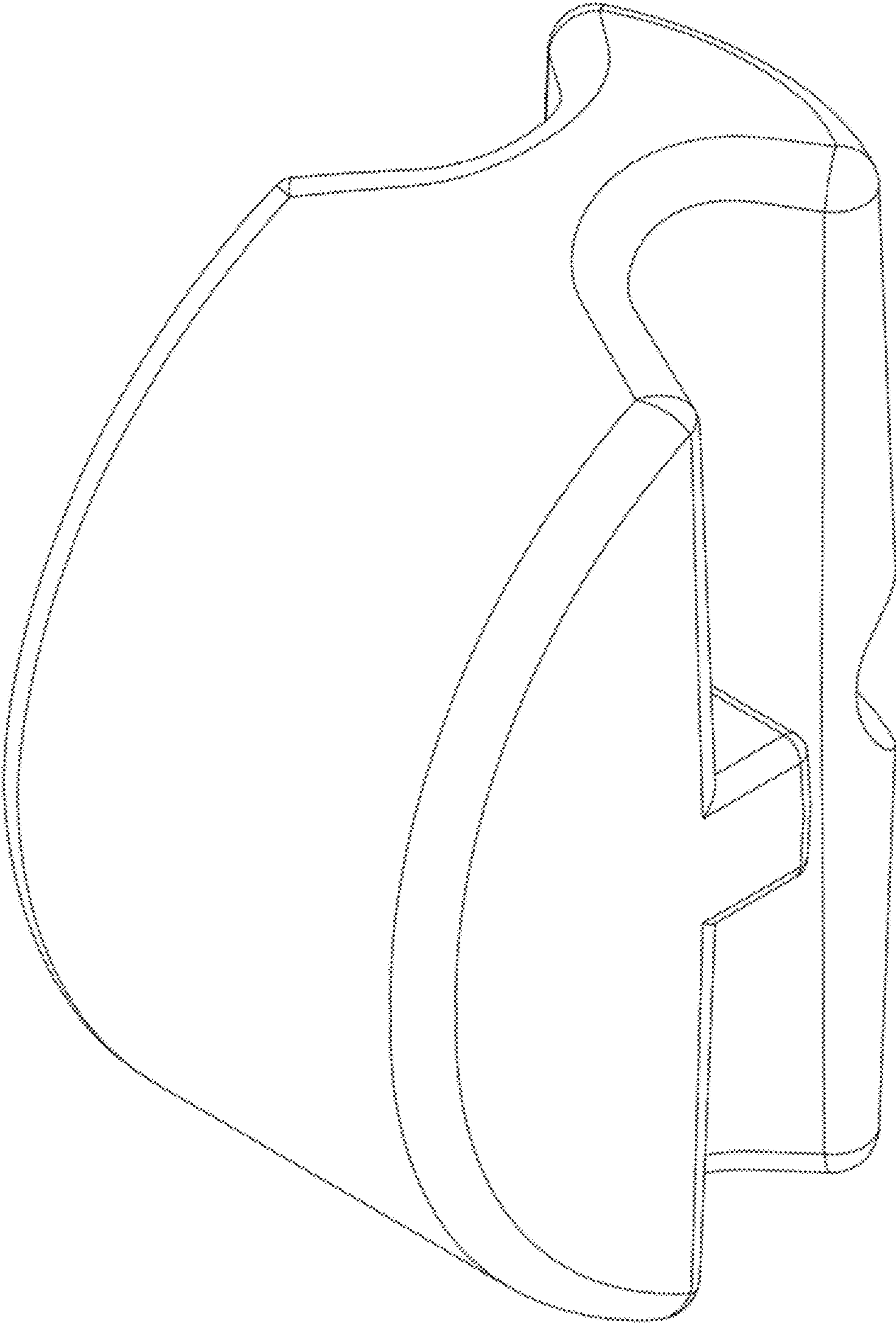

FIG. 7

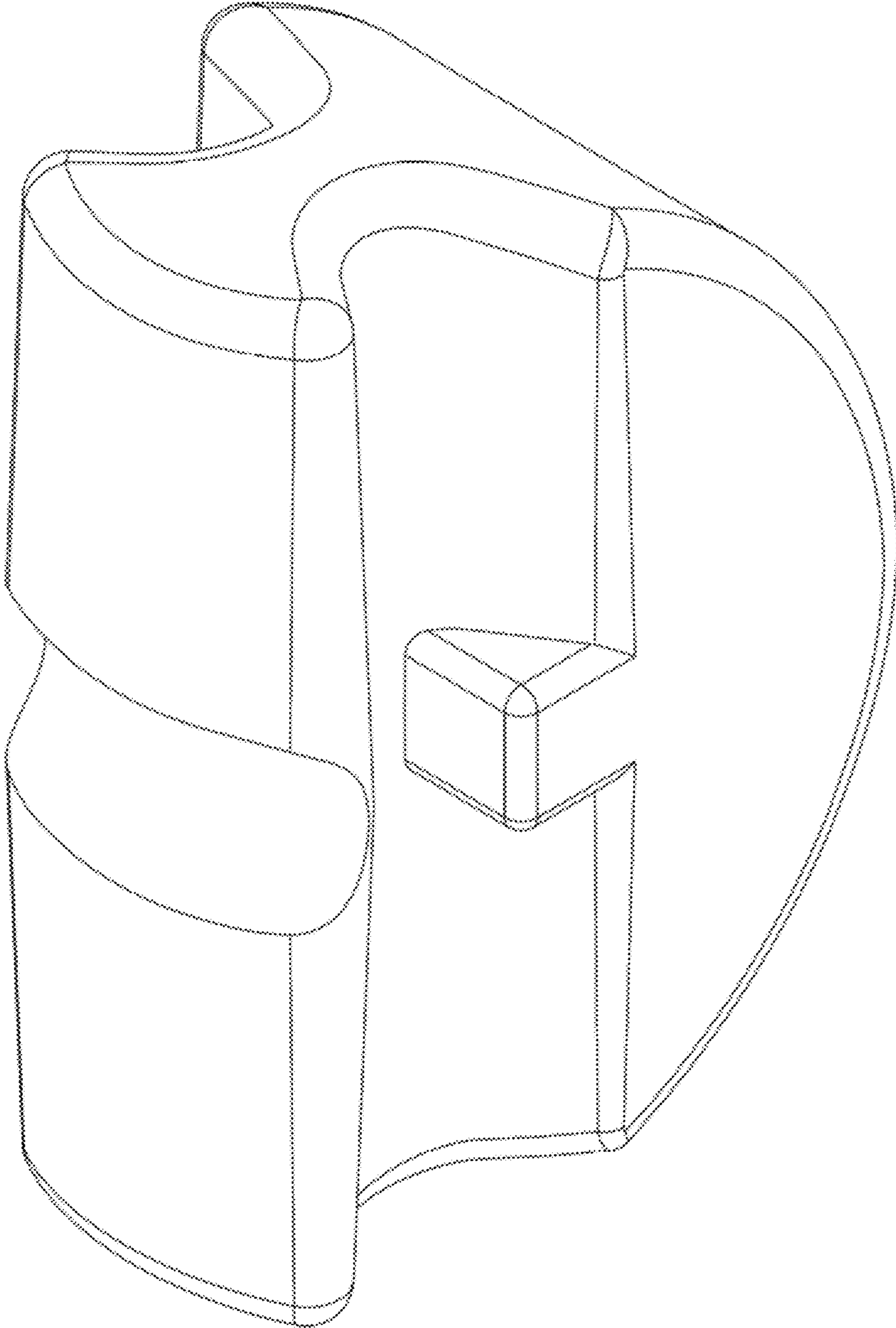

FIG. 8

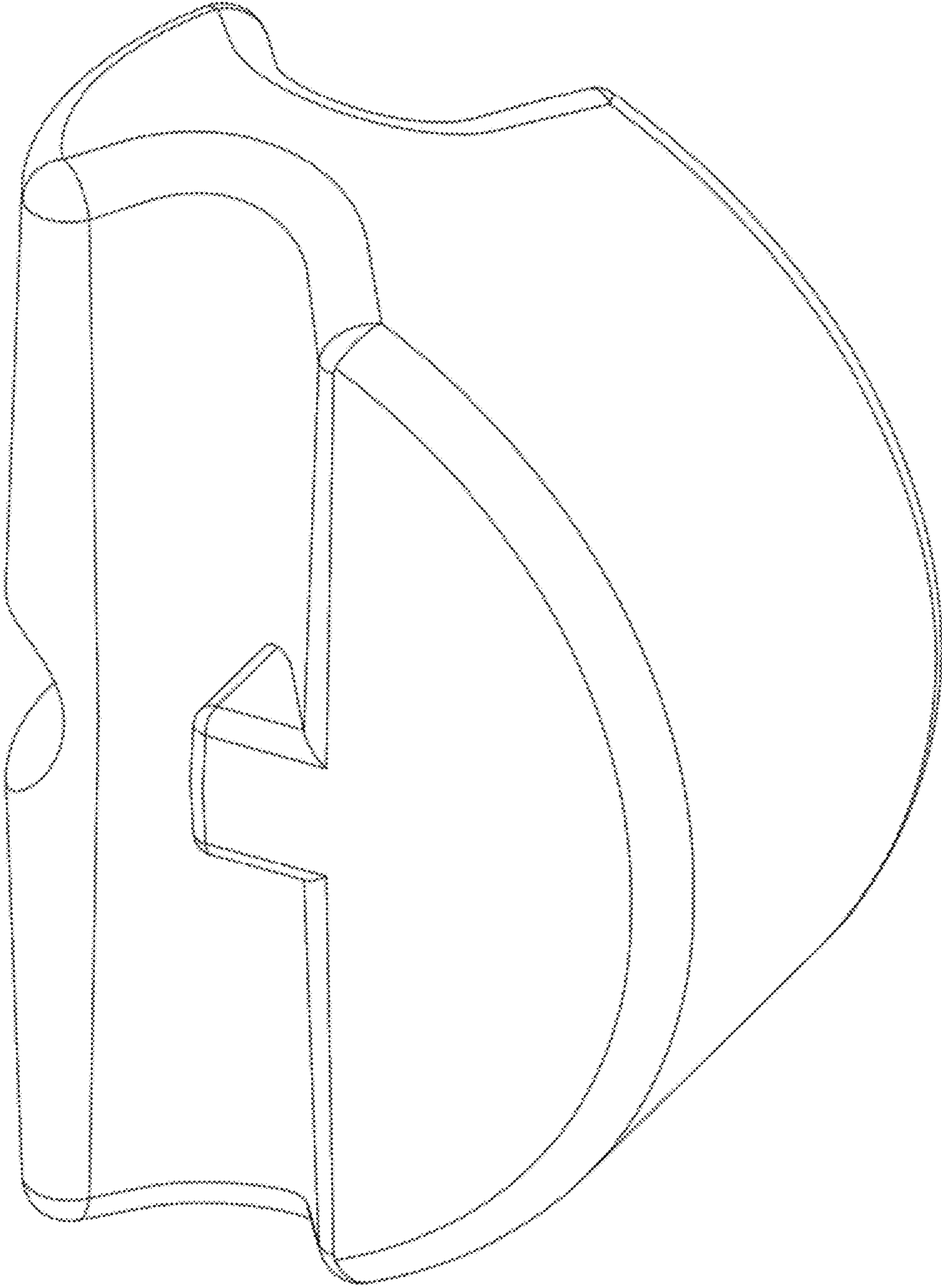

FIG. 9

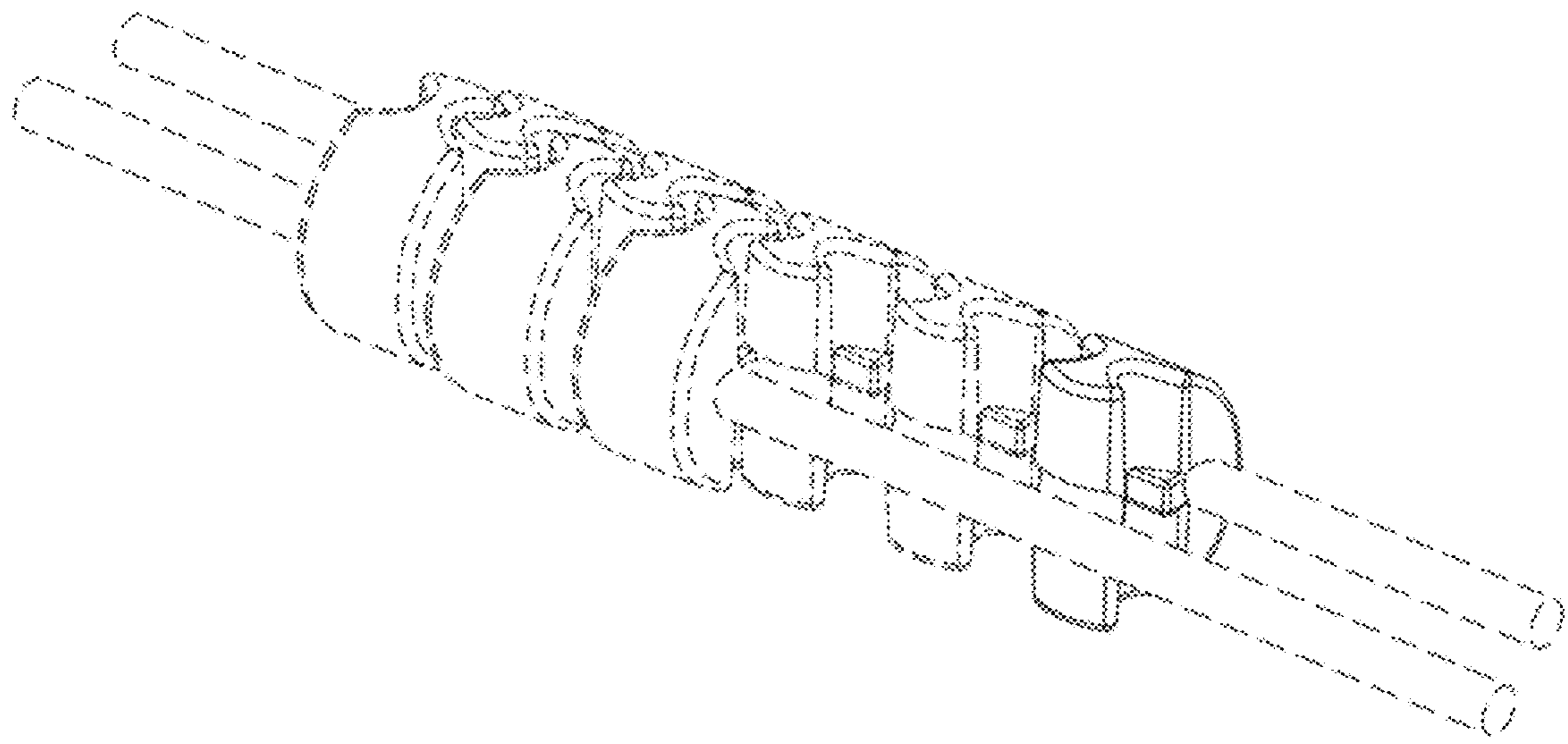

FIG. 10