



US00D818368S

(12) **United States Design Patent** (10) **Patent No.:** **US D818,368 S**
Hanan et al. (45) **Date of Patent:** **** May 22, 2018**

- (54) **PLASTIC UTILITY BOTTLE WITH NARROW NECK**
- (71) Applicants: **Jay Clarke Hanan**, Ontario, CA (US);
Zachary Curhan, Ontario, CA (US)
- (72) Inventors: **Jay Clarke Hanan**, Ontario, CA (US);
Zachary Curhan, Ontario, CA (US)
- (73) Assignee: **Niagara Bottling, LLC**, Ontario, CA (US)
- (**) Term: **15 Years**
- (21) Appl. No.: **29/543,353**
- (22) Filed: **Oct. 23, 2015**
- (51) **LOC (11) Cl.** **09-01**
- (52) **U.S. Cl.**
USPC **D9/550; D9/520; D9/558**
- (58) **Field of Classification Search**
USPC D9/500, 502-503, 516, 520, 530,
D9/537-539, 549-550, 557-558, 715, 719
CPC B65D 1/00; B65D 1/02; B65D 1/0223;
B65D 23/00; B65D 81/00; B65D
2501/00; B65D 2501/0009
See application file for complete search history.

- (56) **References Cited**
U.S. PATENT DOCUMENTS
D222,851 S * 1/1972 Adomaitis D9/501
D301,203 S 5/1989 Jolly et al.
D328,420 S 8/1992 Miller
D328,430 S 8/1992 Miller
D364,347 S * 11/1995 Sillince D9/500
D461,674 S 8/2002 Dorney
D476,896 S 7/2003 Cheng et al.
6,634,517 B2 * 10/2003 Cheng B65D 1/0276
215/371
6,659,298 B2 12/2003 Wong
D543,462 S * 5/2007 Pedmo D9/520

- D546,183 S 7/2007 Clutter
 - D569,729 S 5/2008 Pedmo et al.
 - D572,590 S 7/2008 Coulis et al.
 - D592,060 S 5/2009 Chupak
 - D600,556 S 9/2009 Chupak
 - D630,513 S * 1/2011 Zoppas D9/500
 - 8,097,662 B2 * 1/2012 Schmidt A23L 3/3436
428/35.7
 - 8,309,622 B2 * 11/2012 Schmidt A23L 3/3436
428/35.7
 - D696,946 S 1/2014 Hines
 - D697,804 S 1/2014 Hanson et al.
 - D706,633 S 6/2014 Reisig et al.
 - D706,634 S 6/2014 Herman et al.
 - D711,246 S 8/2014 Hanson et al.
 - D718,635 S * 12/2014 Fleischhacker D9/539
- (Continued)

Primary Examiner — Dana L Meyrow
(74) *Attorney, Agent, or Firm* — Rutan & Tucker LLP;
Hani Z. Sayed

(57) **CLAIM**
The ornamental design for an plastic utility bottle with narrow neck, as shown and described.

DESCRIPTION

FIG. 1—Top, front, right side perspective view of the present invention;
FIG. 2—Top plan view;
FIG. 3—Bottom plan view;
FIG. 4—Front elevation view;
FIG. 5—Rear elevation view;
FIG. 6—Left side elevation view; and,
FIG. 7—Right side elevation view.
The short dashed broken lines in the drawings illustrate the portions of the plastic utility bottle with narrow neck that form no part of the claim. The long dashed broken lines in the drawings define the bounds of the claim and form no part thereof.

1 Claim, 3 Drawing Sheets

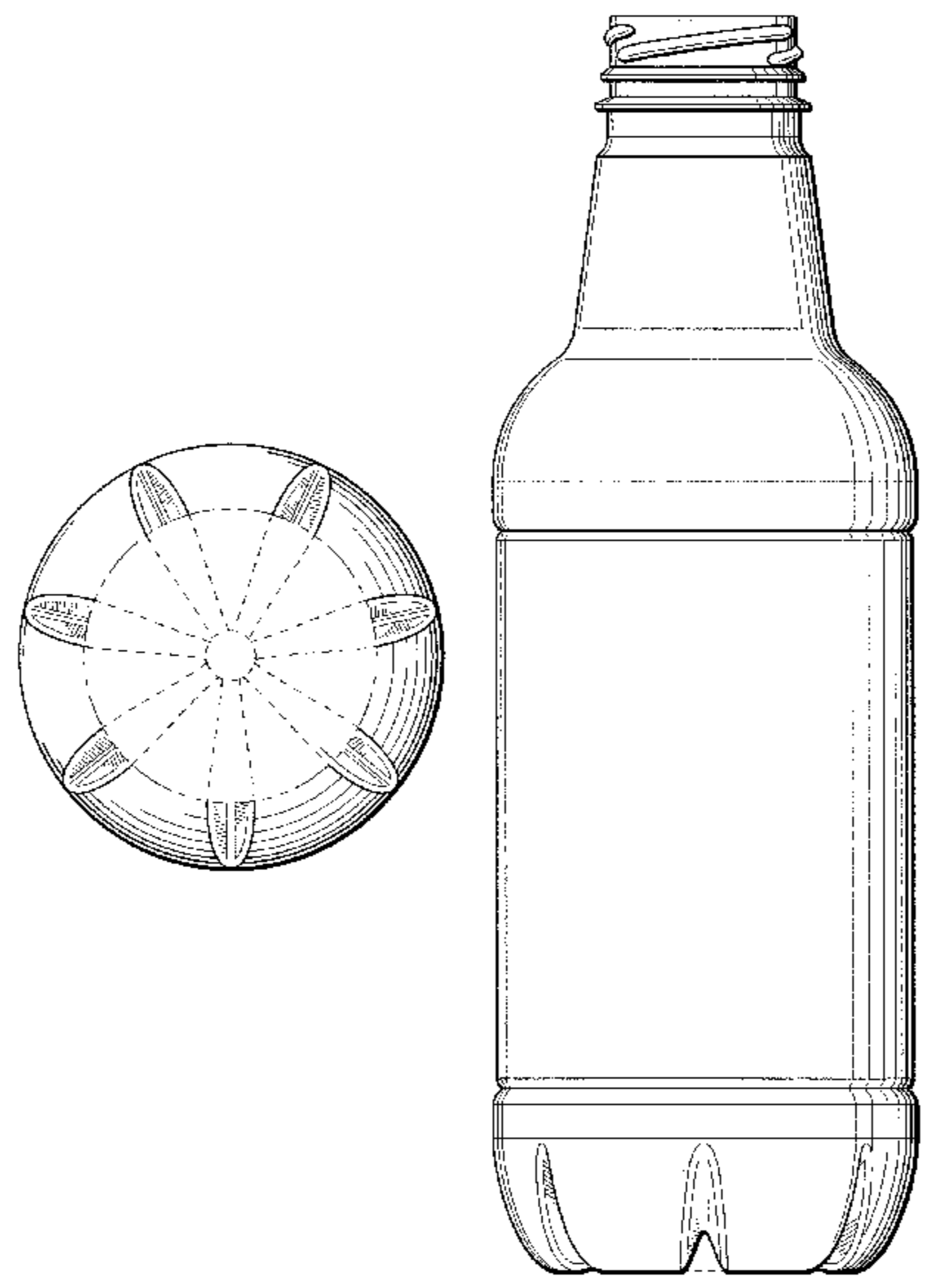

(56)

References Cited

U.S. PATENT DOCUMENTS

D732,968 S *	6/2015	Heisner	D9/500
D739,245 S *	9/2015	Dachs	B65D 1/0284
			D9/516
2003/0042221 A1*	3/2003	Wong	B65D 1/0276
			215/373

* cited by examiner

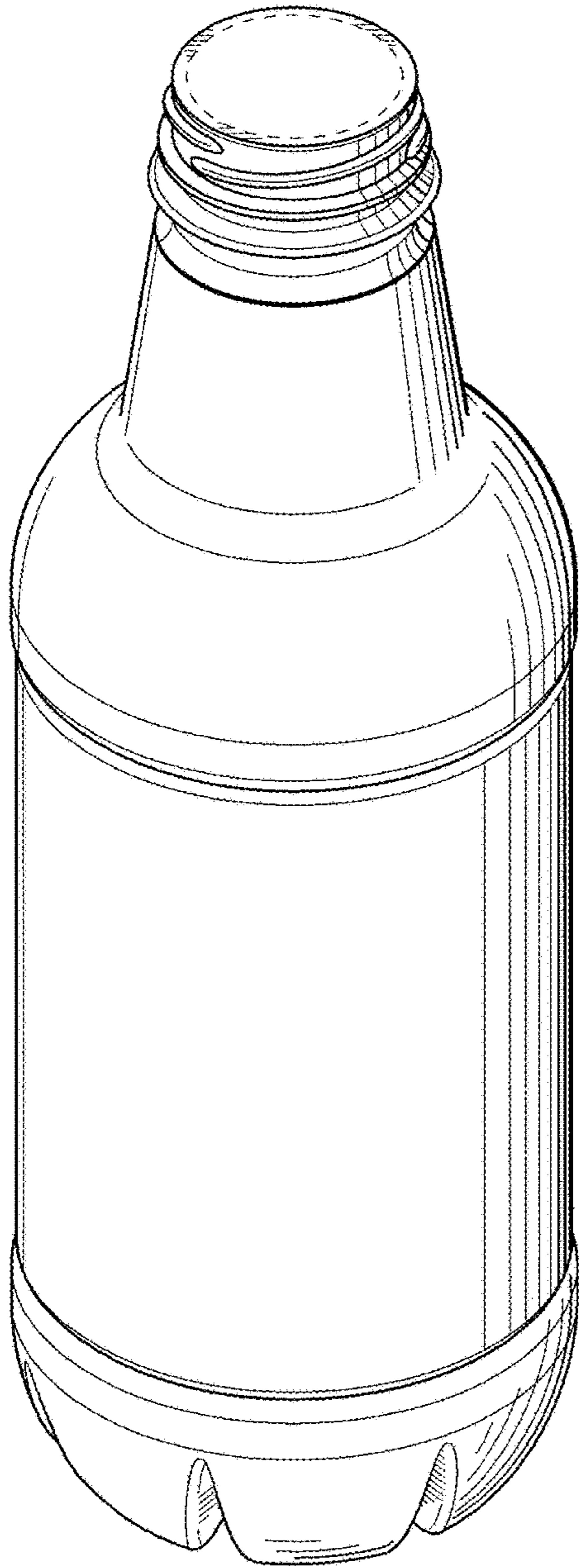

FIG. 1

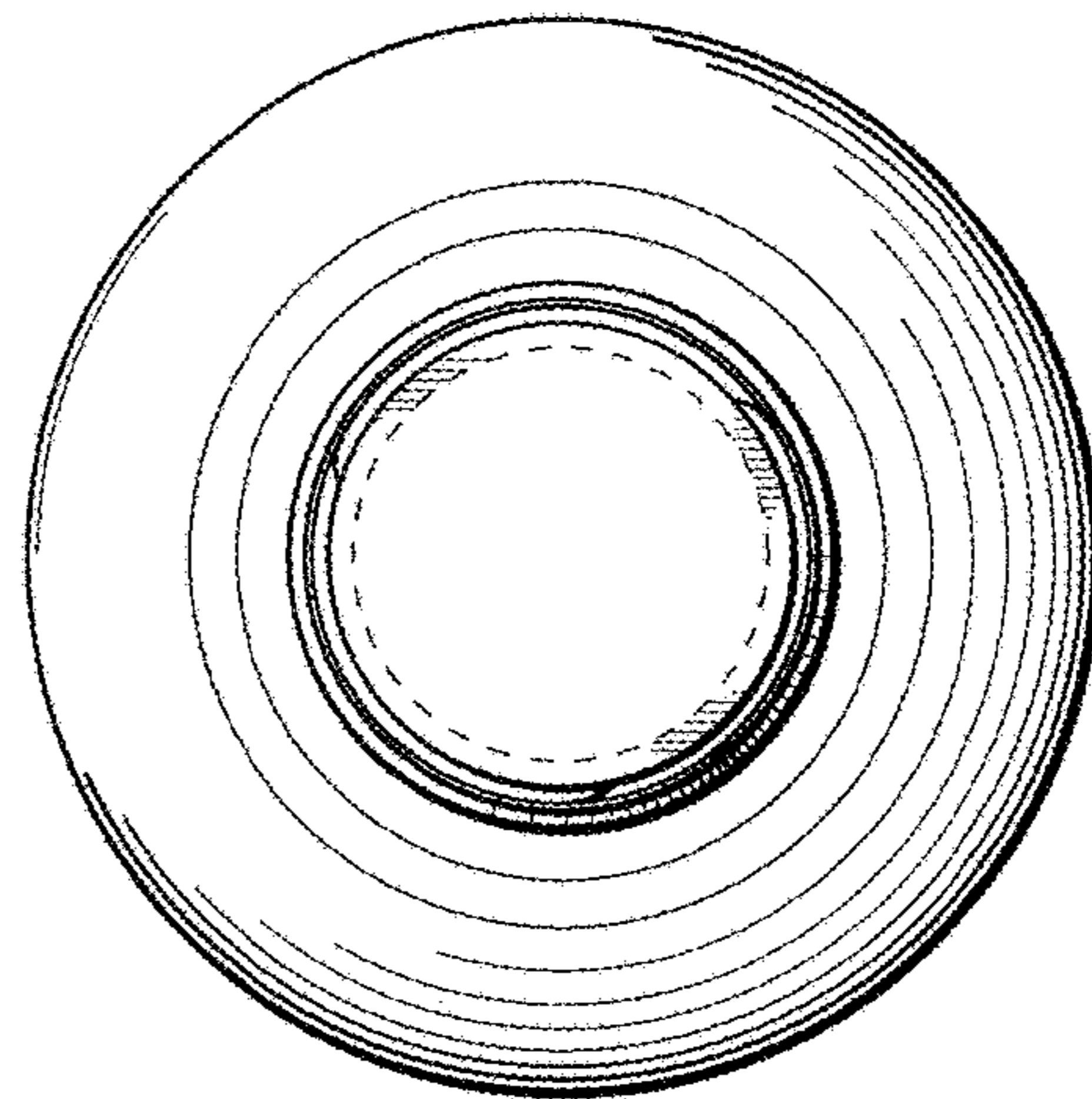

FIG. 2

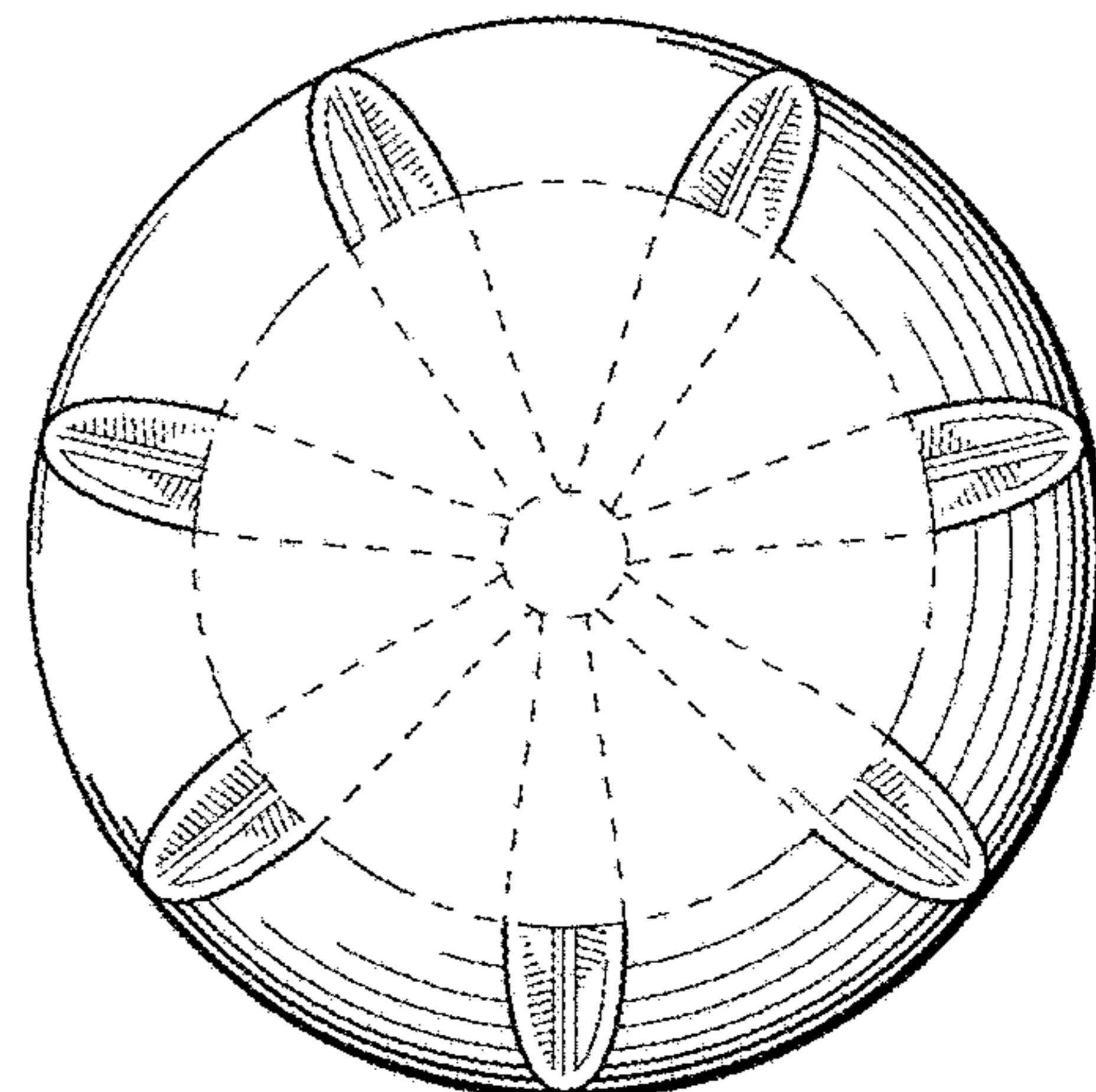

FIG. 3

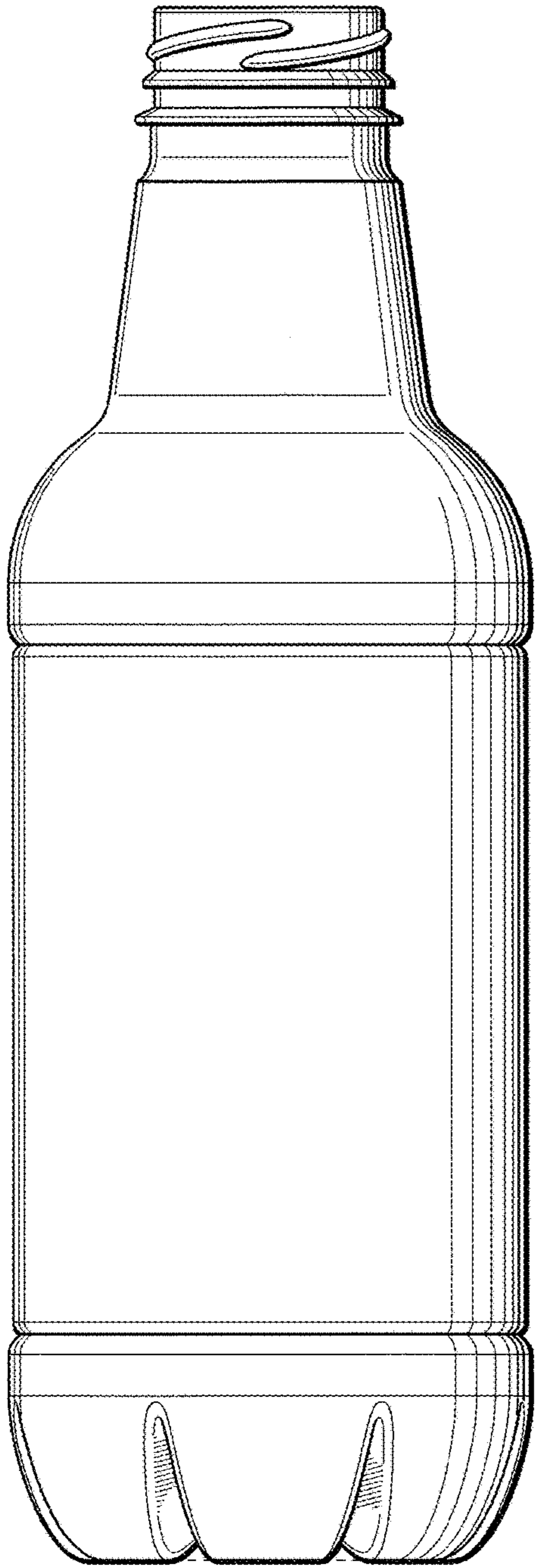

FIG. 4

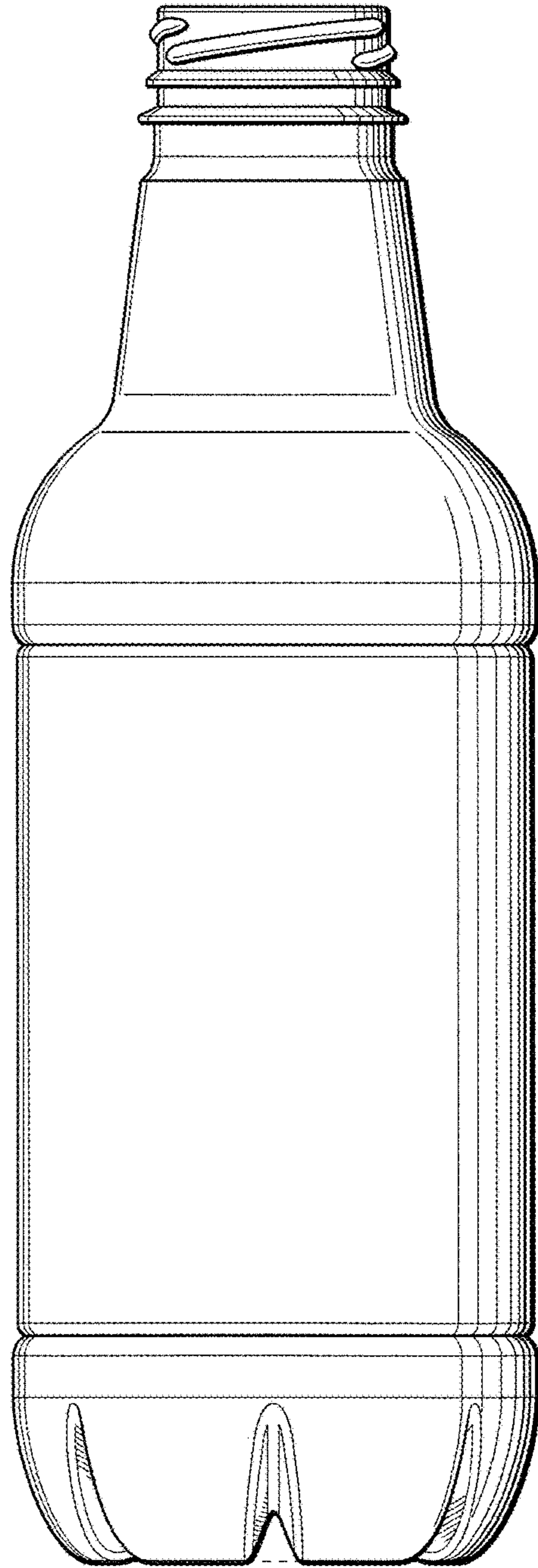

FIG. 5

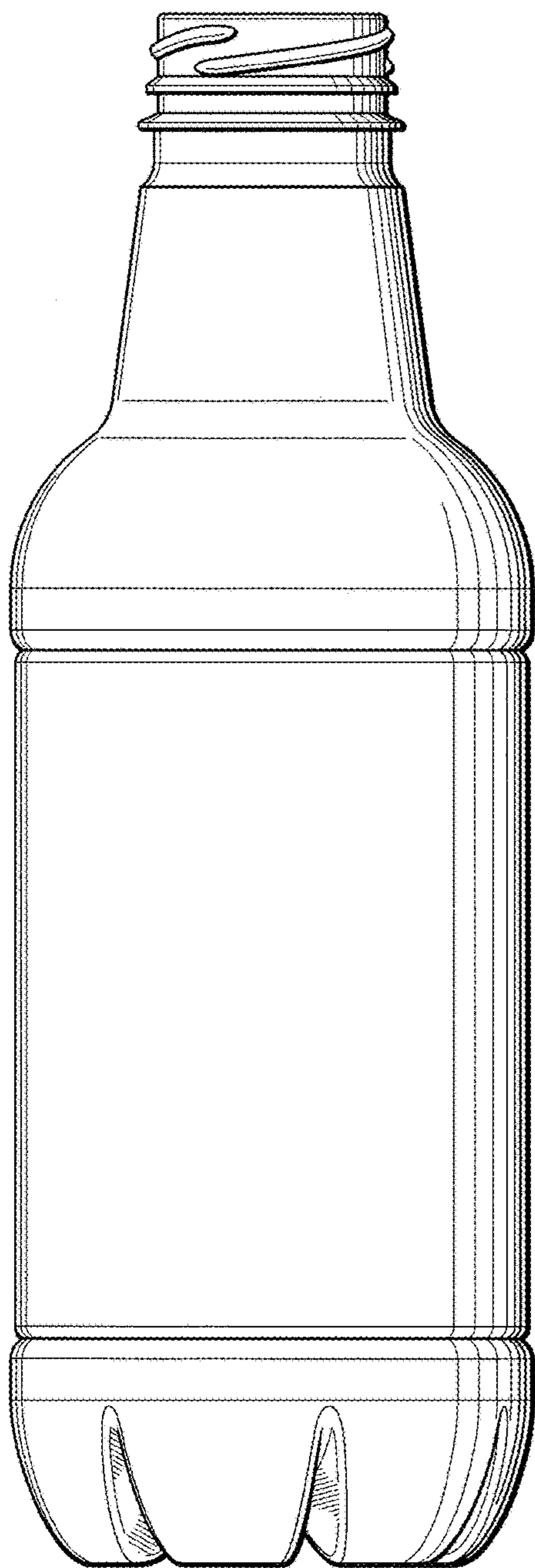

FIG. 6

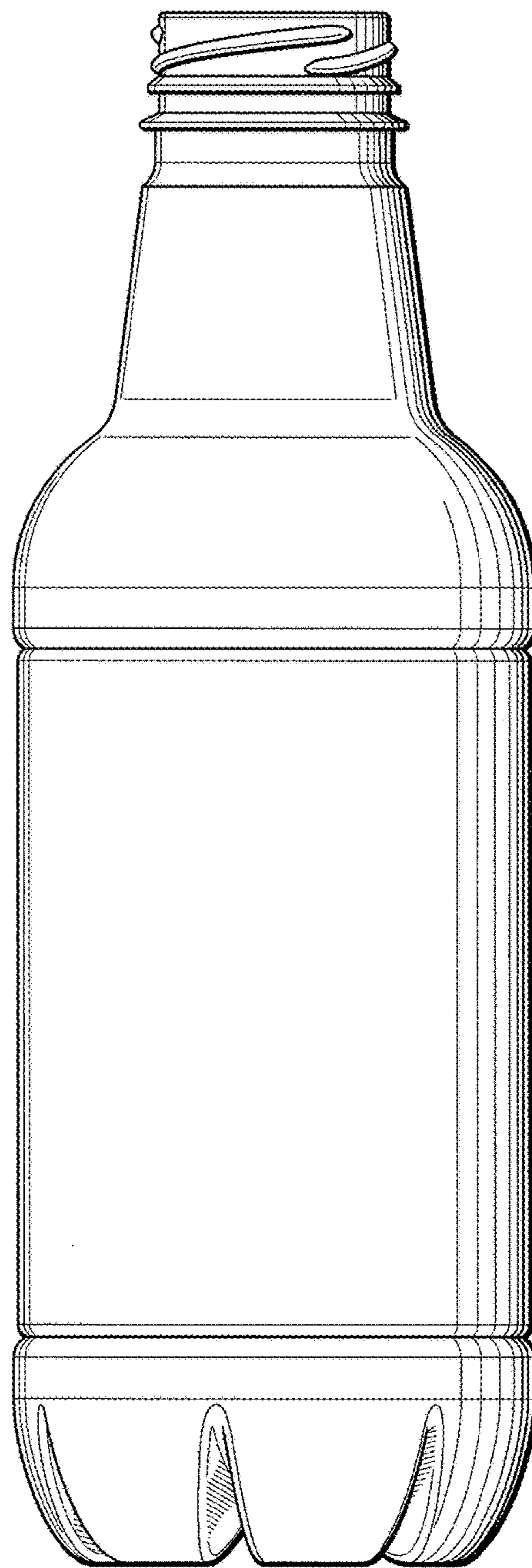

FIG. 7

UNITED STATES PATENT AND TRADEMARK OFFICE
CERTIFICATE OF CORRECTION

PATENT NO. : D818,368 S
APPLICATION NO. : 29/543353
DATED : May 22, 2018
INVENTOR(S) : Jay Clarke Hanan et al.

Page 1 of 1

It is certified that error appears in the above-identified patent and that said Letters Patent is hereby corrected as shown below:

On the Title Page

Item (72) please correct:

(72) Inventors: Jay Clarke Hanan, Ontario, CA (US)
Zachary Curhan, Ontario, CA (US)

To read:

(72) Inventors: Jay Clarke Hanan, Ontario, CA (US)
Zachary Curhan, Ontario, CA (US)
Theo Goldin, San Francisco, CA (US)

Signed and Sealed this
Twenty-third Day of June, 2020

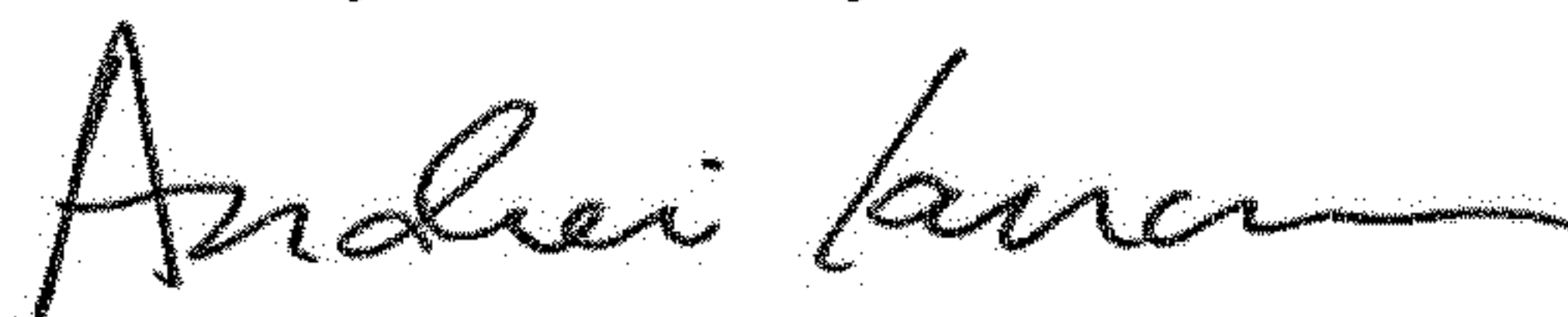

Andrei Iancu
Director of the United States Patent and Trademark Office