



US00D818337S

(12) **United States Design Patent** (10) **Patent No.:** **US D818,337 S**
Nelson (45) **Date of Patent:** **** May 22, 2018**

(54) **AXE**
(71) Applicant: **Home Depot Product Authority, LLC**,
Atlanta, GA (US)
(72) Inventor: **Michael R. Nelson**, Peachtree City, GA
(US)
(73) Assignee: **Home Depot Product Authority, LLC**,
Atlanta, GA (US)
(**) Term: **15 Years**
(21) Appl. No.: **29/559,118**
(22) Filed: **Mar. 24, 2016**
(51) **LOC (11) Cl.** **08-02**
(52) **U.S. Cl.**
USPC **D8/76**
(58) **Field of Classification Search**
USPC D8/1, 11, 75-81, 107, 303
CPC A01B 1/20; A01B 1/227; A01G 23/099;
B25D 1/00; B25D 1/045; B25D 1/06;
B25G 1/10; B25G 1/01; B25G 1/08;
B25G 3/28; B25G 3/34; B26B 23/00;
B27L 7/06
See application file for complete search history.

4,344,901 A * 8/1982 Keathley B25G 3/34
264/261
D318,896 S * 8/1991 Crain D22/117
D354,212 S * 1/1995 Ronnholm D8/76
5,701,675 A * 12/1997 Hall B25G 1/08
30/123
D402,874 S * 12/1998 Hall D8/76
D519,813 S * 5/2006 Hung D8/76
D521,843 S * 5/2006 Hung D8/76
D583,641 S * 12/2008 Fortier D8/76
D594,727 S * 6/2009 Fortier D8/76
D628,870 S * 12/2010 Jerabek D8/78
D685,246 S * 7/2013 Tatic D8/76
D758,818 S * 6/2016 Nelson D8/80
D760,054 S * 6/2016 Huttunen D8/76
D760,055 S * 6/2016 Nelson D8/80
D769,098 S * 10/2016 Huttunen D8/76
D769,688 S * 10/2016 Nelson D8/80

(Continued)

OTHER PUBLICATIONS

<http://www.homedepot.com/p/Husky-1-1-4-lb-Premium-Camp-Axe-with-14-in-Fiberglass-...> Downloaded Sep. 13, 2017.*

Primary Examiner — Phillip S Hyder
Assistant Examiner — Roselyne Cody
(74) *Attorney, Agent, or Firm* — Greenberg Traurig, LLP

(57) **CLAIM**

The ornamental design for an axe, as shown and described.

DESCRIPTION

FIG. 1 is a perspective view of my design;
FIG. 2 is a front view thereof;
FIG. 3 is a rear view thereof;
FIG. 4 is a right view thereof;
FIG. 5 is a left view thereof;
FIG. 6 is a top view thereof; and,
FIG. 7 is a bottom view thereof.
The broken lines in the drawings depict features of the axe that forms no part of the claim.

1 Claim, 4 Drawing Sheets

(56) **References Cited**
U.S. PATENT DOCUMENTS
D20,771 S * 5/1891 Hubbard D8/76
D29,680 S * 11/1898 Kelly 30/308.1
1,943,807 A * 1/1934 Bellerive B25G 1/10
174/138 R
D117,803 S * 11/1939 Vaughan D8/76
3,090,653 A * 5/1963 Stump B25G 3/28
285/915
D209,381 S * 11/1967 Reuterfors D8/76
D243,314 S * 2/1977 Hedvall D8/76
4,287,640 A * 9/1981 Keathley B25G 3/34
125/43

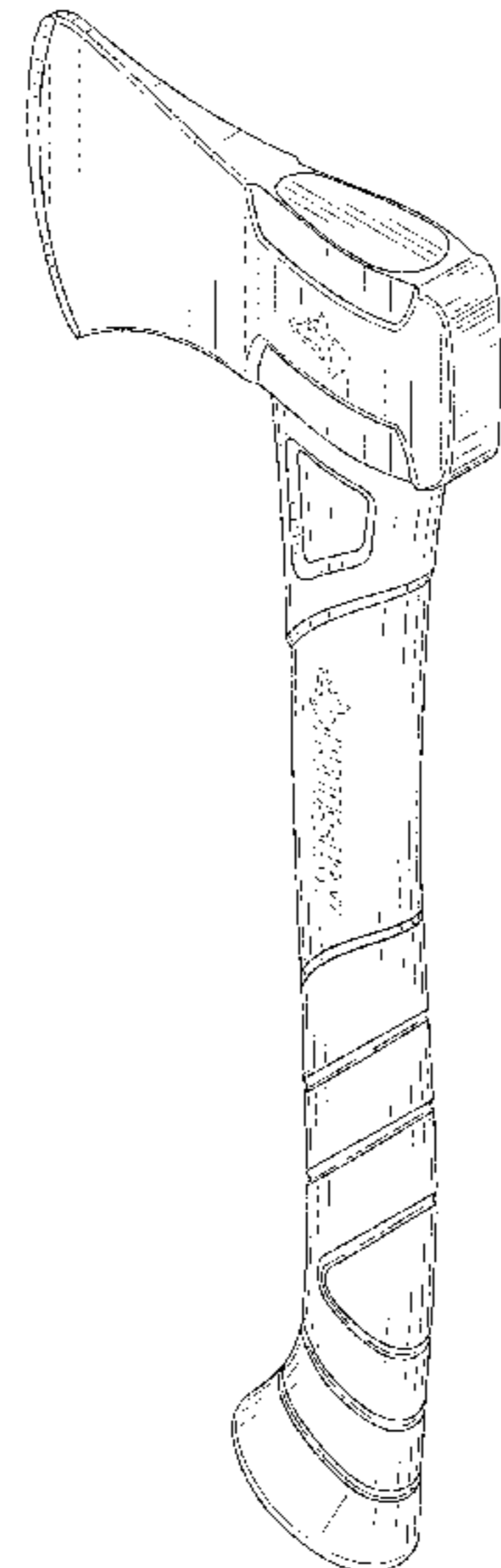

(56)

References Cited

U.S. PATENT DOCUMENTS

D770,257 S	*	11/2016	Stokes	D8/75
D770,258 S	*	11/2016	Stokes	D8/76
D772,671 S	*	11/2016	Stokes	D8/75
D784,784 S	*	4/2017	Huttunen	D8/80
2016/0008966 A1	*	1/2016	Stokes	B25G 1/01 81/22

* cited by examiner

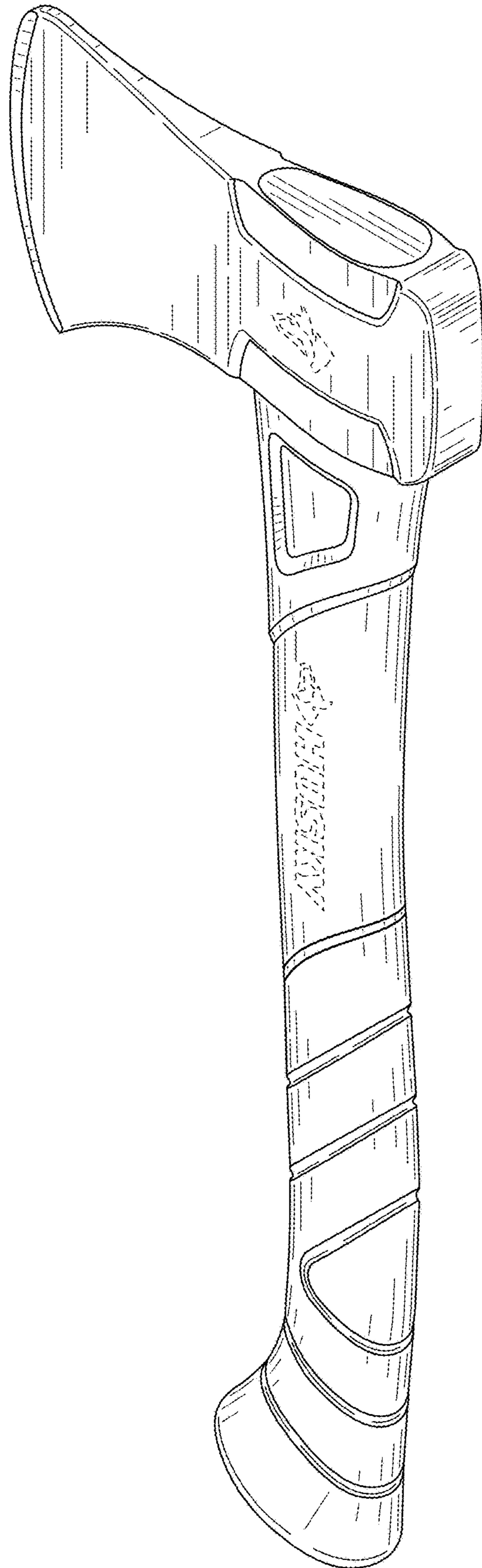

FIG. 1

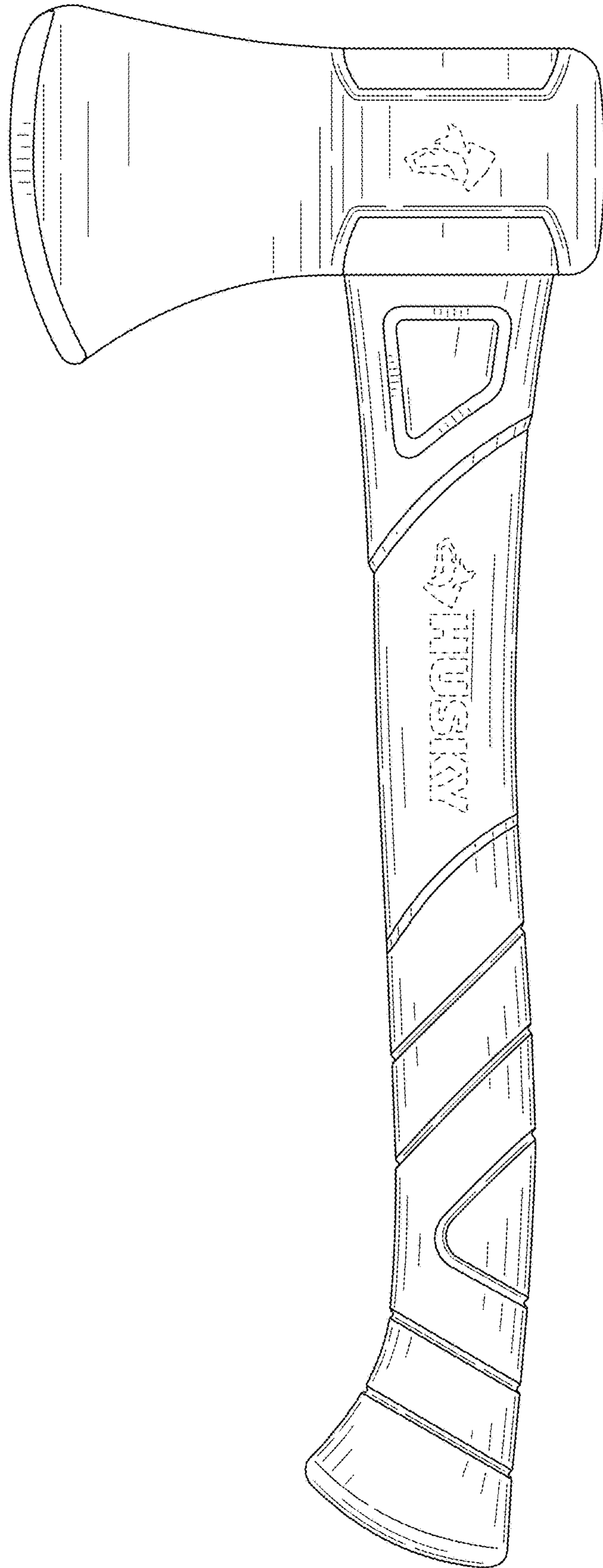

FIG. 2

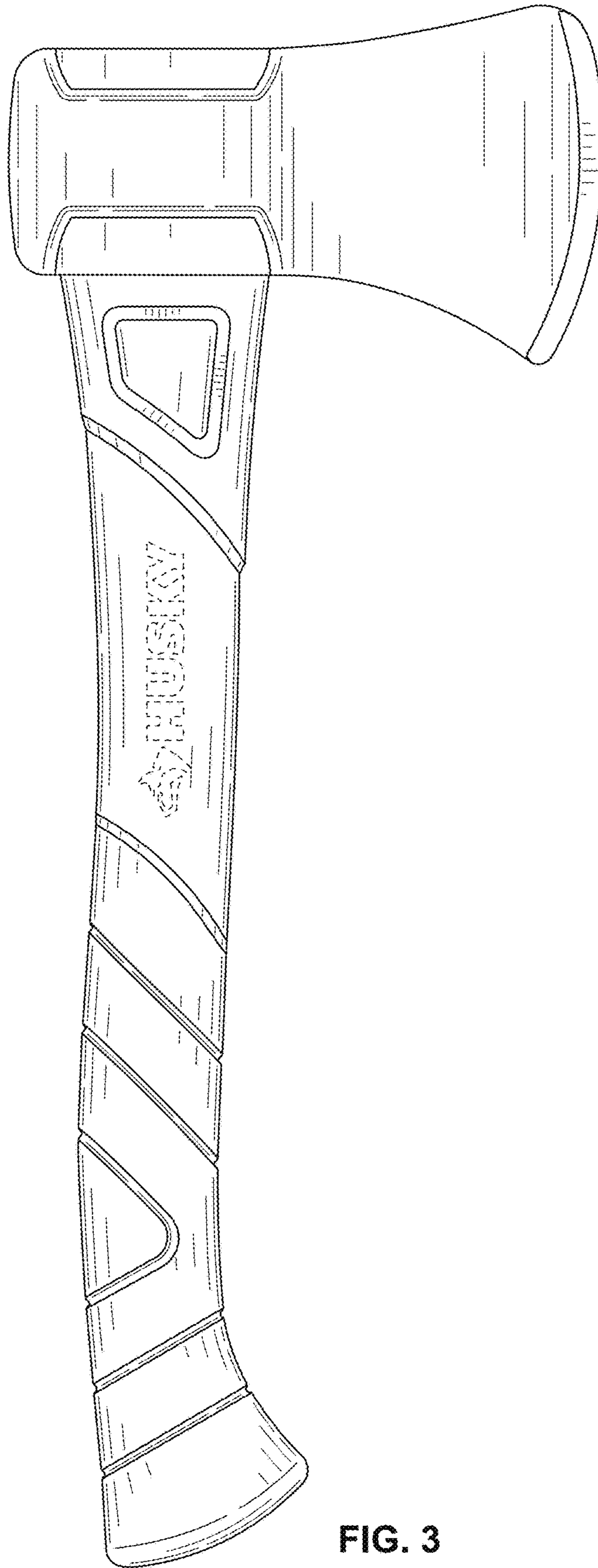

FIG. 3

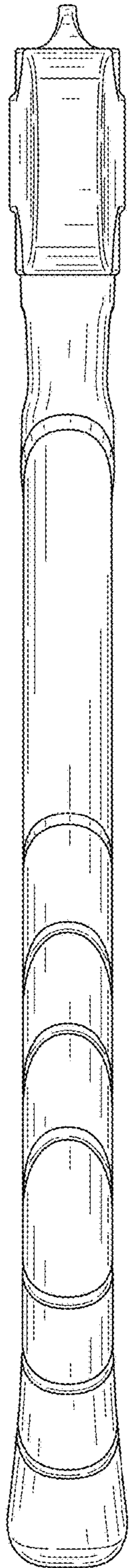

FIG. 4

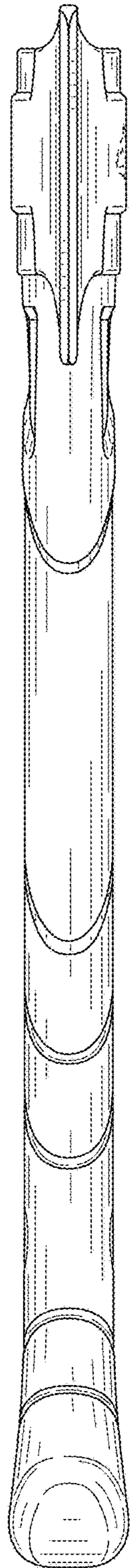

FIG. 5

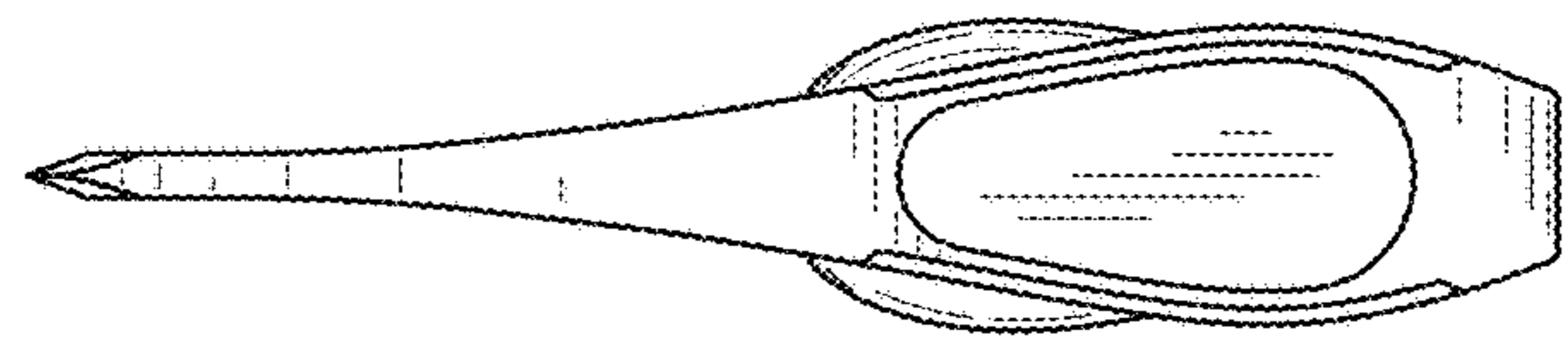

FIG. 6

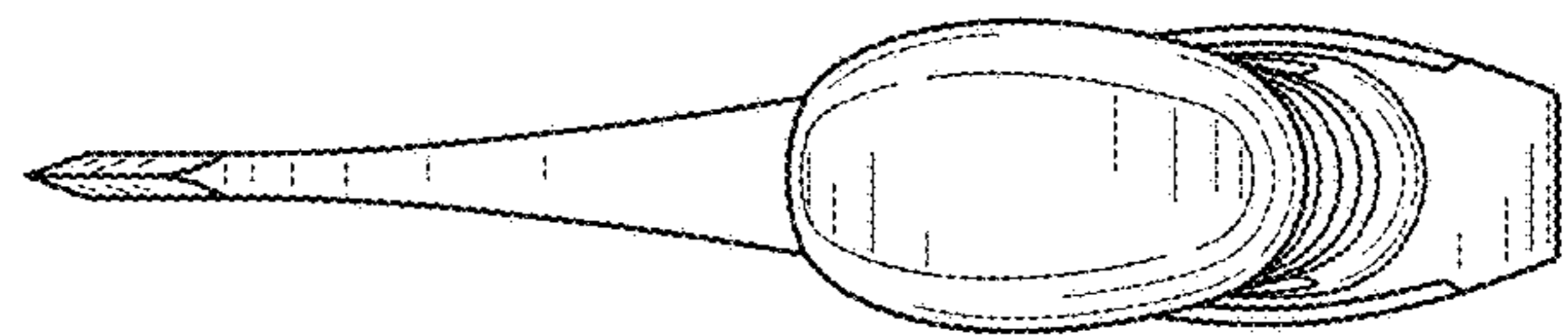

FIG. 7