



US00D818221S

(12) **United States Design Patent**
Ha et al.

(10) **Patent No.:** **US D818,221 S**

(45) **Date of Patent:** **** May 15, 2018**

(54) **WASHING MACHINE**

(56) **References Cited**

(71) Applicant: **LG ELECTRONICS INC.**, Seoul (KR)

U.S. PATENT DOCUMENTS

(72) Inventors: **Youngsoo Ha**, Seoul (KR); **Taewoo Yoo**, Seoul (KR); **Eunyoung Chee**, Seoul (KR); **Jeaseok Seong**, Seoul (KR)

D374,521 S	*	10/1996	Jackovin	D32/5
D556,956 S	*	12/2007	Kim	D32/6
D588,757 S	*	3/2009	Park	D32/6
D688,427 S	*	8/2013	Meda	D32/6
D692,194 S	*	10/2013	Meda	D32/6
D695,472 S	*	12/2013	Borjesson	D32/6
D730,596 S	*	5/2015	Kim	D32/6
D739,098 S	*	9/2015	Qin	D32/6
D770,103 S	*	10/2016	Ha	D32/6
D770,706 S	*	11/2016	Ha	D32/6
D770,707 S	*	11/2016	Ha	D32/6
D771,330 S	*	11/2016	Ha	D32/6
D774,715 S	*	12/2016	Kim	D32/6
D808,093 S	*	1/2018	Ha	D32/6
D808,094 S	*	1/2018	Ha	D32/6

(73) Assignee: **LG Electronics Inc.**, Seoul (KR)

(**) Term: **15 Years**

(21) Appl. No.: **35/502,571**

(22) Filed: **Sep. 8, 2016**

* cited by examiner

(80) **Hague Agreement Data**

Int. Filing Date: **Sep. 8, 2016**
Int. Reg. No.: **DM/092468**
Int. Reg. Date: **Sep. 8, 2016**
Int. Reg. Pub. Date: **Mar. 10, 2017**

Primary Examiner — Michael A. Pratt

(74) *Attorney, Agent, or Firm* — Birch, Stewart, Kolasch & Birch, LLP

(30) **Foreign Application Priority Data**

Mar. 16, 2016 (KR) 30-2016-0012189

(51) **LOC (11) Cl.** **15-05**

(52) **U.S. Cl.**
USPC **D32/6**

(58) **Field of Classification Search**

USPC D32/6, 8, 9
CPC D06F 39/045; D06F 29/00; D06F 29/005;
D06F 25/00; D06F 39/022; D06F 33/02;
D06F 2204/065; D06F 35/006

See application file for complete search history.

(57) **CLAIM**

The ornamental design for a washing machine, as shown and described.

DESCRIPTION

1. Washing machine
- 1.1 is a Perspective View;
- 1.2 is a Front Elevation View;
- 1.3 is a Rear Elevation View;
- 1.4 is a Left Side View;
- 1.5 is a Right Side View;
- 1.6 is a Top Plan view; and
- 1.7 is a Bottom Plan View.

1 Claim, 7 Drawing Sheets

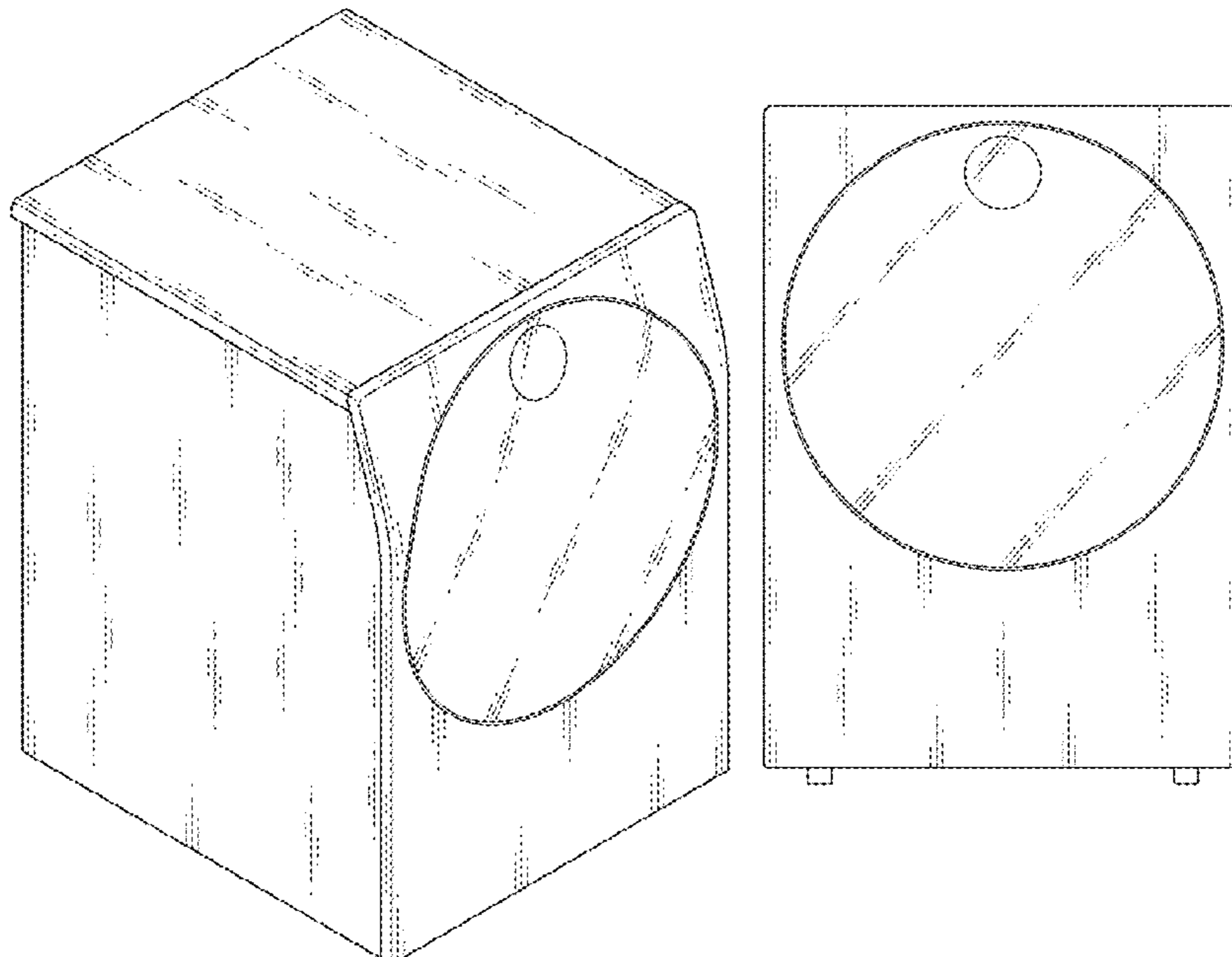

1.1

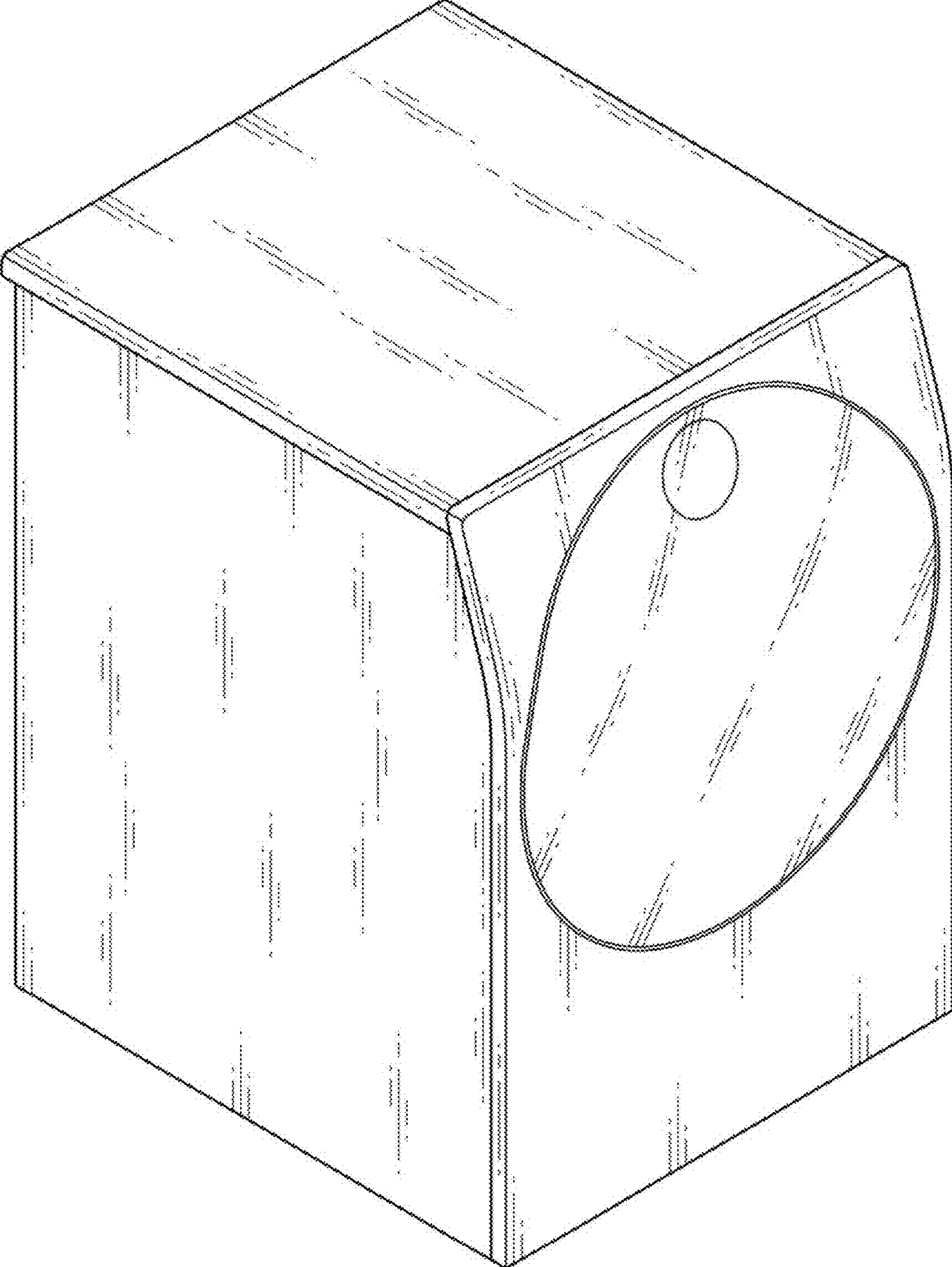

1.2

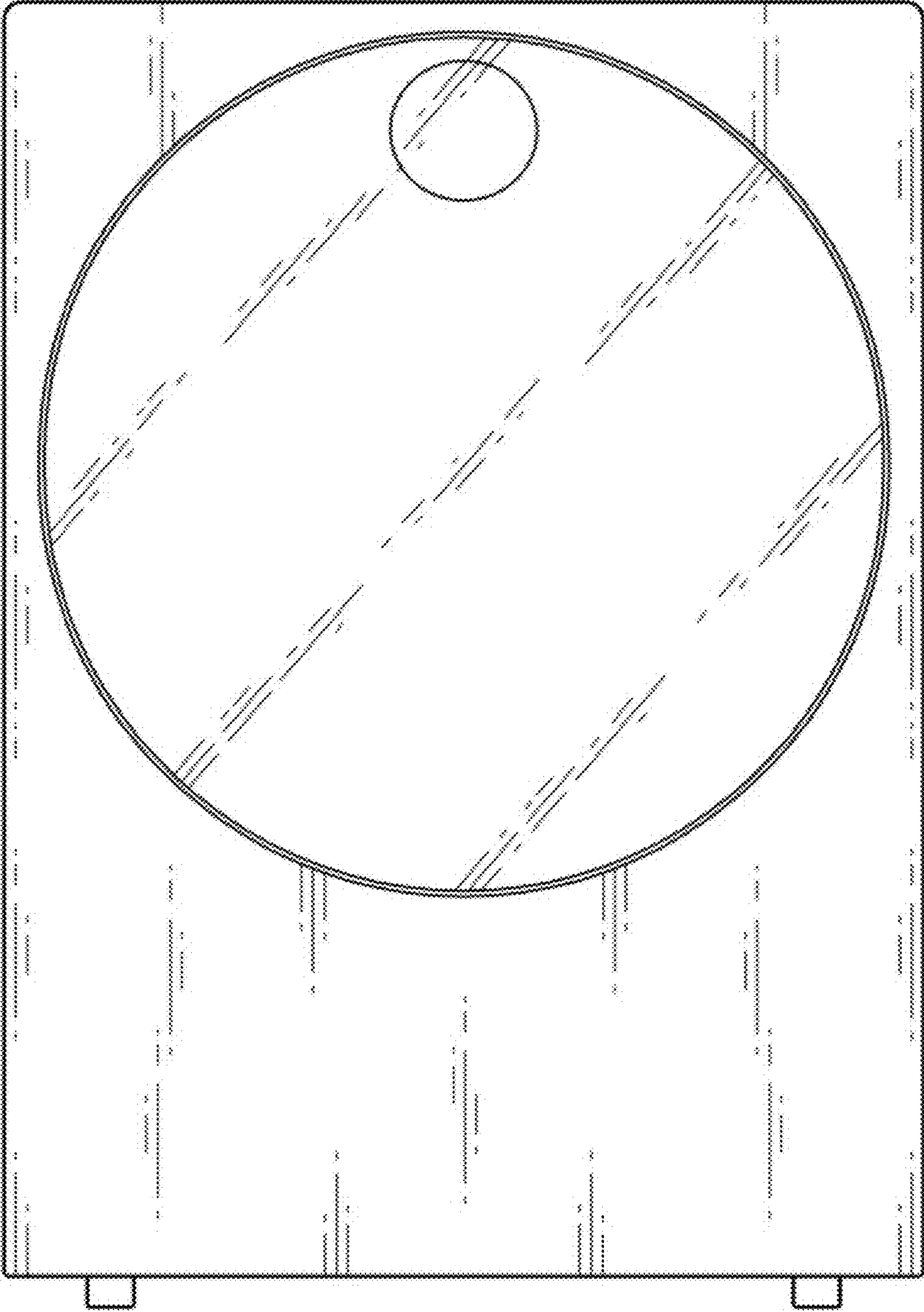

1.3

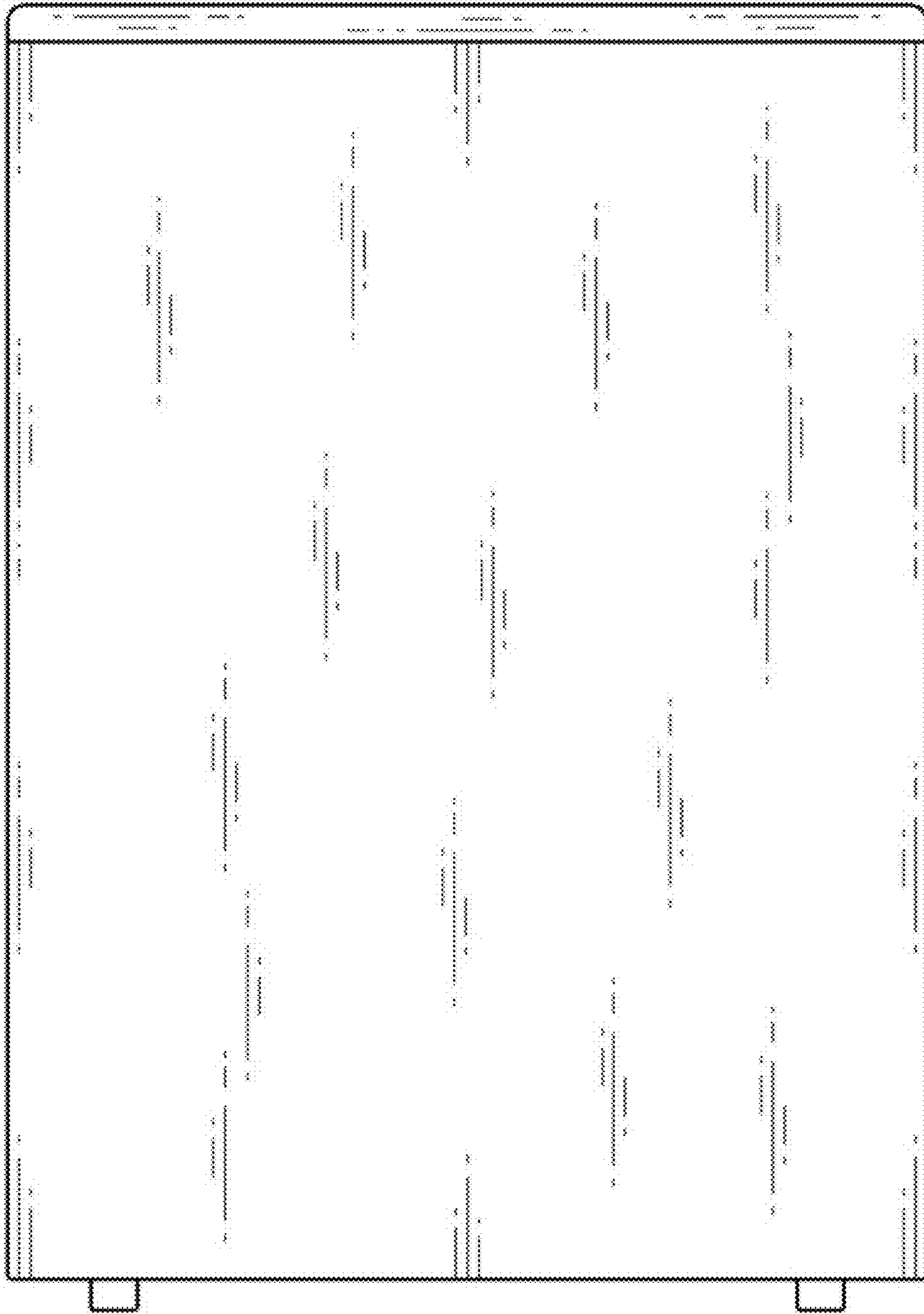

1.4

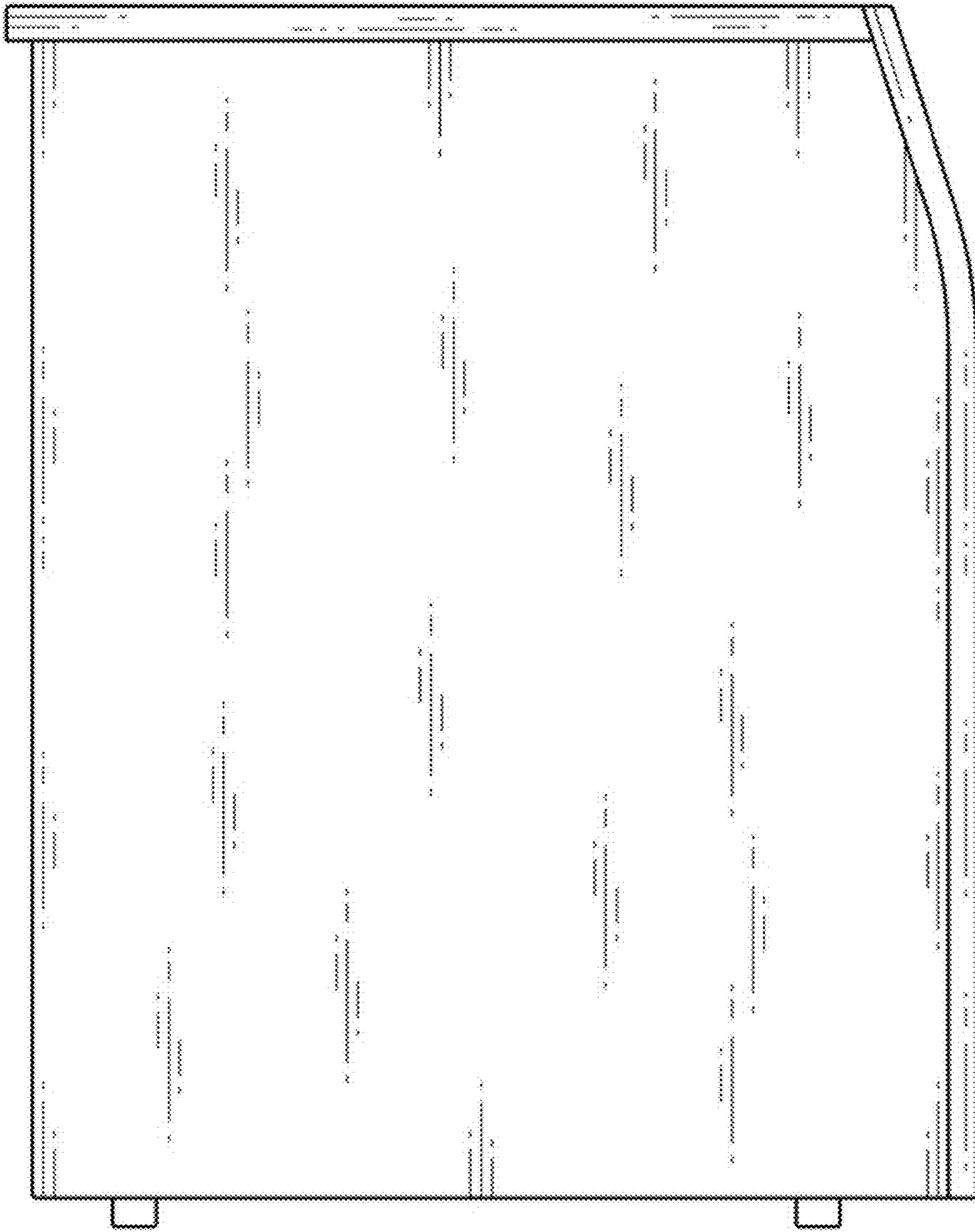

1.5

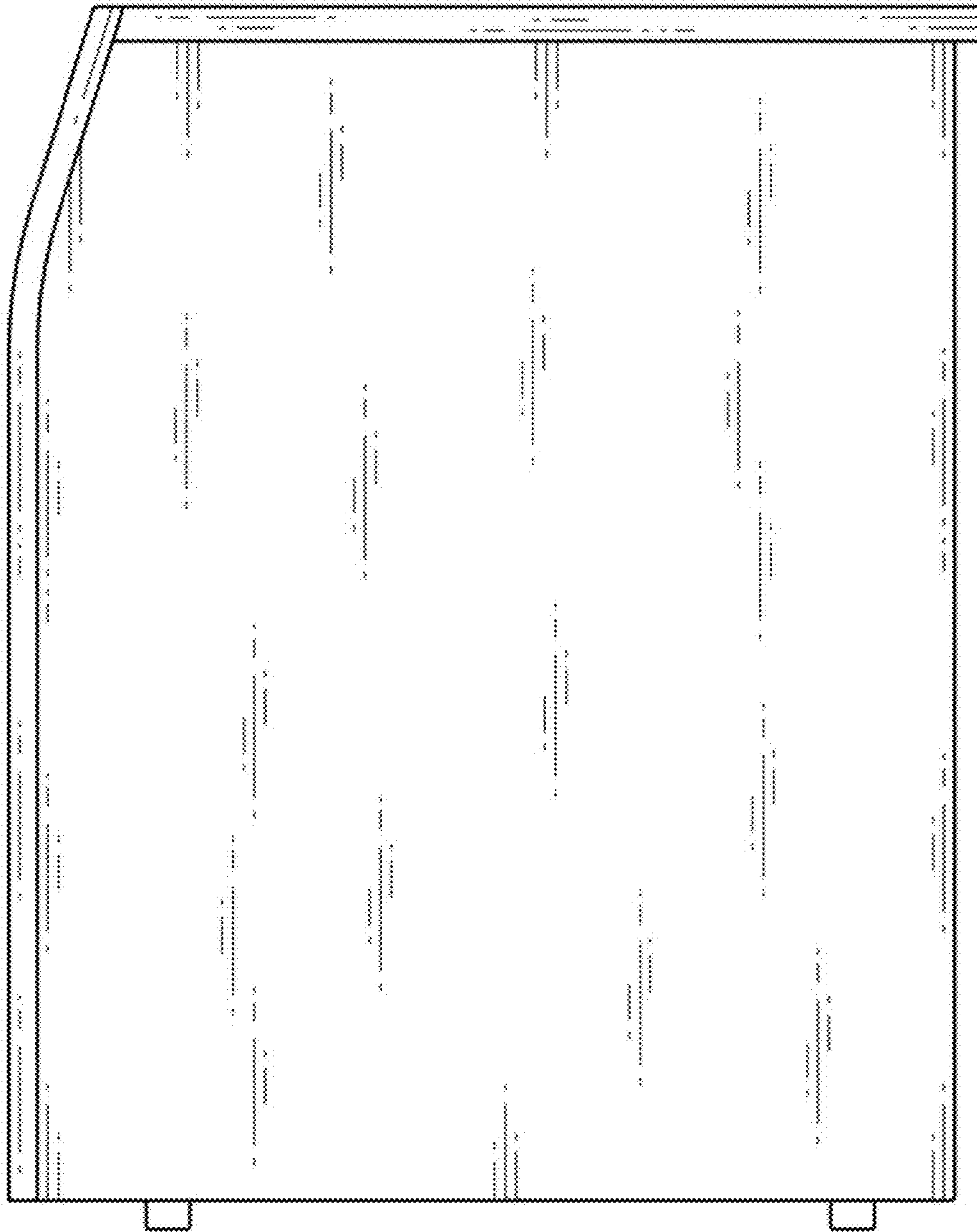

1.6

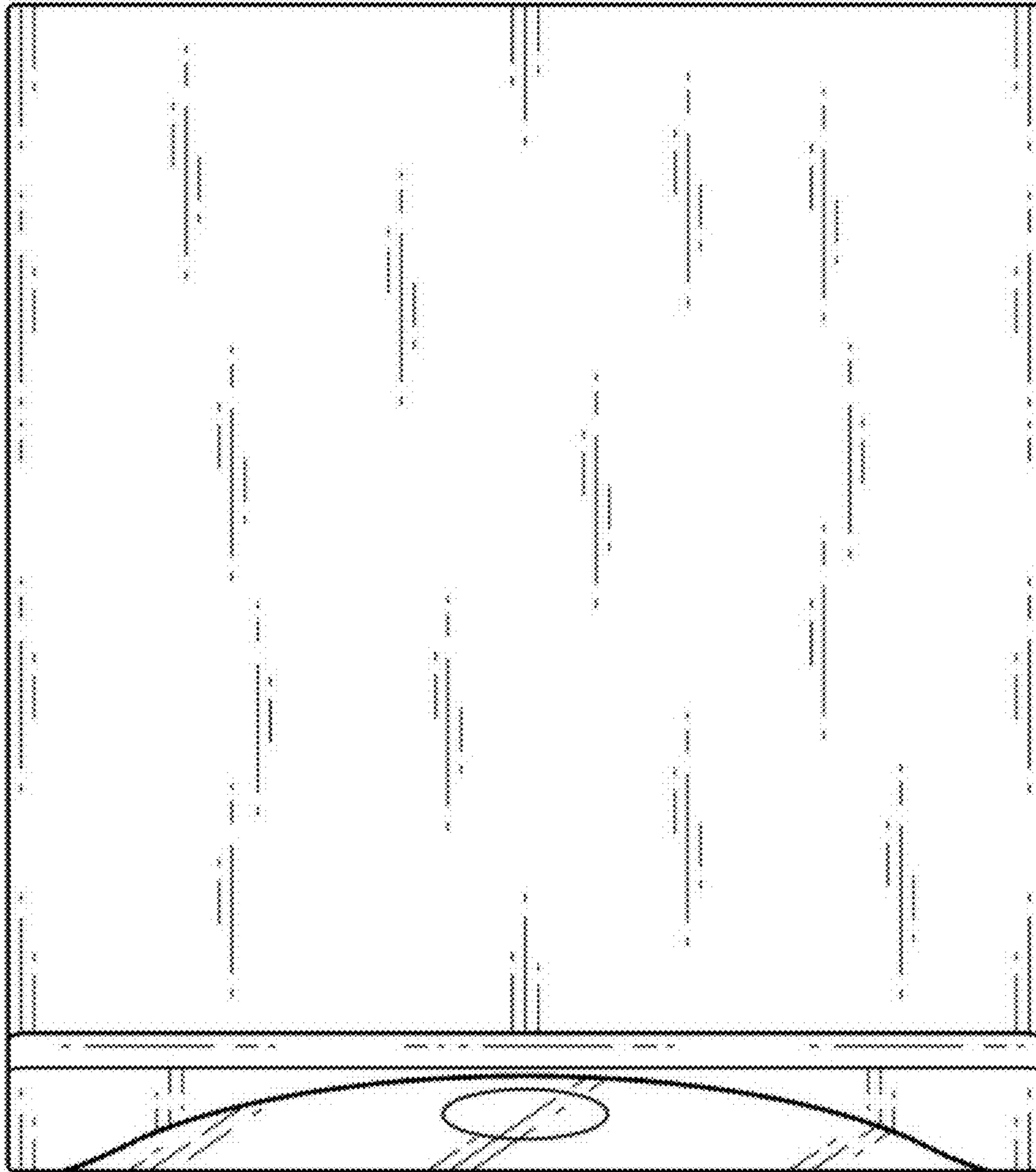

1.7

