



US00D818210S

(12) **United States Design Patent** (10) **Patent No.:** **US D818,210 S**
Petterson (45) **Date of Patent:** **** May 15, 2018**

(54) **LEG COVER FOR HORSES**

- (71) Applicant: **Raymond Petterson**, Tallahassee, FL (US)
- (72) Inventor: **Raymond Petterson**, Tallahassee, FL (US)
- (**) Term: **15 Years**
- (21) Appl. No.: **29/573,547**
- (22) Filed: **Aug. 8, 2016**
- (51) **LOC (11) Cl.** **30-01**
- (52) **U.S. Cl.**
USPC **D30/145**
- (58) **Field of Classification Search**
USPC D30/144, 145, 146, 151, 161, 199;
D24/124, 190; D2/718, 719, 860, 864,
D2/896, 909, 919, 742, 747; D21/604,
D21/605
CPC A01K 13/007; A61D 9/00
See application file for complete search history.

(56) **References Cited**

U.S. PATENT DOCUMENTS

4,834,079	A *	5/1989	Benckhuijsen	A61D 9/00
					54/82
5,005,215	A *	4/1991	McIlquham	A41D 13/001
					119/654
D329,108	S *	9/1992	Boyd	D24/189
D352,369	S *	11/1994	Figoni	D30/144
D376,448	S *	12/1996	Caditz	D30/146
6,508,205	B1 *	1/2003	Zink	A61D 9/00
					119/850
D516,256	S *	2/2006	Dymburt	D30/145
D643,579	S *	8/2011	Hall	D30/146
8,448,610	B1 *	5/2013	Zeitler	A01K 13/007
					119/850
D743,637	S *	11/2015	Ruetenik	D30/144
D755,398	S *	5/2016	Devito	D24/190
D766,523	S *	9/2016	Smith	D30/145
2011/0209673	A1 *	9/2011	Weyerman	A01K 13/007
					119/856

OTHER PUBLICATIONS

“Summer Whinnys Silver Sox”. Found online Jul. 13, 2017 at amazon.com. Page dated May 27, 2014. Retrieved from https://www.amazon.com/Sox-For-Horses-Summer-Whinnys/dp/B00KH7DT9U/ref=cm_cr_arp_d_product_top?ie=UTF8.*

“Allydrew 4 Pack Leg Warmers”. Found online Jul. 13, 2017 at amazon.com. Page dated May 13, 2015. Retrieved from https://www.amazon.com/Allydrew-Warmers-Various-Styles-Toddlers/dp/B00XLSSBNQ/ref=sr_1_44?ie=UTF8&qid=1499979113&sr=8-44&keywords=baby+leg+warmer.*

“Equicrown”. Found online Mar. 31, 2016 at bober.com.pl. Page dated Dec. 31, 2012. Retrieved from <http://bober.com.pl/pl/>.*

“Tough-1 Sport Boot Covers”. Found online Jul. 13, 2017 at amazon.com. Page dated Aug. 17, 2015. Retrieved from https://www.amazon.com/Tough-1-Sport-Covers-Fringe-Patriotic/dp/B003M6Z7XO/ref=sr_1_37?s=pets-supplies&ie=UTF8&qid=1499979523&sr=1-37&keywords=leg+cover.*

* cited by examiner

Primary Examiner — Robert M. Spear
Assistant Examiner — Kendra Leslie Hamilton
 (74) *Attorney, Agent, or Firm* — Adrienne C. Love

(57) **CLAIM**

The ornamental design for a “leg cover for horses,” as shown and described.

DESCRIPTION

FIG. 1 is a top front perspective view of a leg cover for horses, showing my new design in condition of use;
 FIG. 2 is a left side elevation view thereof;
 FIG. 3 is a right side elevation view thereof;
 FIG. 4 is a rear elevation view thereof;
 FIG. 5 is a front elevation view thereof;
 FIG. 6 is a top plan view thereof; and,
 FIG. 7 is a bottom plan view thereof.
 The broken lines showing a horse in FIG. 1 depict environmental matter and form no part of the claimed design. The broken lines on the leg cover in FIGS. 1 through 7 depict stitching that forms no part of the claimed design.

1 Claim, 4 Drawing Sheets

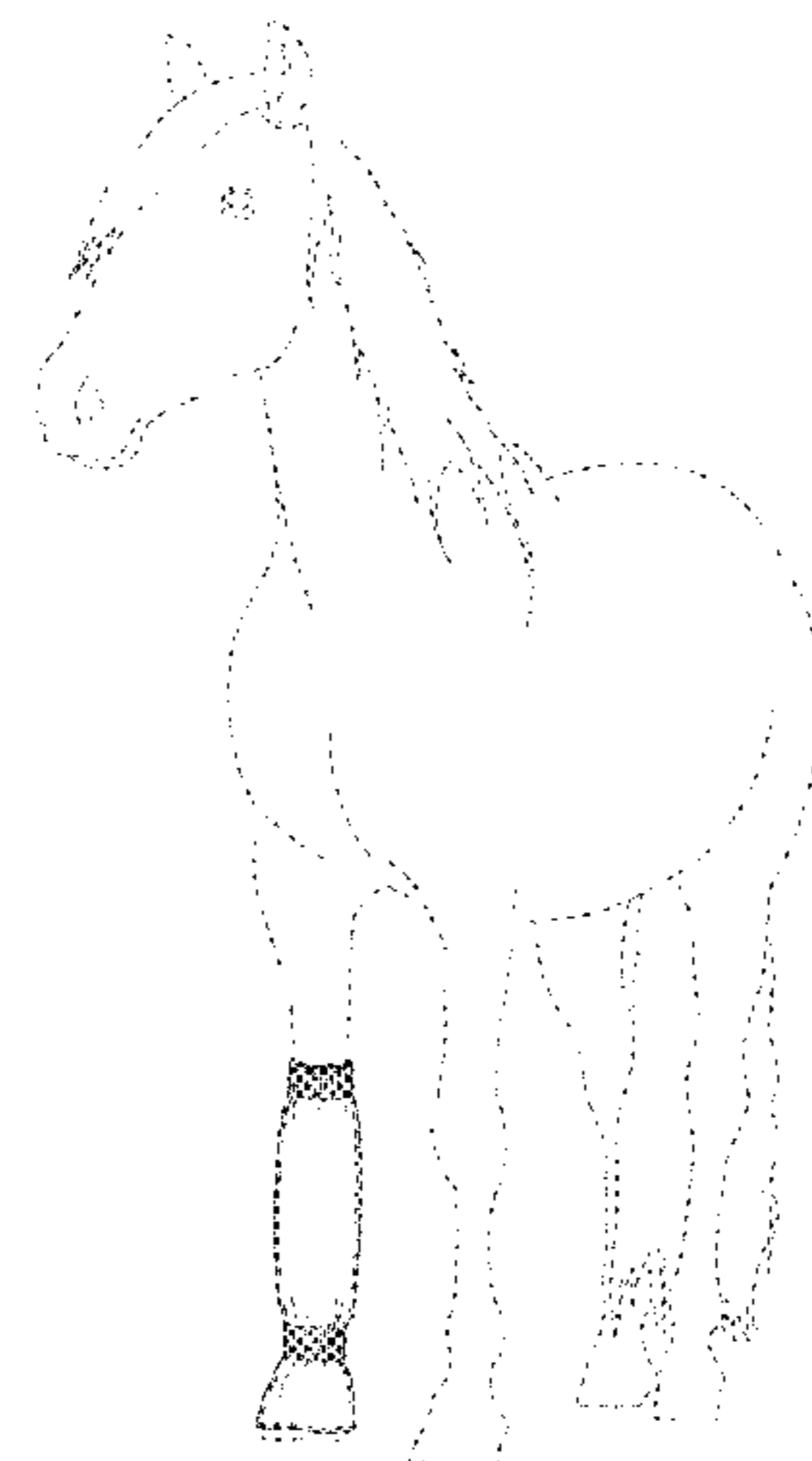



FIG. 1

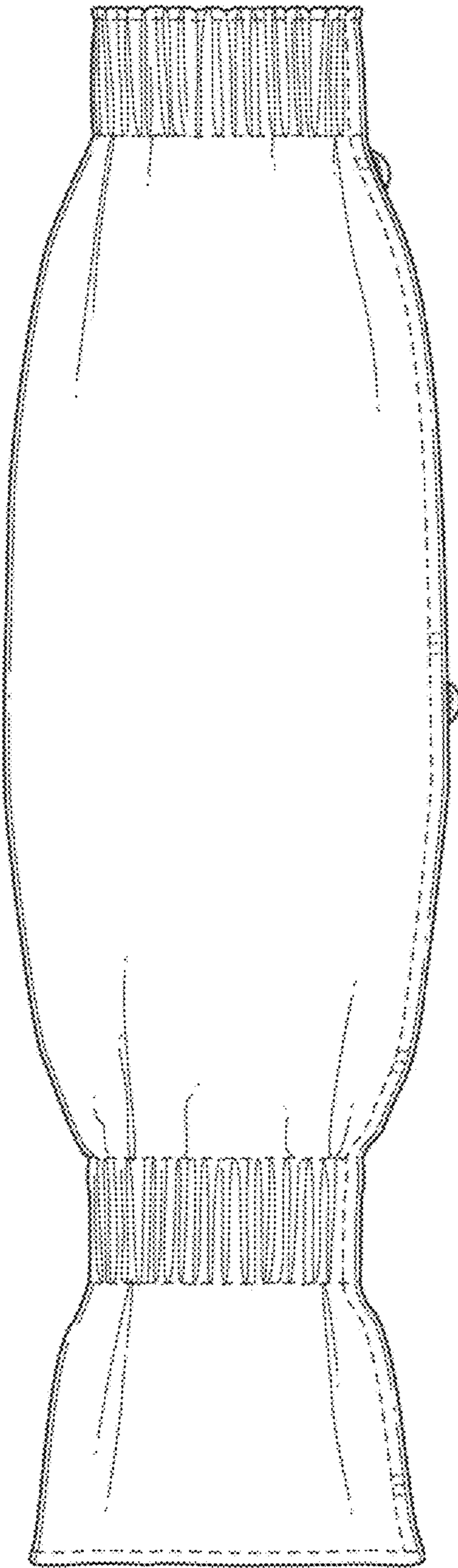

FIG. 2

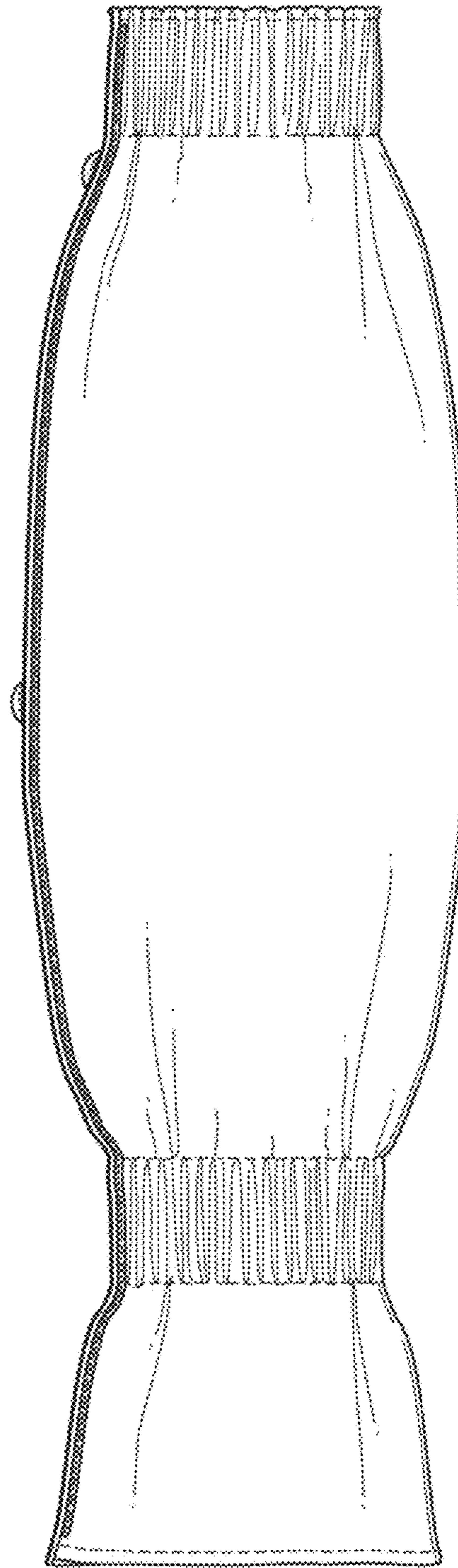

FIG. 3

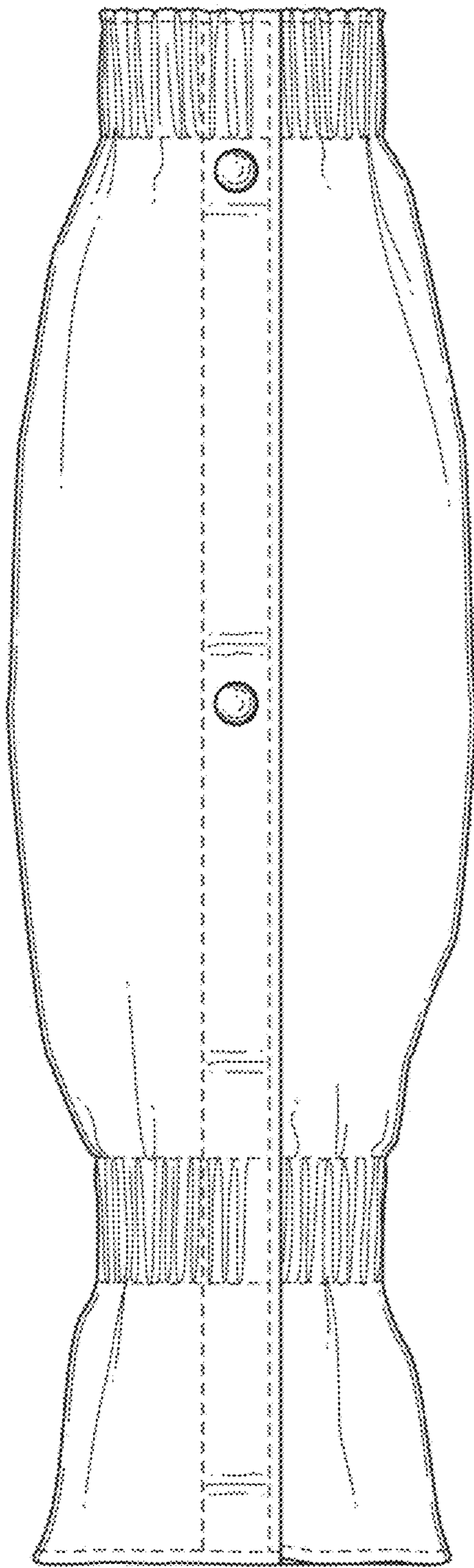

FIG. 4

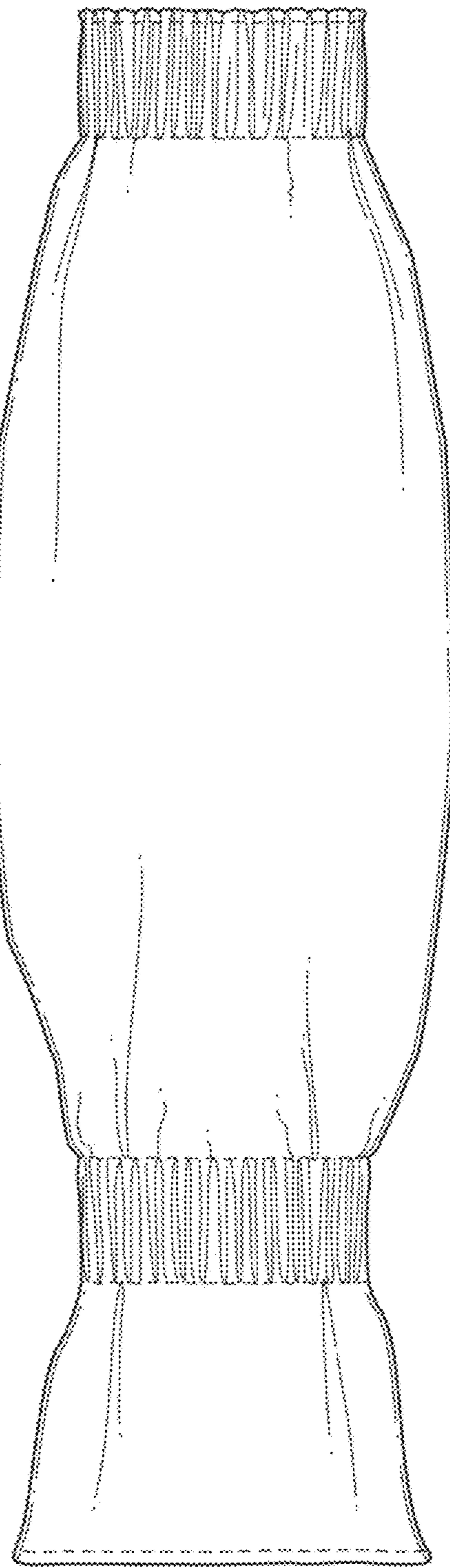

FIG. 5

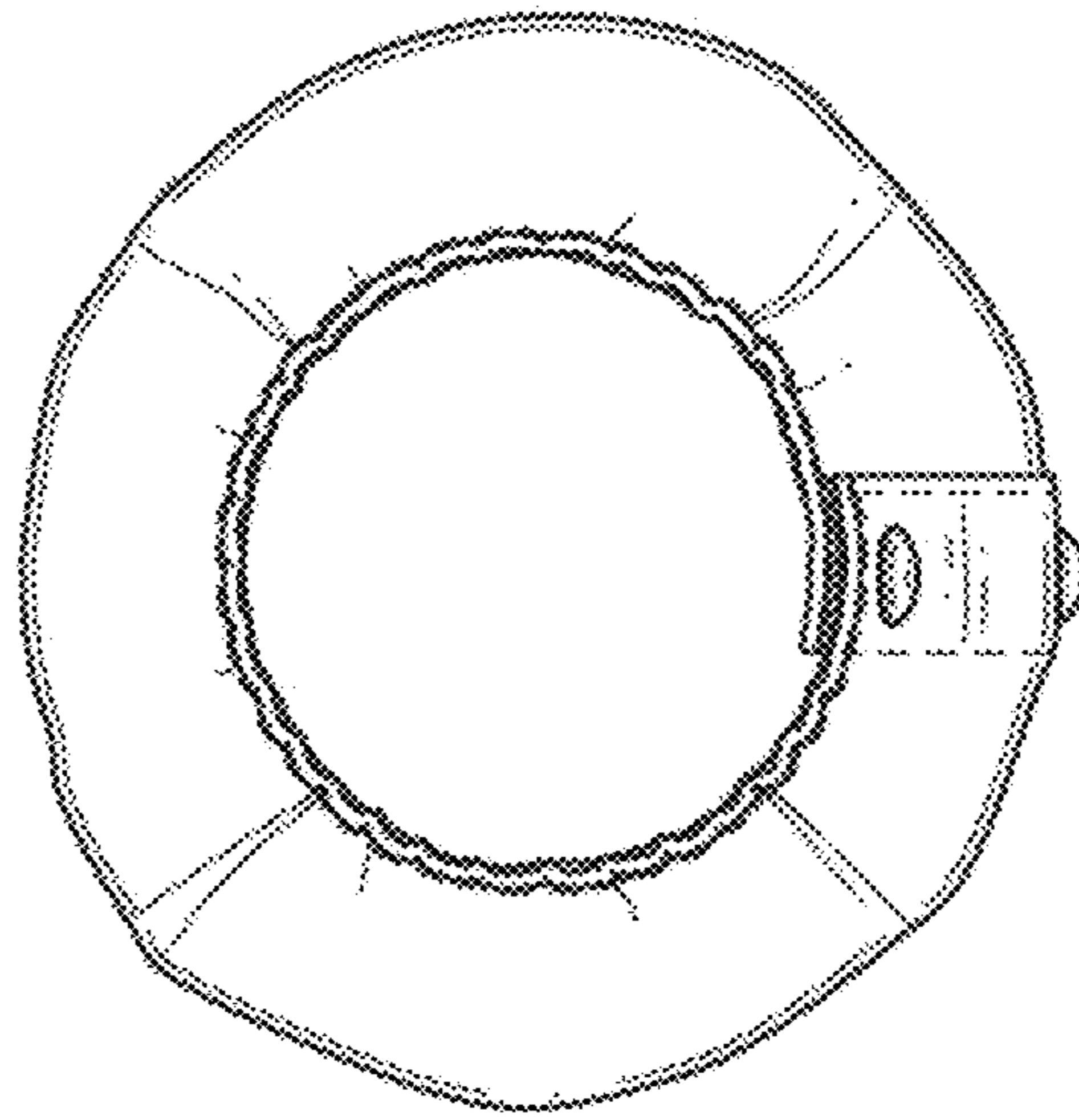

FIG. 6

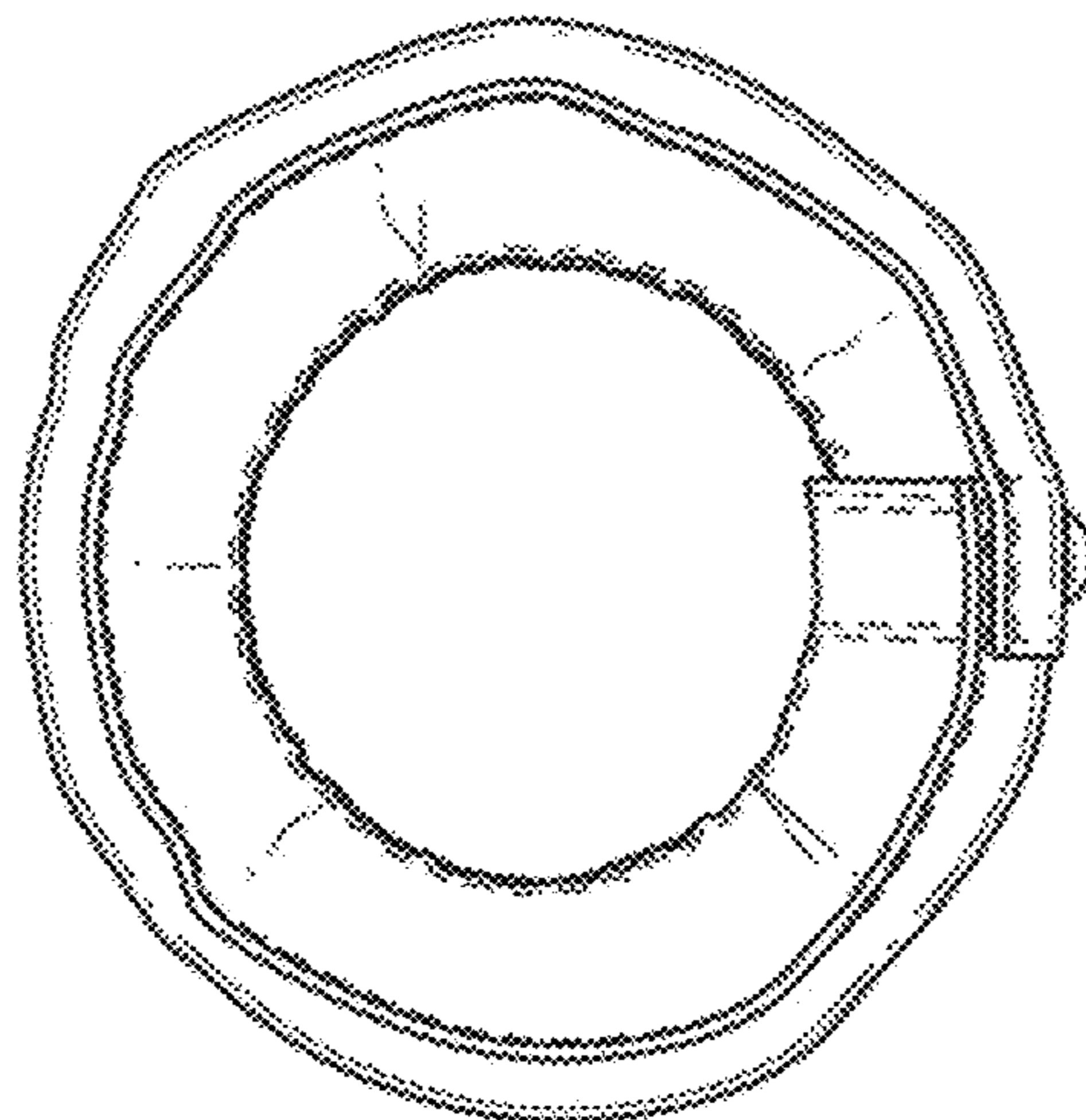

FIG. 7