



US00D818197S

(12) **United States Design Patent** (10) **Patent No.:** **US D818,197 S**
Szymanski et al. (45) **Date of Patent:** **** May 15, 2018**

(54) **SHAVING DEVICE**
(71) Applicants: **Aaron Szymanski**, Thomaston, CT
(US); **Anand Khubani**, Towaco, NJ
(US)
(72) Inventors: **Aaron Szymanski**, Thomaston, CT
(US); **Anand Khubani**, Towaco, NJ
(US)
(73) Assignee: **IdeaVillage Products Corporation**,
Wayne, NJ (US)

D397,512 S * 8/1998 Gray D28/48
D406,393 S * 3/1999 Gray D28/48
D438,342 S * 2/2001 Gray D28/48
D444,267 S * 6/2001 Gray D28/48
D500,174 S * 12/2004 Gray D28/48
D515,740 S * 2/2006 Provost D28/46
D629,565 S * 12/2010 Kling D28/48
D636,531 S * 4/2011 Wilson D28/46
D797,372 S * 9/2017 Forti D28/46
D797,376 S * 9/2017 Forti D28/46
2015/0174776 A1* 6/2015 Hawes B26B 21/14
30/526

(**) Term: **15 Years**

* cited by examiner

Primary Examiner — Jennifer Rivard

(21) Appl. No.: **29/620,448**

(74) *Attorney, Agent, or Firm* — Dan DeLaRosa

(22) Filed: **Dec. 20, 2016**

(57) **CLAIM**

(51) **LOC (11) Cl.** **28-03**

The ornamental design for a shaving device, as shown and described.

(52) **U.S. Cl.**

USPC **D28/46**

(58) **Field of Classification Search**

USPC D28/46-48

CPC B26B 21/08-21/32; B26B 21/34-21/38;

B26B 21/446; B26B 21/52-21/4062;

B26B 21/4068-21/4075

See application file for complete search history.

DESCRIPTION

FIG. 1 is a front perspective view of a shaving device of the present invention showing my new design; FIG. 2 is a front side elevation view thereof; FIG. 3 is a back side elevation view thereof; FIG. 4 is a side elevation view thereof; FIG. 5 is another side elevation view thereof; FIG. 6 is a top plan view thereof; and, FIG. 7 is a bottom plan view thereof. The broken lines illustrate portions of the shaving device and form no part of the claimed design.

(56) **References Cited**

U.S. PATENT DOCUMENTS

D306,496 S * 3/1990 Newberry, Jr. D28/45
D310,271 S * 8/1990 Jacobson D28/46
D311,784 S * 10/1990 Schwartz D28/48
D392,418 S * 3/1998 Gray D28/48
D396,129 S * 7/1998 Gray D28/46

1 Claim, 7 Drawing Sheets

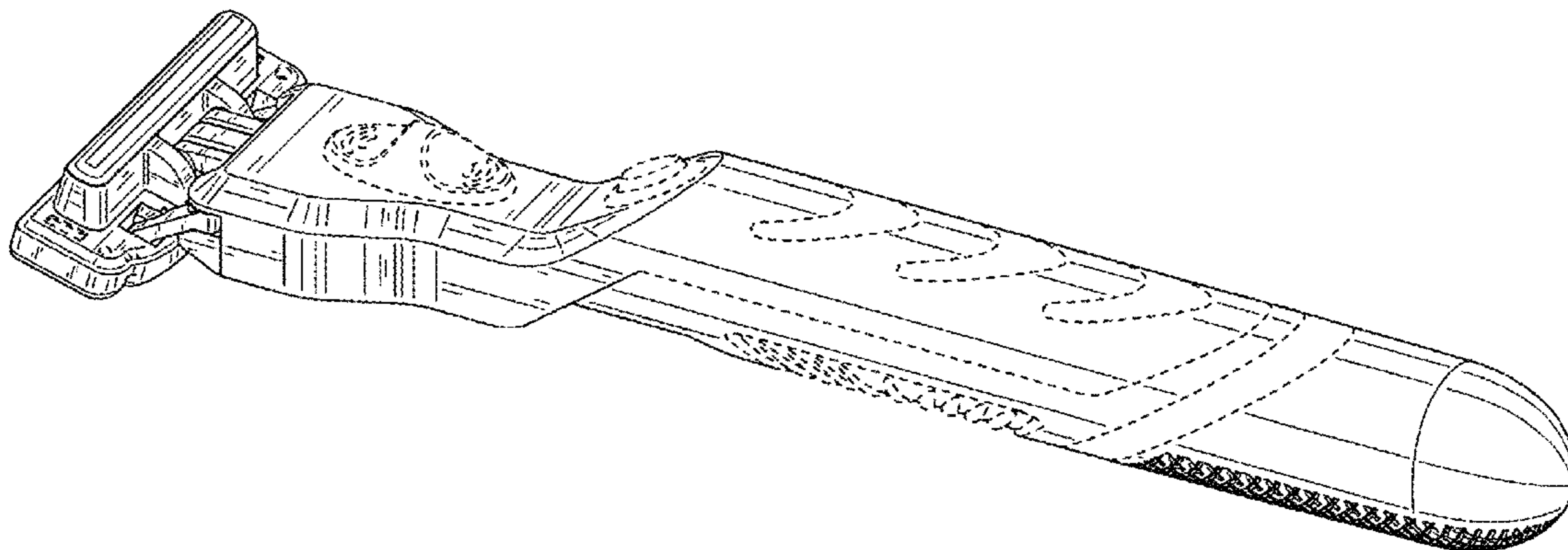

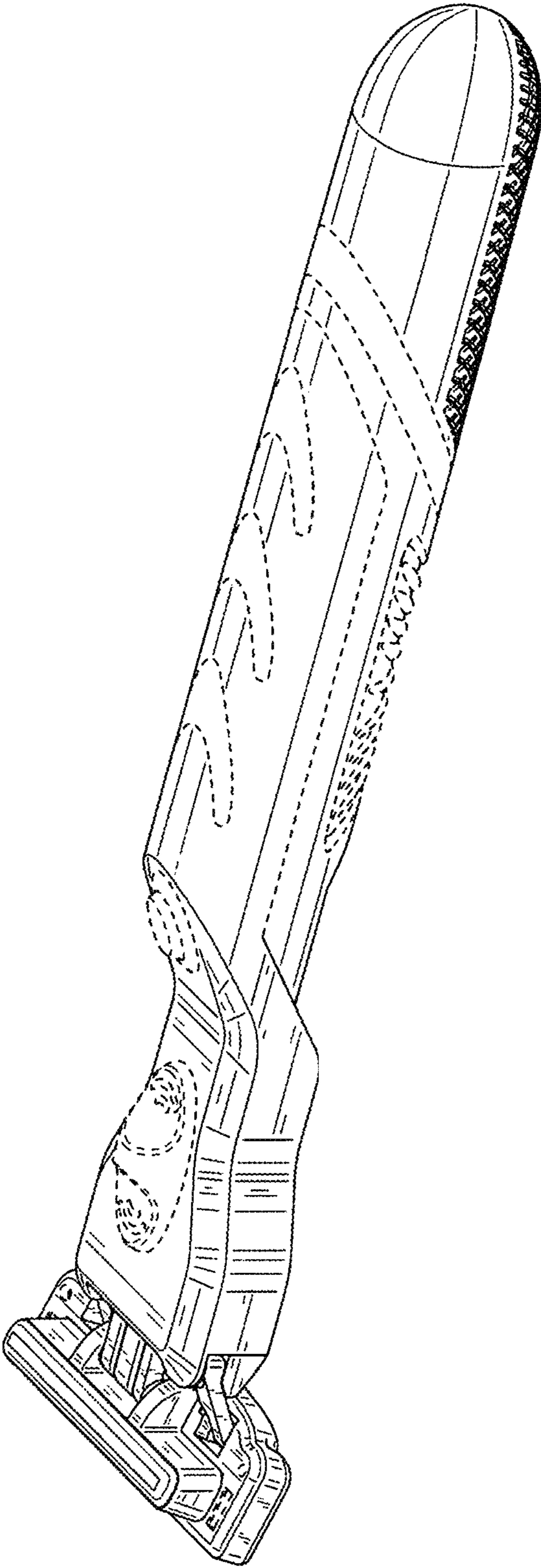

FIG. 1

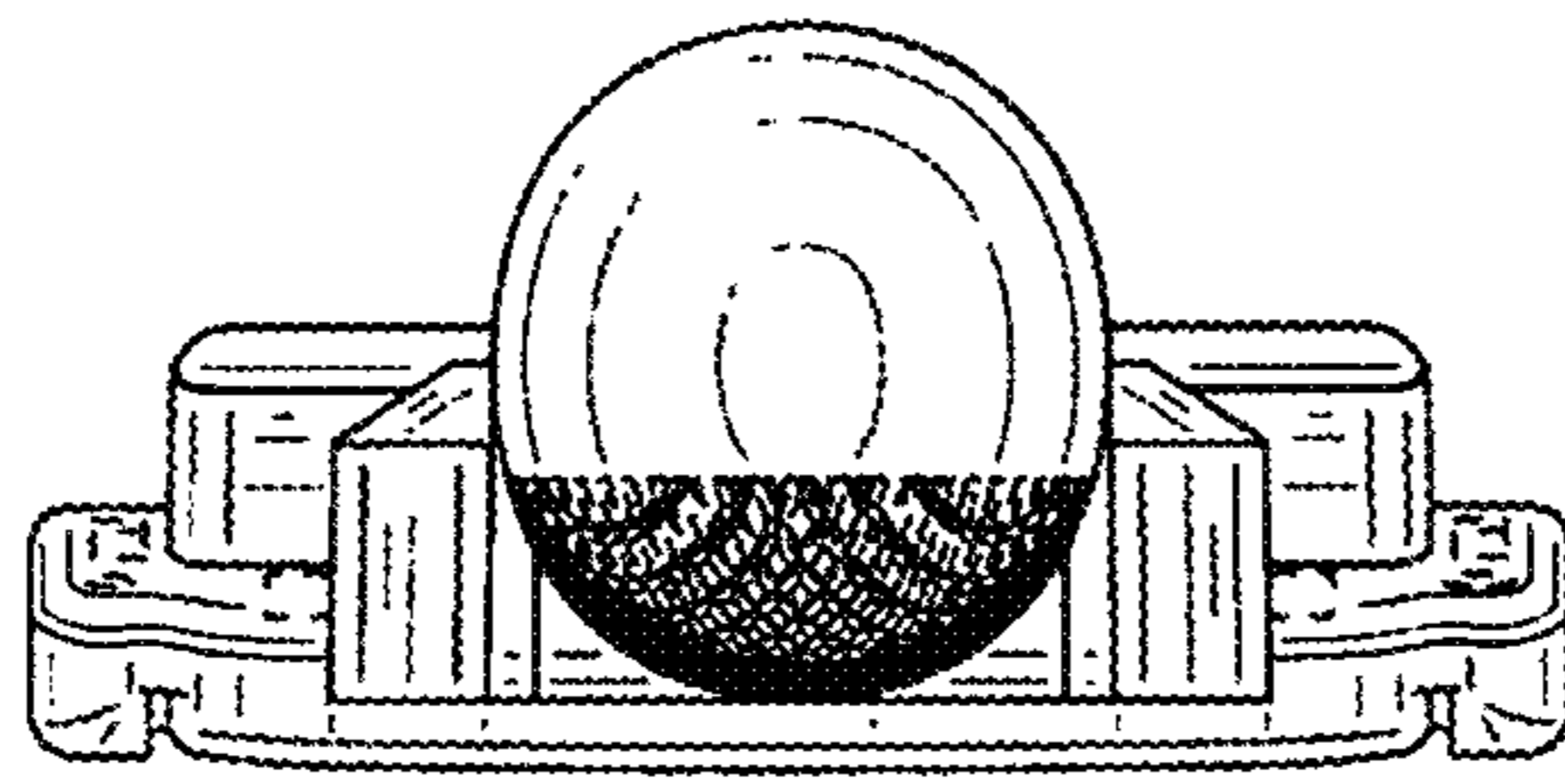

FIG. 2

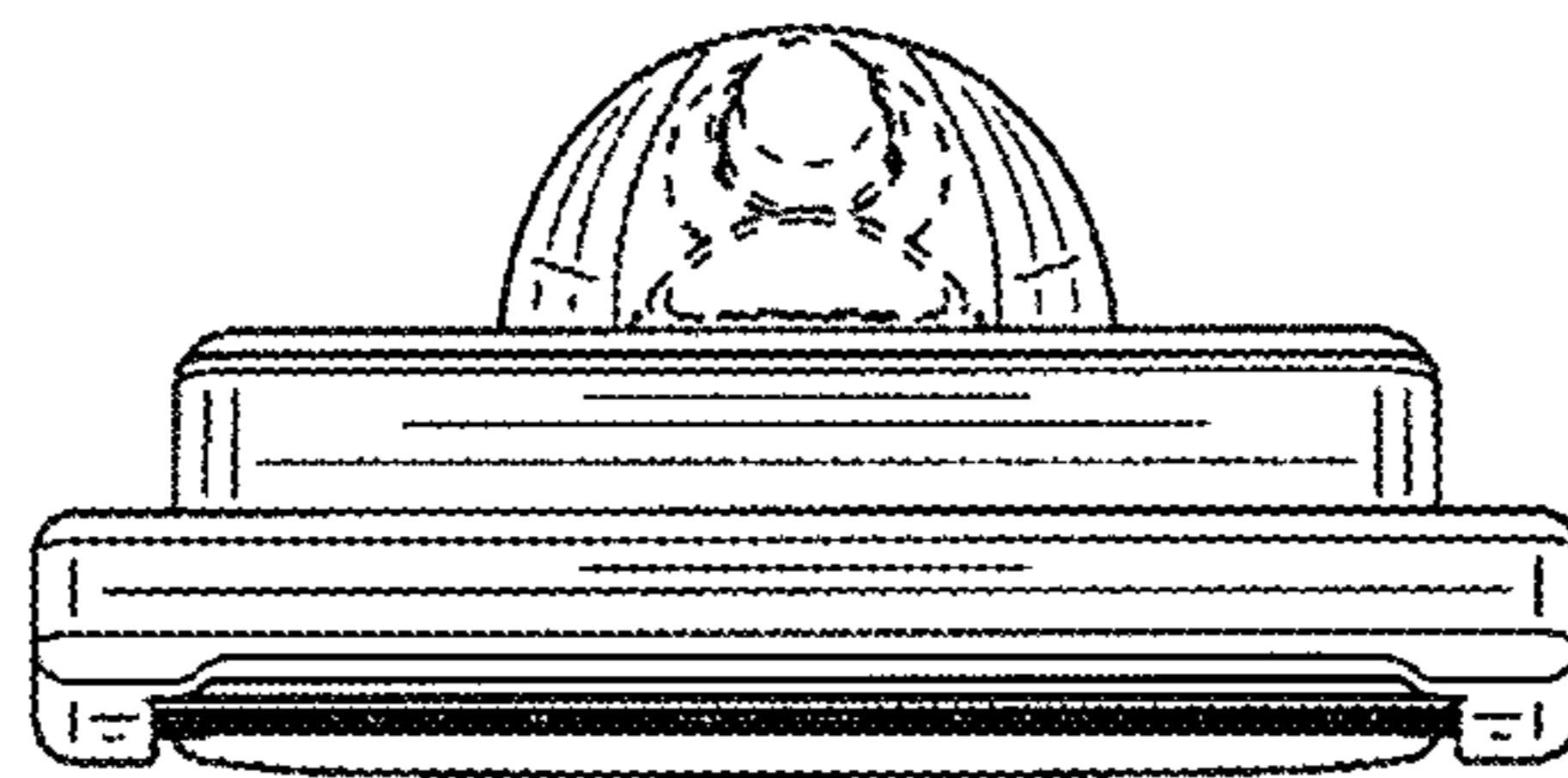

FIG. 3

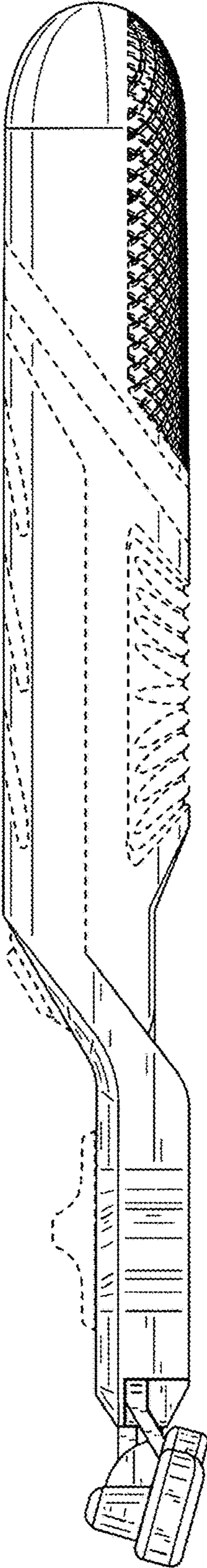

FIG. 4

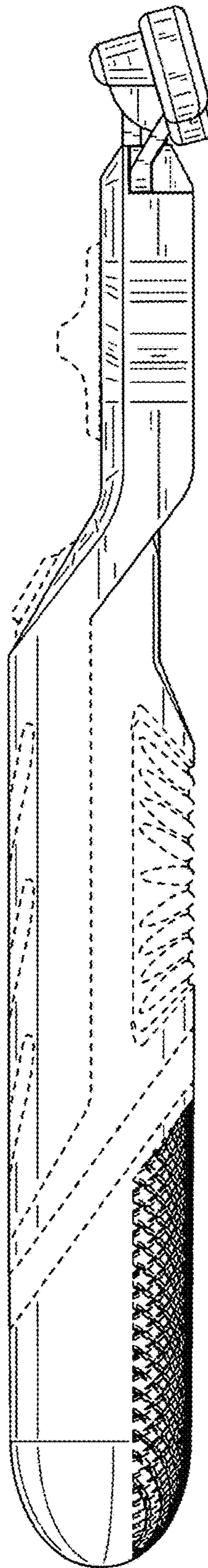

FIG. 5

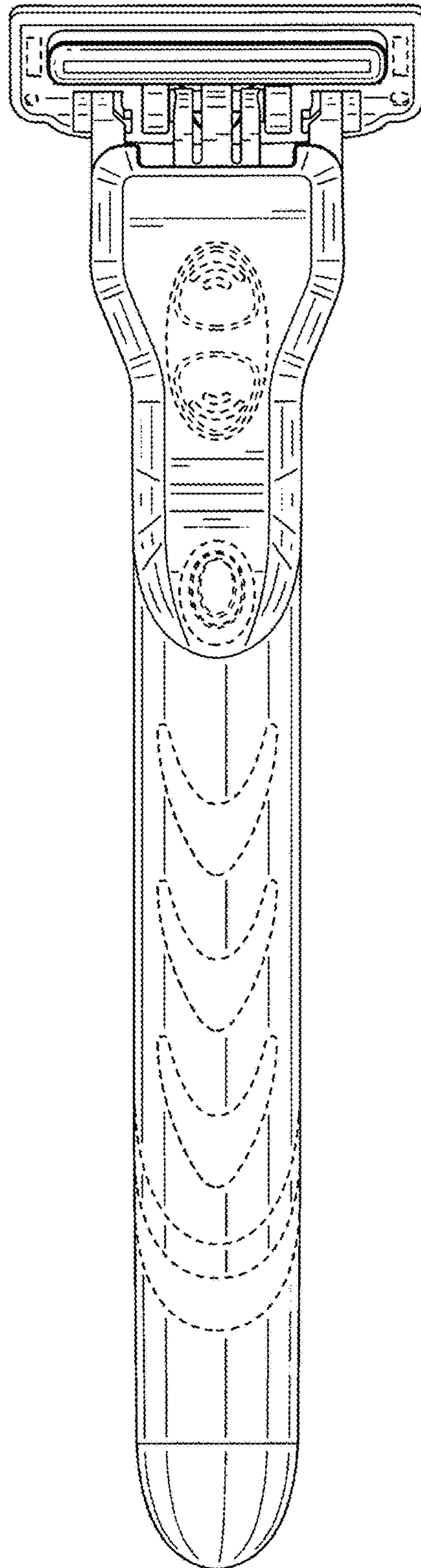

FIG. 6

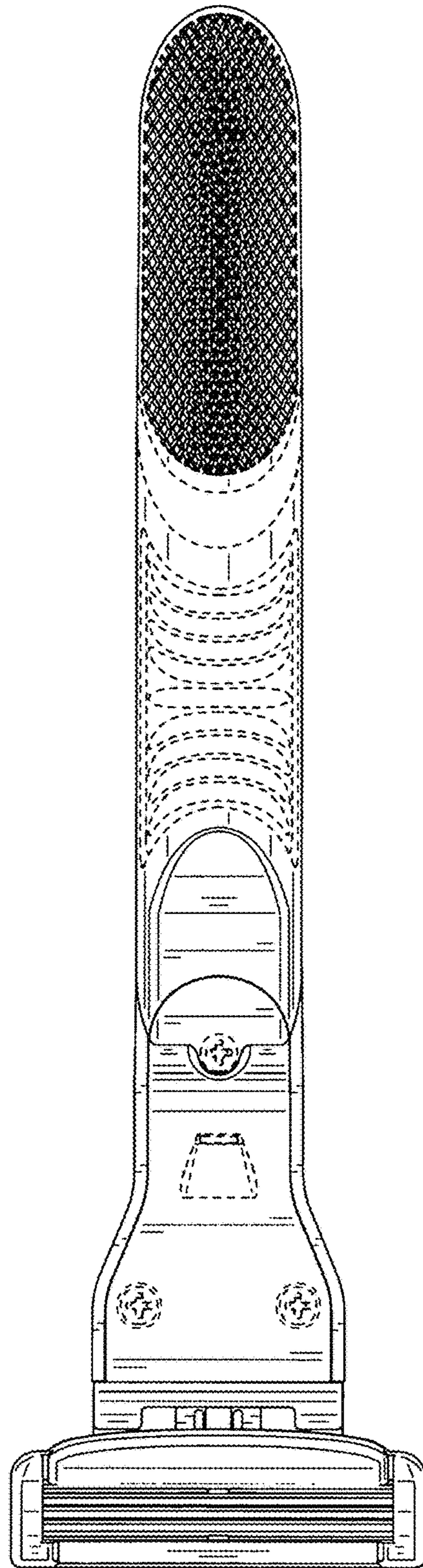

FIG. 7