



US00D818179S

(12) **United States Design Patent** (10) **Patent No.:** **US D818,179 S**  
**Amato et al.** (45) **Date of Patent:** **\*\* May 15, 2018**

- (54) **LIGHTING FIXTURE**
- (71) Applicant: **The Urban Electric Company**, North Charleston, SC (US)
- (72) Inventors: **Michael Amato**, Johns Island, SC (US); **David Dawson**, Charleston, SC (US); **Jonathan Charpia**, Summerville, SC (US); **Christopher Roof**, Charleston, SC (US); **Joeangel Casanova**, North Charleston, SC (US); **Courteney Salsbury**, Mount Pleasant, SC (US); **Brianna Magagnoli**, Charleston, SC (US)
- (73) Assignee: **The Urban Electric Company**, North Charleston, SC (US)
- (\*\*) Term: **15 Years**
- (21) Appl. No.: **29/598,819**
- (22) Filed: **Mar. 29, 2017**
- (51) **LOC (11) Cl.** ..... **26-03**
- (52) **U.S. Cl.**  
USPC ..... **D26/88**
- (58) **Field of Classification Search**  
USPC ..... D26/72, 84, 85, 87, 88, 92, 107, 118, D26/129, 132, 134, 136  
CPC ..... F21S 8/03; F21S 8/031; F21S 8/04; F21S 8/06; F21S 8/061; F21S 8/063; F21S 8/065  
See application file for complete search history.

- 3,258,239 A \* 6/1966 Green ..... F21S 8/061 248/342
- D230,186 S \* 1/1974 Reinmuth ..... D26/85
- D343,471 S \* 1/1994 Belisle ..... D26/85
- D400,287 S \* 10/1998 Littman ..... D26/88
- D492,440 S \* 6/2004 Parres ..... D26/85
- D594,150 S \* 6/2009 Sabernig ..... D26/128
- D596,335 S \* 7/2009 Sabernig ..... D26/88
- D603,552 S \* 11/2009 Kampe ..... D26/88
- D663,470 S \* 7/2012 Ruiz ..... D26/88
- D664,281 S \* 7/2012 Ayliffe ..... D26/88
- D674,530 S \* 1/2013 Wanders ..... D26/88

**OTHER PUBLICATIONS**

“The Buggy Blog” entry Oct. 24, 2014, advertising the Colleen & Company Lighting Sale at One Kings Lane, scalloped gold fixture, center left in photo. Found at [blog.buggydesign.com](http://blog.buggydesign.com). (Year: 2014).\*  
(Continued)

*Primary Examiner* — Clare E Heflin  
(74) *Attorney, Agent, or Firm* — Jeffrey T. Stover; Haynsworth Sinkler Boyd, P.A.

(57) **CLAIM**

The ornamental design for a lighting fixture, as shown and described.

**DESCRIPTION**

FIG. 1 is a bottom perspective view of a new lighting fixture; FIG. 2 is a top perspective view thereof; FIG. 3 is a front elevation view thereof; FIG. 4 is a back elevation view thereof; FIG. 5 is a left side elevation view thereof; FIG. 6 is a right side elevation view thereof; FIG. 7 is a top plan view thereof; and, FIG. 8 is a bottom plan view thereof.  
The broken line disclosure in the views represents environmental structure which forms no part of the claimed design.

**1 Claim, 8 Drawing Sheets**

- (56) **References Cited**  
U.S. PATENT DOCUMENTS  
D87,935 S \* 10/1932 Muench ..... D26/88  
D185,874 S \* 8/1959 Rambusch ..... D26/88

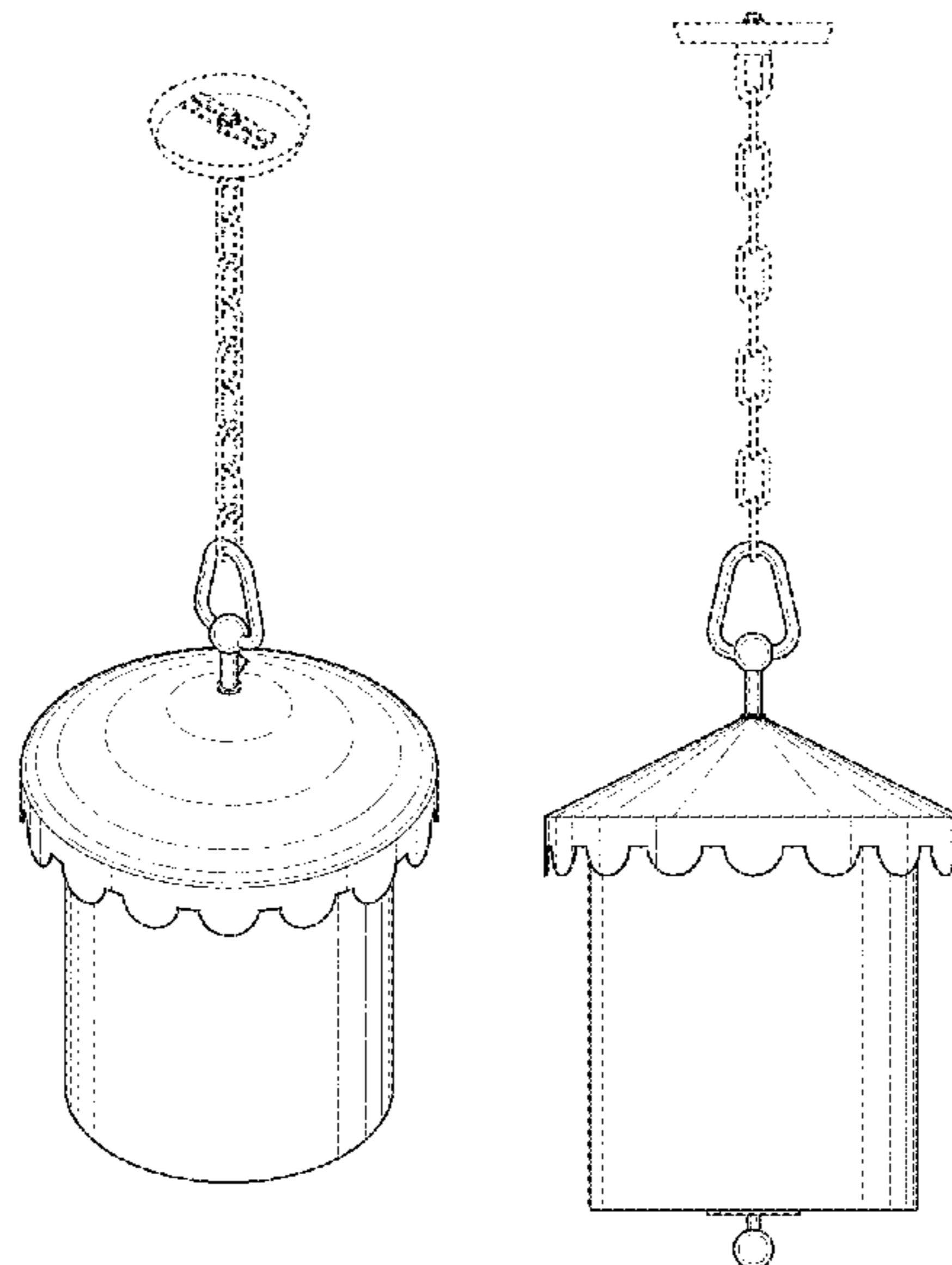

(56)

**References Cited**

OTHER PUBLICATIONS

Scalloped White Metal Flushmount light fixture from Pottery Barn Kids. Found at potterybarnkids.com visited Mar. 19, 2018. (Year: 2018).\*

Little Girl Hanging Lantern from Stray Dog Designs. Found at straydogdesigns.com visited Mar. 19, 2018. (Year: 2018).\*

\* cited by examiner

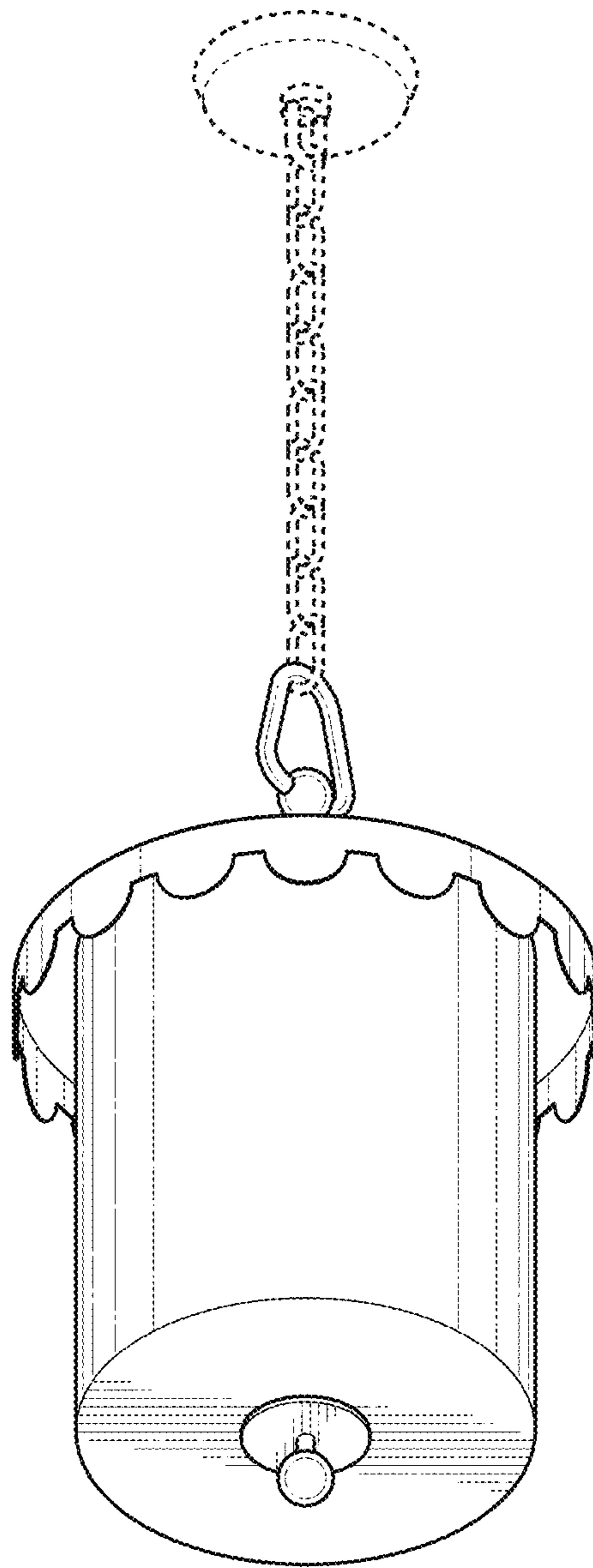

FIG. 1

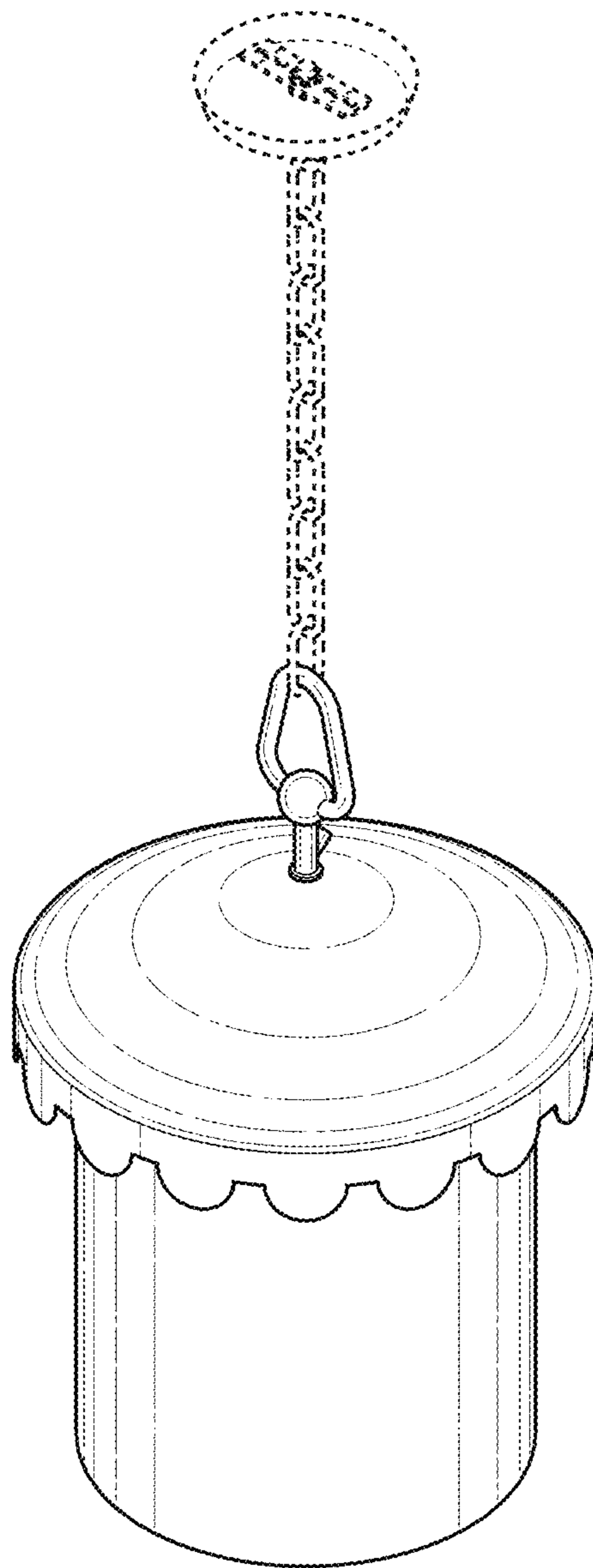

FIG. 2

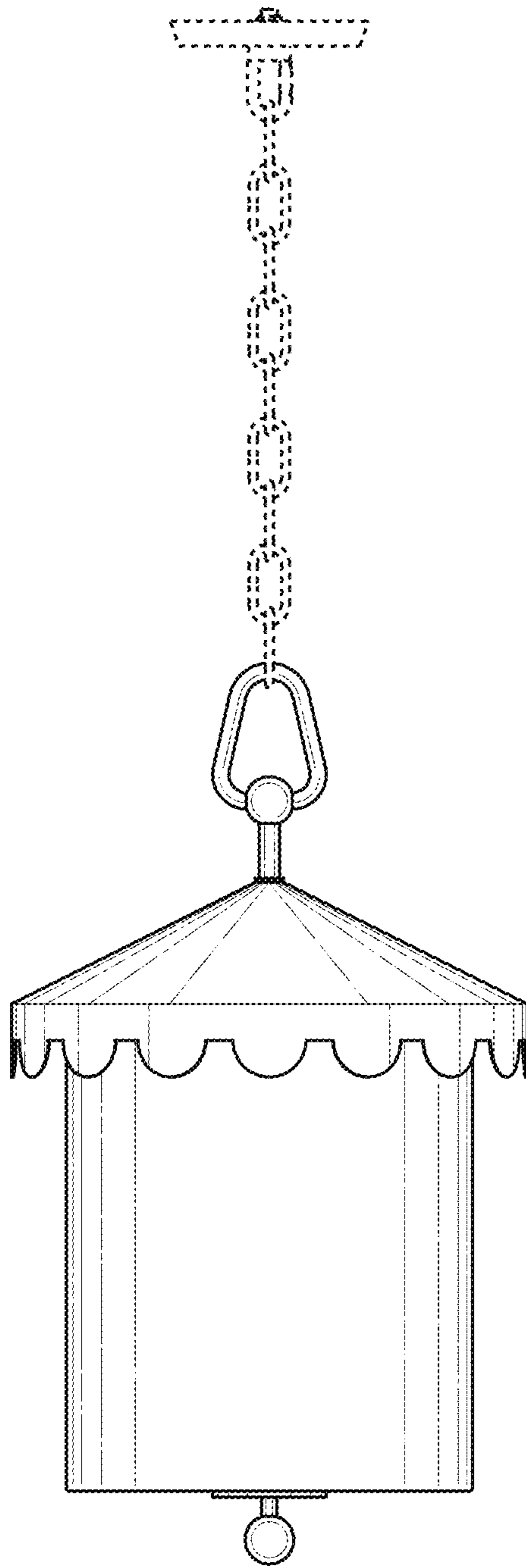

FIG. 3

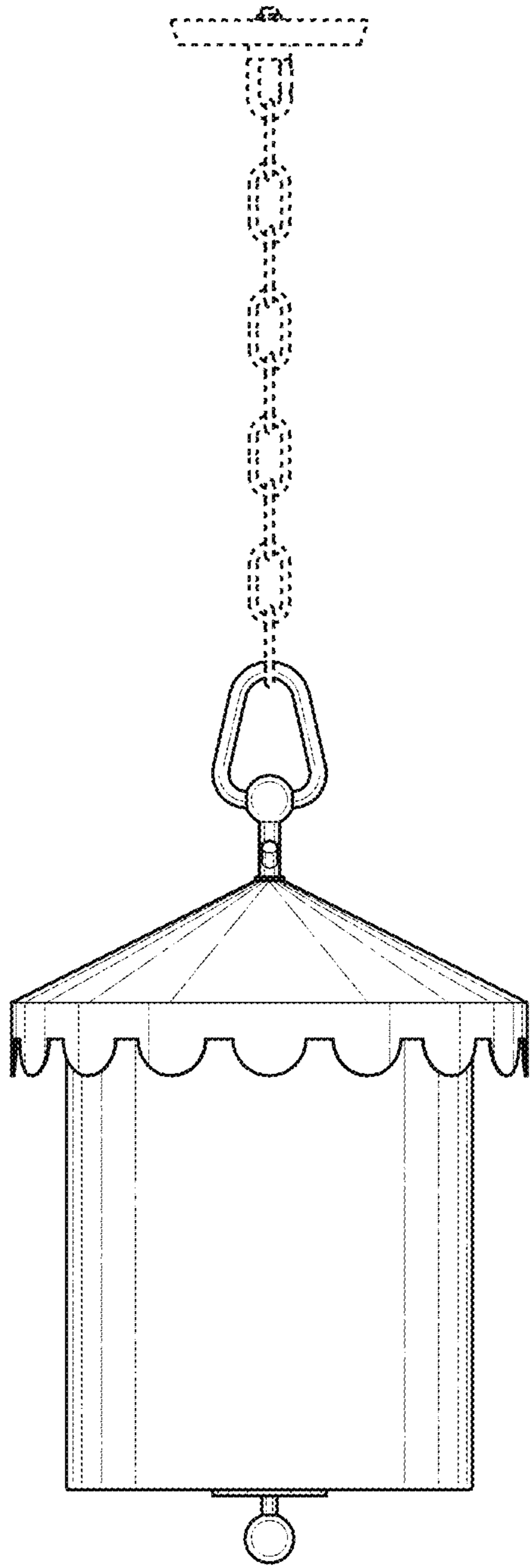

FIG. 4

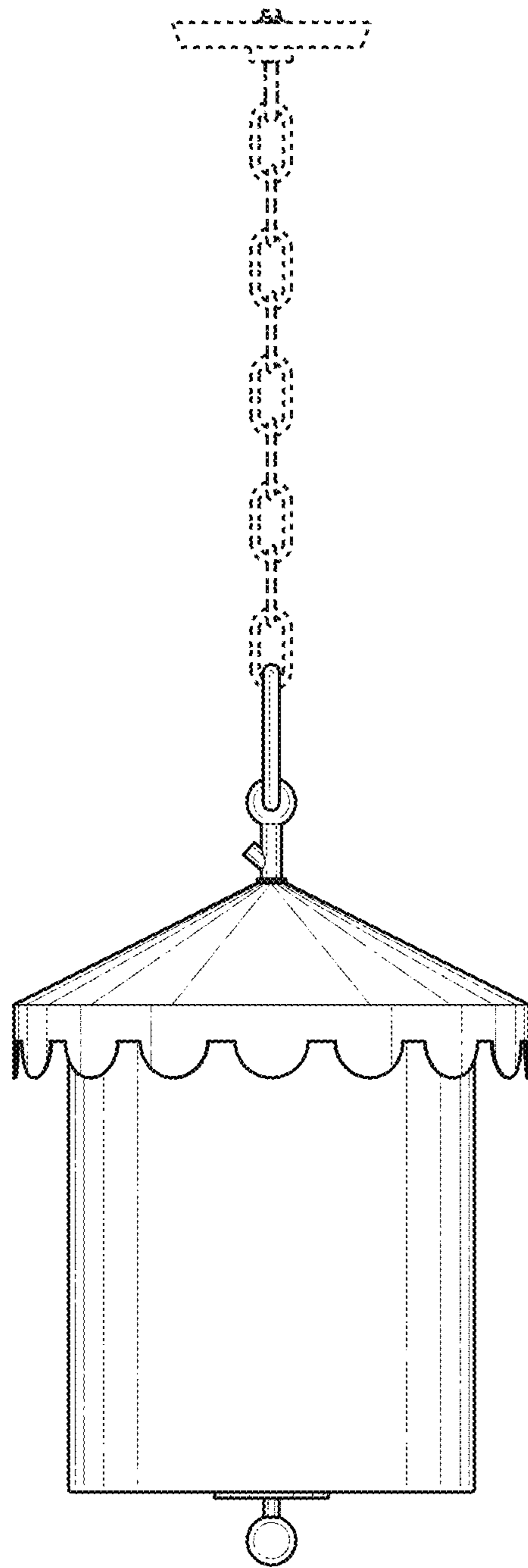

FIG. 5

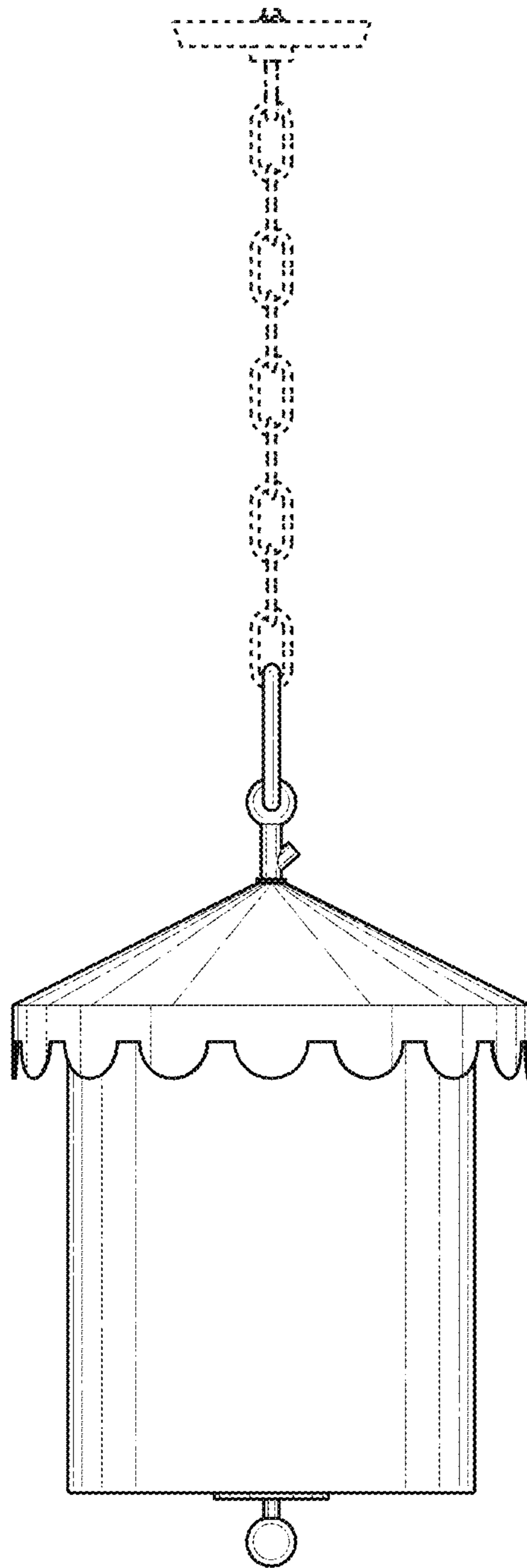

FIG. 6



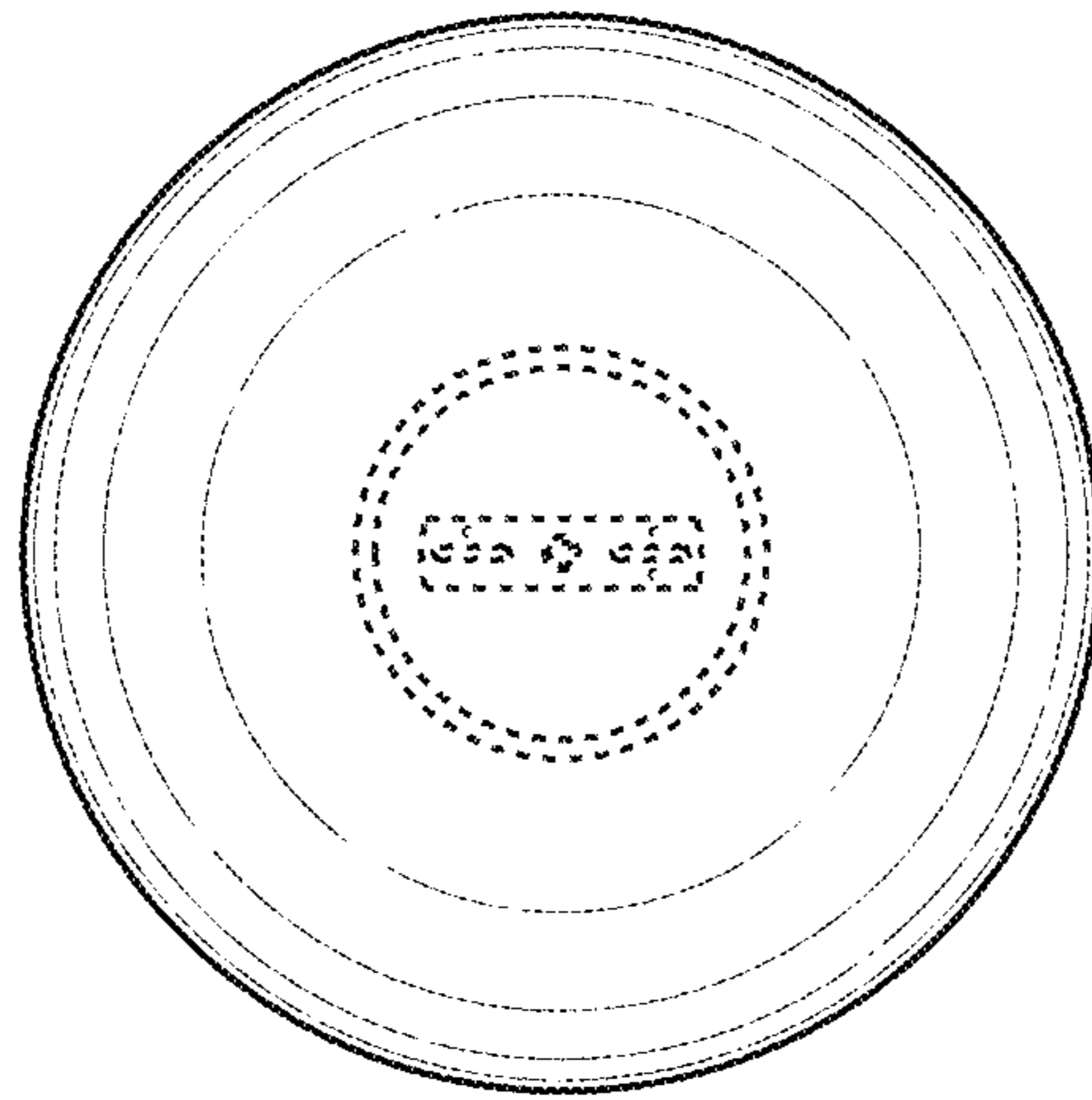
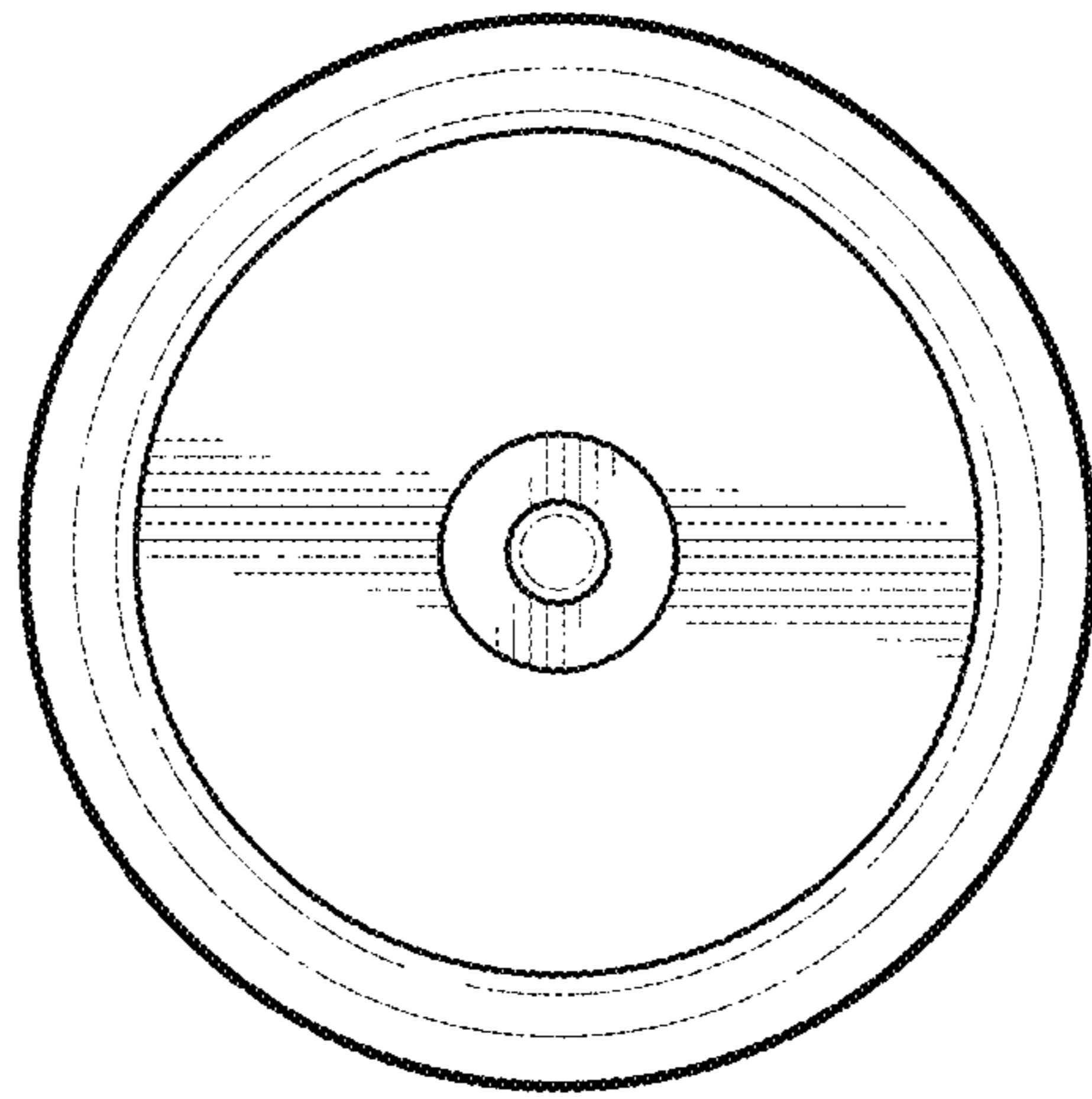

FIG. 7



**FIG. 8**