



US00D818138S

(12) **United States Design Patent** (10) **Patent No.:** **US D818,138 S**
Nicosia (45) **Date of Patent:** **** May 15, 2018**

- (54) **KNEE WARMER**
- (71) Applicant: **Charles Nicosia**, Pleasantville, NY
(US)
- (72) Inventor: **Charles Nicosia**, Pleasantville, NY
(US)
- (**) Term: **15 Years**
- (21) Appl. No.: **29/636,674**
- (22) Filed: **Feb. 9, 2018**
- (51) **LOC (11) Cl.** **24-04**
- (52) **U.S. Cl.**
USPC **D24/206**
- (58) **Field of Classification Search**
USPC D24/206–208, 190; D29/121.1
CPC A61F 7/02; A61F 7/03; A61F 7/034; A61F
7/106; A61F 2007/0001; A61F
2007/0042; A61F 2007/0228; A61F
2007/0231; A41D 13/05; A41D 13/065
See application file for complete search history.

(56) **References Cited**

U.S. PATENT DOCUMENTS

- D255,728 S * 7/1980 Baron D24/190
D311,791 S * 10/1990 Koldofsky D29/121.1
D351,255 S * 10/1994 Pytlewski D29/121.1
5,398,667 A * 3/1995 Witt A61F 7/03
126/204
D385,670 S 10/1997 Oetting

- 5,873,903 A * 2/1999 Garcia A61F 7/02
2/912
D440,017 S * 4/2001 Pagotto D29/121.1
D510,626 S * 10/2005 Krahner D24/206

* cited by examiner

Primary Examiner — Wan Laymon

(74) *Attorney, Agent, or Firm* — Andrew F. Young, Esq.;
Lackenbach Siegel, LLP

(57) **CLAIM**

The ornamental design for a knee warmer, as shown and described.

DESCRIPTION

FIG. 1 is a left front perspective view of my present invention.
FIG. 2 is a front elevation view thereof.
FIG. 3 is a rear elevation view thereof.
FIG. 4 is a left side elevation view thereof.
FIG. 5 is a right side elevation view thereof.
FIG. 6 is a top plan view thereof.
FIG. 7 is a bottom plan view thereof; and,
FIG. 8 is a front left perspective view thereof in an use position.

No claim is made to portions that are not shown. The dash-dash broken lines showing in the figures are included for the purpose of illustrating environmental structure of the knee warmer and form no part of the claimed design. The dash-dot-dot-dash lines on the interior of the knee warmer indicate boundary lines and no claim is made therein. The surfaces are lined for contour.

1 Claim, 8 Drawing Sheets

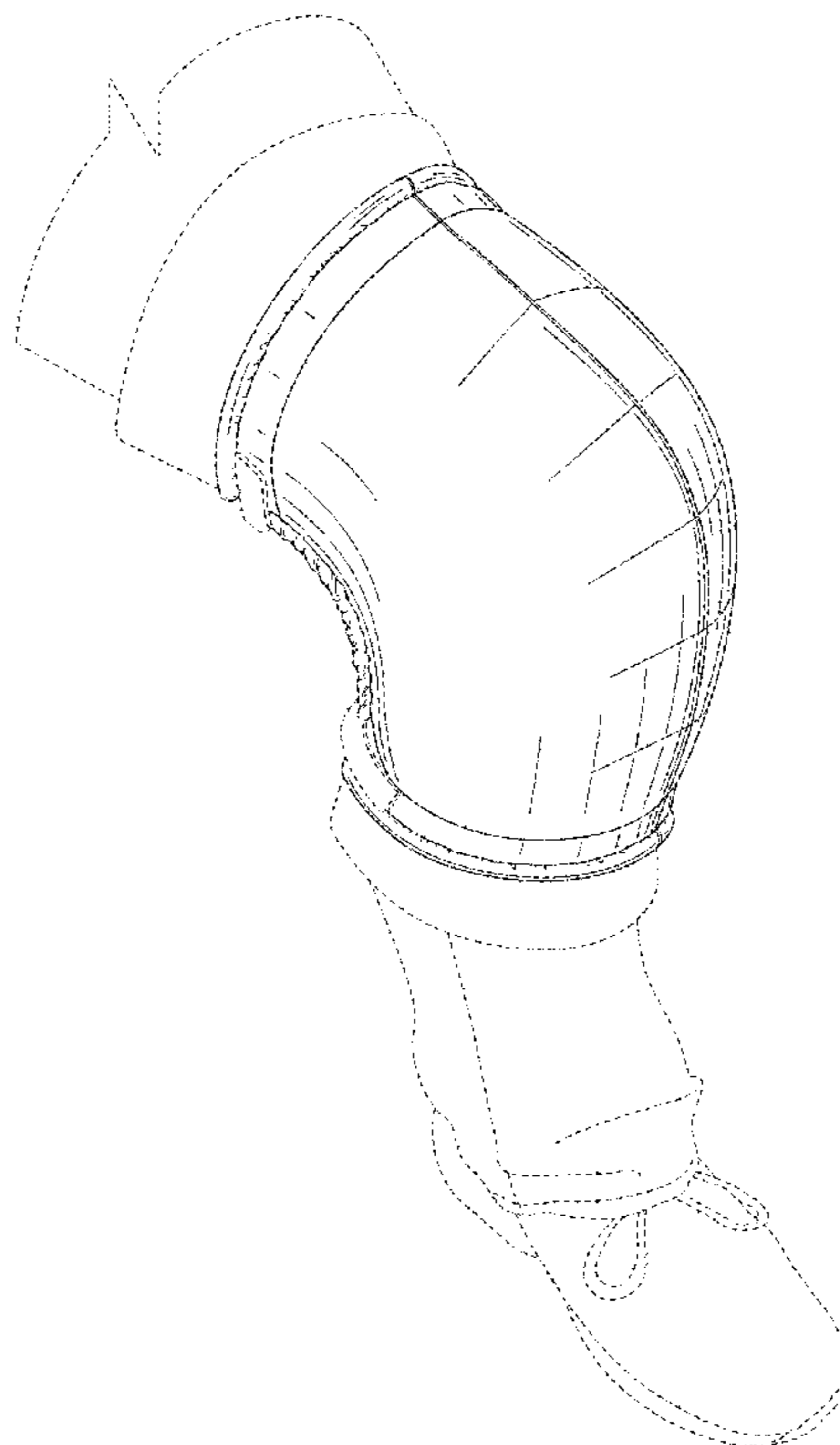

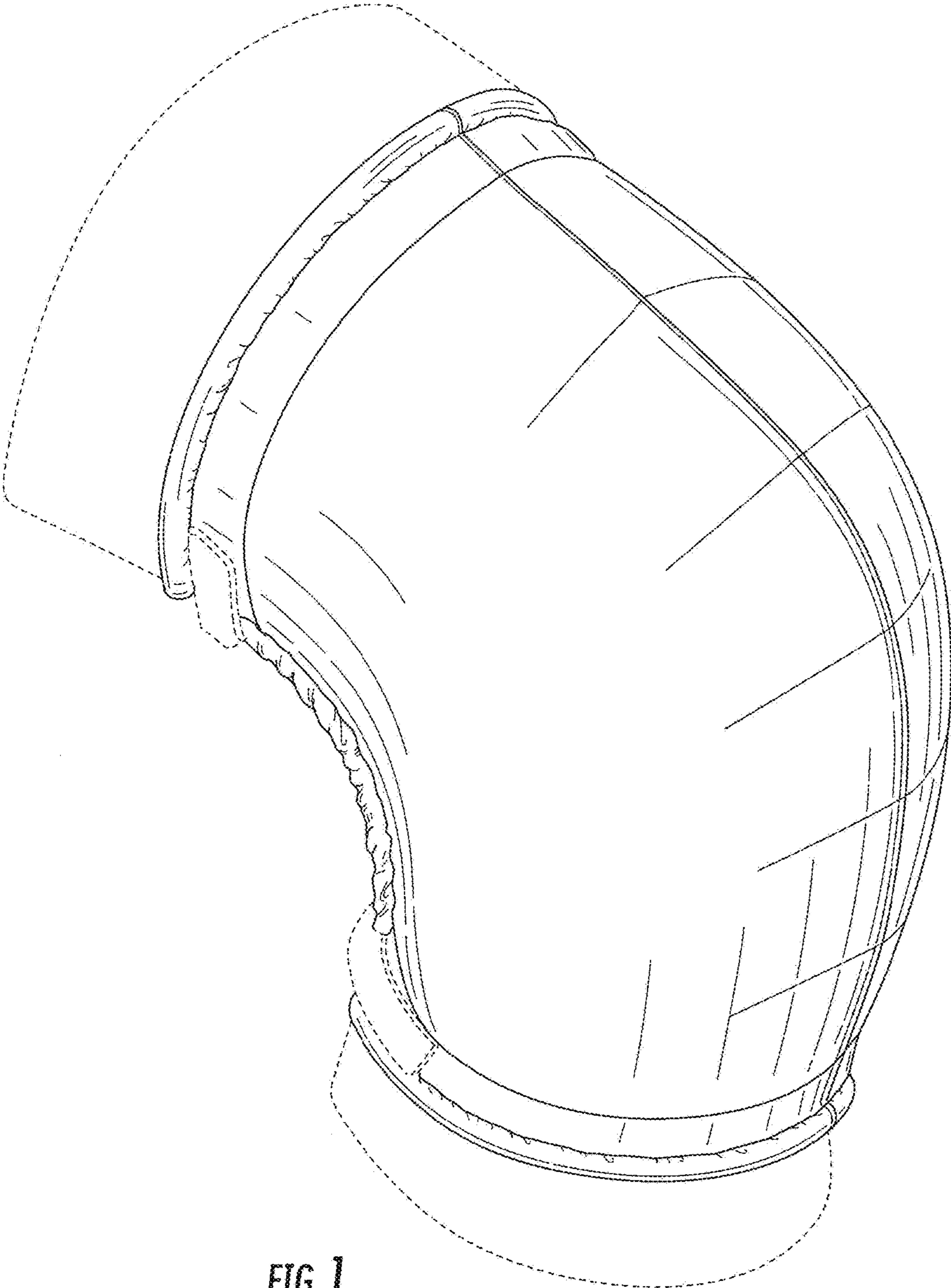

FIG. 1

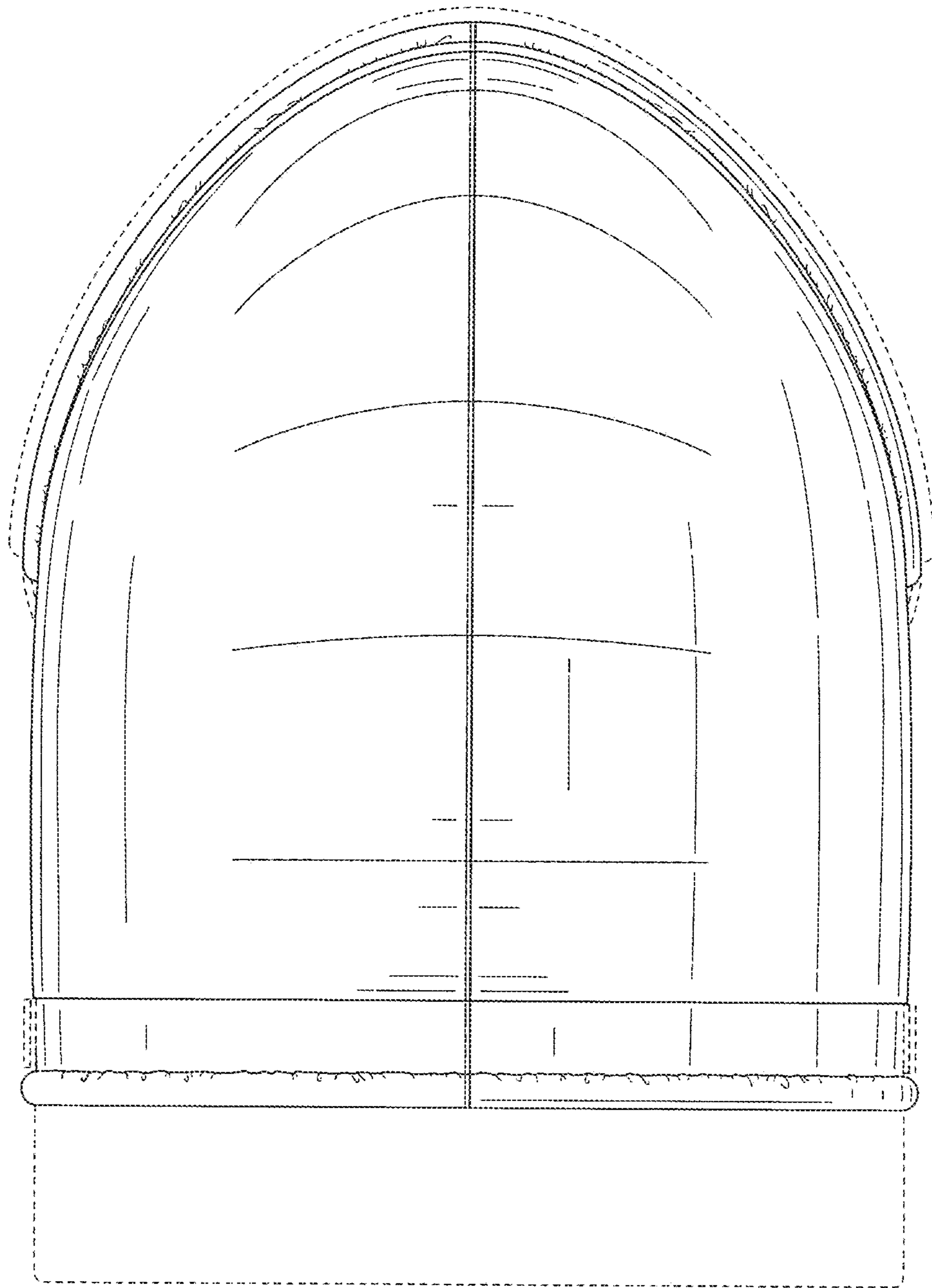

FIG. 2

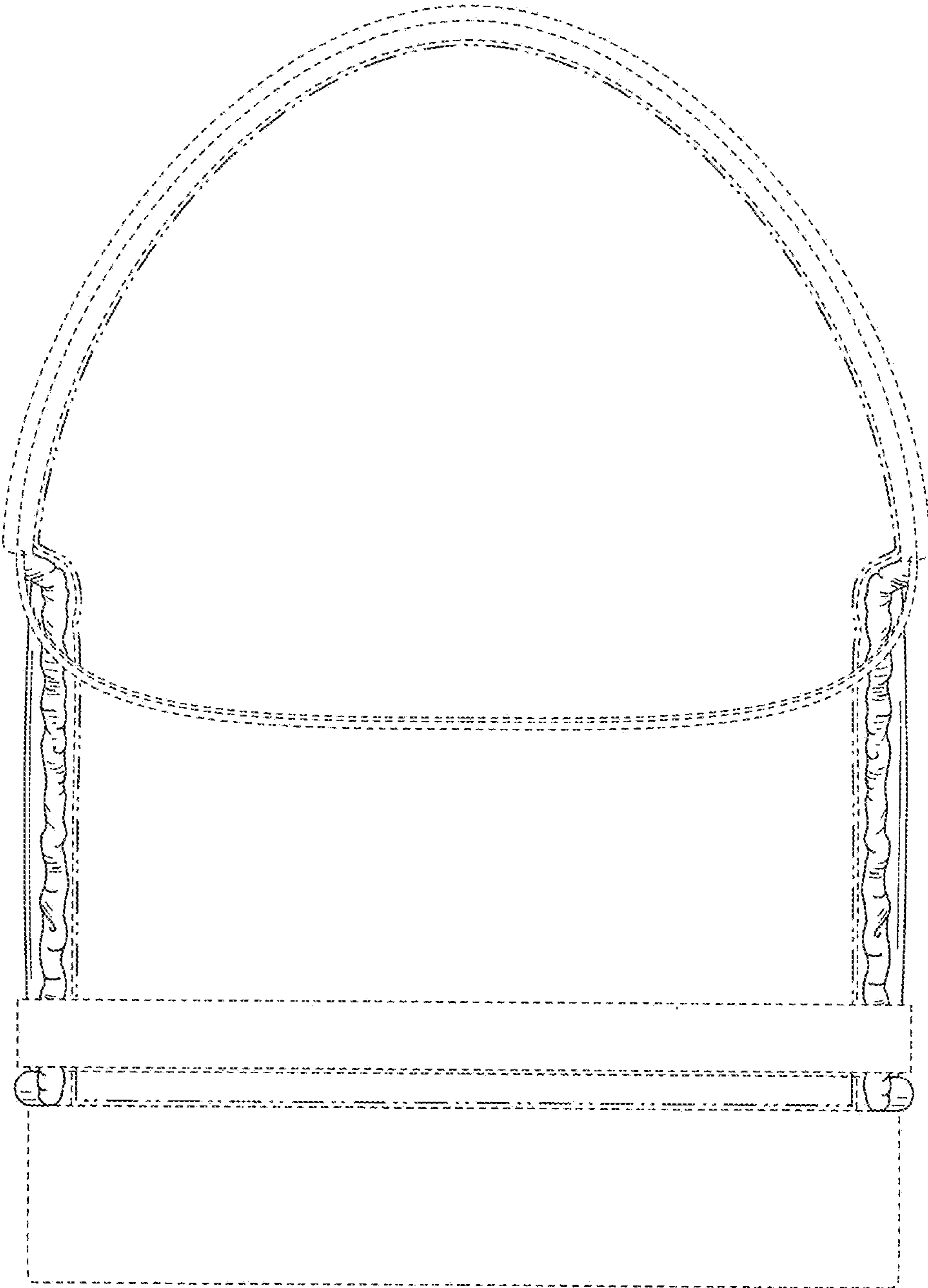

FIG. 3

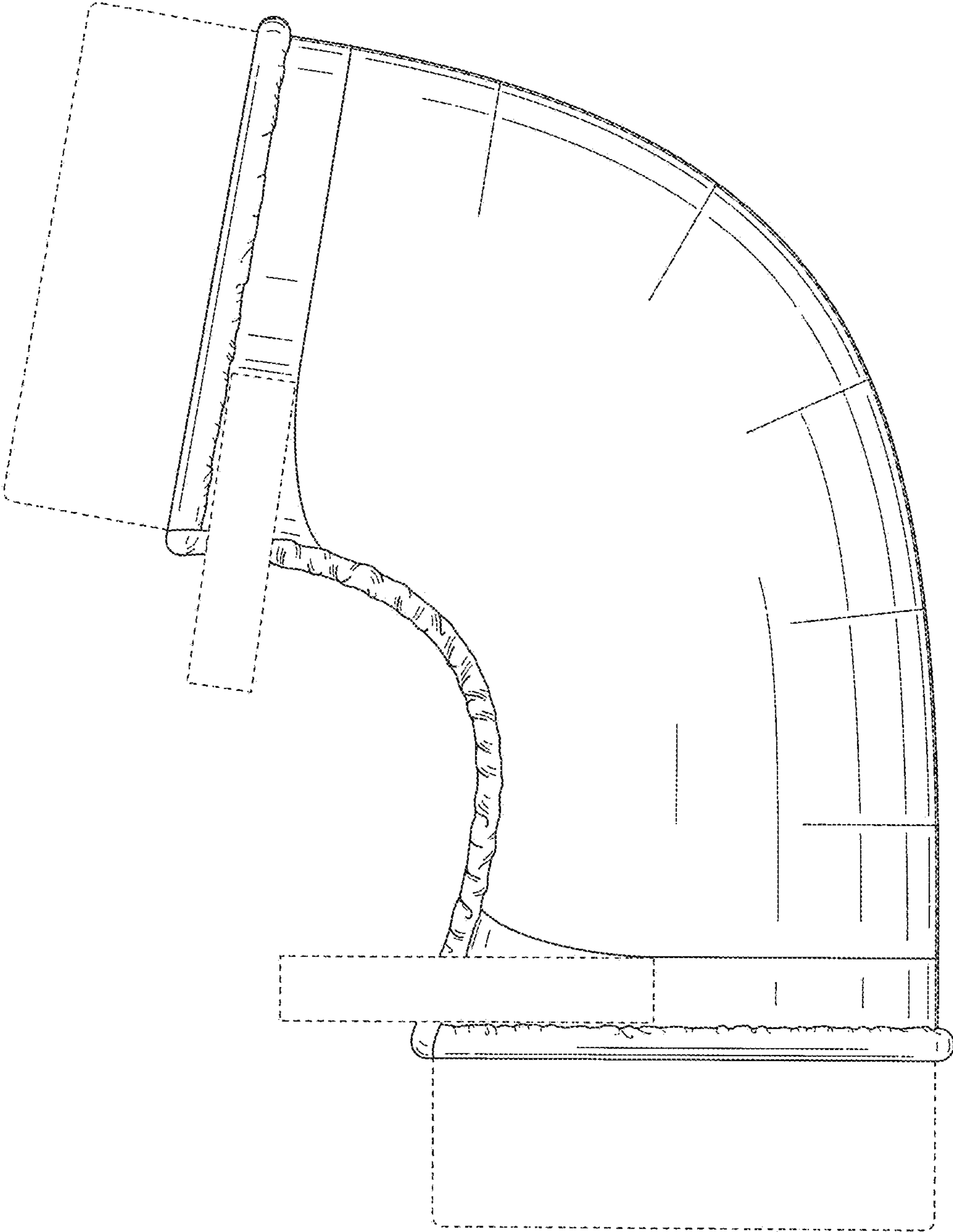

FIG. 4

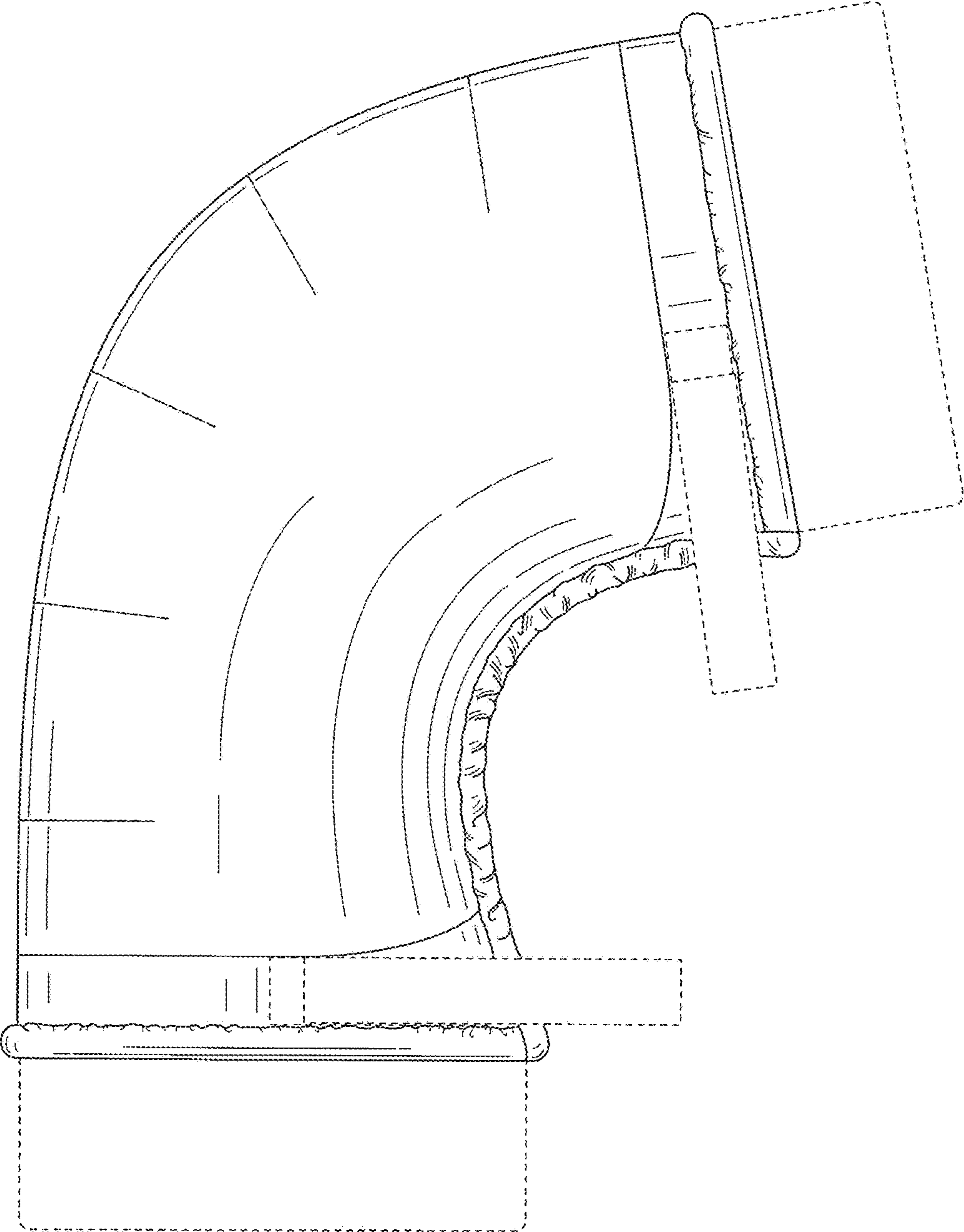

FIG. 5

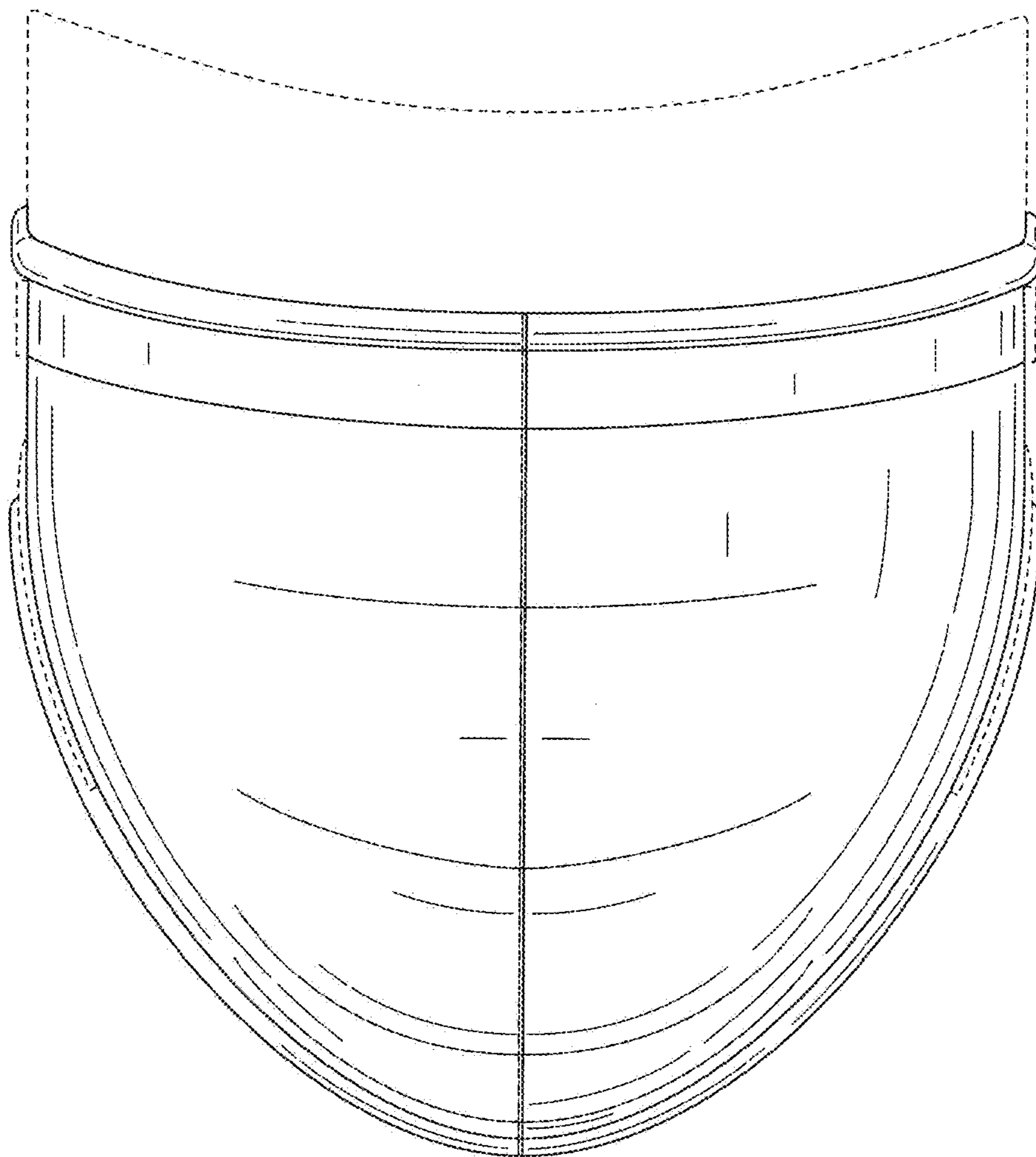

FIG. 6

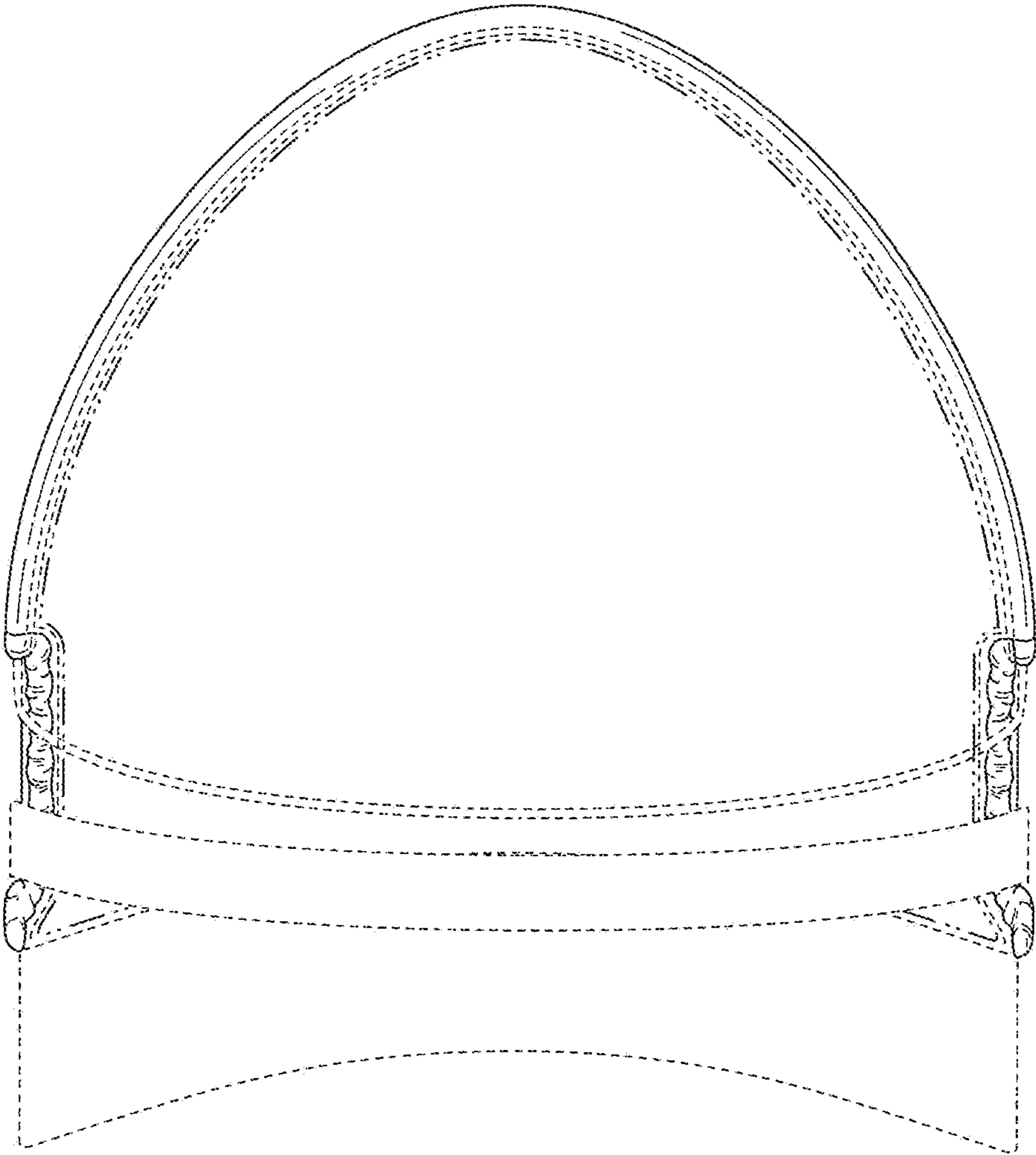

FIG. 7

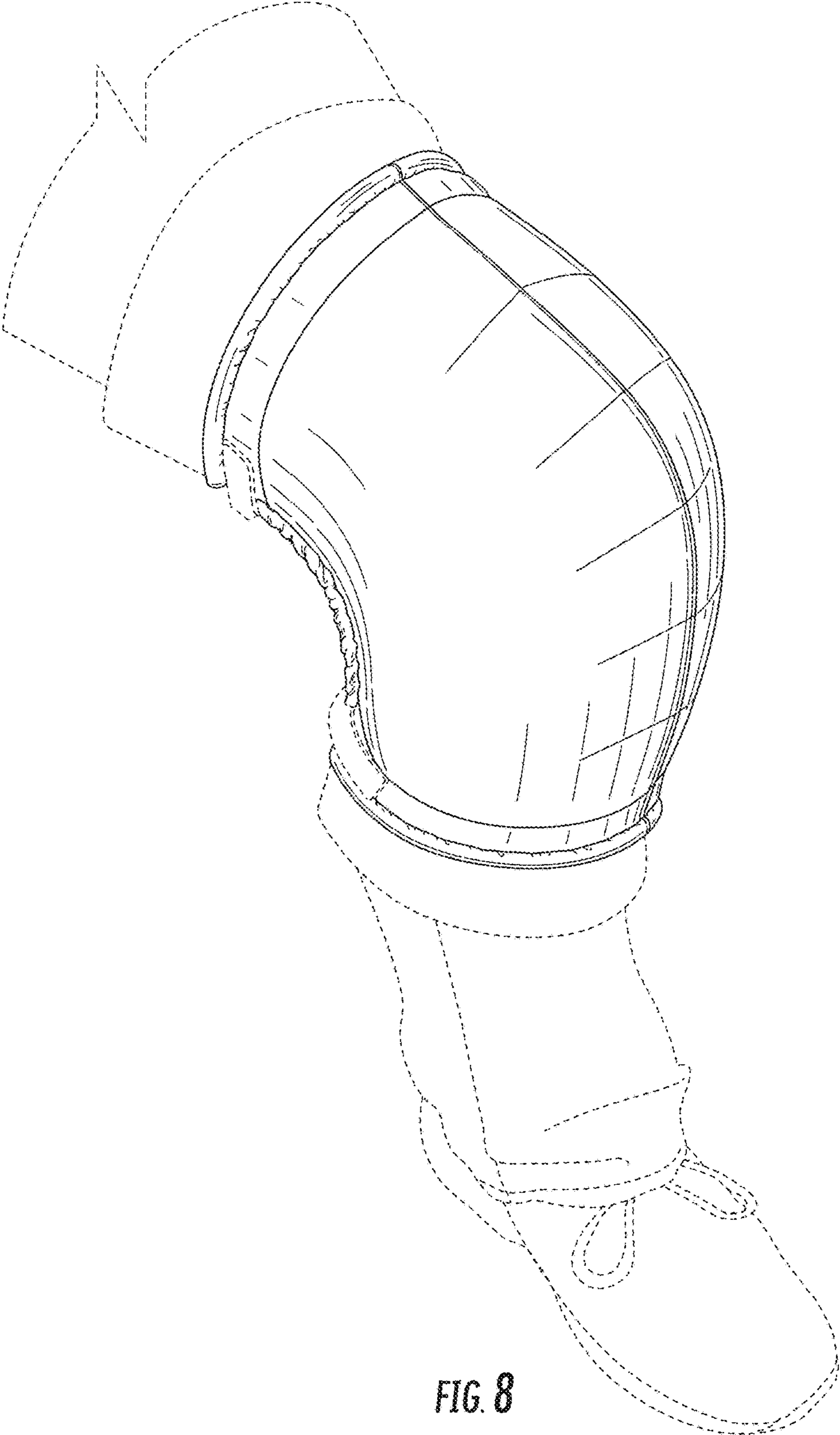

FIG. 8