



US00D818095S

(12) **United States Design Patent**
Cho et al.

(10) **Patent No.:** **US D818,095 S**

(45) **Date of Patent:** **** May 15, 2018**

(54) **AIR PURIFIER**

(71) Applicant: **LG ELECTRONICS INC.**, Seoul (KR)

(72) Inventors: **Kyeongchul Cho**, Seoul (KR); **Huijae Kwon**, Seoul (KR); **Yong Kim**, Seoul (KR); **Sehwan Bae**, Seoul (KR); **Kihyuk Kim**, Seoul (KR)

(73) Assignee: **LG Electronics Inc.**, Seoul (KR)

(**) Term: **15 Years**

(21) Appl. No.: **35/501,895**

(22) Filed: **May 12, 2016**

(80) **Hague Agreement Data**

Int. Filing Date: **May 12, 2016**

Int. Reg. No.: **DM/090753**

Int. Reg. Date: **May 12, 2016**

Int. Reg. Pub. Date: **Nov. 18, 2016**

(30) **Foreign Application Priority Data**

Dec. 4, 2015 (KR) 30-2015-0061990

(51) **LOC (11) Cl.** **23-04**

(52) **U.S. Cl.**
USPC **D23/364**

(58) **Field of Classification Search**

USPC D23/355, 356, 359, 364, 370, 386

CPC A61L 9/00; A61L 9/02; A61L 9/03; A61L 9/034; A61L 9/04; A61L 9/12; A61L 9/032; A61L 9/122; A61L 9/127; A61L 9/22; B01D 46/00; B01D 46/0002; B01D 46/20; F02M 35/04; F24F 13/20; A62B 21/00

See application file for complete search history.

(56) **References Cited**

U.S. PATENT DOCUMENTS

D648,016 S *	11/2011	Choi	D23/364
D648,429 S *	11/2011	Choi	D23/364
D754,310 S *	4/2016	Norman	D23/355
D755,942 S *	5/2016	Kim	D23/364
D773,027 S *	11/2016	Hu	D23/365
D799,016 S *	10/2017	Su	D23/364
D801,505 S *	10/2017	Yin	D23/364

* cited by examiner

Primary Examiner — Keli L Hill

(74) *Attorney, Agent, or Firm* — Birch, Stewart, Kolasch & Birch, LLP

(57) **CLAIM**

The ornamental design for an air purifier, as shown and described.

DESCRIPTION

1. Air purifier

1.1 is a perspective view of an air purifier showing our new design;

1.2 is a front elevation view thereof;

1.3 is a rear elevation view thereof;

1.4 is a left-side elevation view thereof;

1.5 is a right-side elevation view thereof;

1.6 is a top plan view thereof;

1.7 is a bottom plan view thereof;

1.8 is another perspective view thereof, in a use condition; and

1.9 is another top plan view thereof, showing an example of a display part being activated.

The broken line showing of portions of the air purifier is for the purpose of illustrating environment and forms no part of the claimed design.

1 Claim, 9 Drawing Sheets

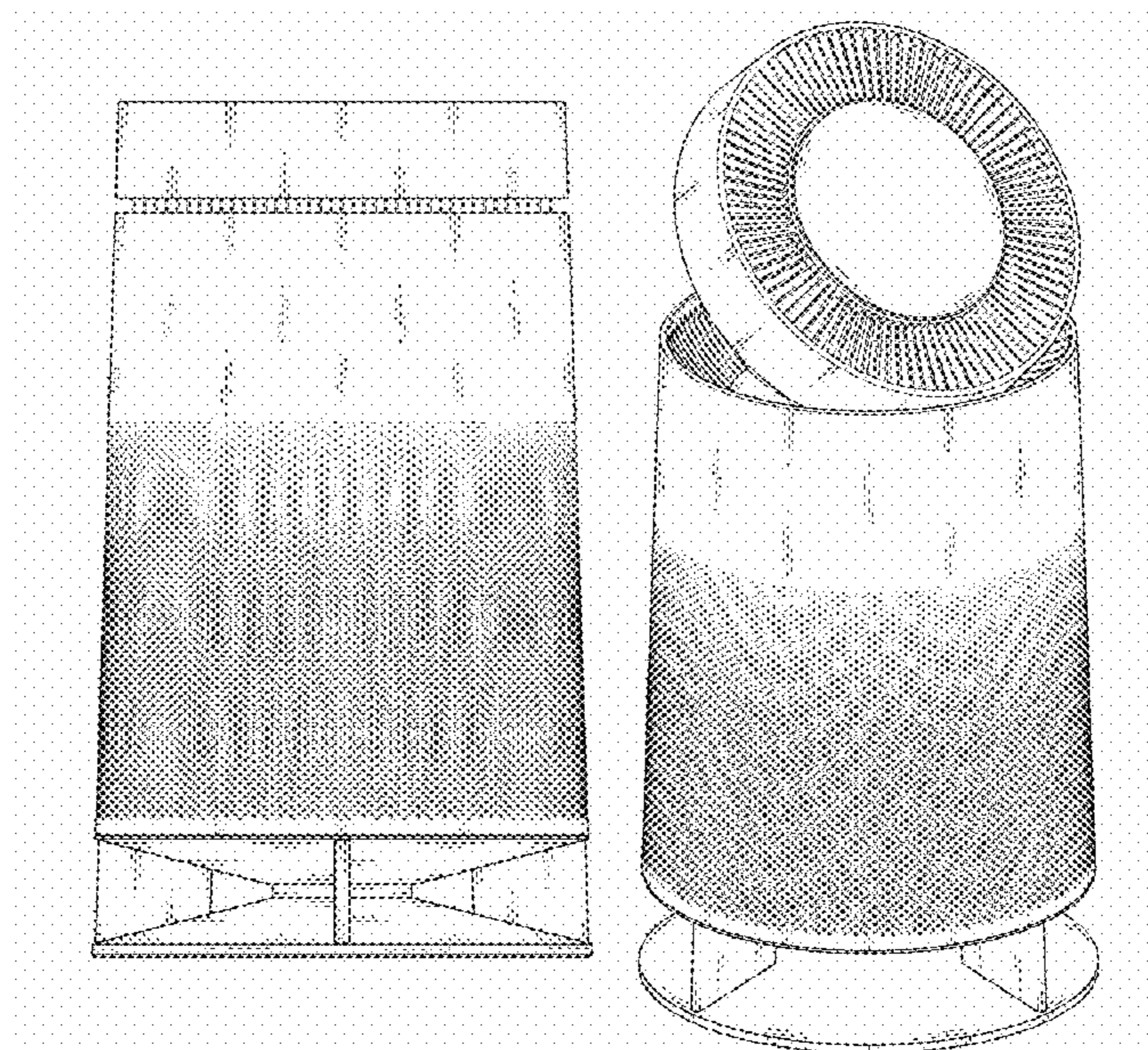

1.1

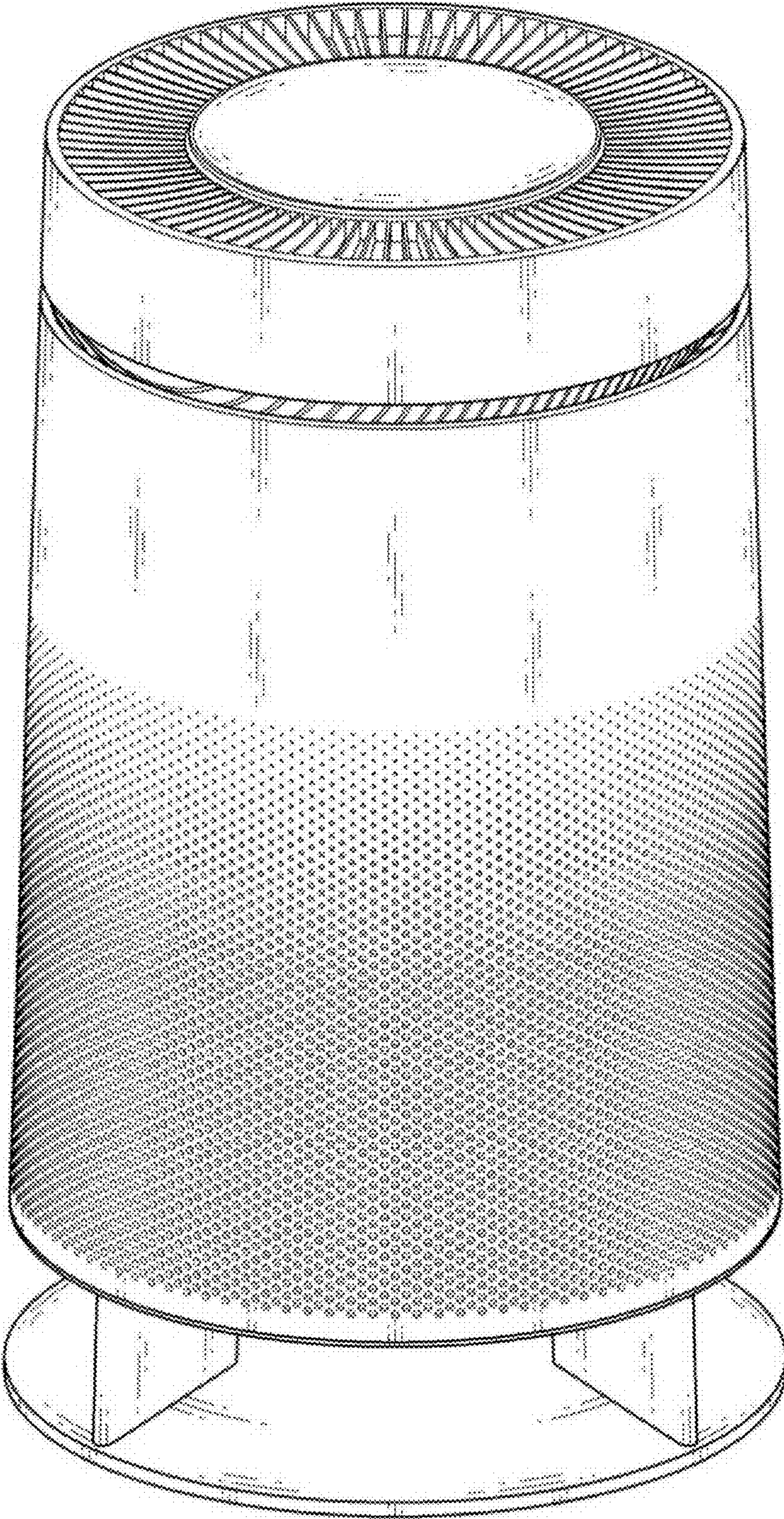

1.2

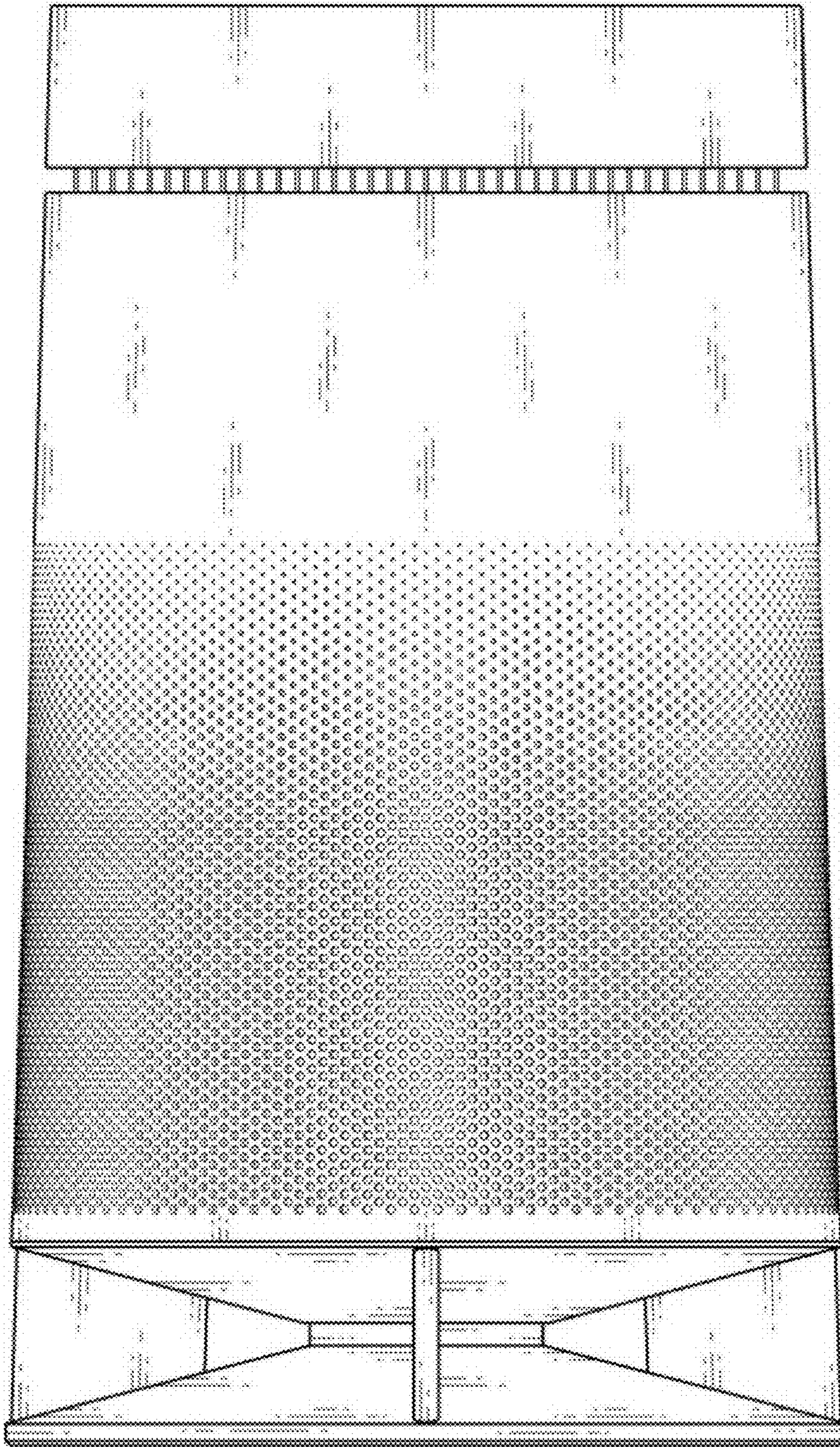

1.3

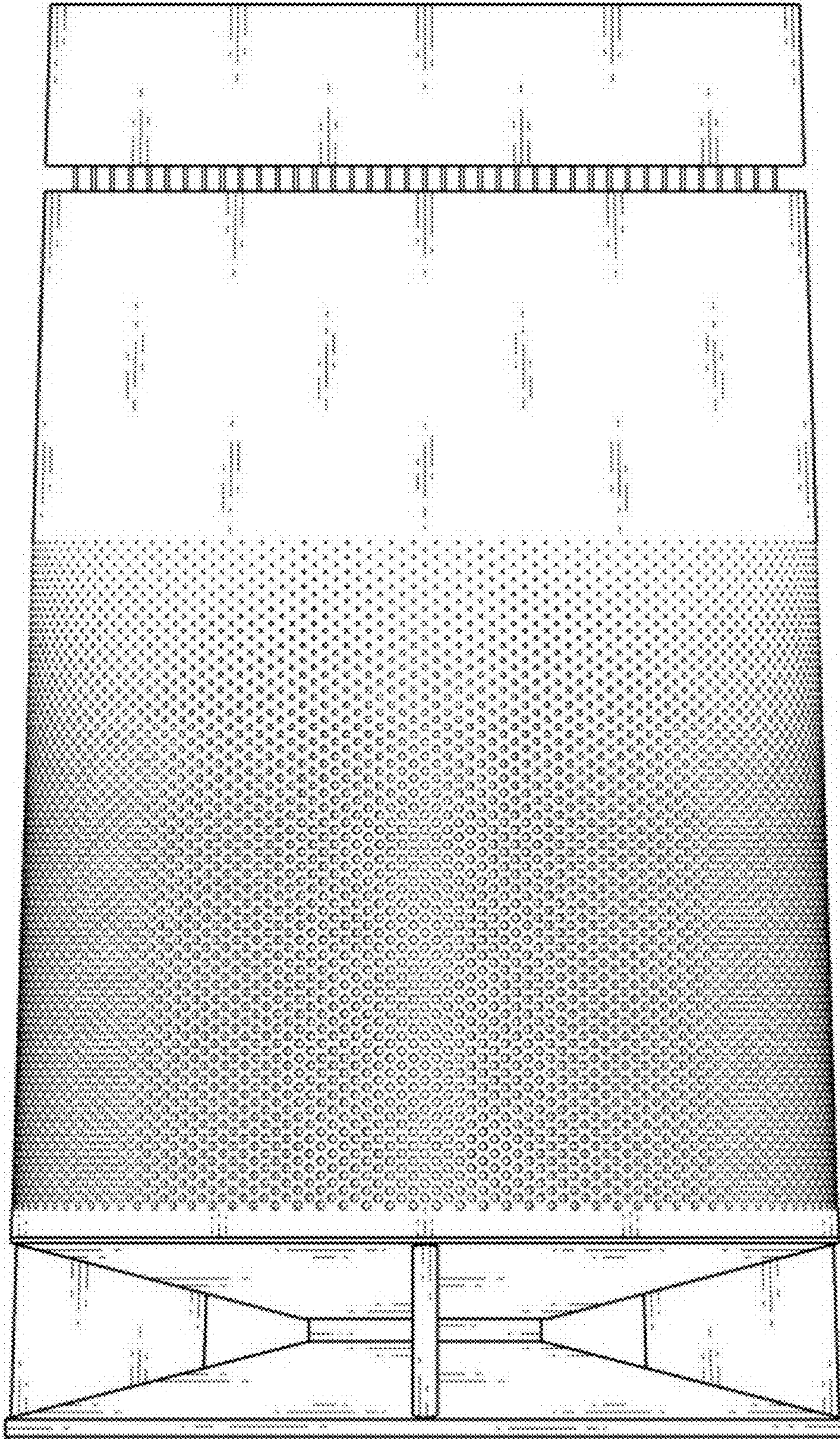

1.4

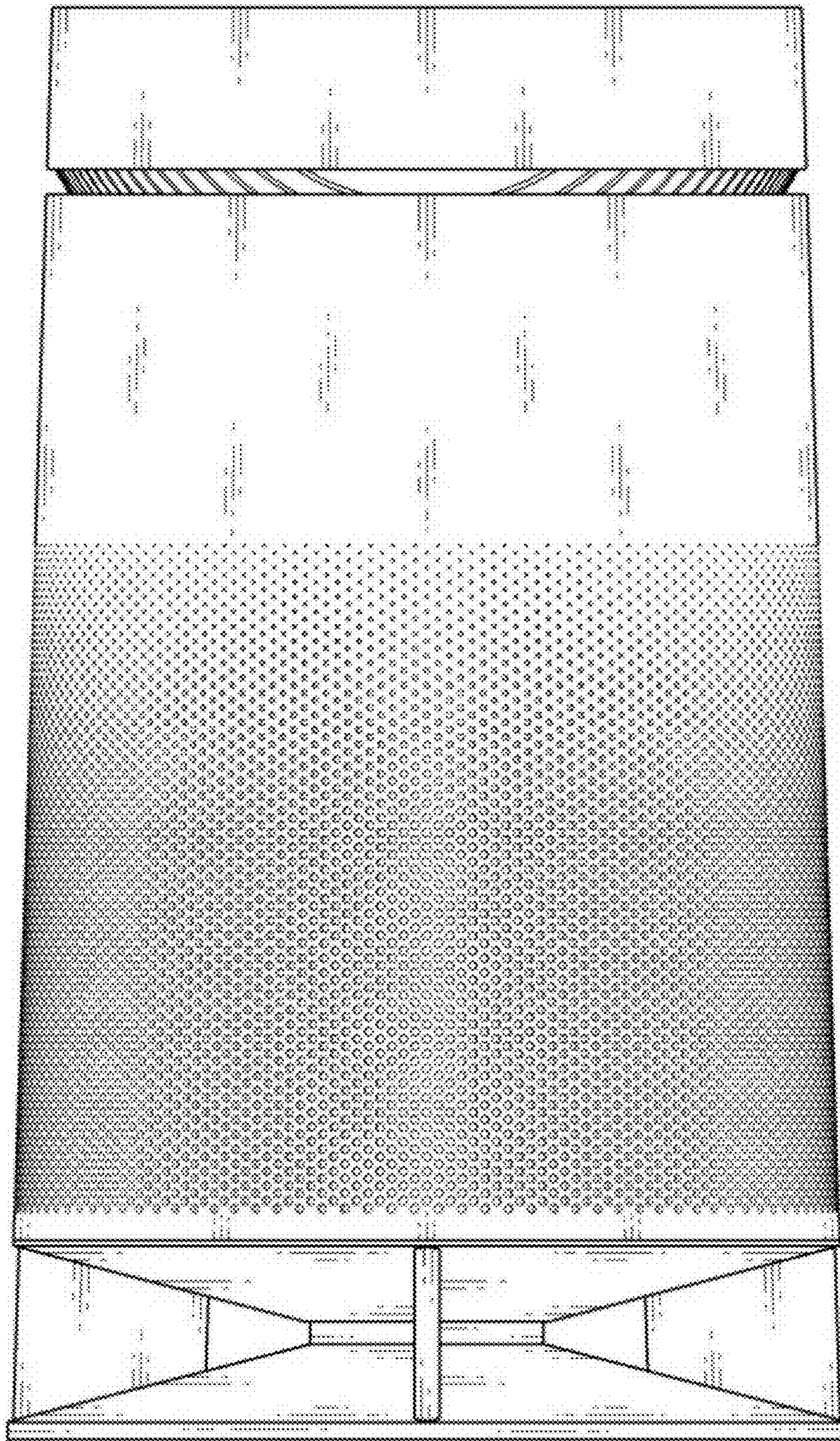

1.5

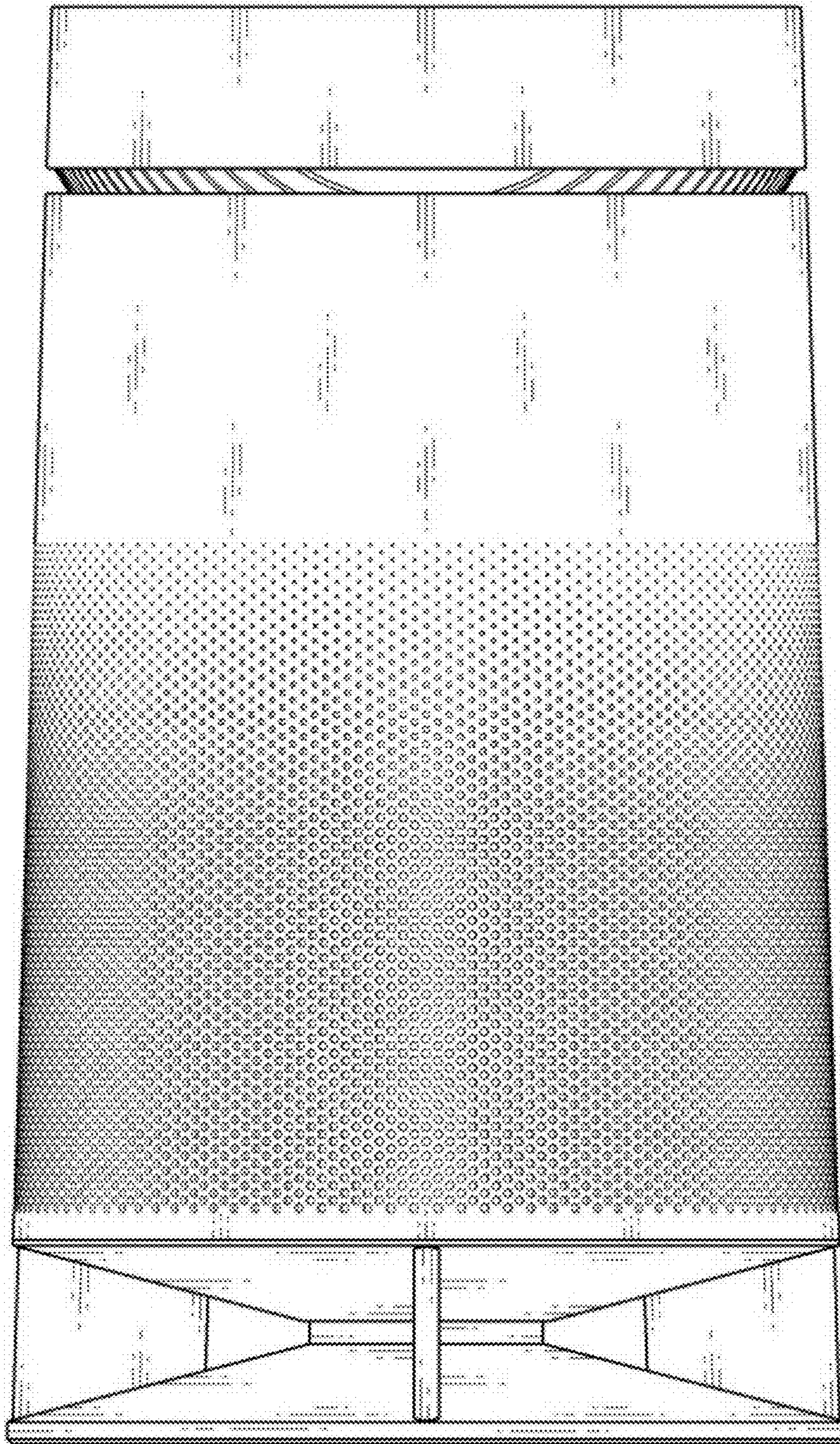

1.6

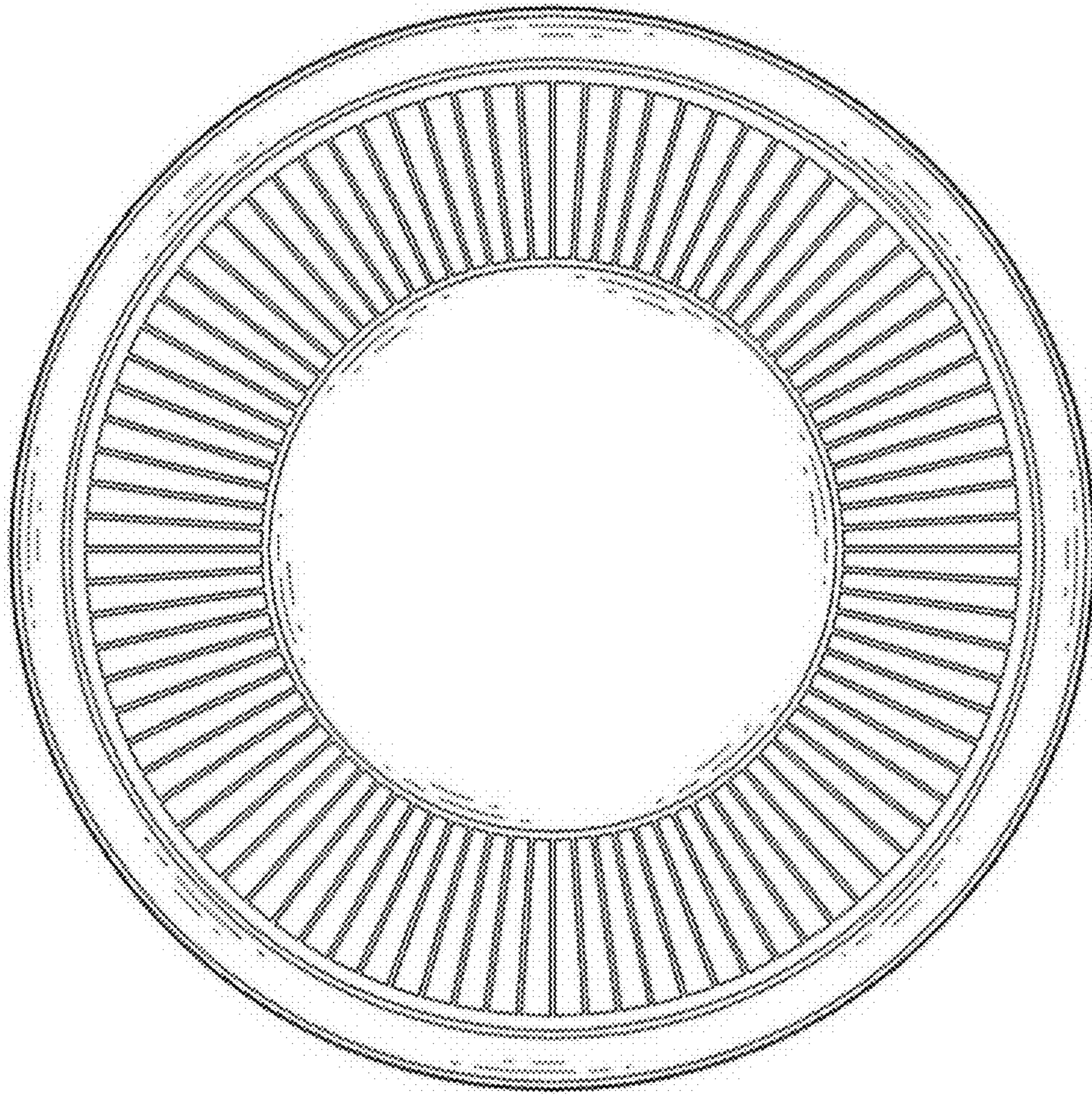

1.7

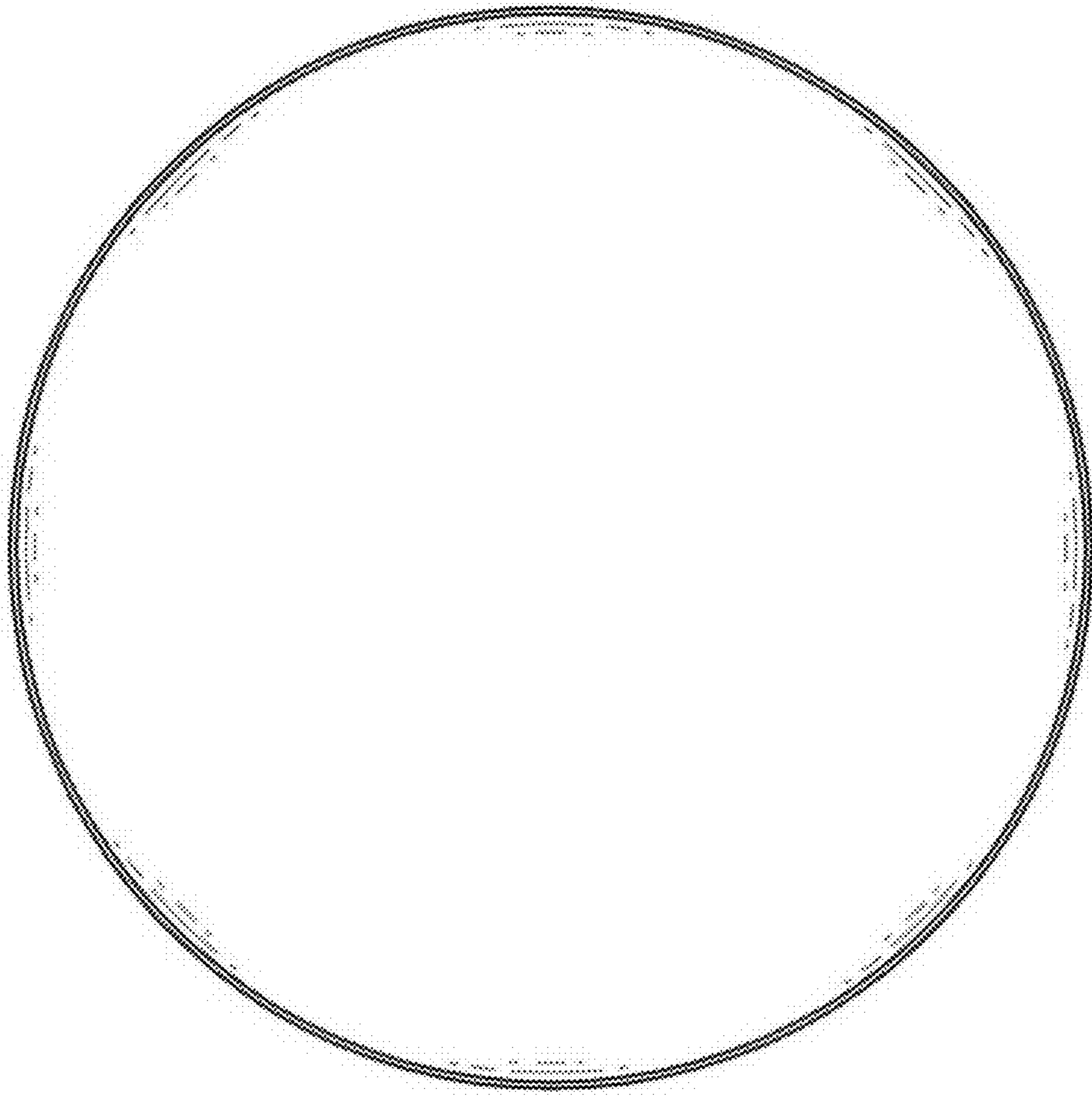

1.8

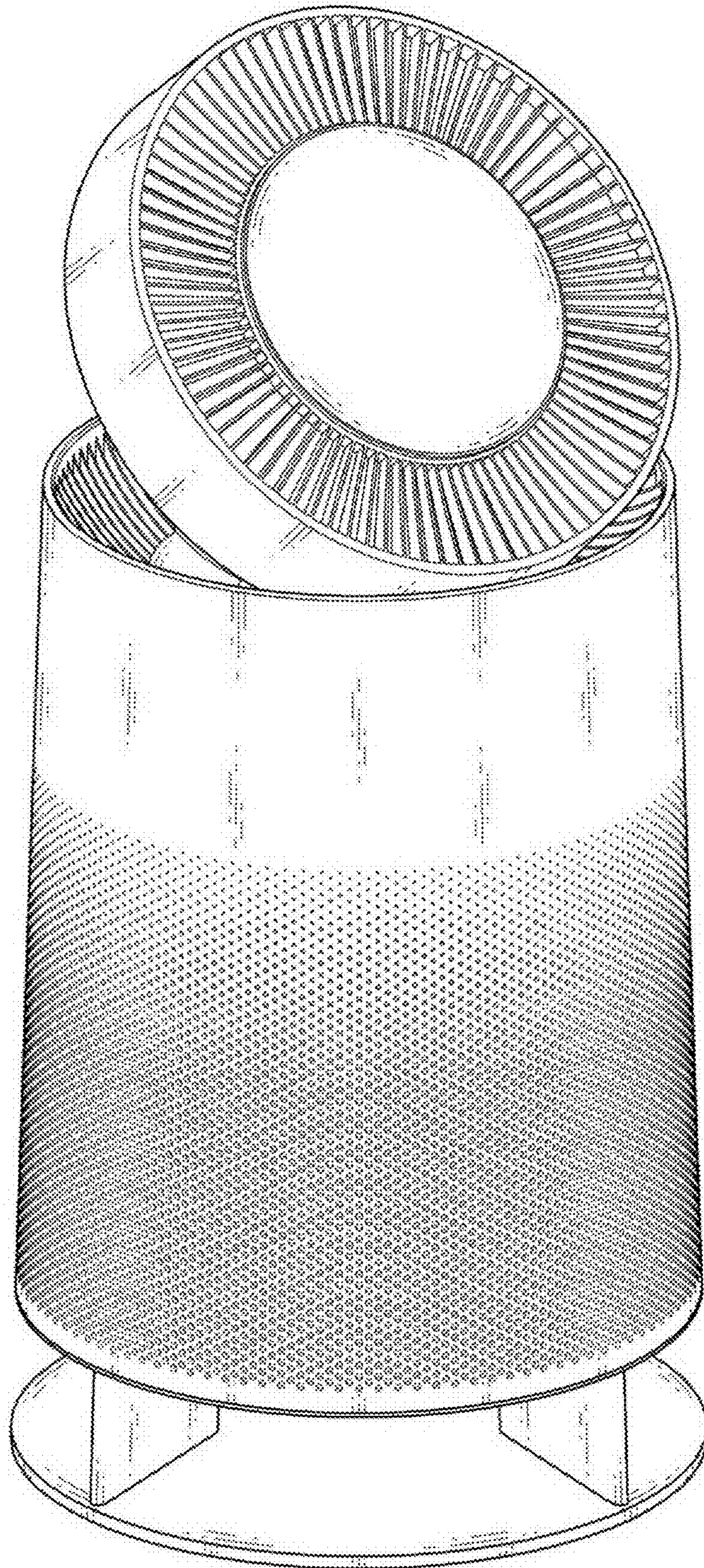

1.9

