



US00D817950S

(12) **United States Design Patent**
Lee et al.

(10) **Patent No.:** **US D817,950 S**
(45) **Date of Patent:** **** May 15, 2018**

(54) **PORTABLE ELECTRONIC DEVICE**

- (71) Applicant: **Samsung Electronics Co., Ltd.**,
Suwon-si (KR)
- (72) Inventors: **Yongyeon Lee**, Suwon-si (KR); **Ji-Yeon Kwak**, Seoul (KR); **Haeyoon Park**,
Seoul (KR); **Kio Lee**, Seoul (KR)
- (73) Assignee: **Samsung Electronics Co., Ltd.**,
Suwon-si (KR)
- (**) Term: **15 Years**
- (21) Appl. No.: **29/554,392**
- (22) Filed: **Feb. 11, 2016**

(30) **Foreign Application Priority Data**

- Aug. 18, 2015 (KR) 30-2015-0041437
- (51) **LOC (11) Cl.** **14-02**
- (52) **U.S. Cl.**
USPC **D14/341**
- (58) **Field of Classification Search**
USPC D14/341-347, 125-134, 137, 138 R,
D14/138 AA, 138 AB, 138 C, 138 G, 147,
(Continued)

(56) **References Cited**

U.S. PATENT DOCUMENTS

- D506,937 S * 7/2005 Lee D10/65
 - D583,810 S * 12/2008 Chen D14/315
- (Continued)

FOREIGN PATENT DOCUMENTS

- EM 001359855-0001 2/2013
 - EM 002262667-0001 7/2013
- (Continued)

OTHER PUBLICATIONS

Latest Transparent Phone—Phones—Nairaland, posted Nov. 22, 2013, [retrieved Aug. 17, 2017]. Retrieved from Internet, <URL: <http://www.nairaland.com/1527260/latest-transparent-phone> >.*

(Continued)

Primary Examiner — Barbara Fox

Assistant Examiner — Kristin E Reed

(74) *Attorney, Agent, or Firm* — NSIP Law

(57) **CLAIM**

We claim the ornamental design for a portable electronic device, as shown and described.

DESCRIPTION

FIG. 1 is a front perspective view of a portable electronic device showing our new design;
 FIG. 2 is a front view thereof;
 FIG. 3 is a rear view thereof;
 FIG. 4 is a left-side view thereof;
 FIG. 5 is a right-side view thereof;
 FIG. 6 is a top view thereof;
 FIG. 7 is a bottom view thereof;
 FIG. 8 is a rear perspective view thereof;
 FIG. 9 is a front view of the portable electronic device in which a flip cover is provided in dash-dot broken lines to illustrate an example environment; and,
 FIG. 10 is an exploded front perspective view of the portable electronic device, as shown in FIG. 9 in which the flip cover portion is shown separated from the portable electronic device.

The short dash-dash broken line in the figures depict portions of the portable electronic device. The dash-dot broken line in FIGS. 9 and 10 showing the flip cover are for the purpose of illustrating environmental structure. The broken lines form no part of the claimed design.

1 Claim, 10 Drawing Sheets

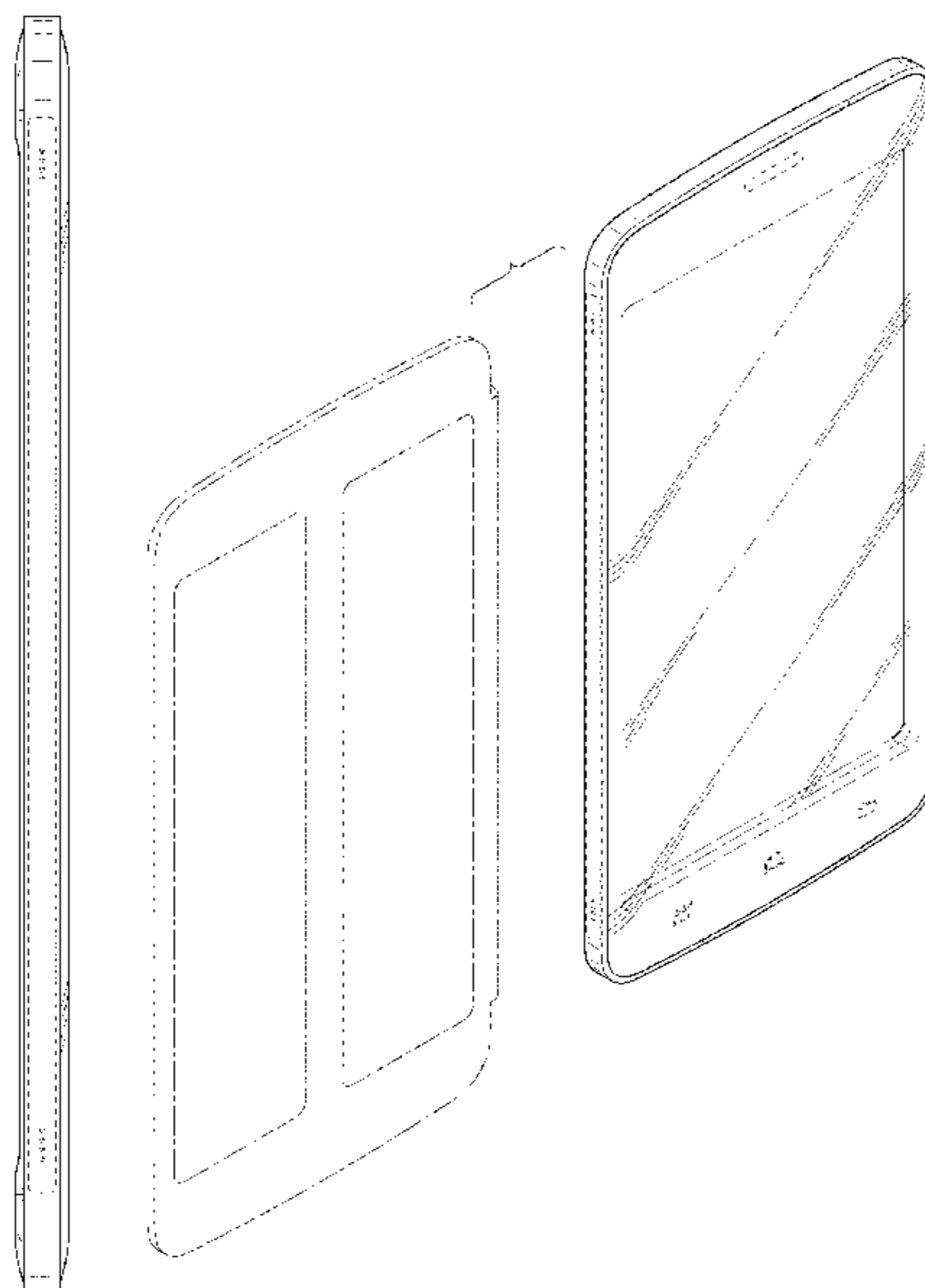

(58) **Field of Classification Search**

USPC ... D14/203.1, 203.3, 203.4, 203.7, 218, 247,
 D14/248, 332, 336, 371, 374-377, 388,
 D14/389, 315-318, 420, 426, 429, 440,
 D14/448, 450, 489, 492, 496;
 D6/300-310; D16/241; D18/6; D20/10,
 D20/19, 39; D21/329, 330
 CPC . A63H 33/3016; G06F 1/1613; G06F 1/1641;
 G06F 1/1643; G06F 1/1647; G06F
 3/04883; G06F 3/0486; G06F 3/04847;
 G06F 3/04845; G06F 3/0484; G06F
 3/04817; H05K 5/0004; H05K 5/0017;
 H05K 5/02; H05K 5/0217; H04M 1/0279;
 H04M 1/0281; H04M 1/0283; H04N
 13/0459

See application file for complete search history.

(56) **References Cited**

U.S. PATENT DOCUMENTS

D611,365 S * 3/2010 Stevens D10/65
 D639,269 S * 6/2011 Kim D14/203.3
 D639,772 S * 6/2011 Kim D14/203.3
 D657,331 S * 4/2012 Jung D14/138 G
 8,195,243 B2 * 6/2012 Kim G06F 1/1616
 345/156
 D664,516 S * 7/2012 Park D14/138 AD
 D675,209 S * 1/2013 Glanzer D14/440
 D677,660 S * 3/2013 Groene D14/341
 D689,455 S * 9/2013 Daniel D10/65
 D698,779 S * 2/2014 Kaula D14/341
 D702,681 S * 4/2014 Sugiyama D14/341
 D722,051 S * 2/2015 Inada D14/341
 D740,803 S * 10/2015 Yamazaki D14/341
 D744,595 S * 12/2015 Chapman D20/39

D746,800 S * 1/2016 Park D14/248
 D785,585 S * 5/2017 Ismail D14/137
 2012/0194448 A1 * 8/2012 Rothkopf A45C 13/002
 345/173

FOREIGN PATENT DOCUMENTS

KR 30-2011-054753 11/2013
 KR 30-2013-0049601 4/2014

OTHER PUBLICATIONS

Tony Stark's Transparent Phone Possible With Graphene?, posted Oct. 16, 2012, [retrieved Aug. 17, 2017]. Retrieved from Internet, <URL: <http://www.technovelgy.com/ct/Science-Fiction-News.asp?NewsNum=3785> >.*
 Take a look through this transparent smartphone screen, posted May 31, 2012, [retrieved Aug. 17, 2017]. Retrieved from Internet, <URL: <https://www.cnet.com/news/changing-the-face-of-technology-women-in-technology/> >.*
 Top 5-Inch Budget Android Phones, posted Feb. 20, 2013, [retrieved Aug. 17, 2017]. Retrieved from Internet, <URL: <http://www.indiatimes.com/technology/mobile/top-5inch-budget-android-phones-61857.html> >.*
 "Mill sell folding mobile phone case for iphone 6+ Wholesale". [2015] www.mobofree.com Mar. 30, 2015 <<http://www.mobofree.com/nigeria/Phones-tablets-mobile-devices/Accessories-Parts/mill-sell-folding-mobile-phone-case-for-iphone-6-WHOLESALE/1281620>>.*
 Nouske. "Nouske Flip Folio Wallet Stand Up Lightweight Leather Cover with Magetic Closure Auto Lock Feature for iPhone 6 plus 5.5-Inch (Gold)" [2016] www.amazon.com/ Feb. 8, 2016 <http://www.amazon.com/Nouske-Magnetic-Suffient-protetion-Lightweight/dp/B00YBXDAUO/ref=sr_1_1?s=wireless&ie=UTF8&qid=1437009936&sr=1-1&pebp=1437009940473&perid=1HVSV07DVWJP69N9M5P5>.*

* cited by examiner

FIG. 1

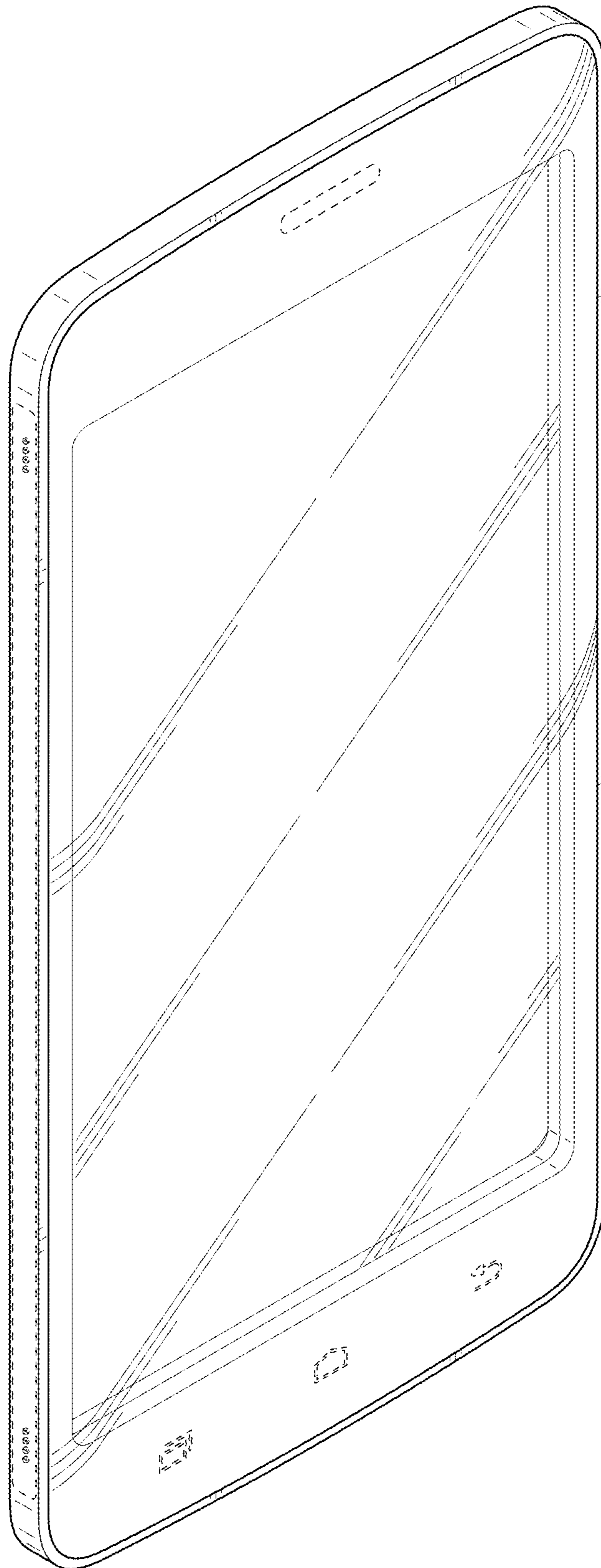

FIG. 2

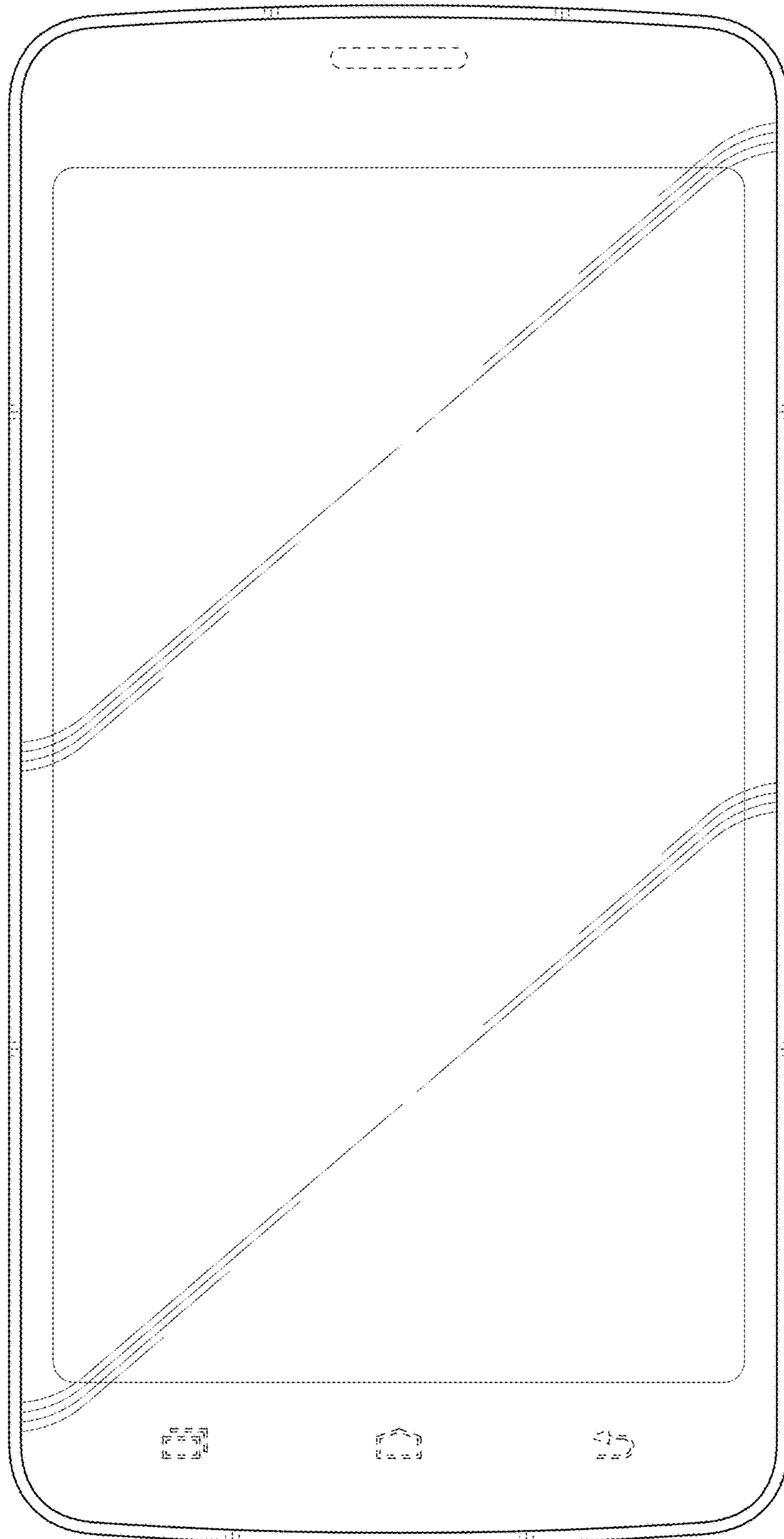

FIG. 3

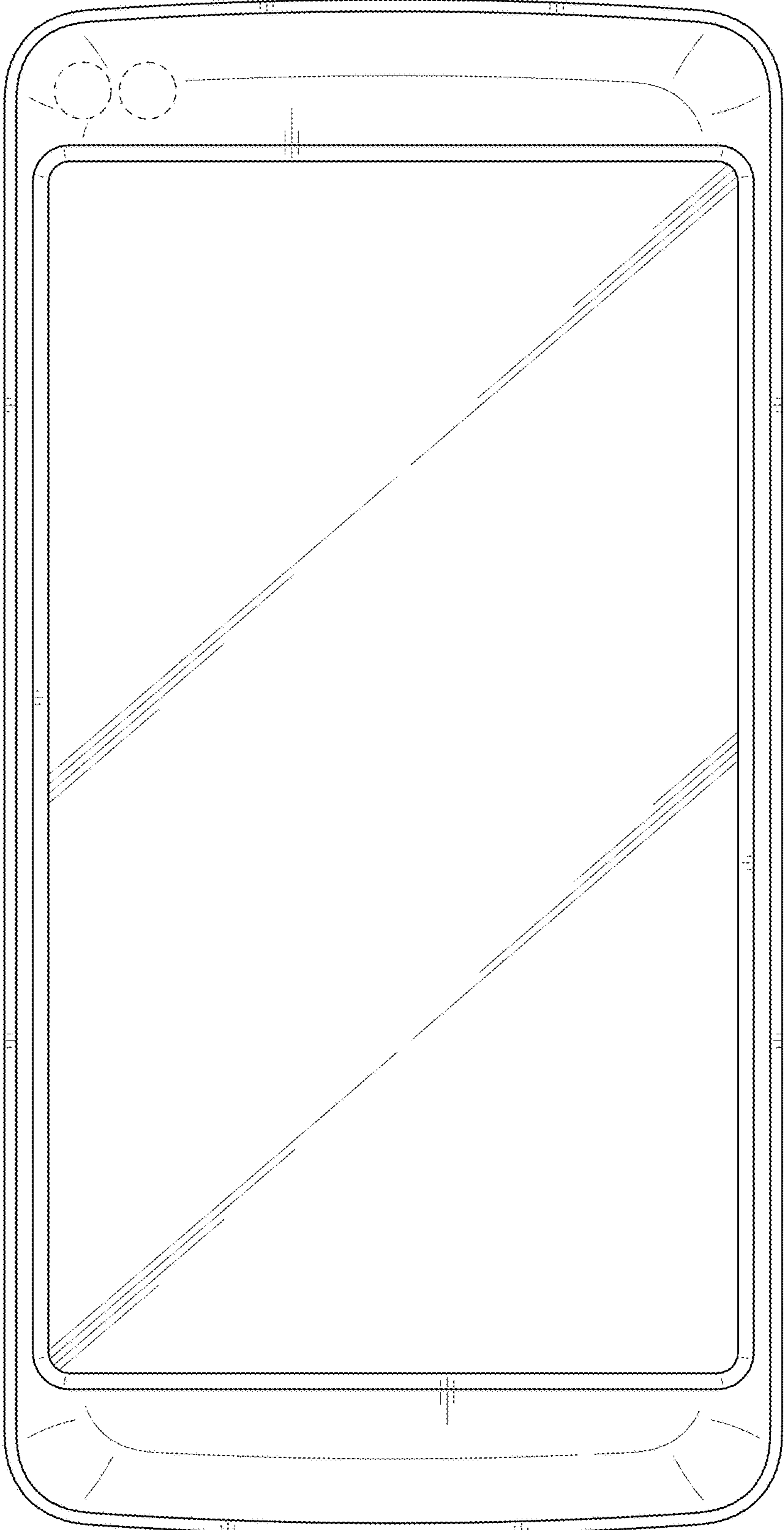

FIG. 4

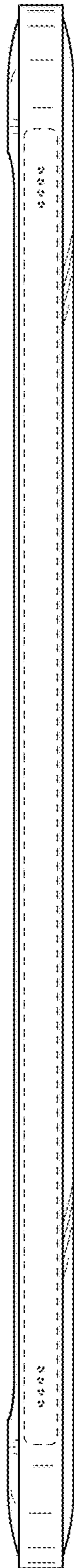

FIG. 5

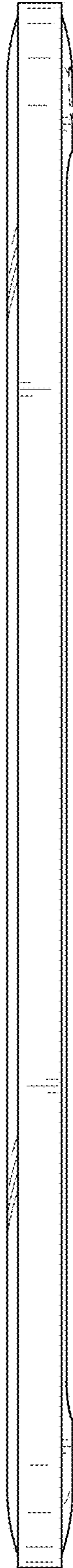

FIG. 6

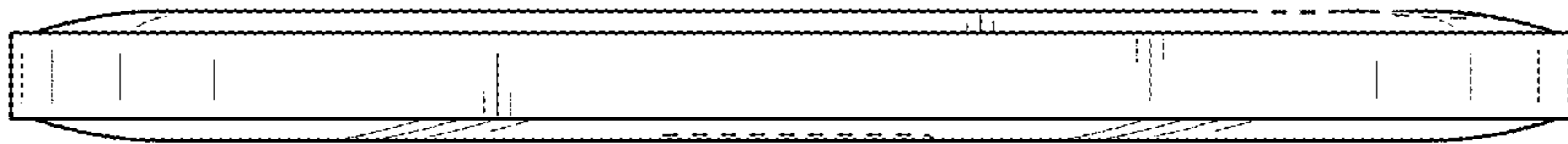

FIG. 7



FIG. 8

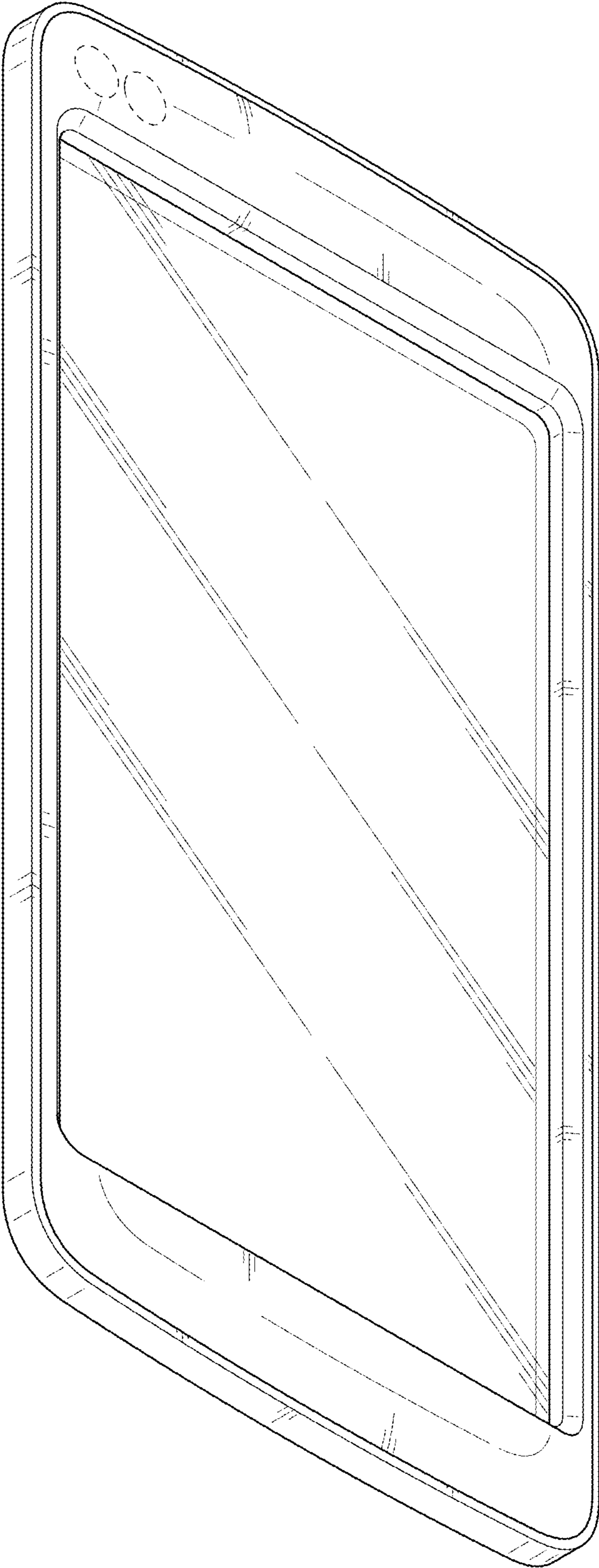

FIG. 9

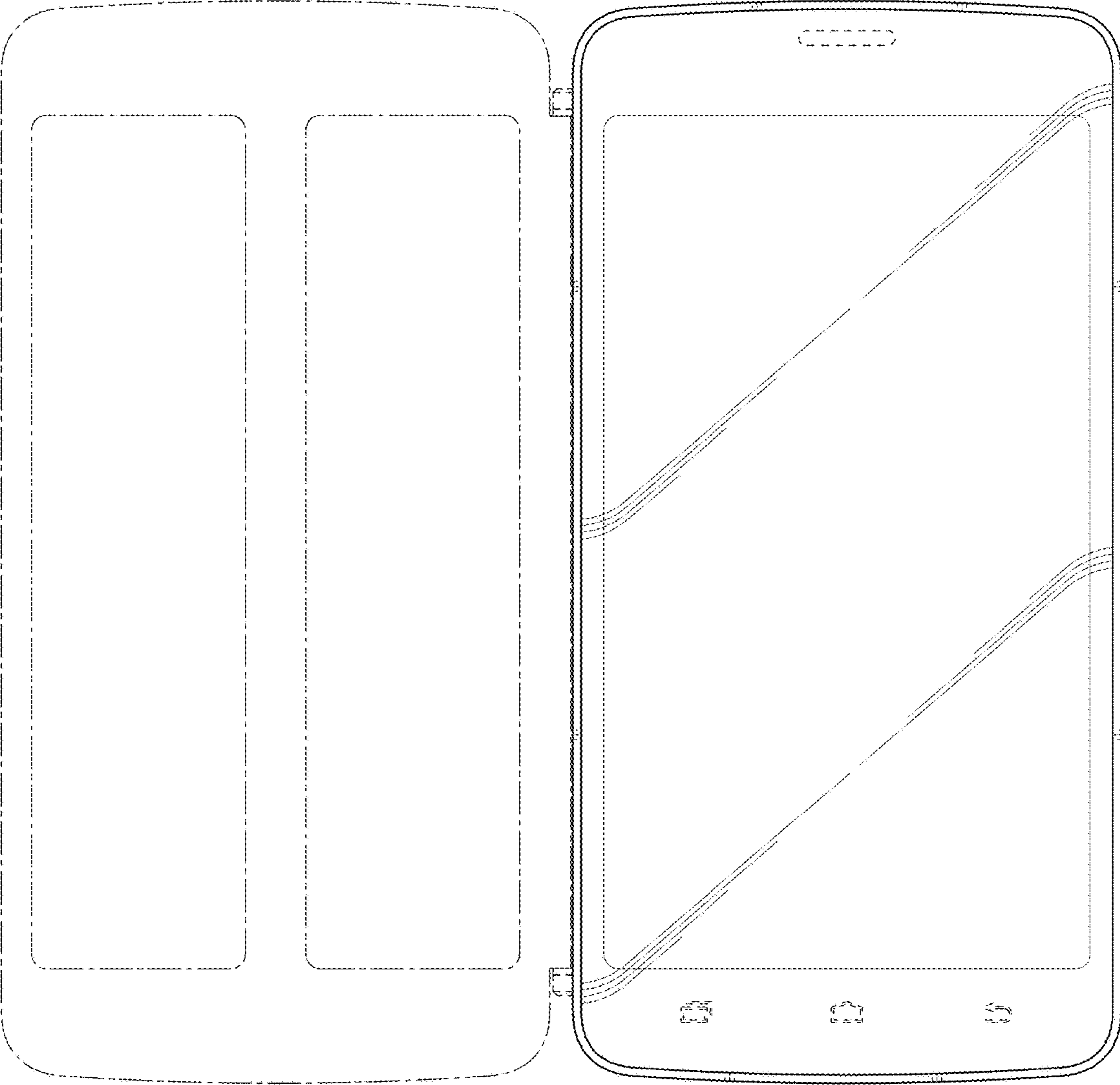

FIG. 10

