



US00D817862S

(12) **United States Design Patent**
Cameron

(10) **Patent No.:** **US D817,862 S**
(45) **Date of Patent:** **** May 15, 2018**

(54) **SOLAR PANEL ARRANGEMENT**

(71) Applicant: **James Francis Cameron**, Encino, CA
(US)

(72) Inventor: **James Francis Cameron**, Encino, CA
(US)

(**) Term: **15 Years**

(21) Appl. No.: **29/547,815**

(22) Filed: **Dec. 8, 2015**

Related U.S. Application Data

(63) Continuation-in-part of application No. 29/527,016,
filed on May 14, 2015, now Pat. No. Des. 783,522.

(51) **LOC (11) Cl.** **13-02**

(52) **U.S. Cl.**
USPC **D13/102**

(58) **Field of Classification Search**

USPC D13/102, 101, 103, 118, 119, 184, 199;
126/561, 667; 136/206, 244, 251, 291,
136/292; 438/597

(Continued)

(56) **References Cited**

U.S. PATENT DOCUMENTS

D600,200 S 9/2009 Dimov et al.
D701,828 S * 4/2014 Garrett-Schesch D13/102
(Continued)

Primary Examiner — Derrick Holland

Assistant Examiner — Jennifer O King

(74) *Attorney, Agent, or Firm* — Kevin Schraven; Anooj
Patel; Hankin Patent Law, APC

(57) **CLAIM**

The ornamental design for a solar panel arrangement, as
shown and described.

DESCRIPTION

FIG. 1 is a top perspective view of a first embodiment of the
solar panel arrangement, showing my new design.

FIG. 2 is a bottom perspective view thereof.
FIG. 3 is a front elevational view thereof.
FIG. 4 is a side elevational view thereof.
FIG. 5 is a rear elevational view thereof.
FIG. 6 is a top plan view thereof.
FIG. 7 is a bottom plan view thereof.
FIG. 8 is a top perspective view of a second embodiment of
the solar panel arrangement, showing my new design.
FIG. 9 is a bottom perspective view thereof.
FIG. 10 is a front elevational view thereof.
FIG. 11 is a side elevational view thereof.
FIG. 12 is a rear elevational view thereof.
FIG. 13 is a top plan view thereof.
FIG. 14 is a bottom plan view thereof.
FIG. 15 is a top perspective view of a third embodiment of
the solar panel arrangement, showing my new design.
FIG. 16 is a bottom perspective view thereof.
FIG. 17 is a front elevational view thereof.
FIG. 18 is a side elevational view thereof.
FIG. 19 is a rear elevational view thereof.
FIG. 20 is a top plan view thereof.
FIG. 21 is a bottom plan view thereof.
FIG. 22 is a top perspective view of a fourth embodiment of
the solar panel arrangement, showing my new design.
FIG. 23 is a bottom perspective view thereof.
FIG. 24 is a front elevational view thereof.
FIG. 25 is a side elevational view thereof.
FIG. 26 is a rear elevational view thereof.
FIG. 27 is a top plan view thereof.
FIG. 28 is a bottom plan view thereof.
FIG. 29 is a top perspective view of a fifth embodiment of
the solar panel arrangement, showing my new design.
FIG. 30 is a bottom perspective view thereof.
FIG. 31 is a front elevational view thereof.
FIG. 32 is a side elevational view thereof.
FIG. 33 is a rear elevational view thereof.
FIG. 34 is a top plan view thereof.
FIG. 35 is a bottom plan view thereof.
FIG. 36 is a top perspective view of a sixth embodiment of
the solar panel arrangement, showing my new design.
FIG. 37 is a bottom perspective view thereof.
FIG. 38 is a front elevational view thereof.
FIG. 39 is a side elevational view thereof.

(Continued)

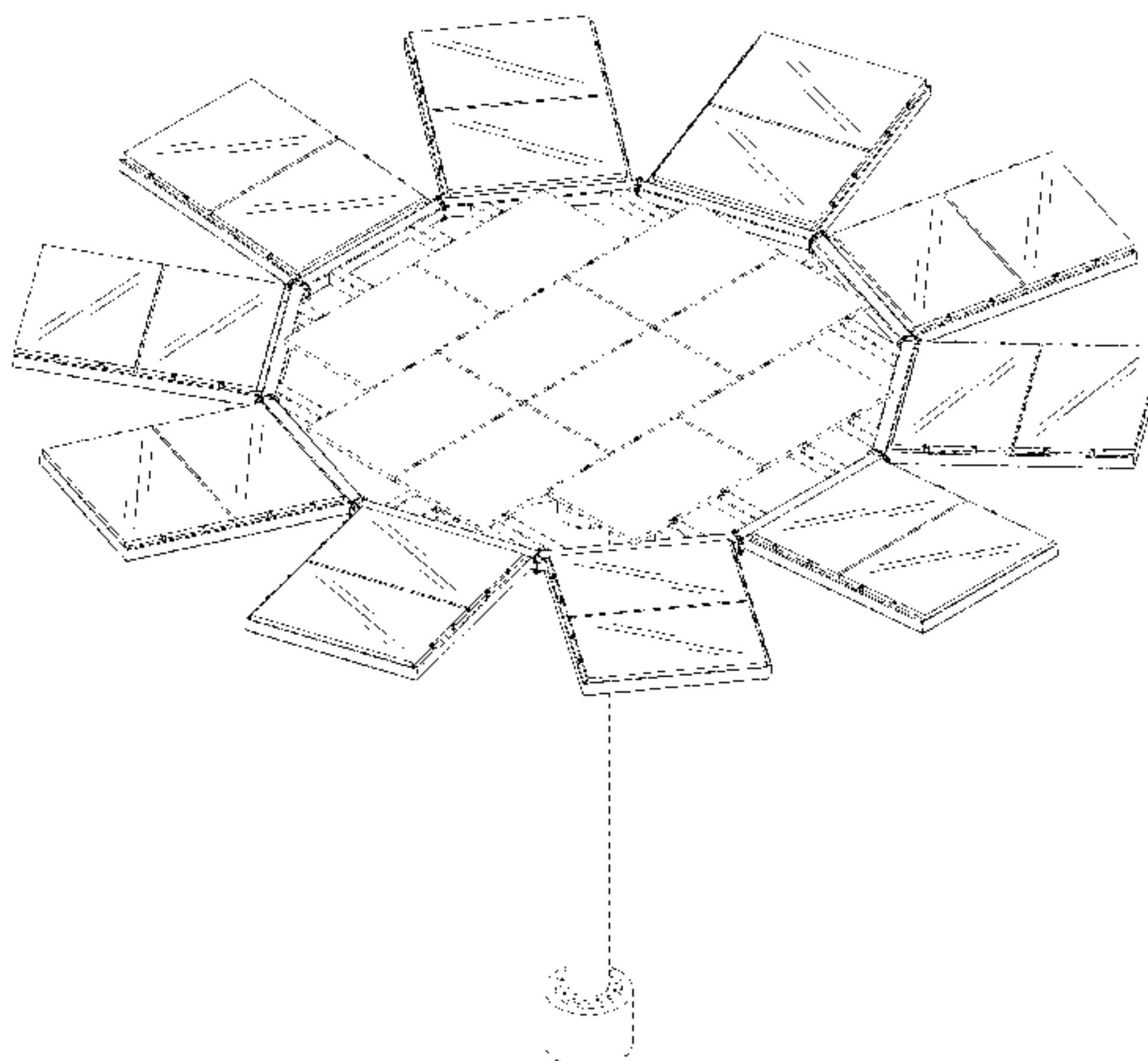

FIG. 40 is a rear elevational view thereof.
FIG. 41 is a top plan view thereof.
FIG. 42 is a bottom plan view thereof.
FIG. 43 is a top perspective view of a seventh embodiment of the solar panel arrangement, showing my new design.
FIG. 44 is a bottom perspective view thereof.
FIG. 45 is a front elevational view thereof.
FIG. 46 is a side elevational view thereof.
FIG. 47 is a rear elevational view thereof.
FIG. 48 is a top plan view thereof.
FIG. 49 is a bottom plan view thereof.
FIG. 50 is a top perspective view of an eighth embodiment of the solar panel arrangement, showing my new design.
FIG. 51 is a bottom perspective view thereof.
FIG. 52 is a front elevational view thereof.
FIG. 53 is a side elevational view thereof.
FIG. 54 is a rear elevational view thereof.
FIG. 55 is a top plan view thereof.
FIG. 56 is a bottom plan view thereof.
FIG. 57 is a top perspective view of a ninth embodiment of the solar panel arrangement, showing my new design.
FIG. 58 is a bottom perspective view thereof.
FIG. 59 is a front elevational view thereof.
FIG. 60 is a side elevational view thereof.
FIG. 61 is a rear elevational view thereof.
FIG. 62 is a top plan view thereof.
FIG. 63 is a bottom plan view thereof.
FIG. 64 is a top perspective view of a tenth embodiment of the solar panel arrangement, showing my new design.
FIG. 65 is a bottom perspective view thereof.

FIG. 66 is a front elevational view thereof.
FIG. 67 is a side elevational view thereof.
FIG. 68 is a rear elevational view thereof.
FIG. 69 is a top plan view thereof; and,
FIG. 70 is a bottom plan view thereof.
The broken lines are for the purpose of illustrating environmental structure and form no part of the claimed design.

1 Claim, 70 Drawing Sheets

(58) **Field of Classification Search**

CPC Y02E 10/47; Y02E 10/50; Y02E 10/52;
H02S 20/00; F24J 2/5237; H01L 31/042;
H01L 31/043; H01L 31/047; H01L
31/0475

See application file for complete search history.

(56) **References Cited**

U.S. PATENT DOCUMENTS

D724,524	S	*	3/2015	Garrett-Schesch	D13/102
D727,253	S	*	4/2015	Presley	D13/102
D728,466	S	*	5/2015	Ehram	D13/102
D755,120	S	*	5/2016	Pauschitz	D13/102
D758,062	S	*	6/2016	Akin	D13/102
D758,298	S	*	6/2016	Akin	D13/102
D783,522	S	*	4/2017	Cameron	D13/102
D797,657	S	*	9/2017	Lakamp	D13/102

* cited by examiner

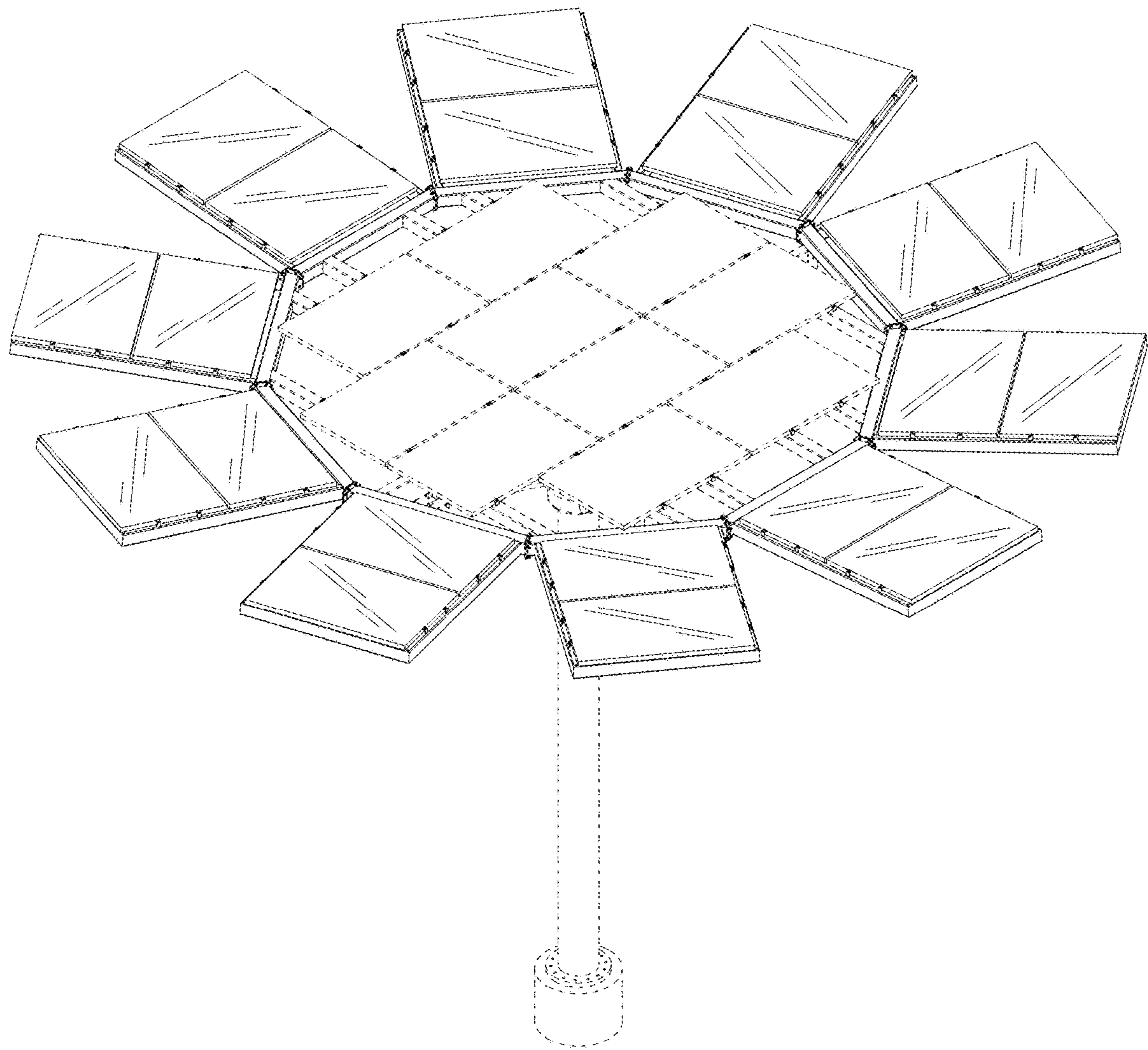

FIG. 1

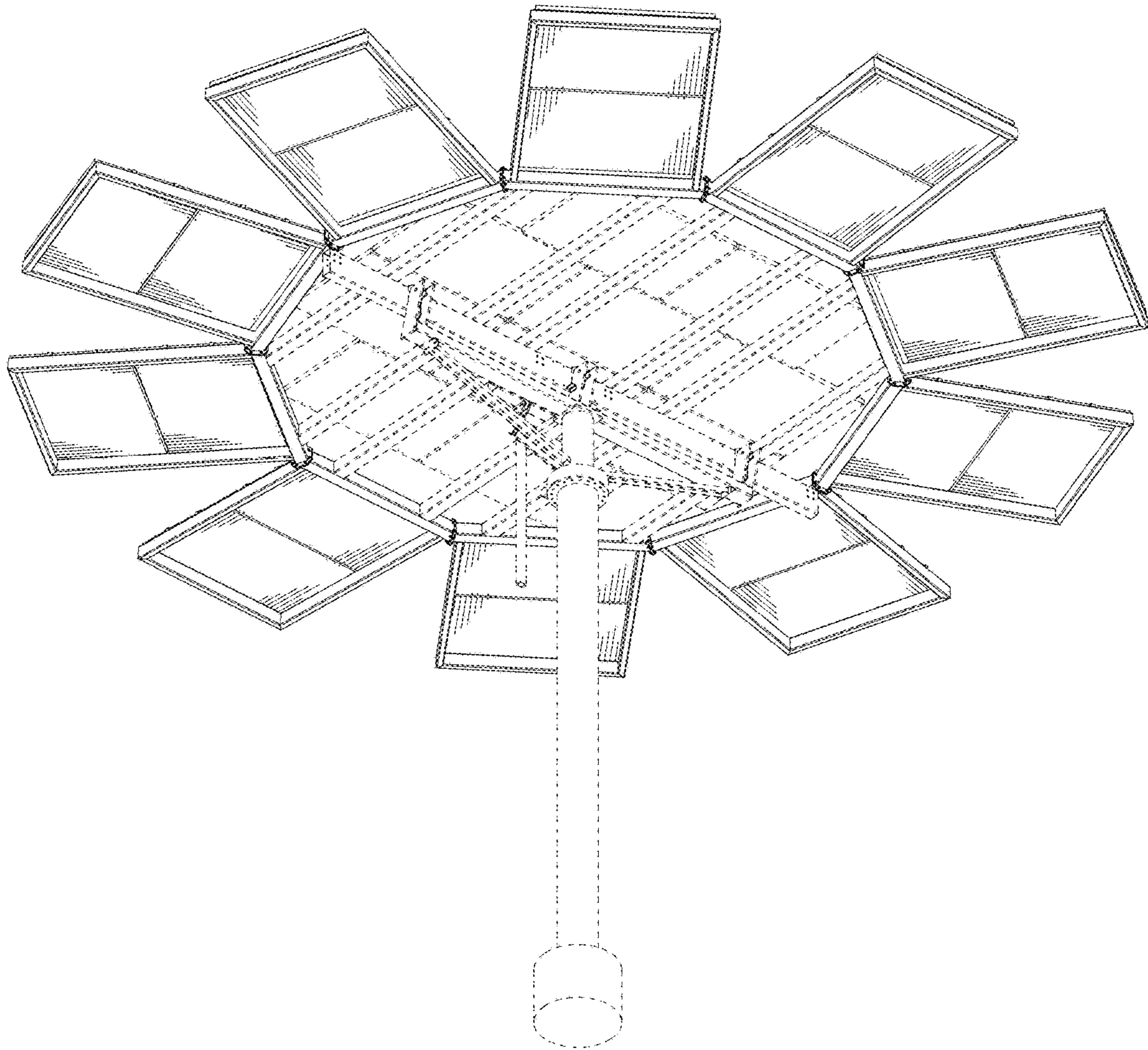

FIG. 2

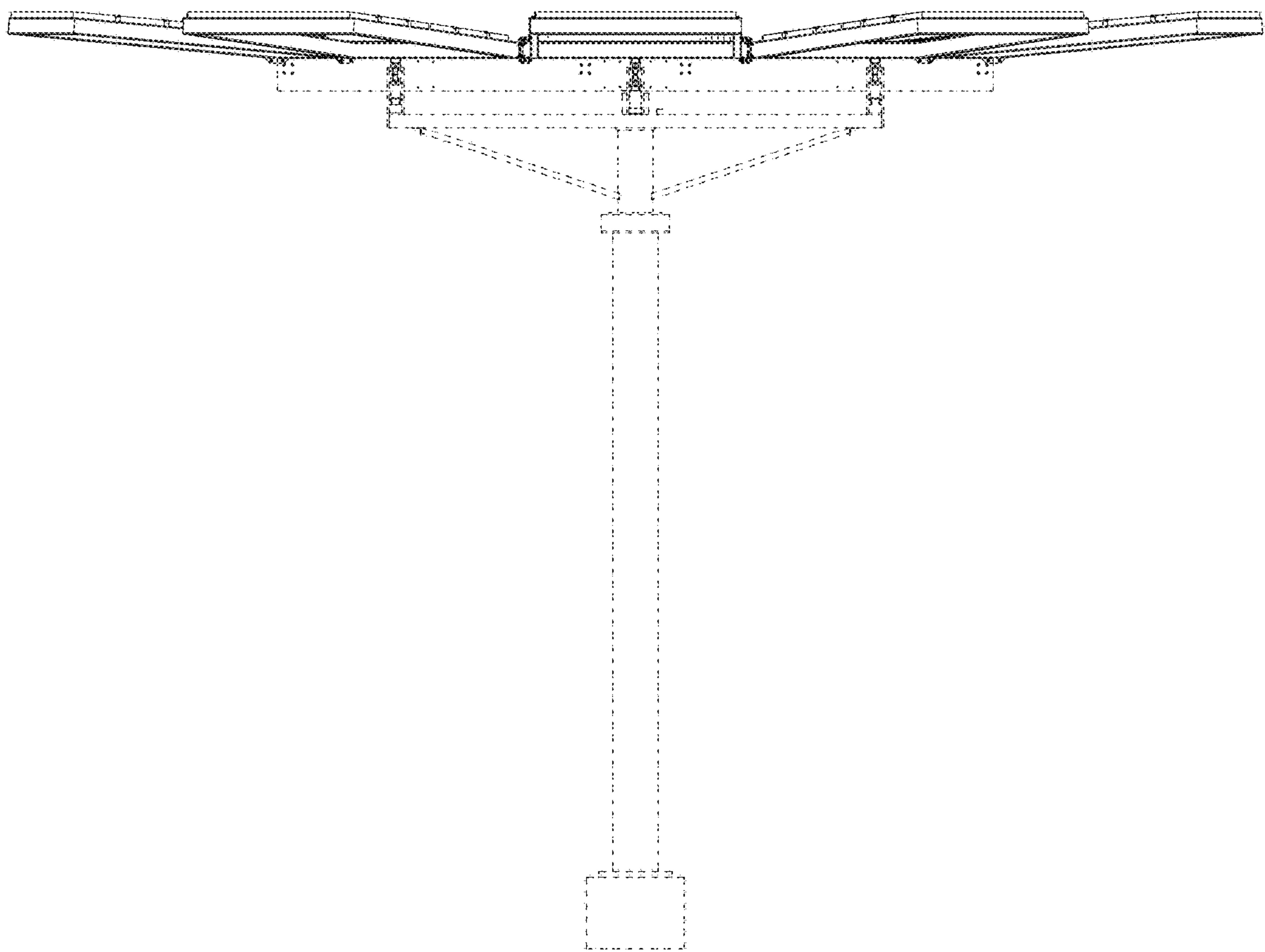

FIG. 3

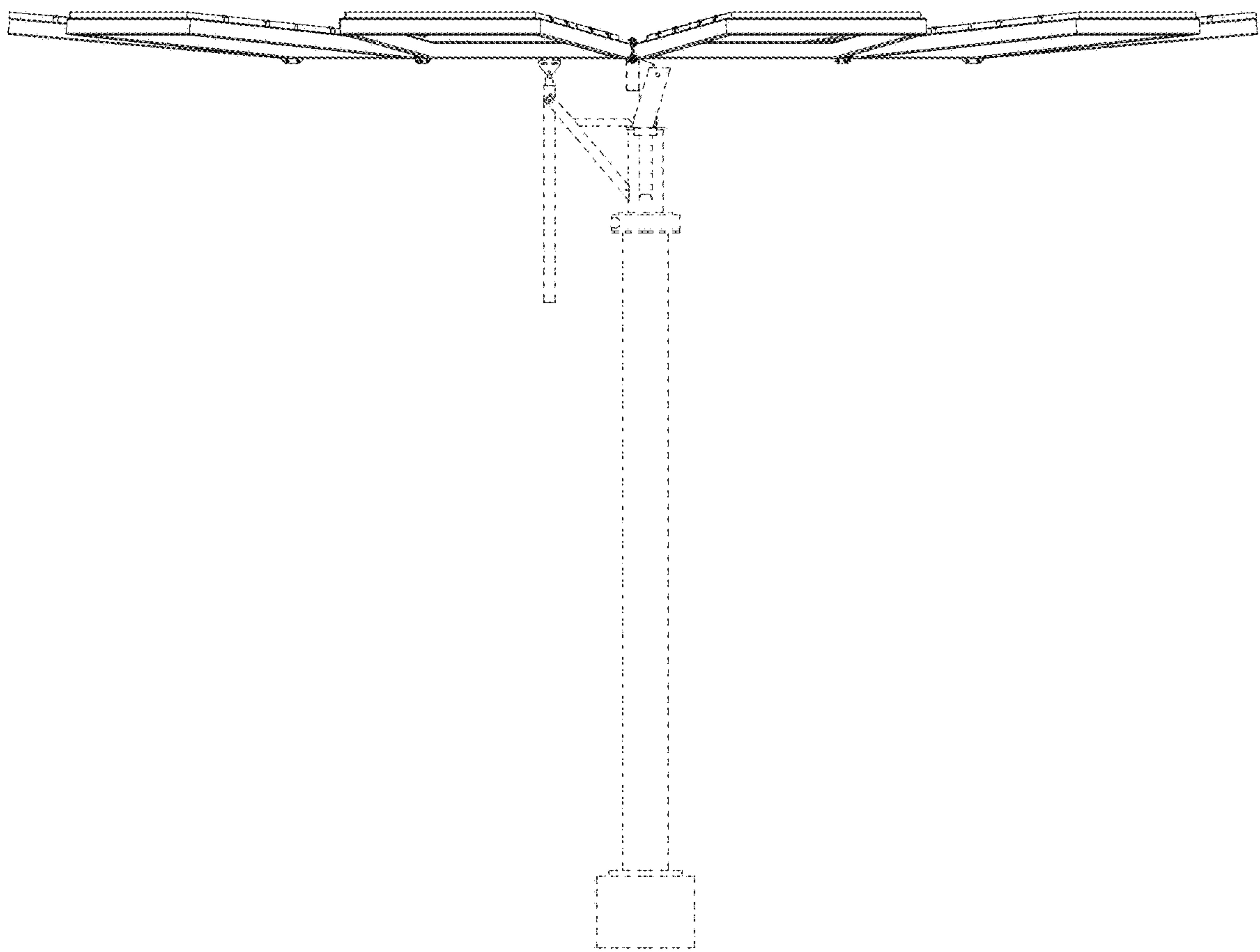

FIG. 4

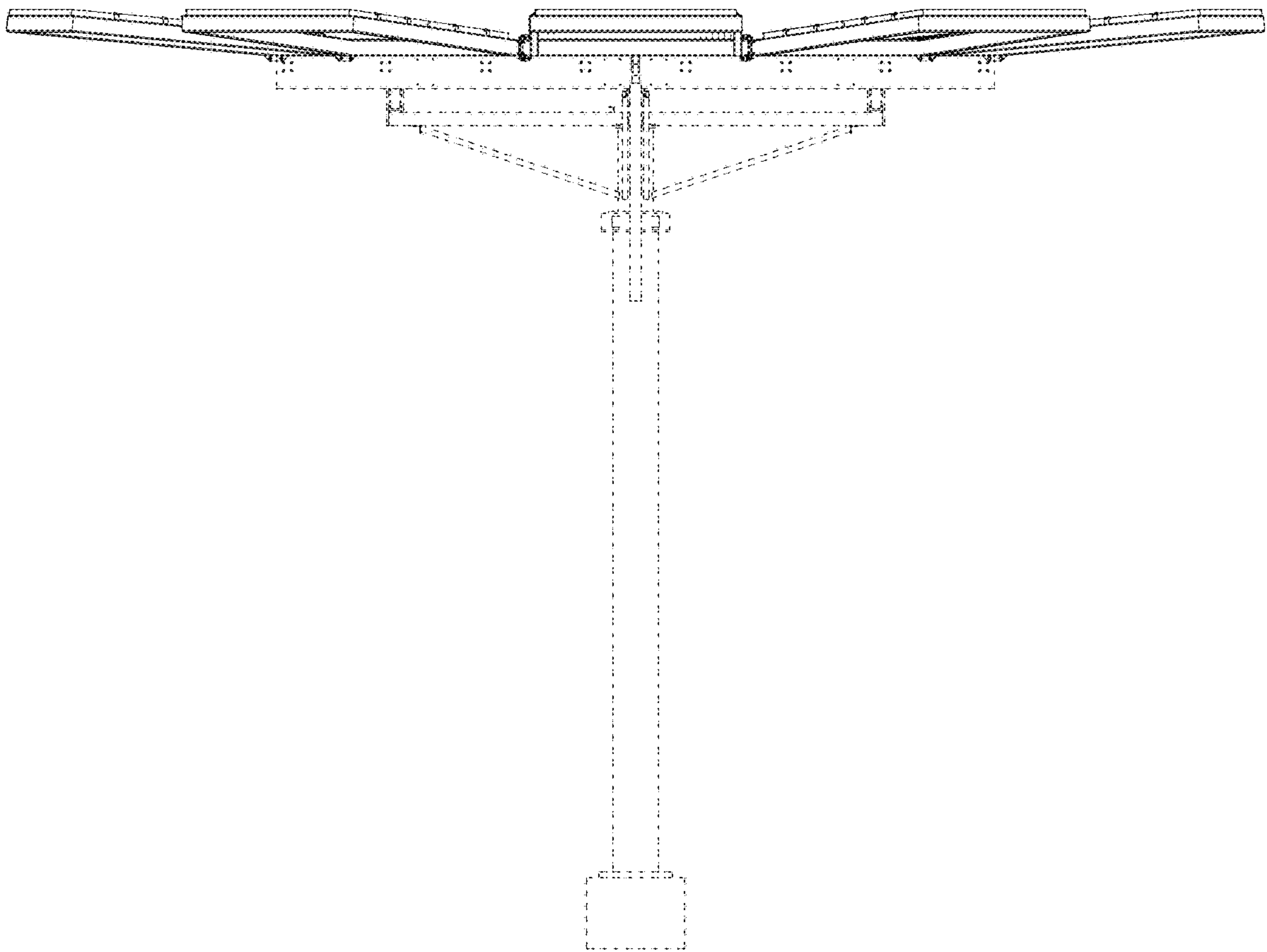

FIG. 5

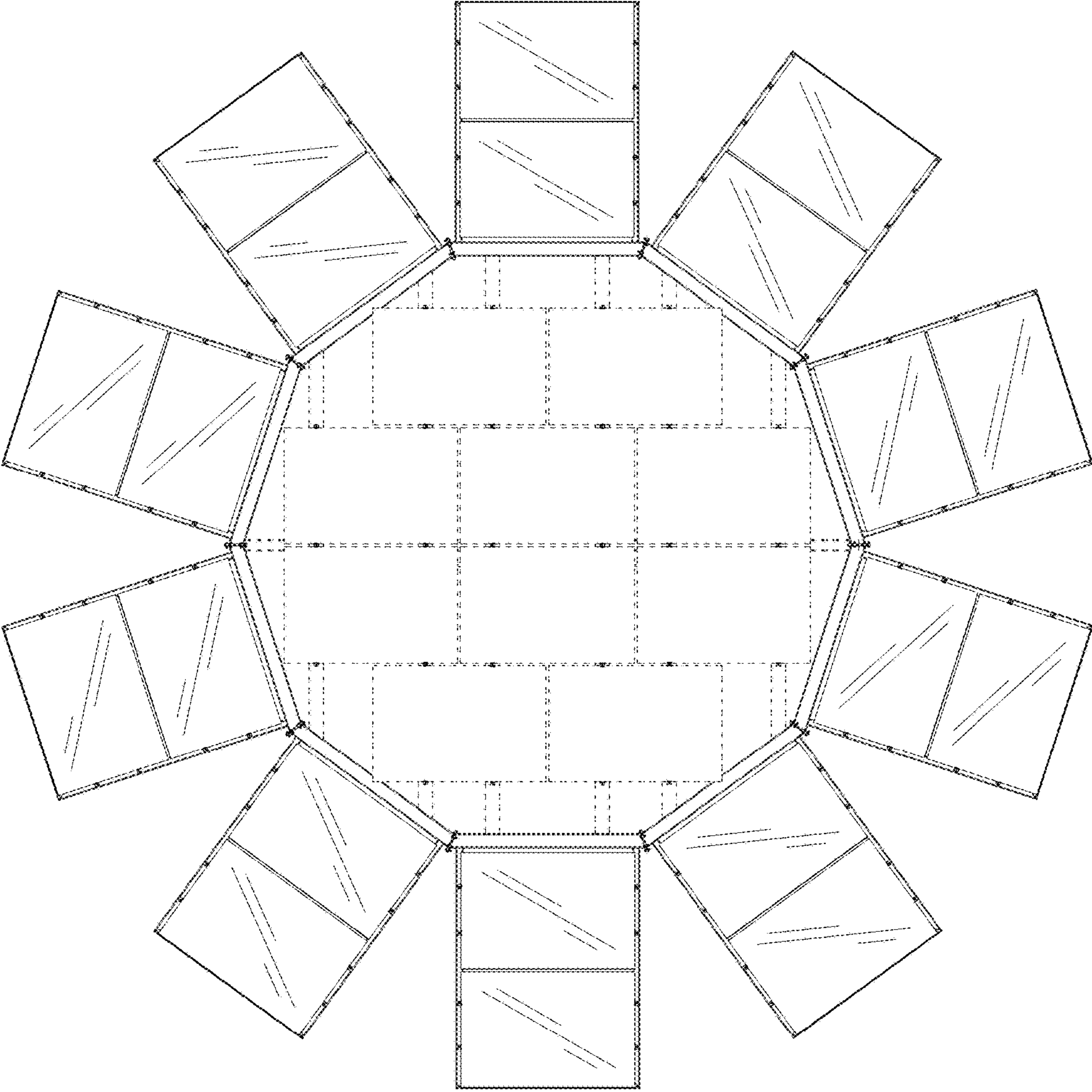

FIG. 6

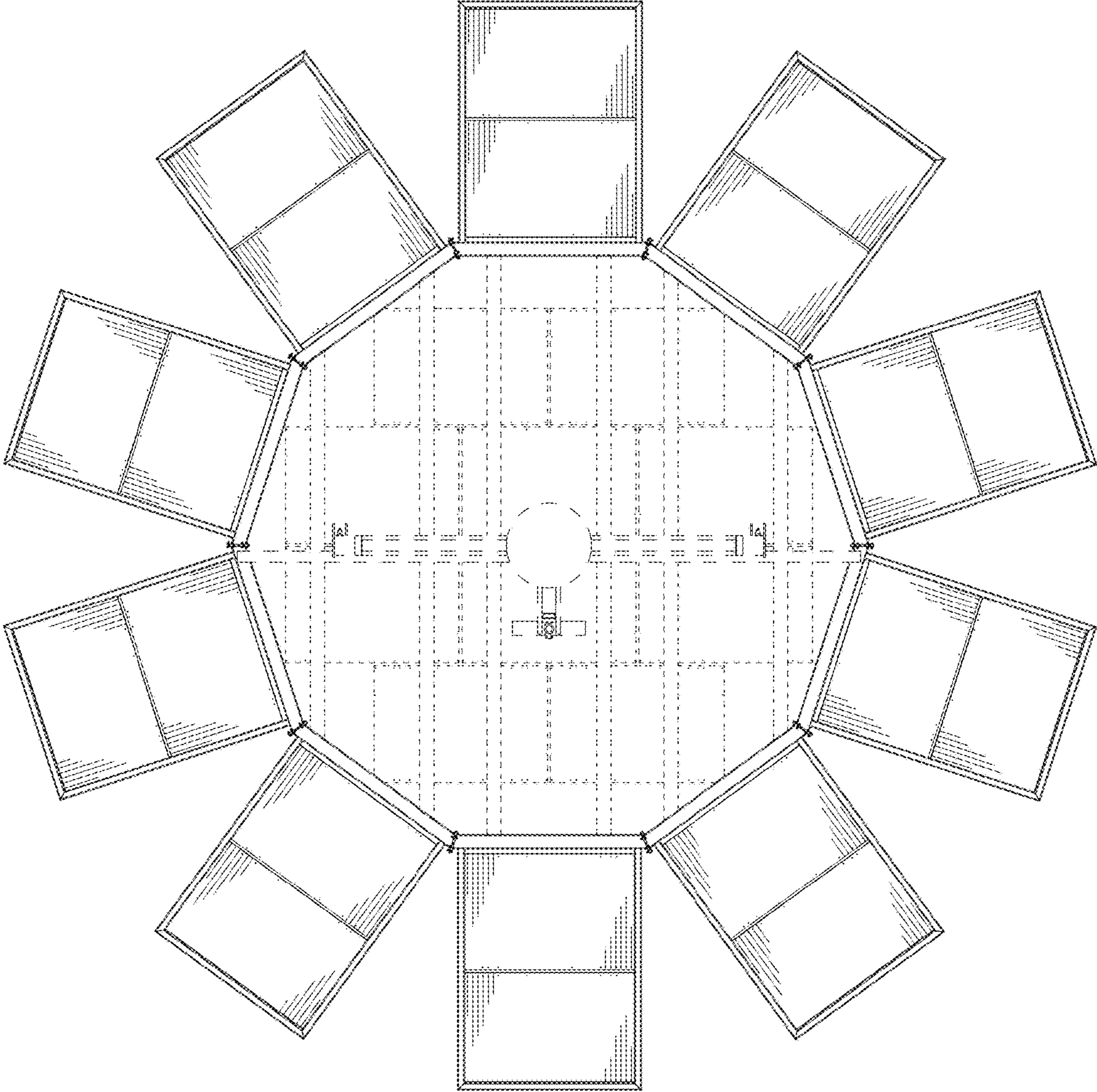

FIG. 7

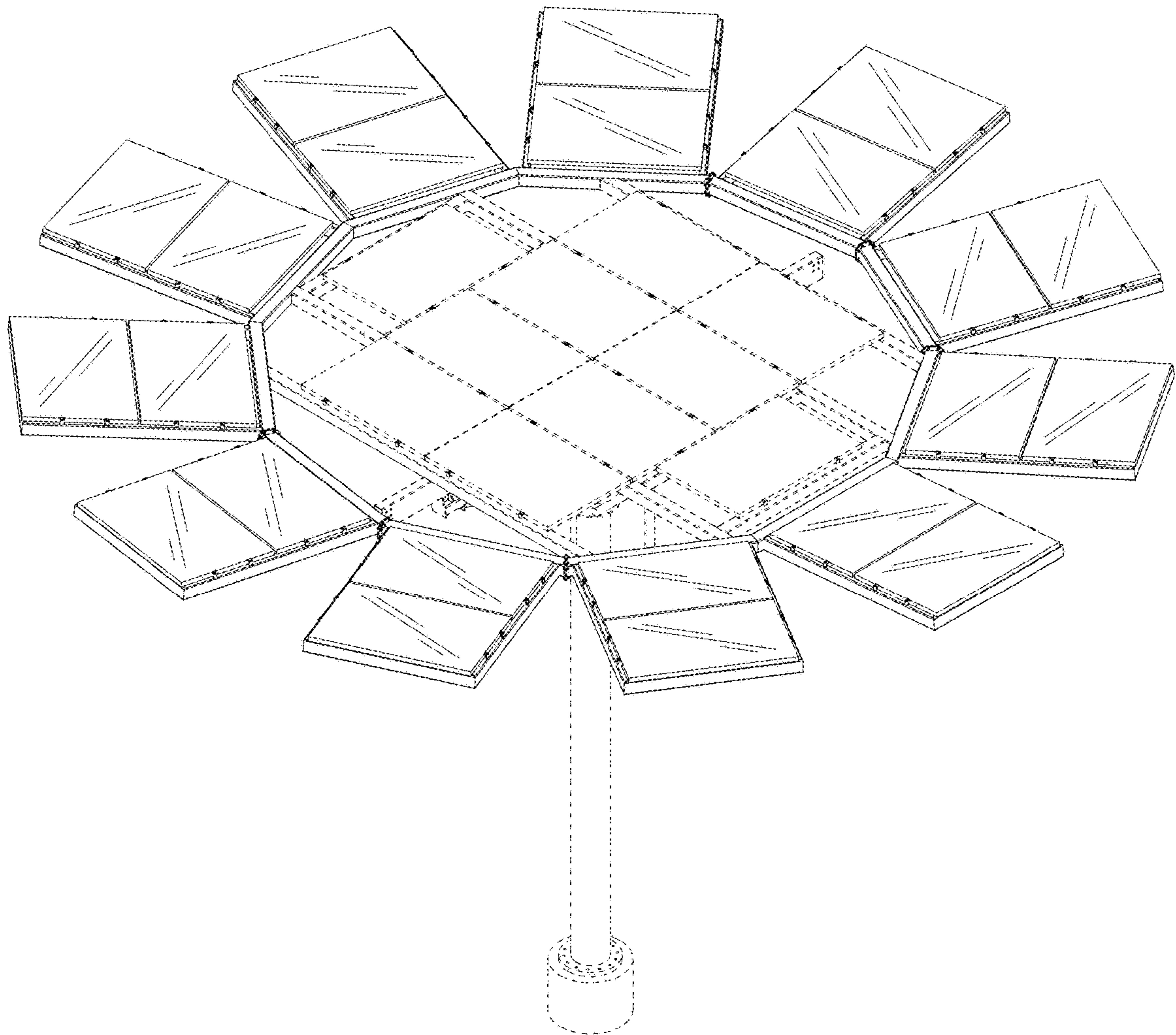

FIG. 8

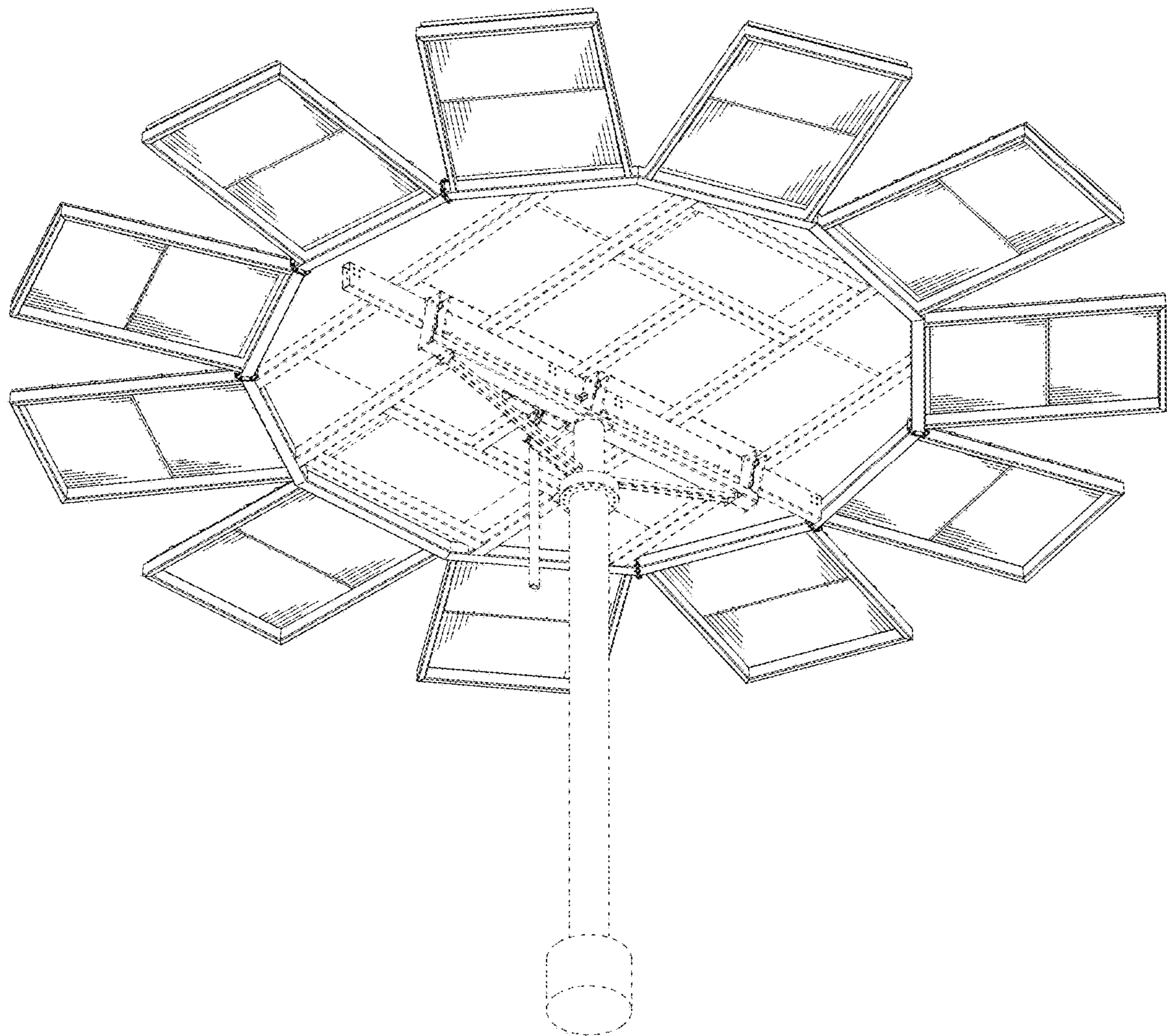

FIG. 9

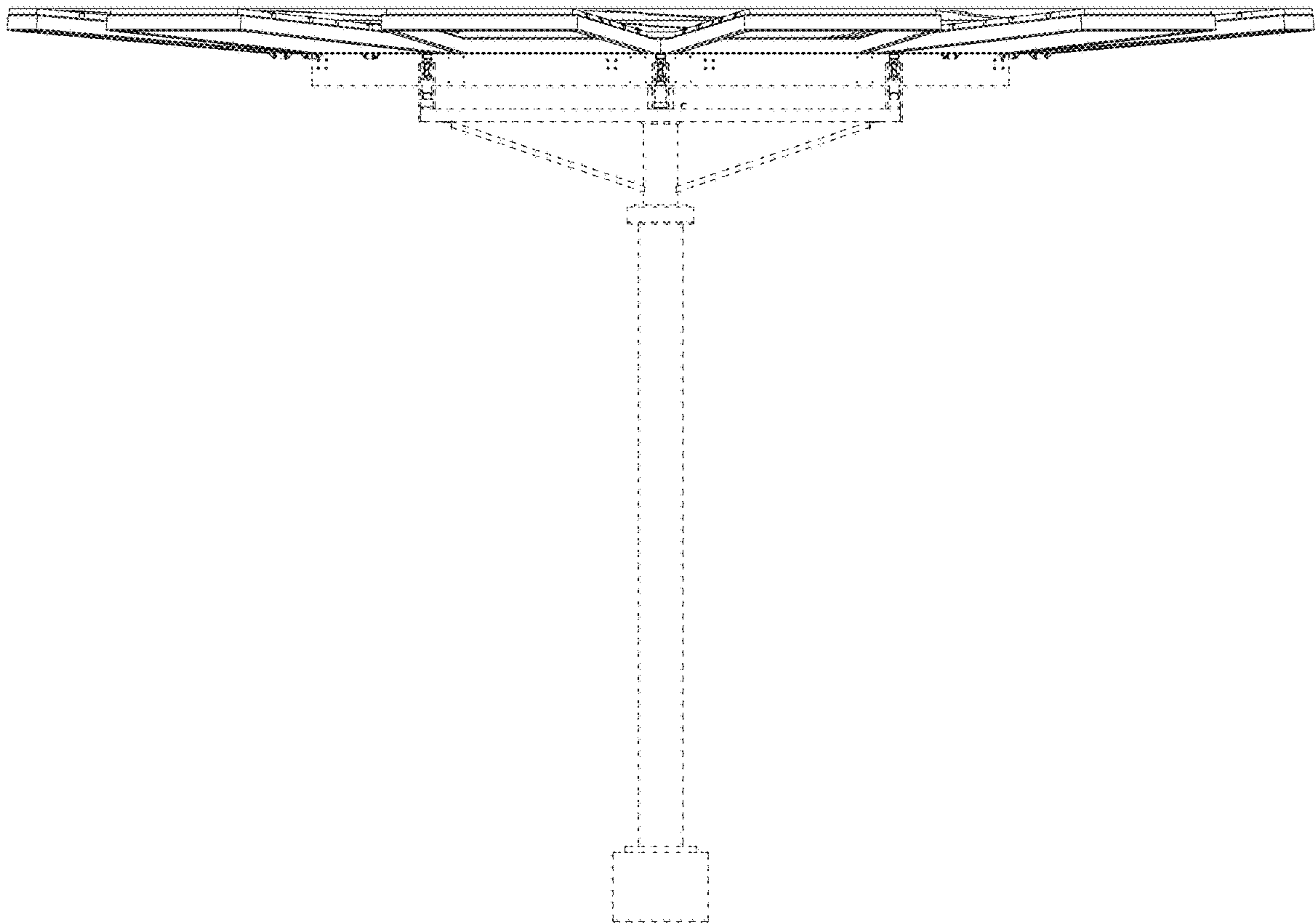

FIG. 10

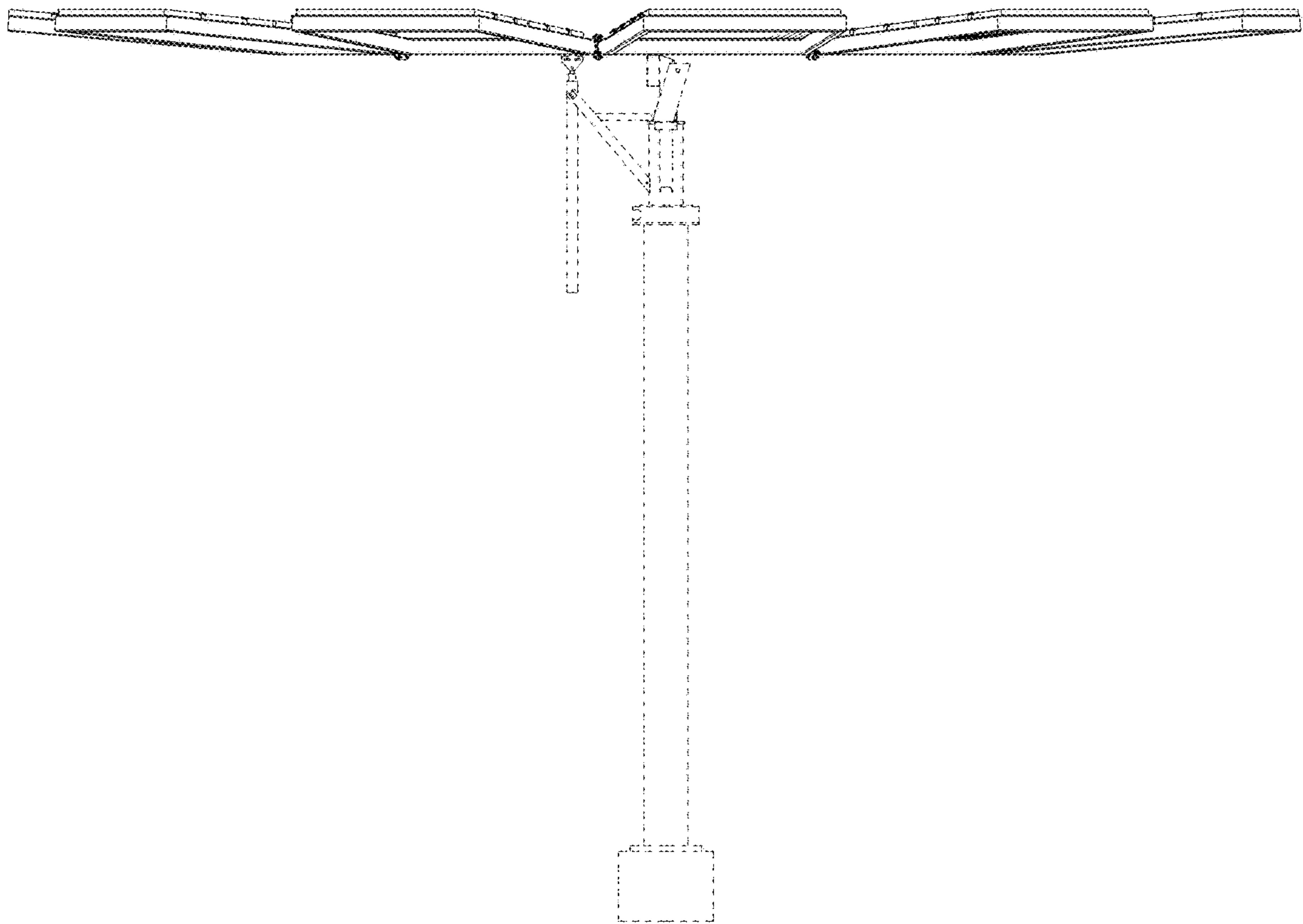

FIG. 11

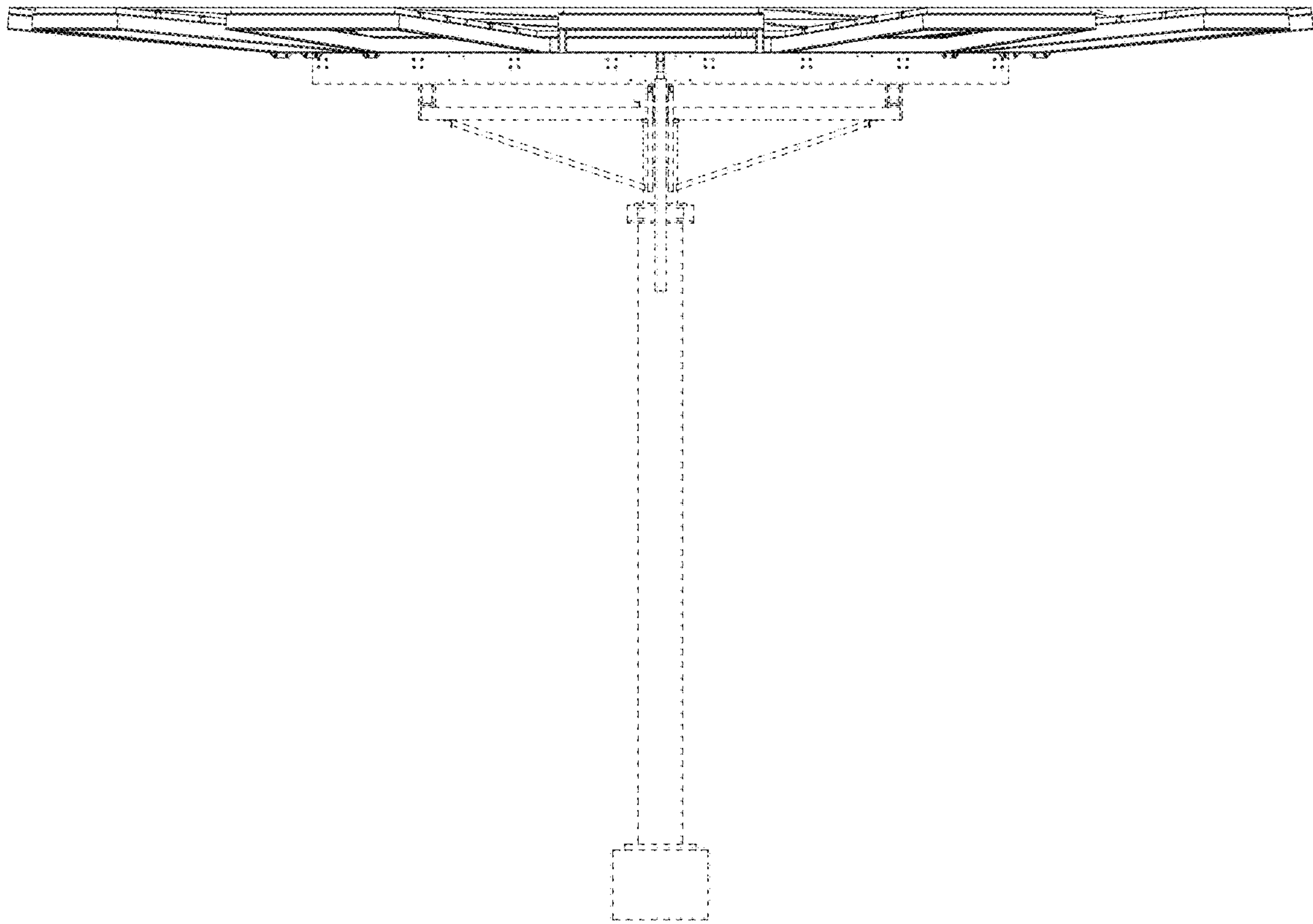

FIG. 12

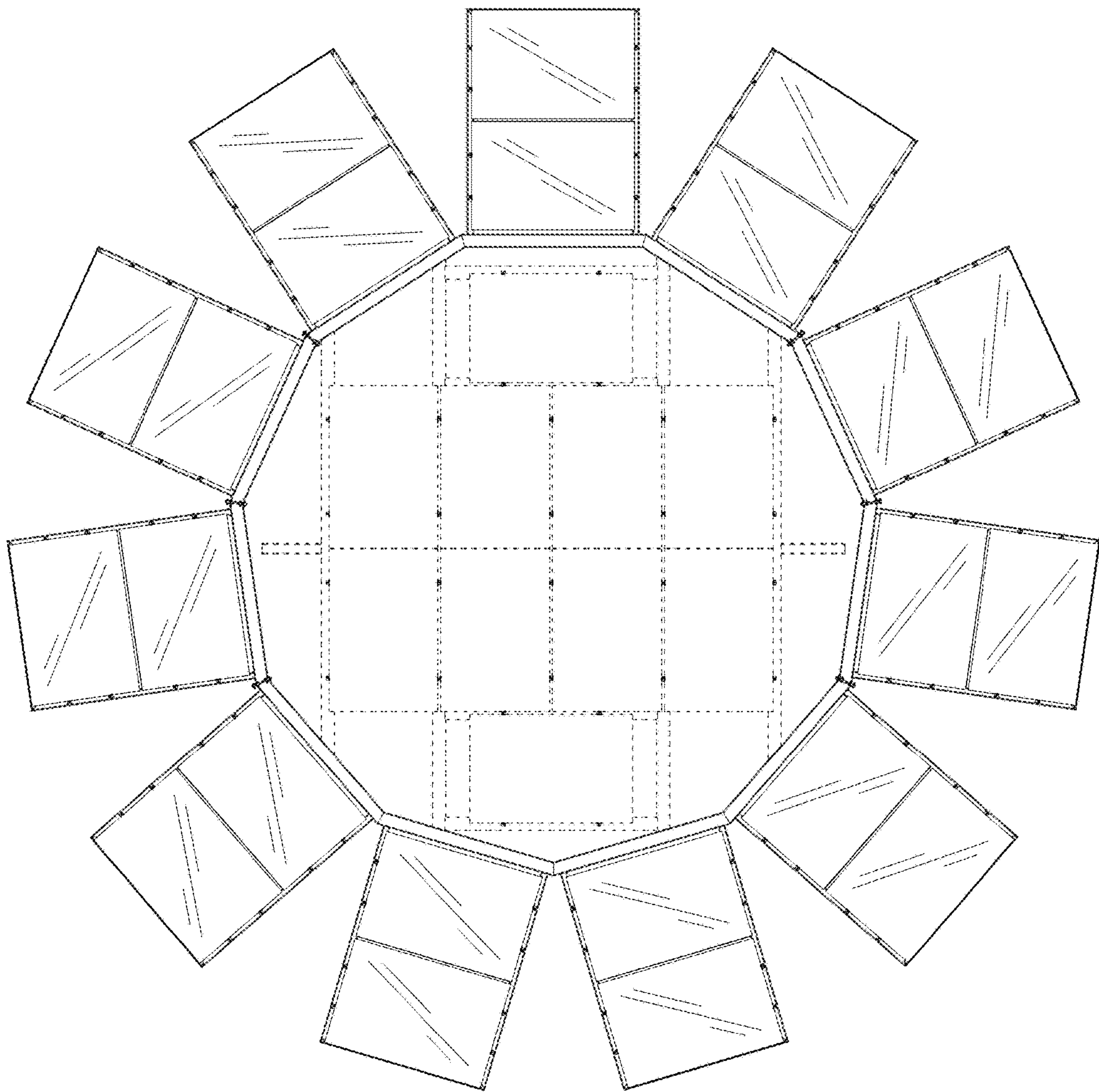

FIG. 13

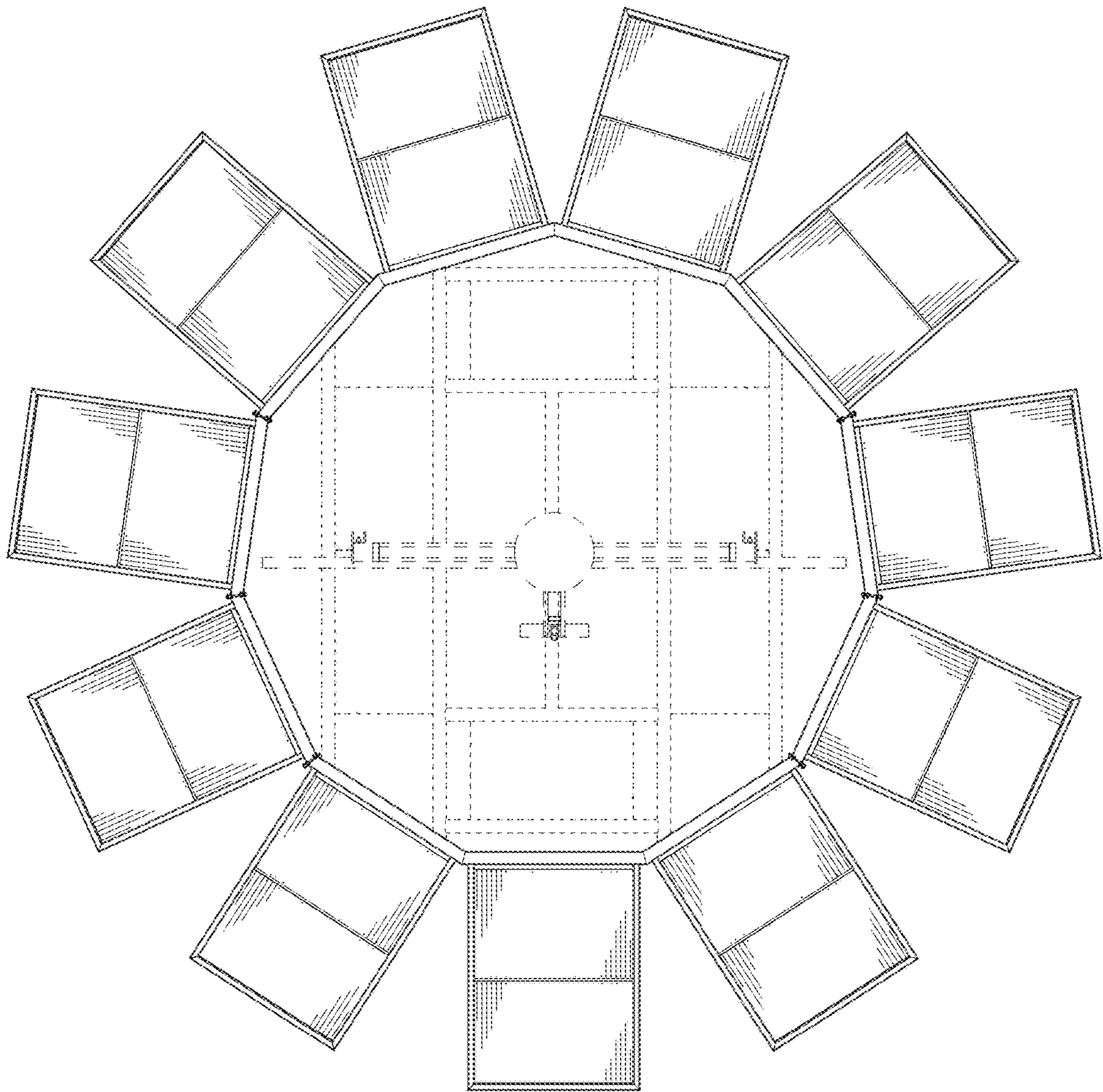

FIG. 14

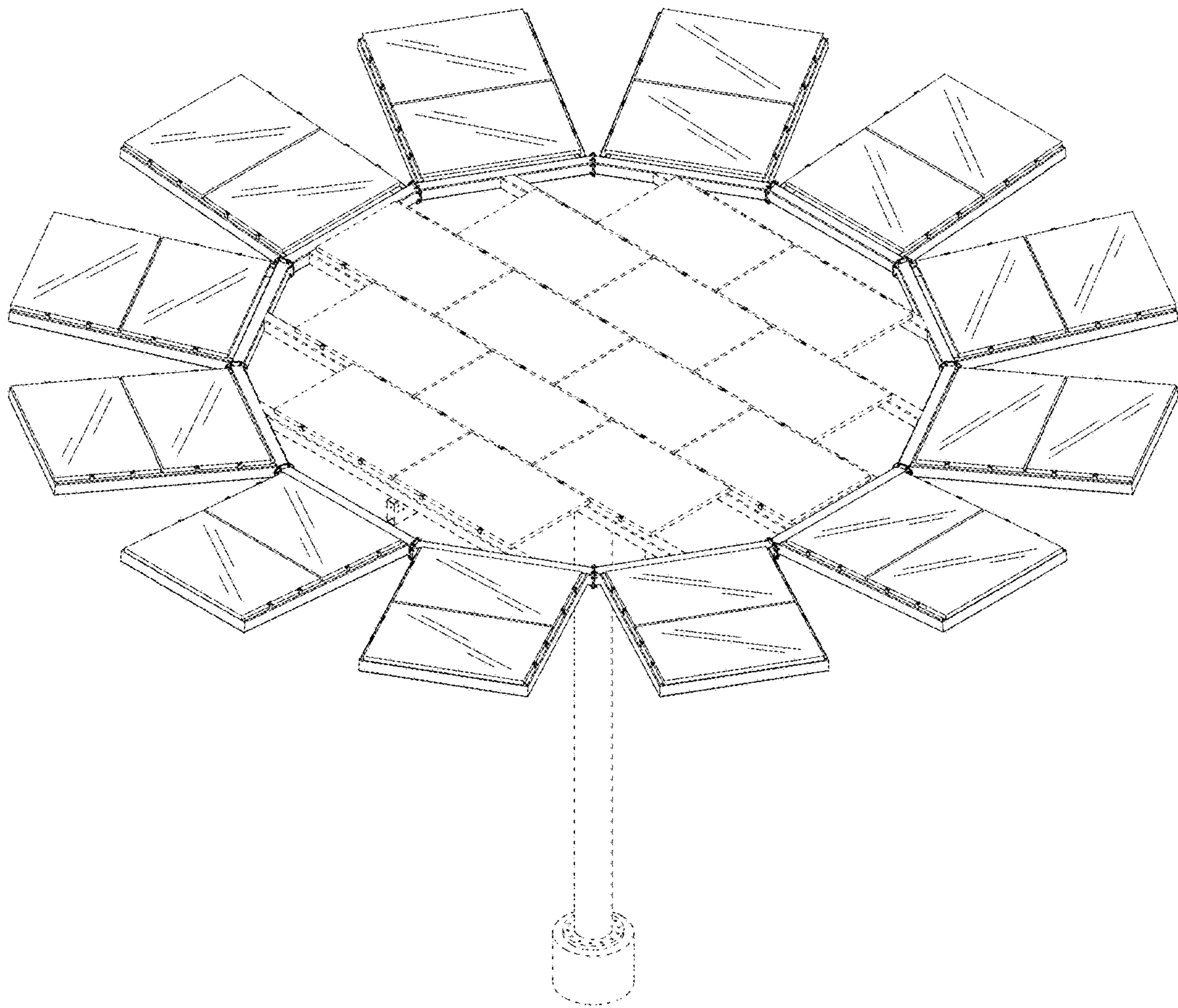

FIG. 15

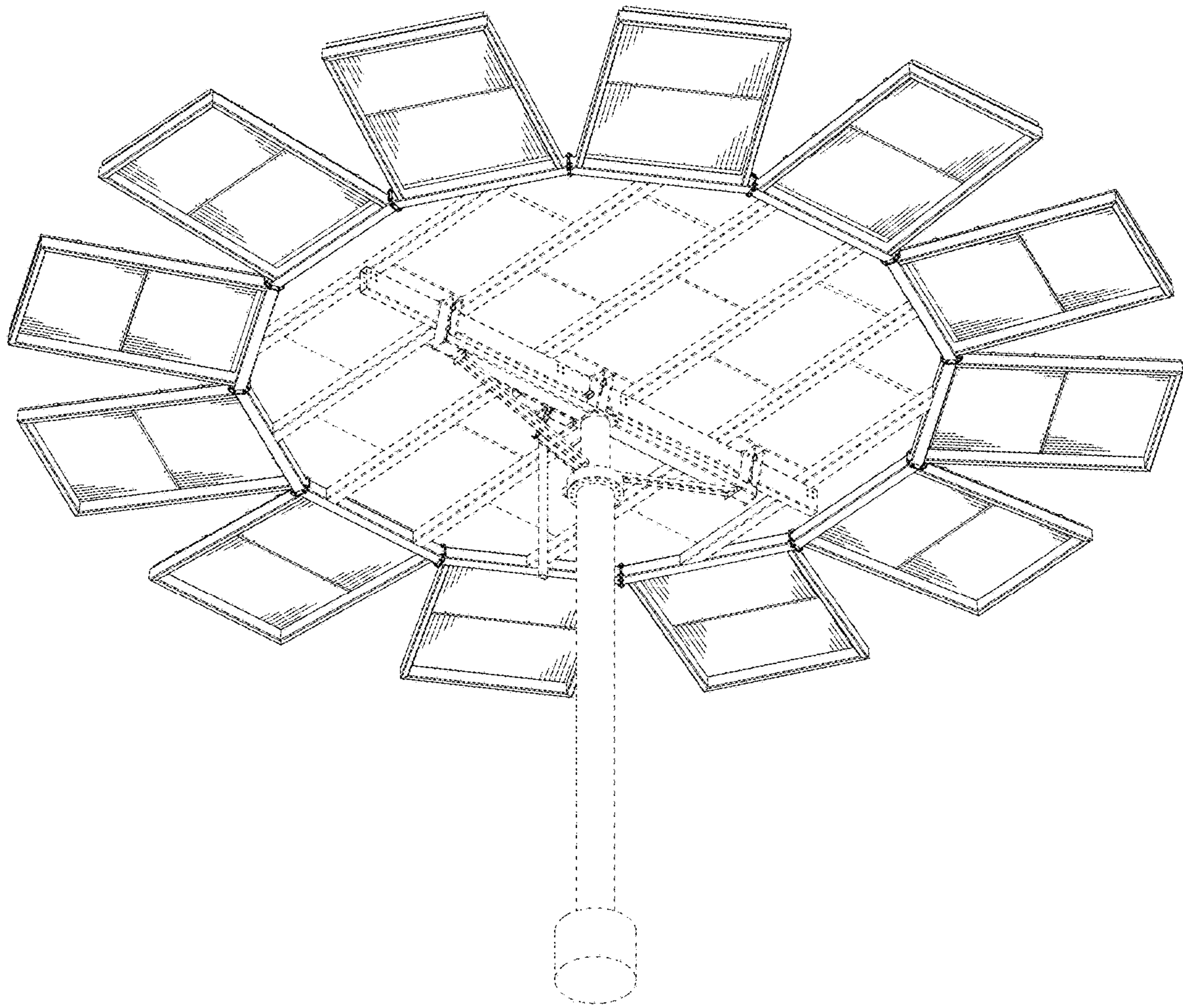

FIG. 16

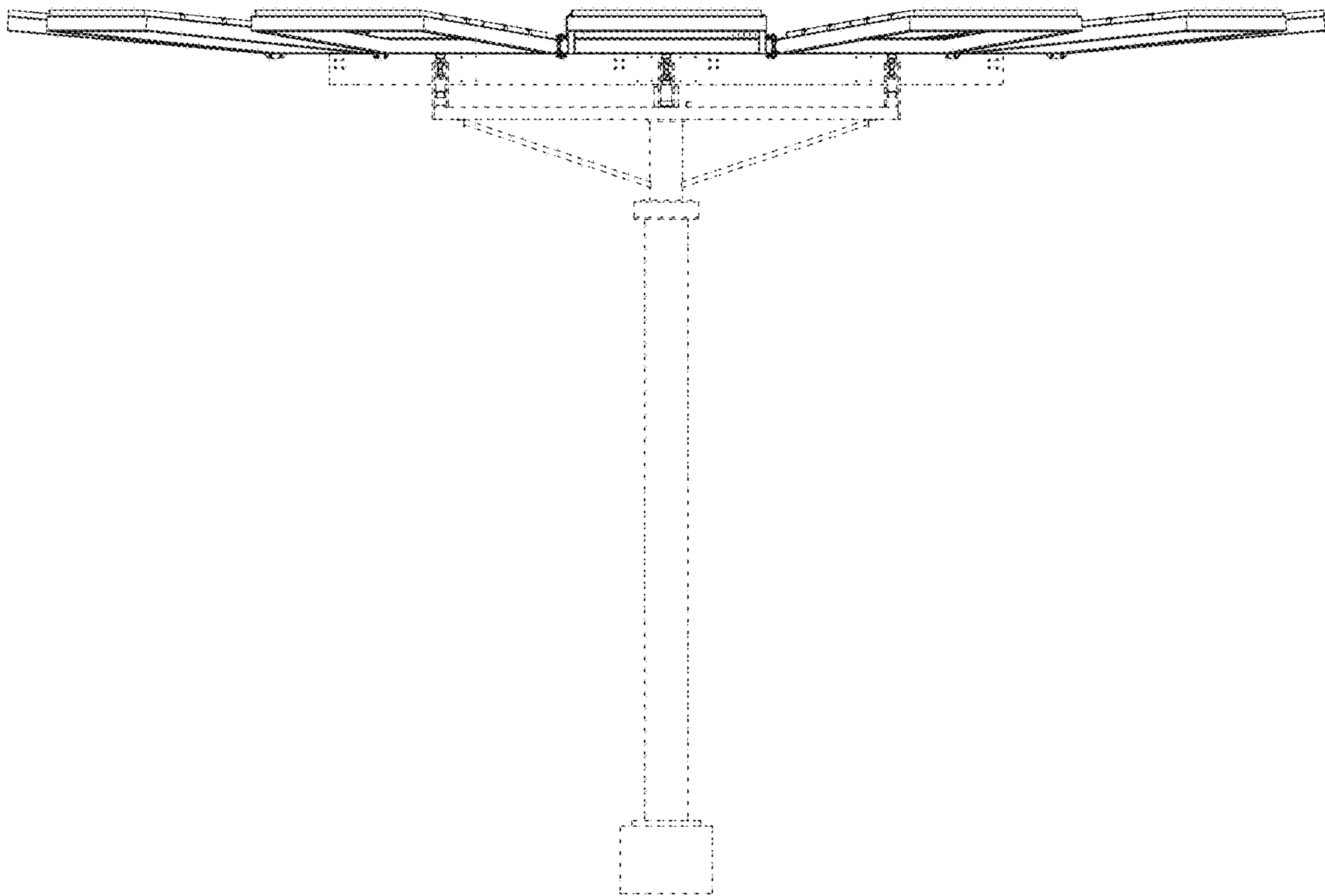

FIG. 17

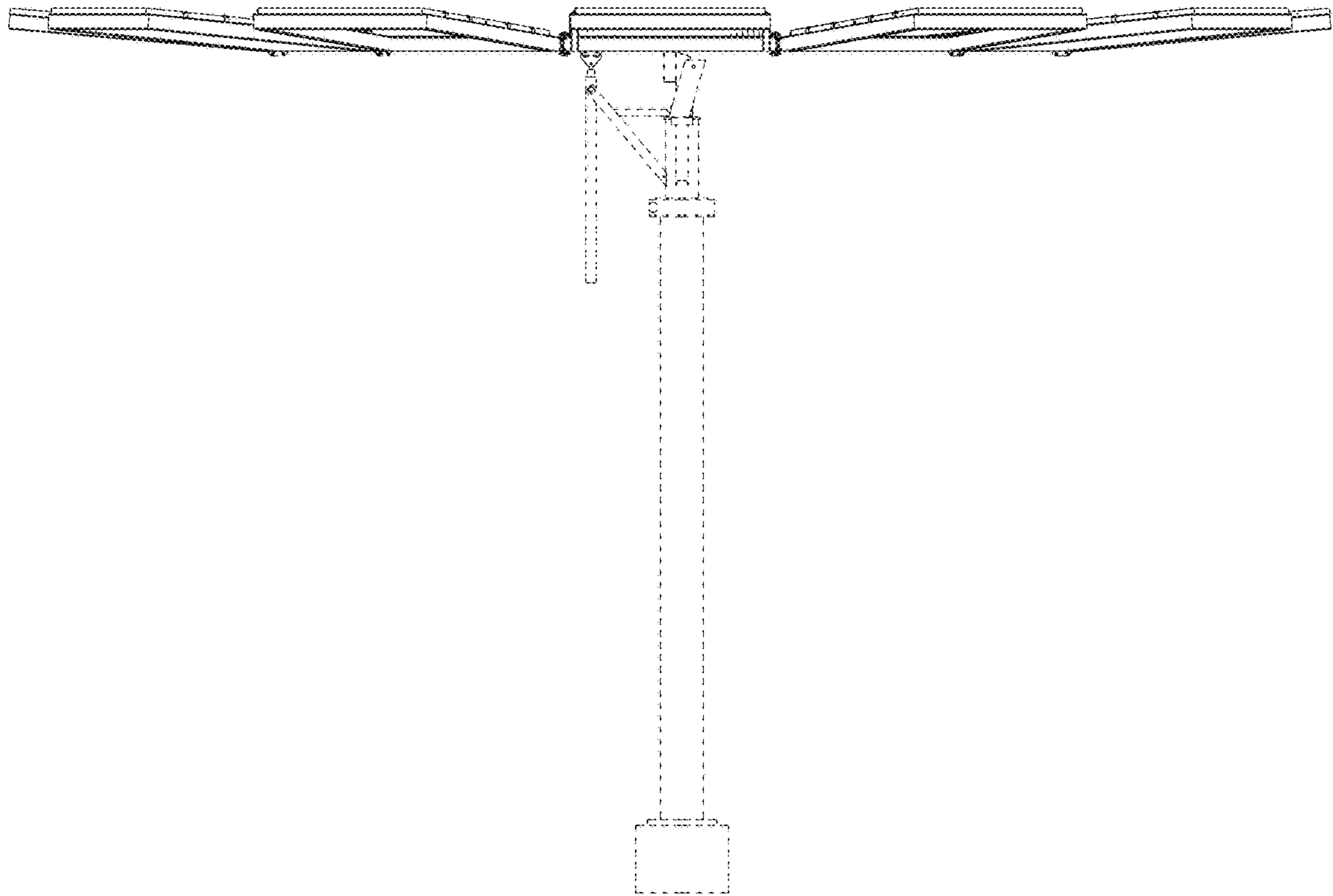

FIG. 18

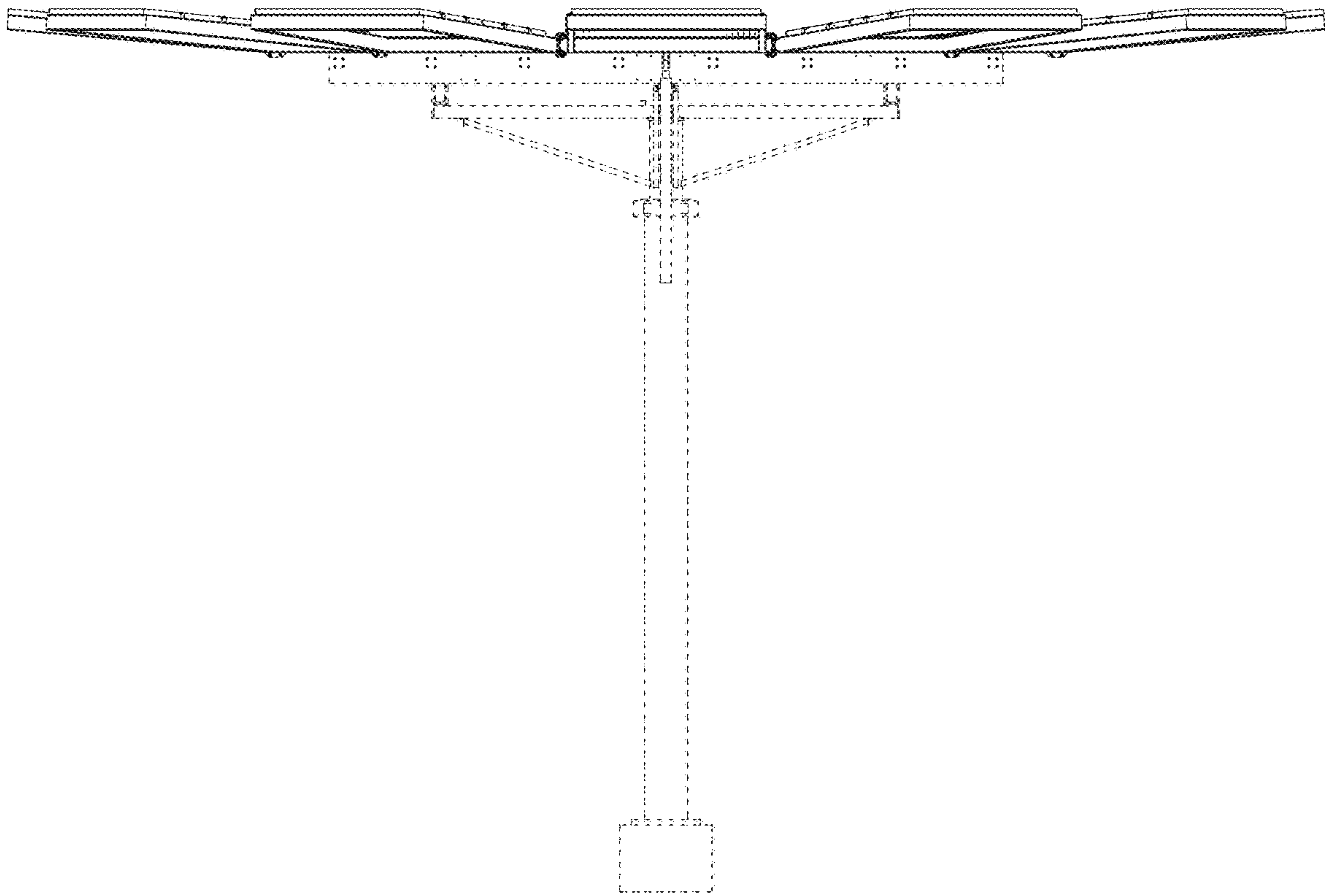

FIG. 19

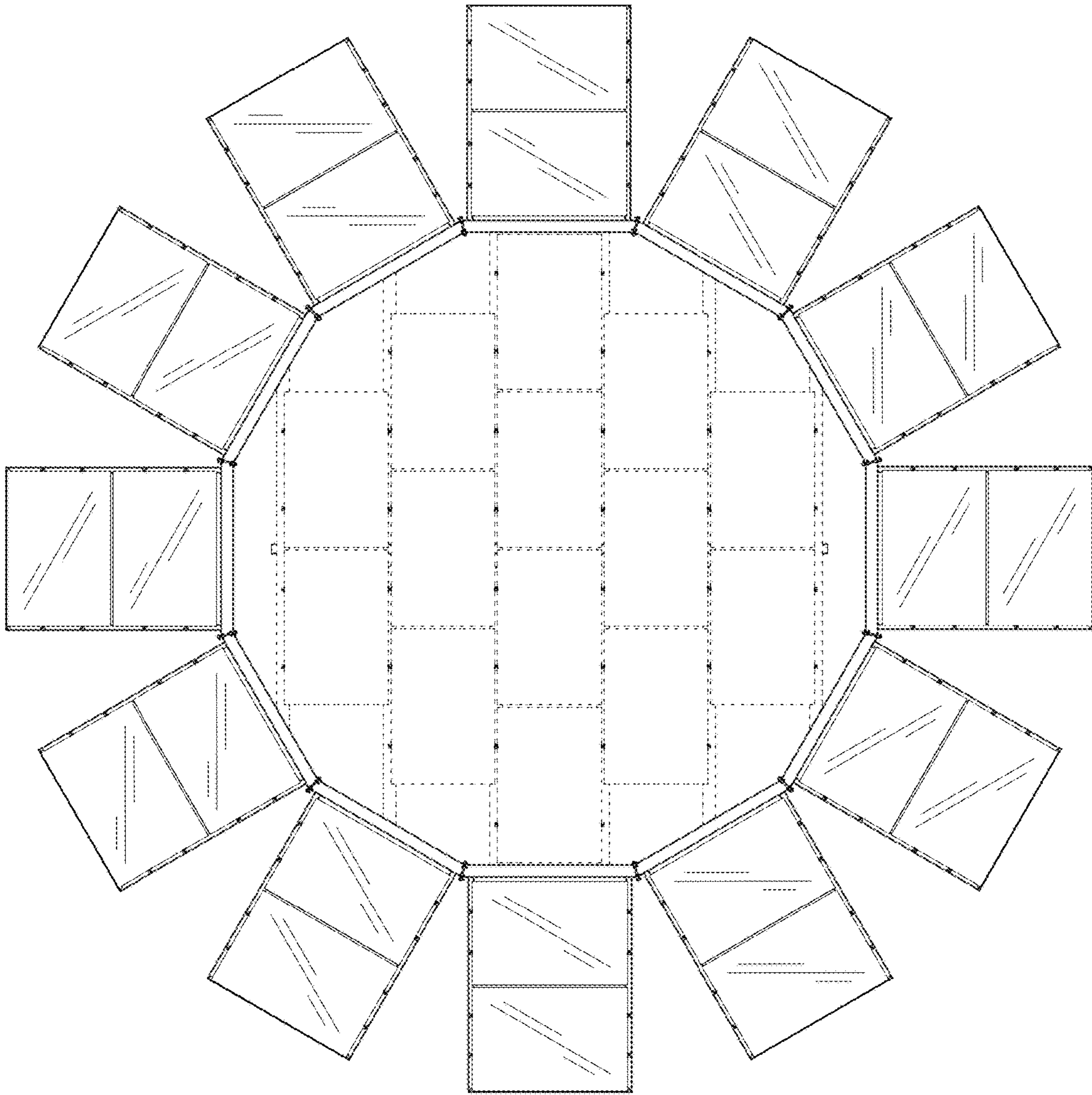

FIG. 20

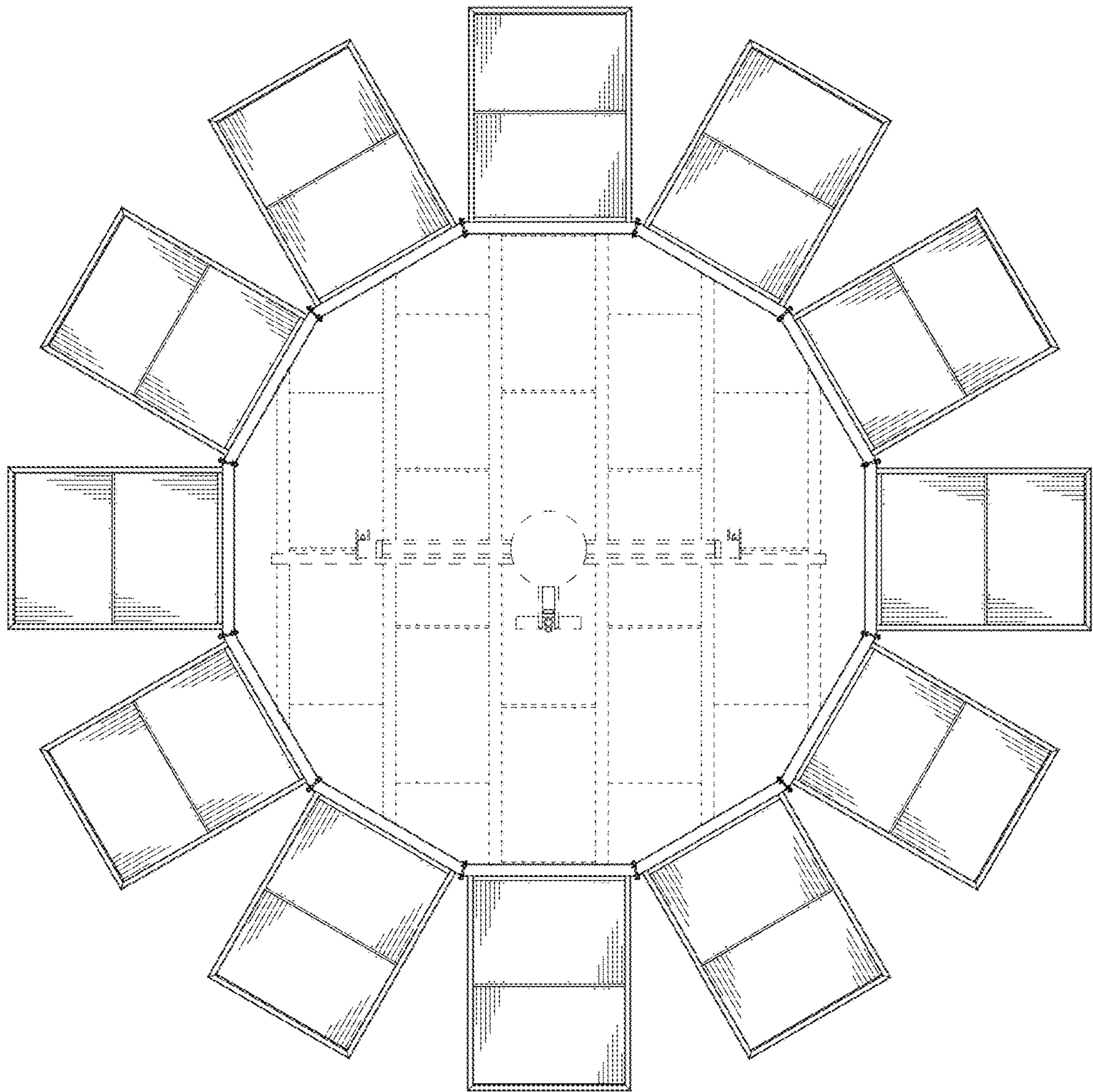

FIG. 21

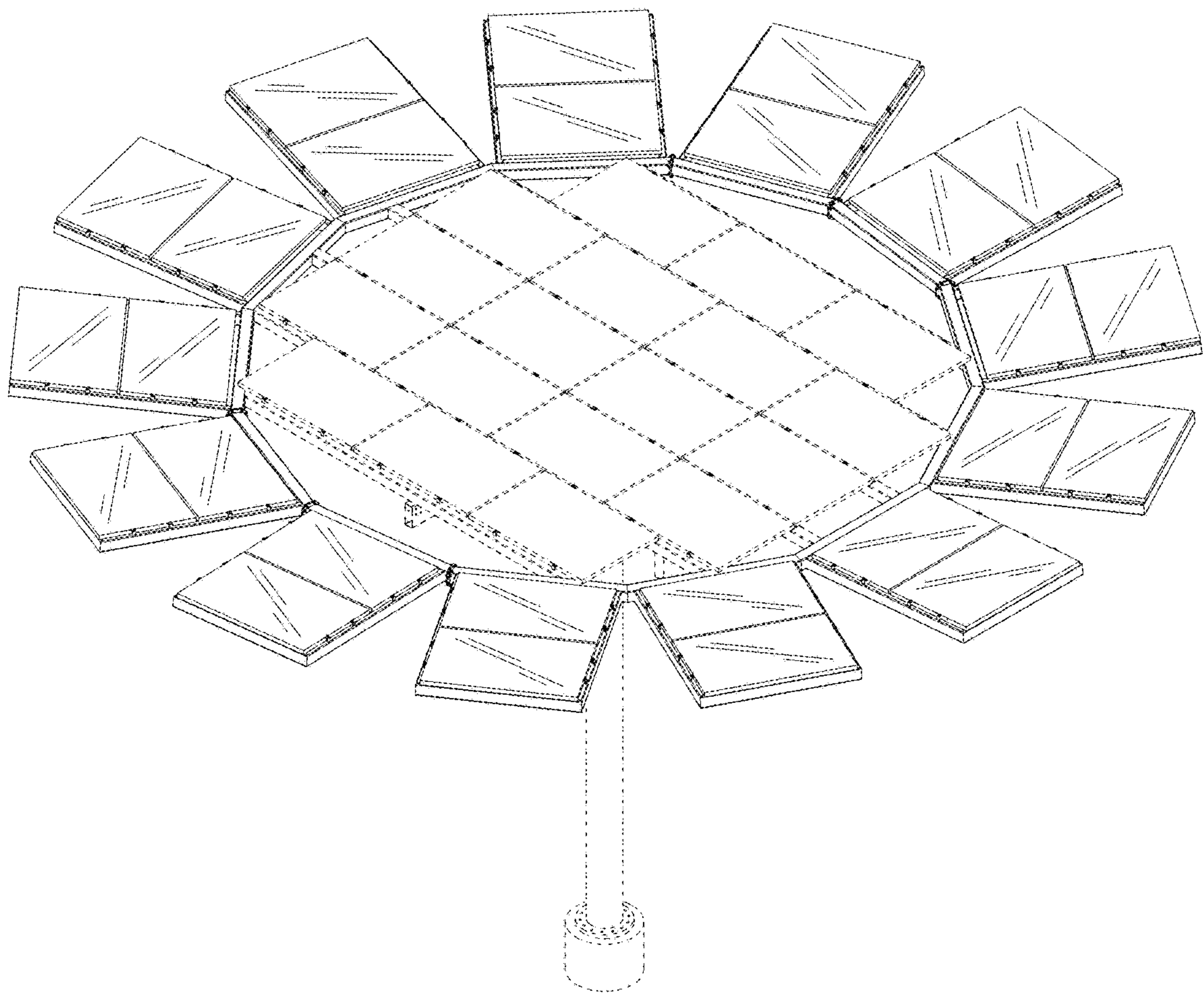

FIG. 22

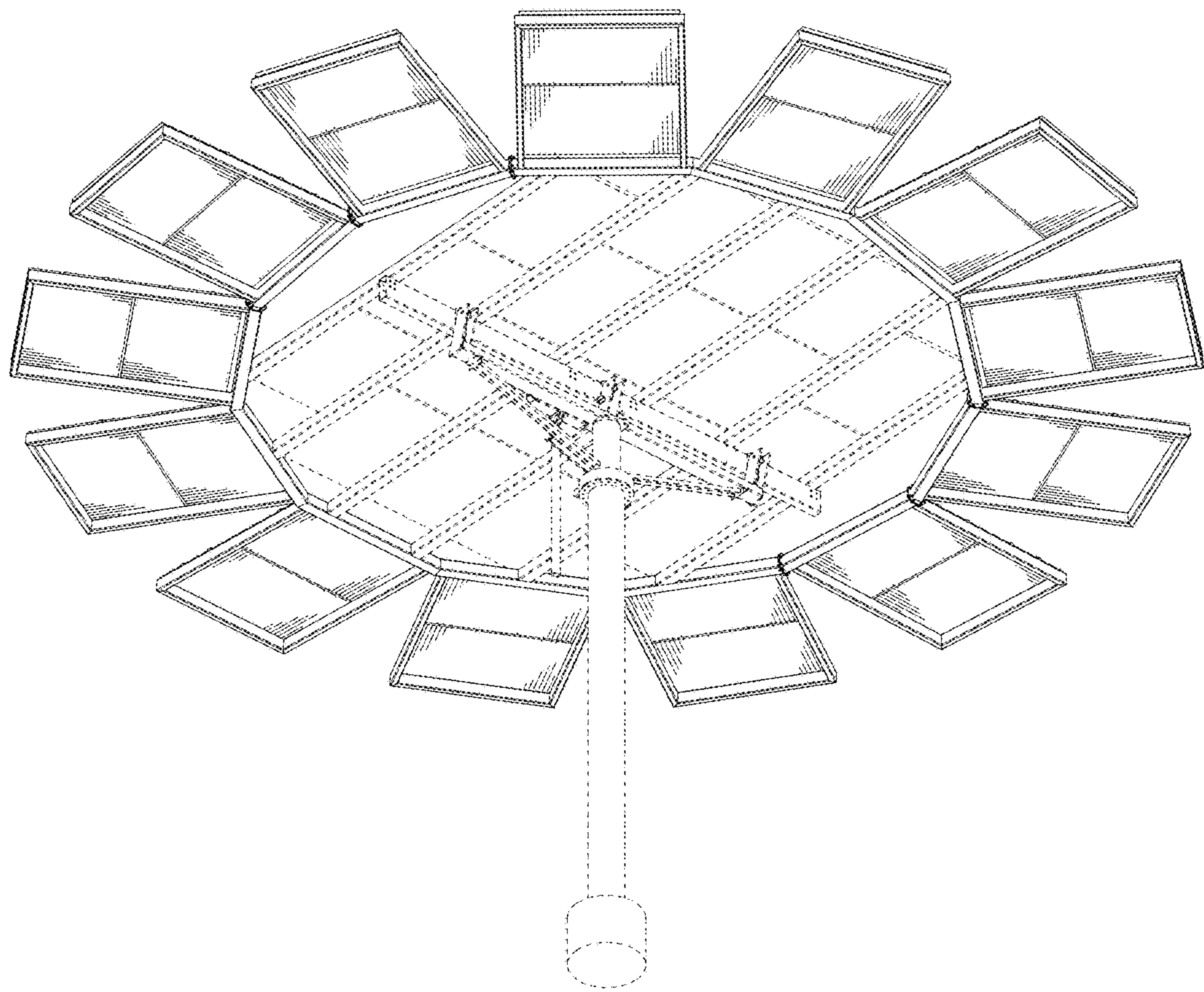

FIG. 23

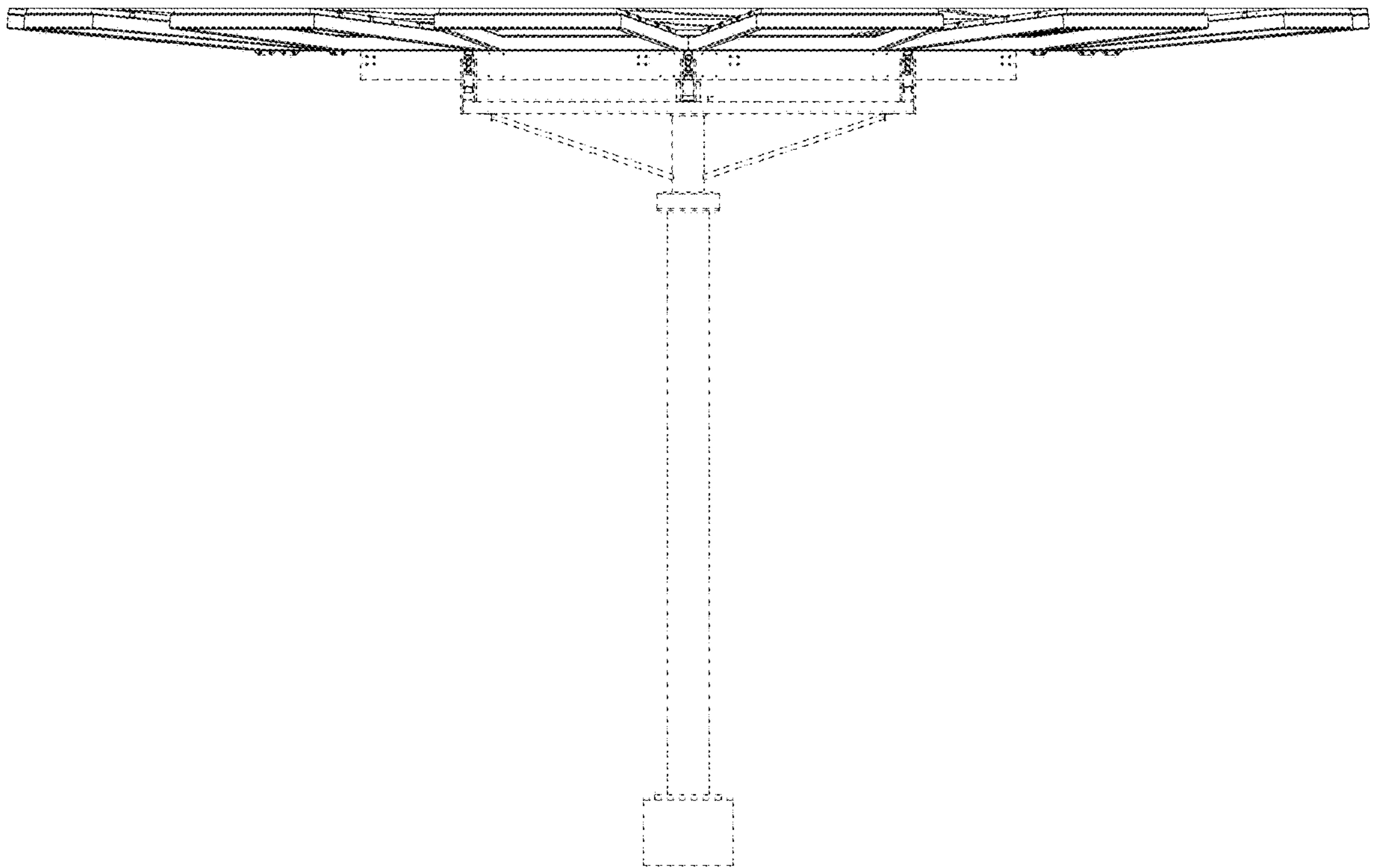

FIG. 24

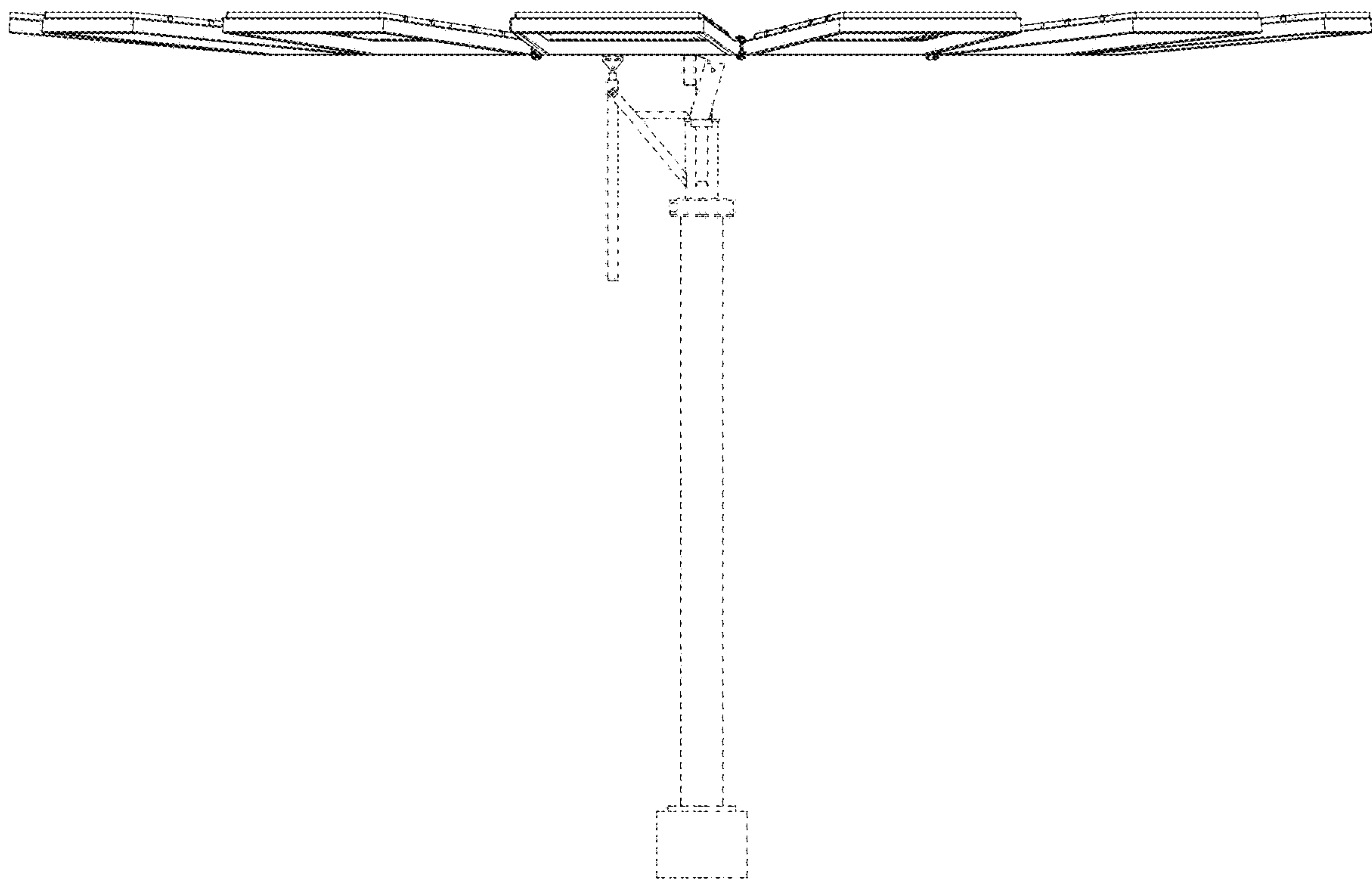

FIG. 25

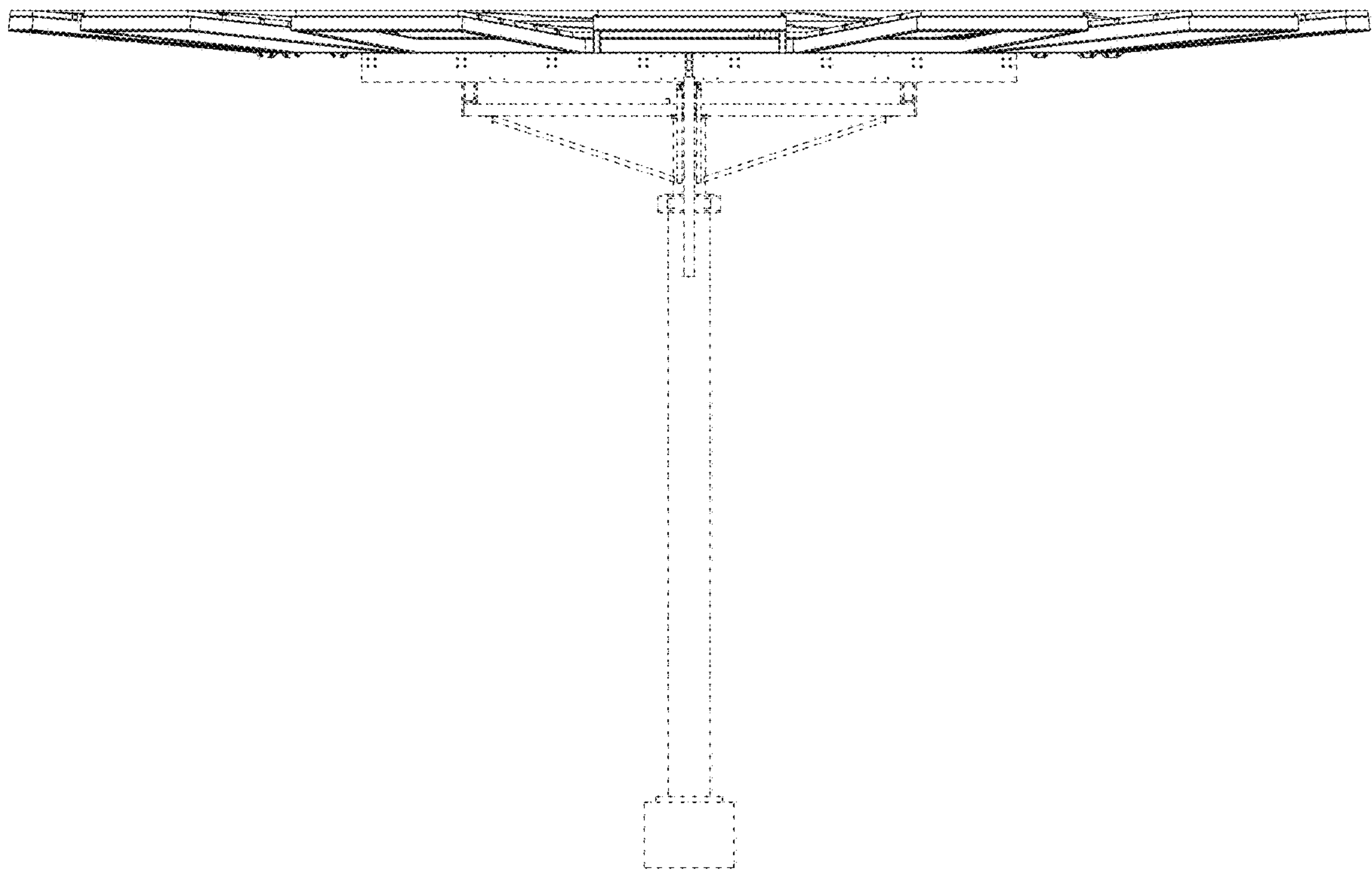

FIG. 26

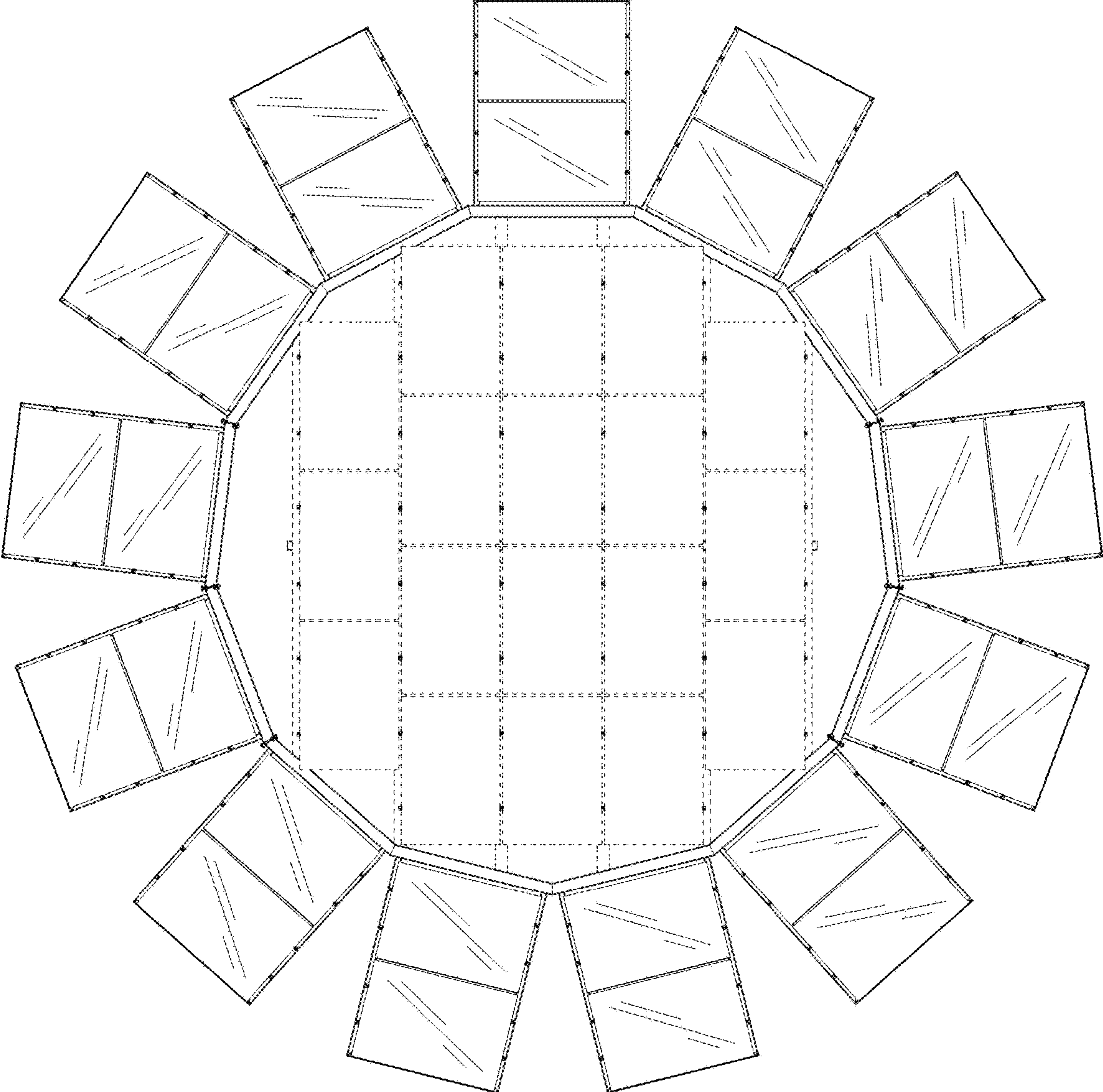

FIG. 27

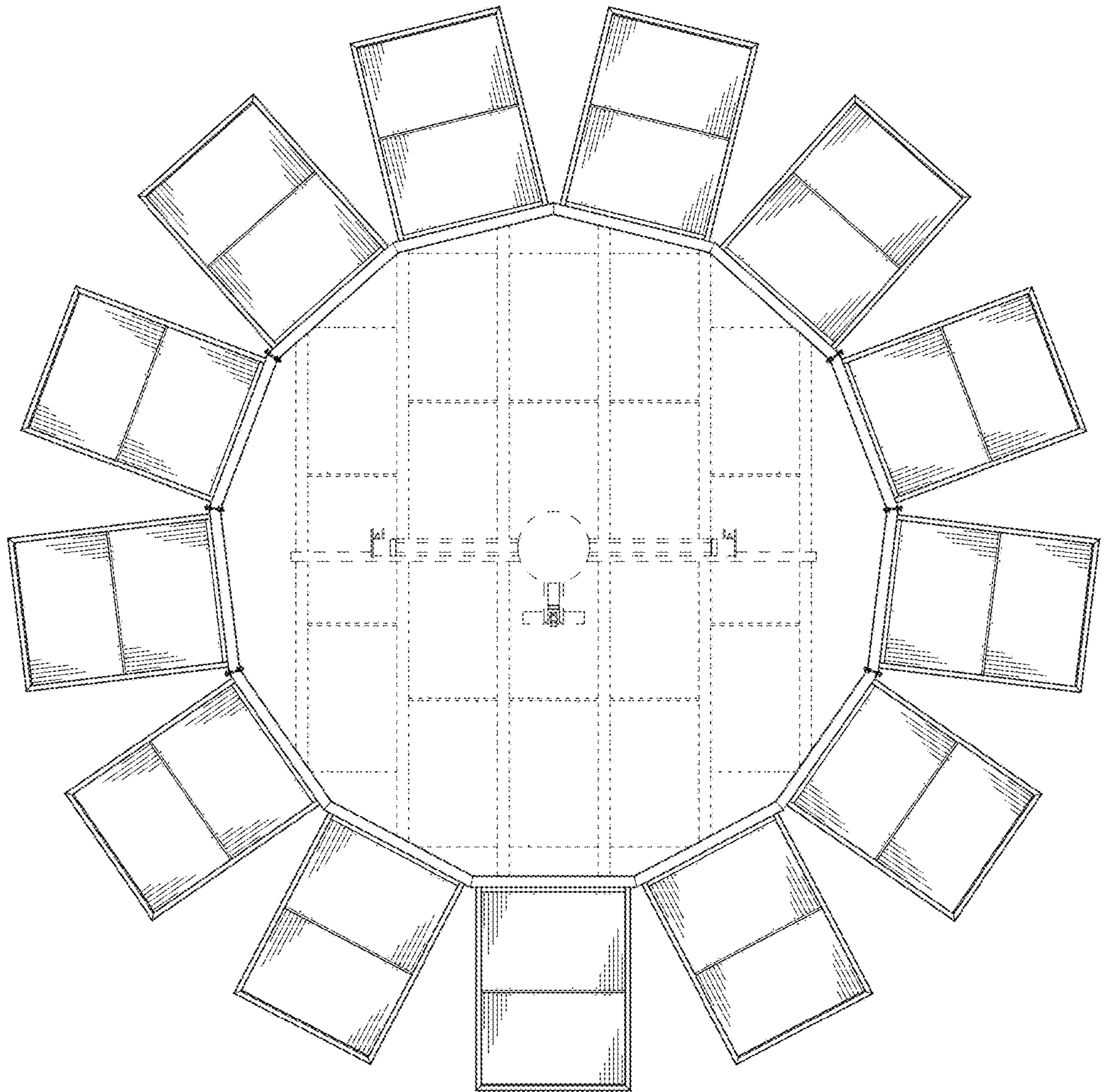

FIG. 28

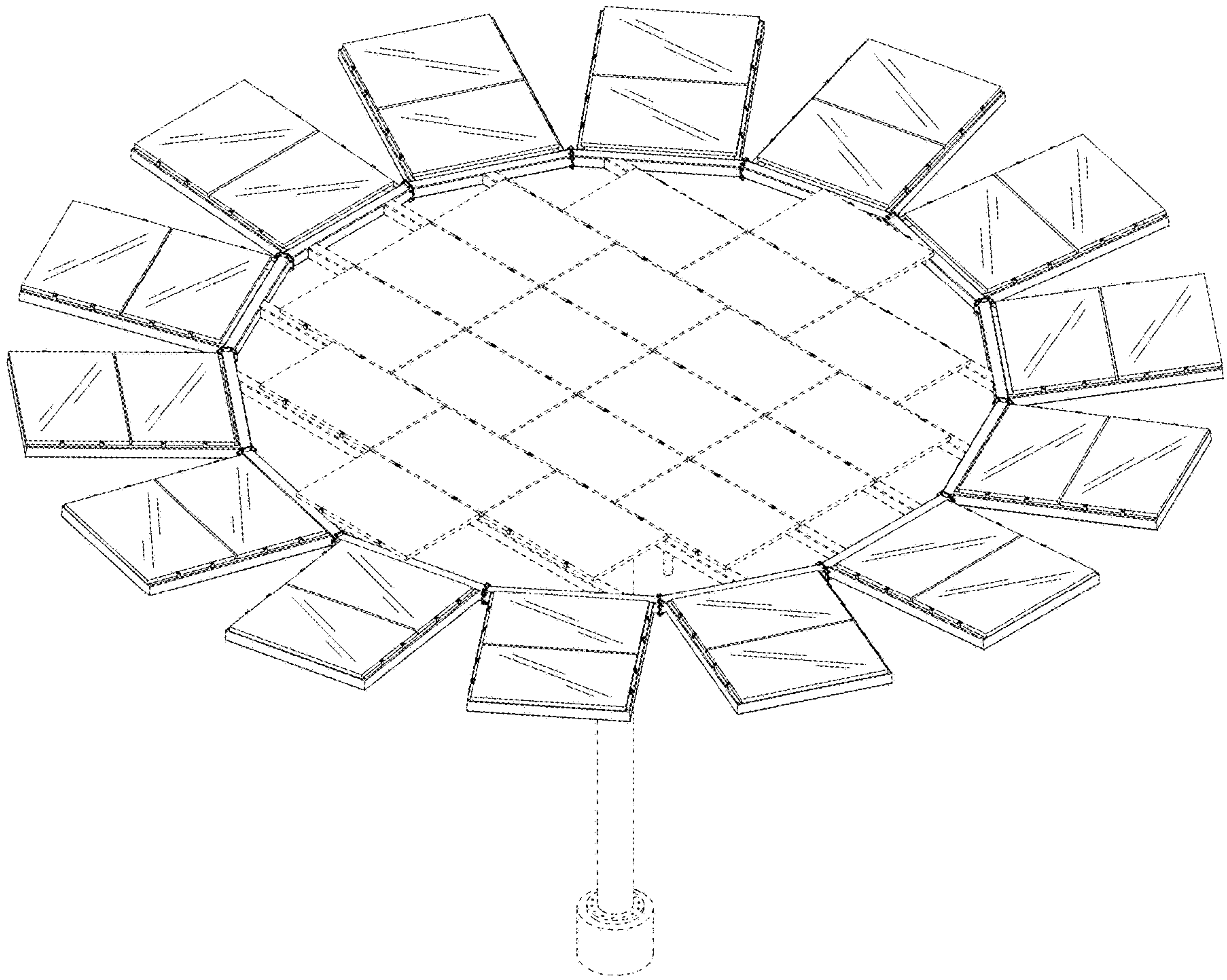

FIG. 29

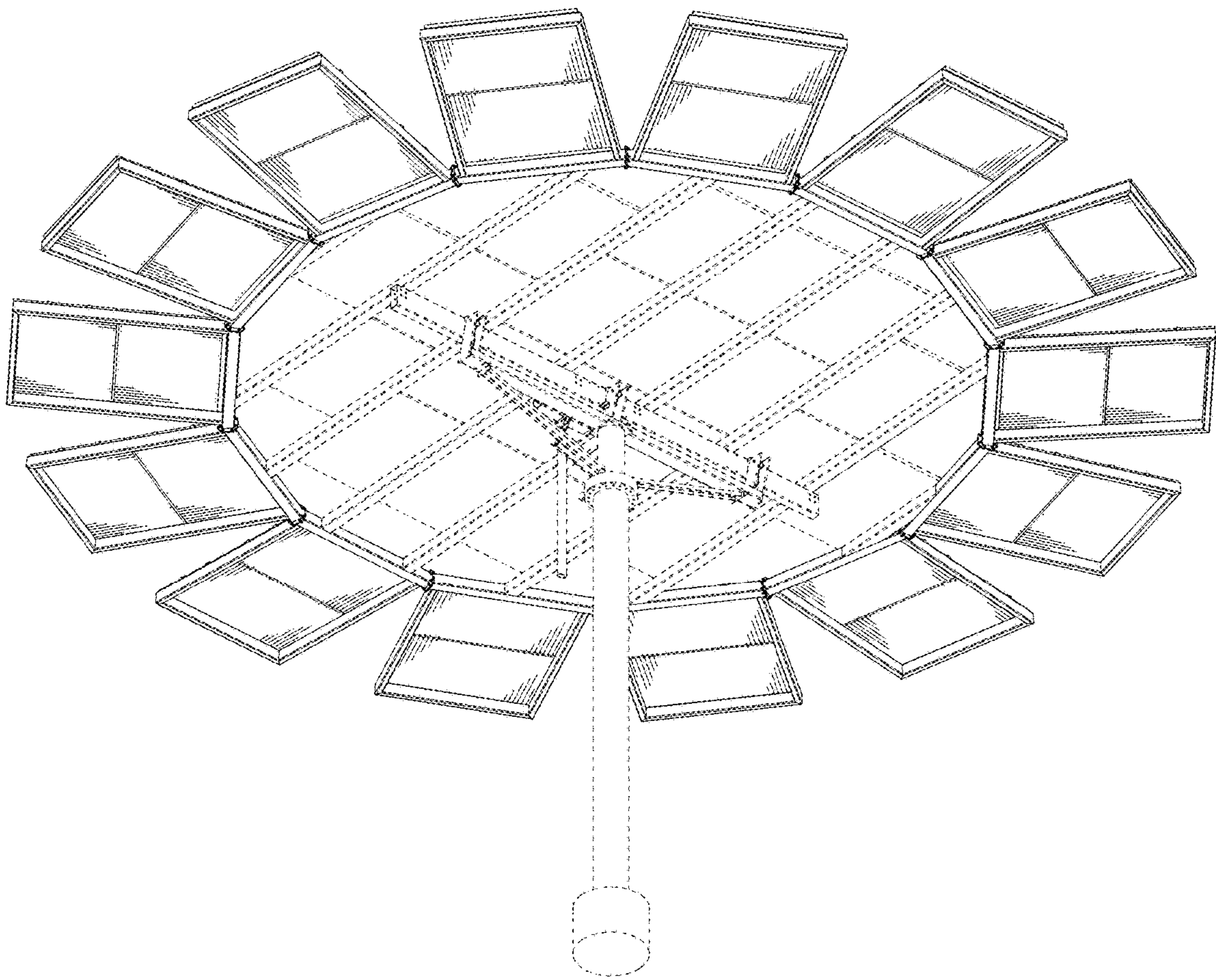

FIG. 30

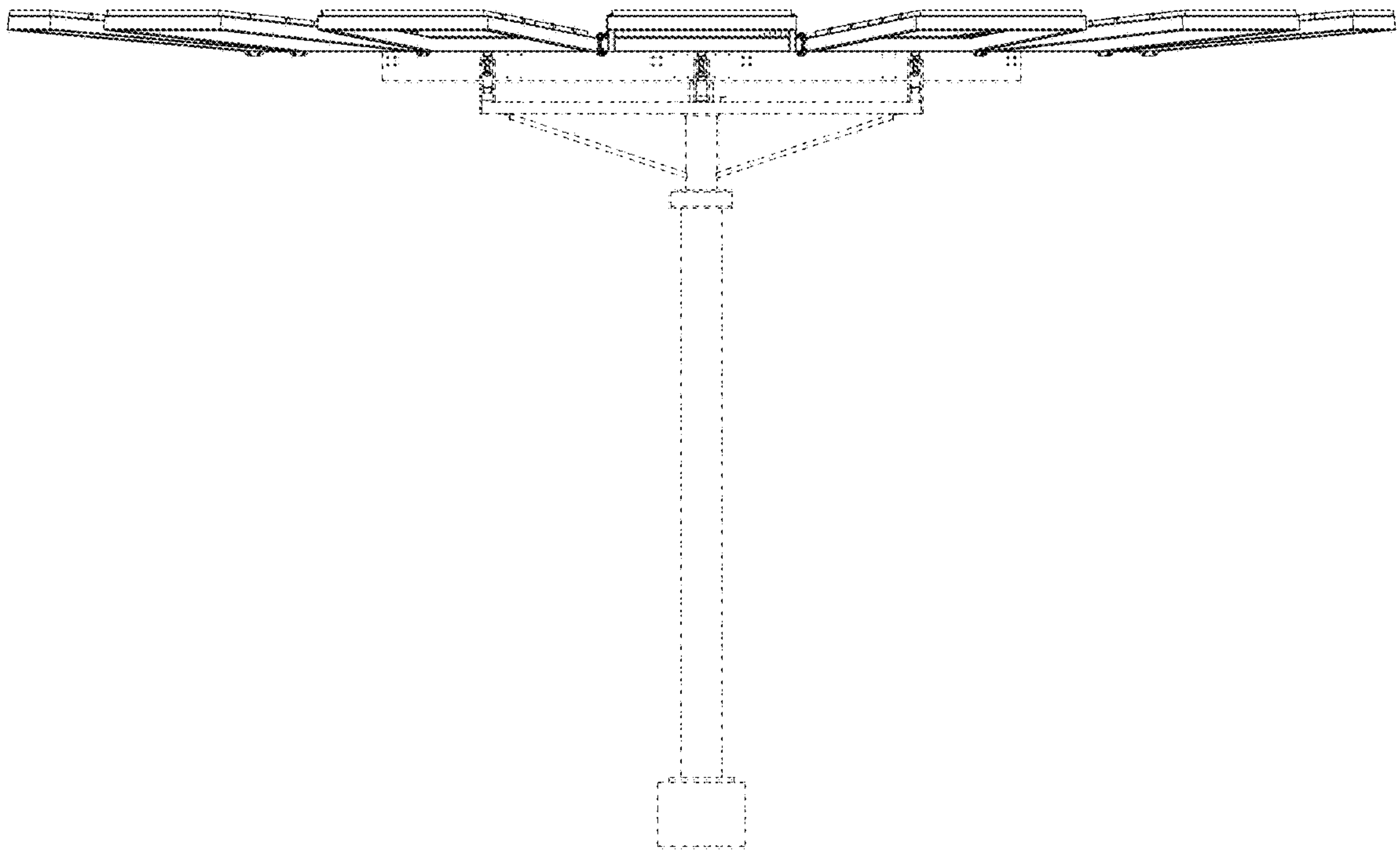

FIG. 31

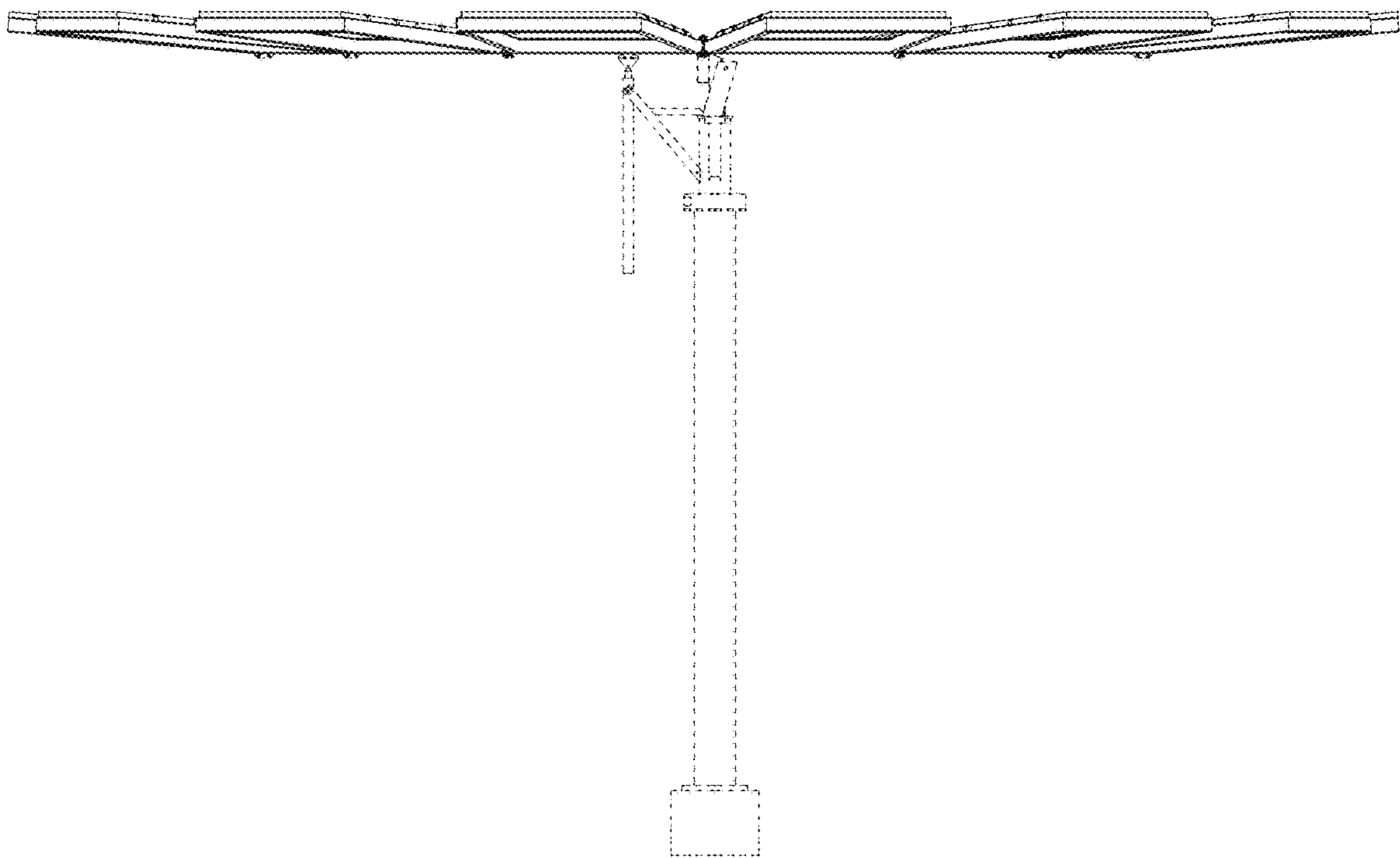

FIG. 32

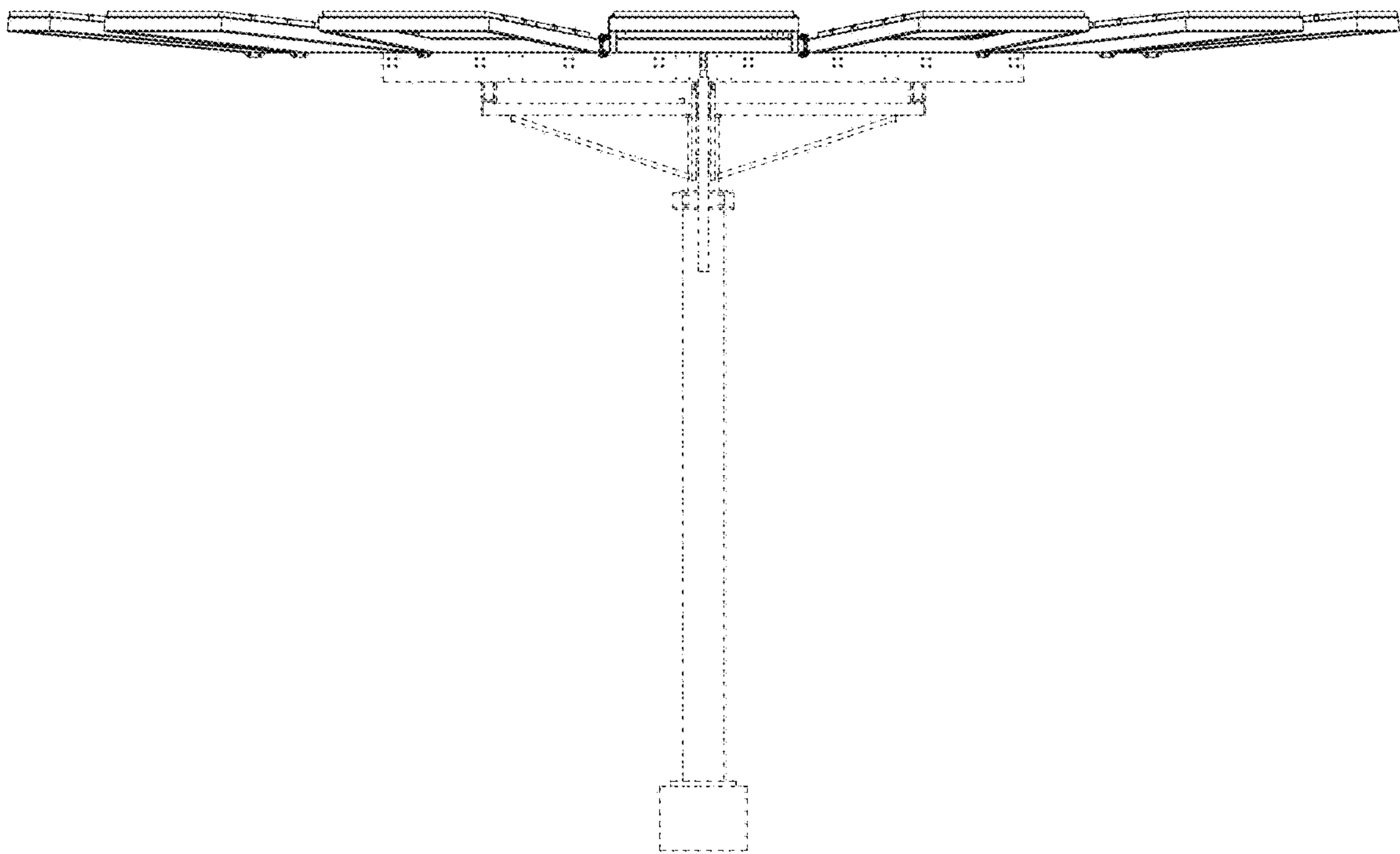

FIG. 33

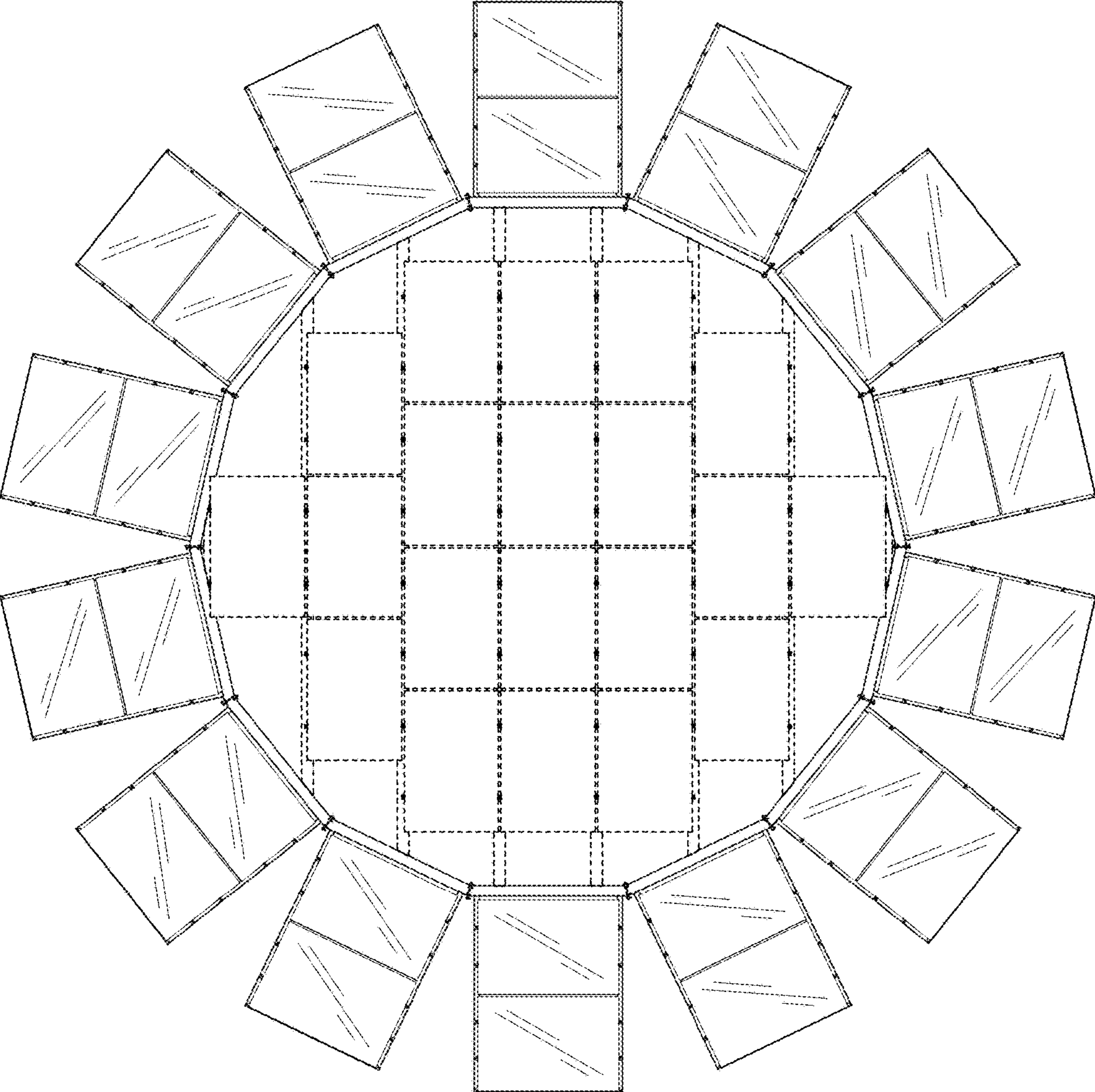

FIG. 34

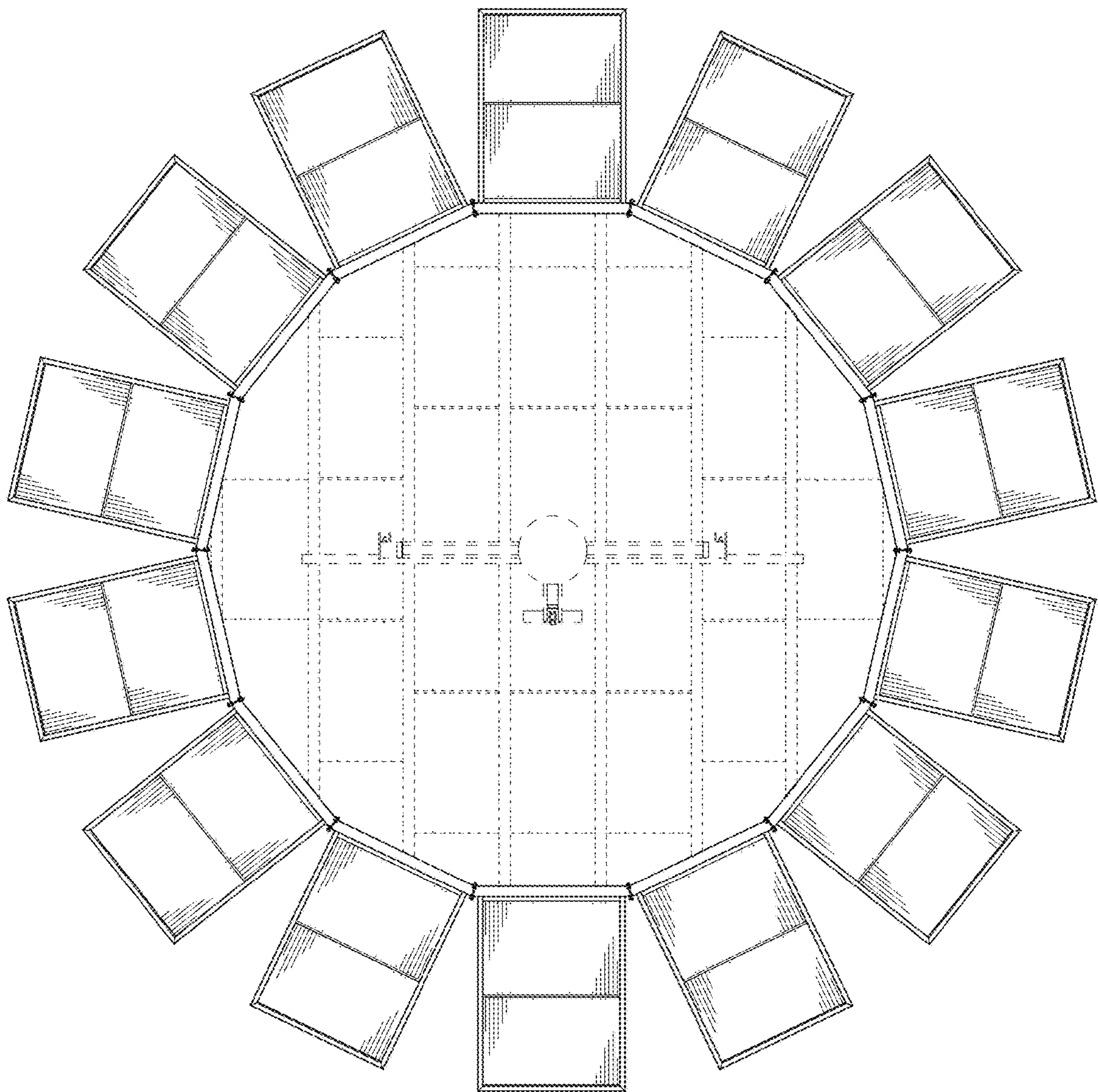

FIG. 35

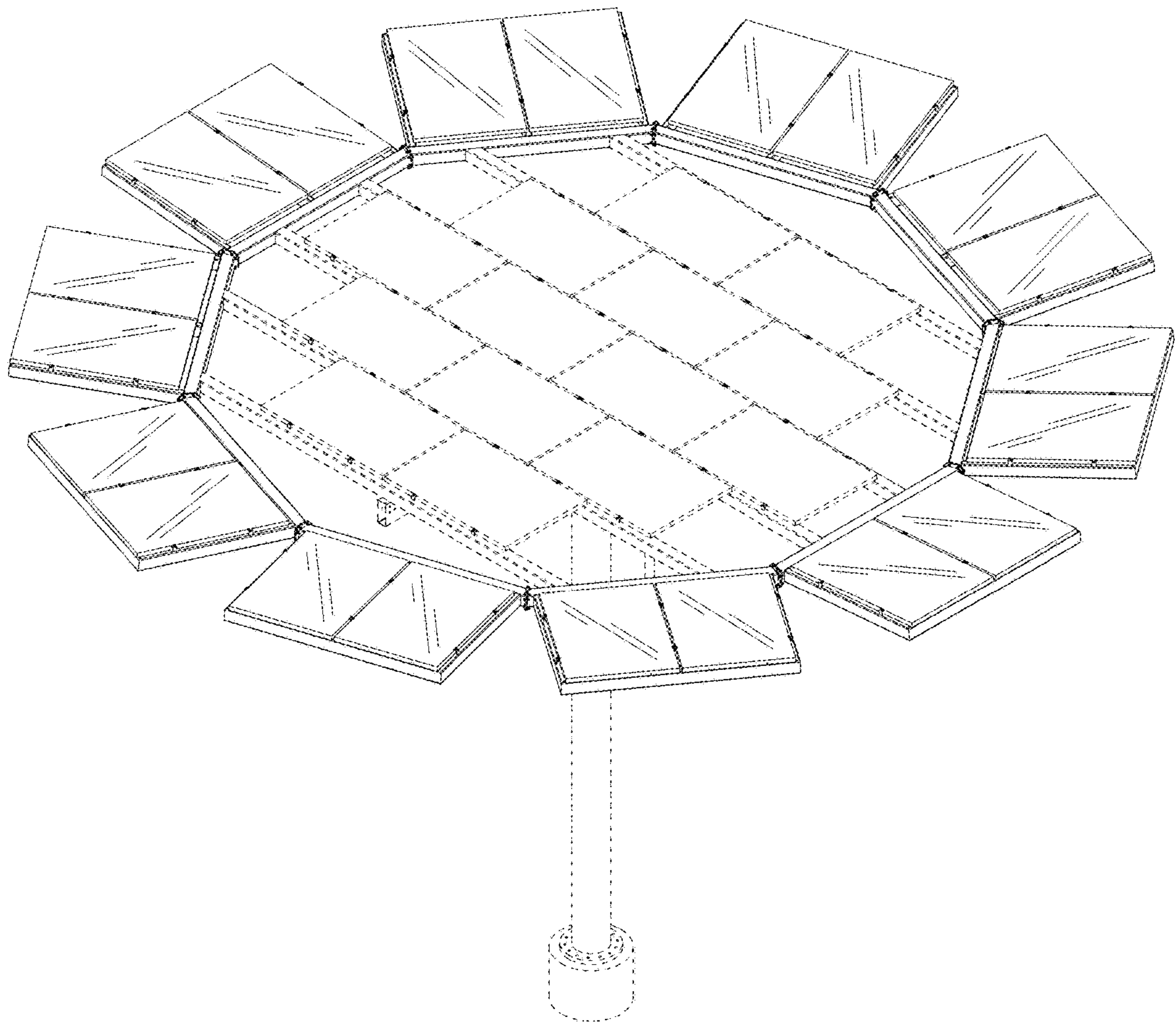

FIG. 36

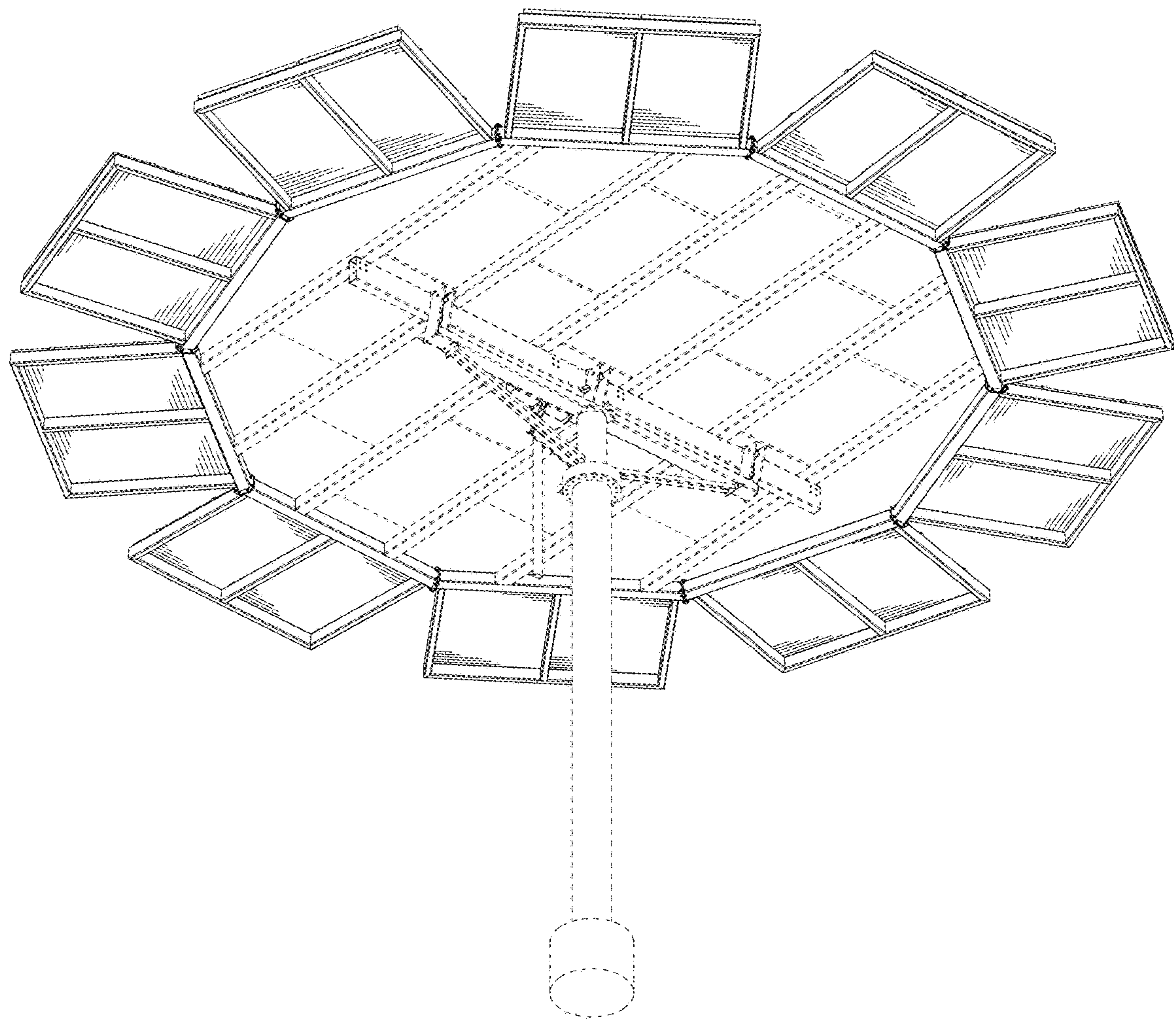

FIG. 37

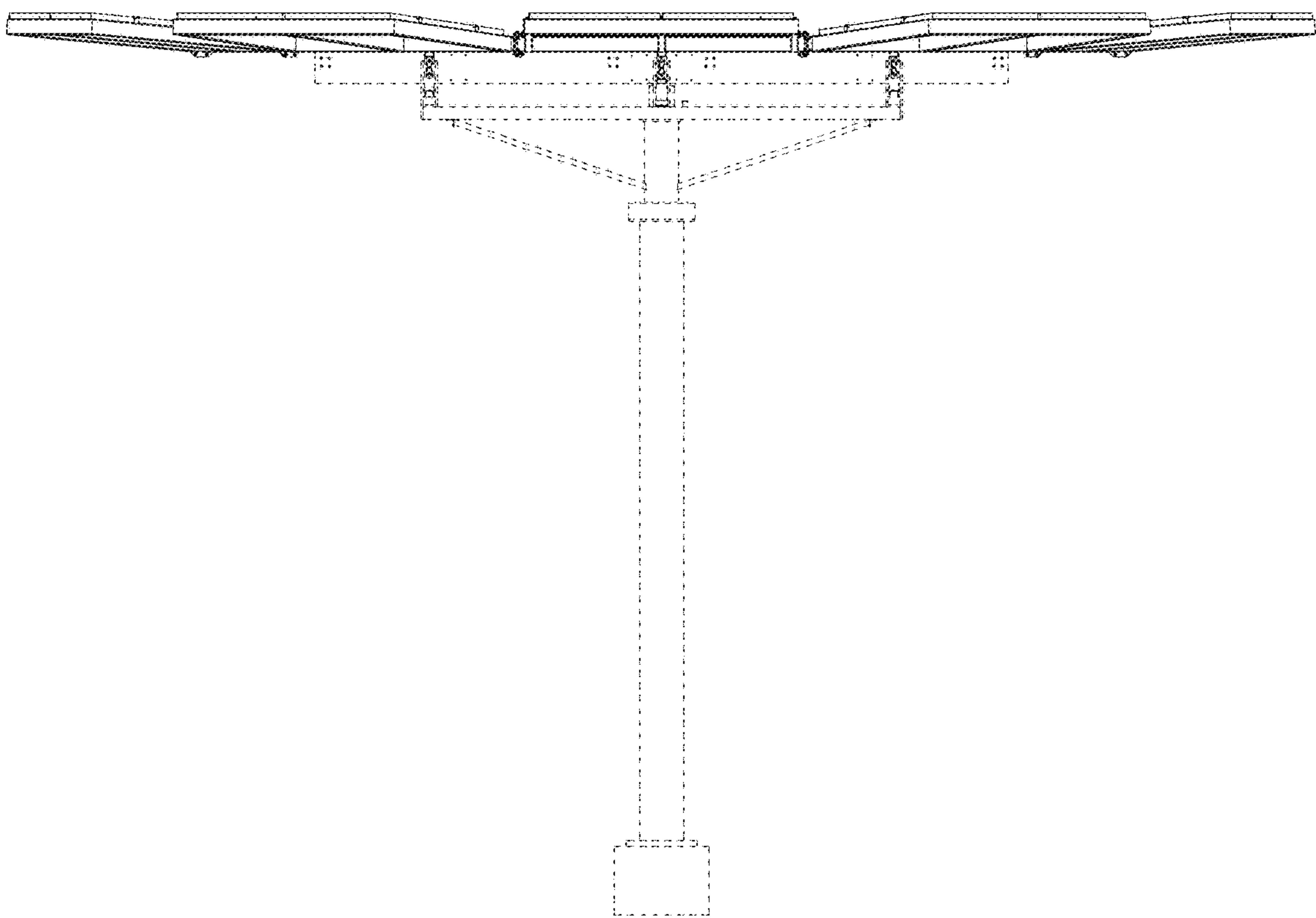

FIG. 38

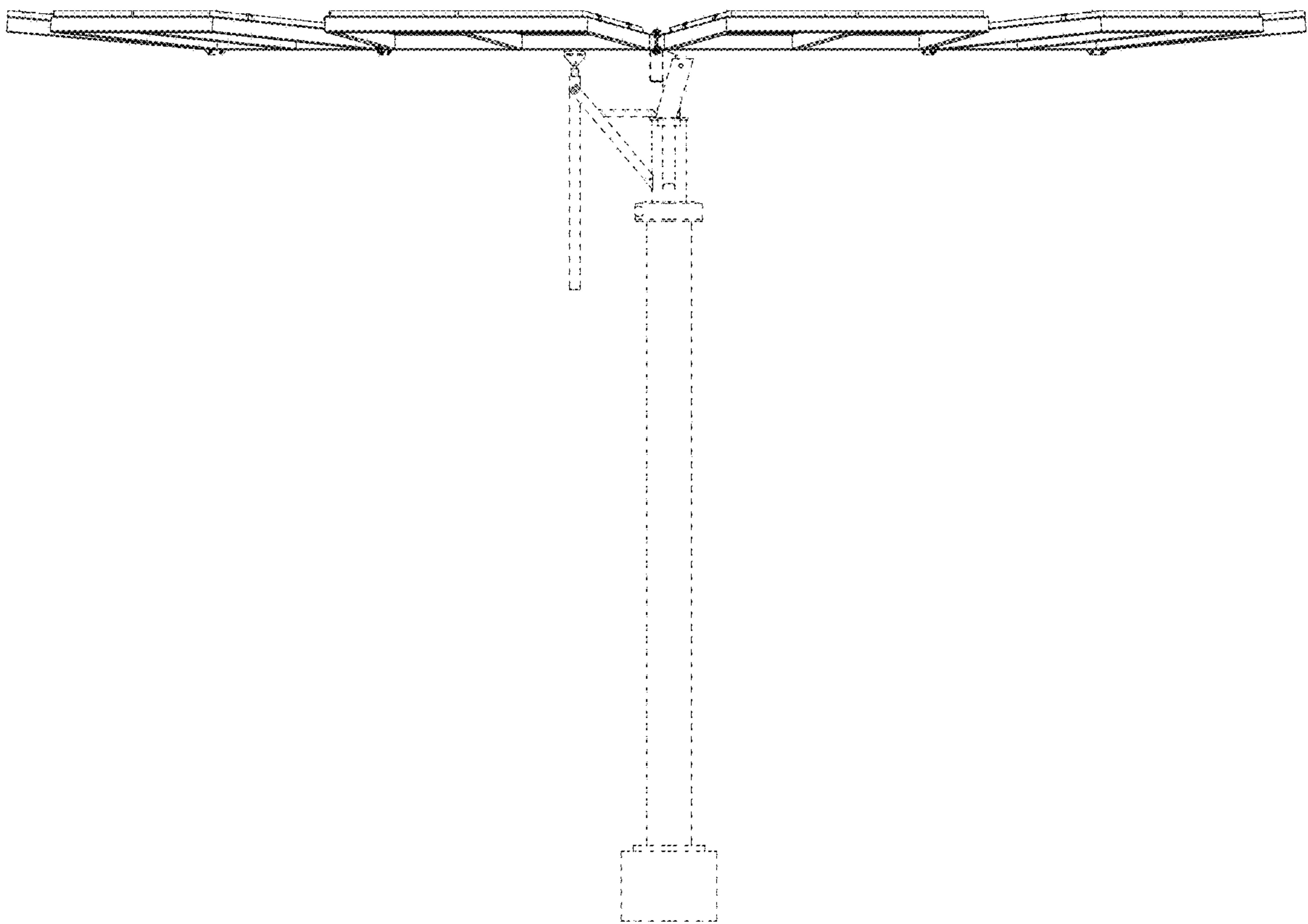

FIG. 39

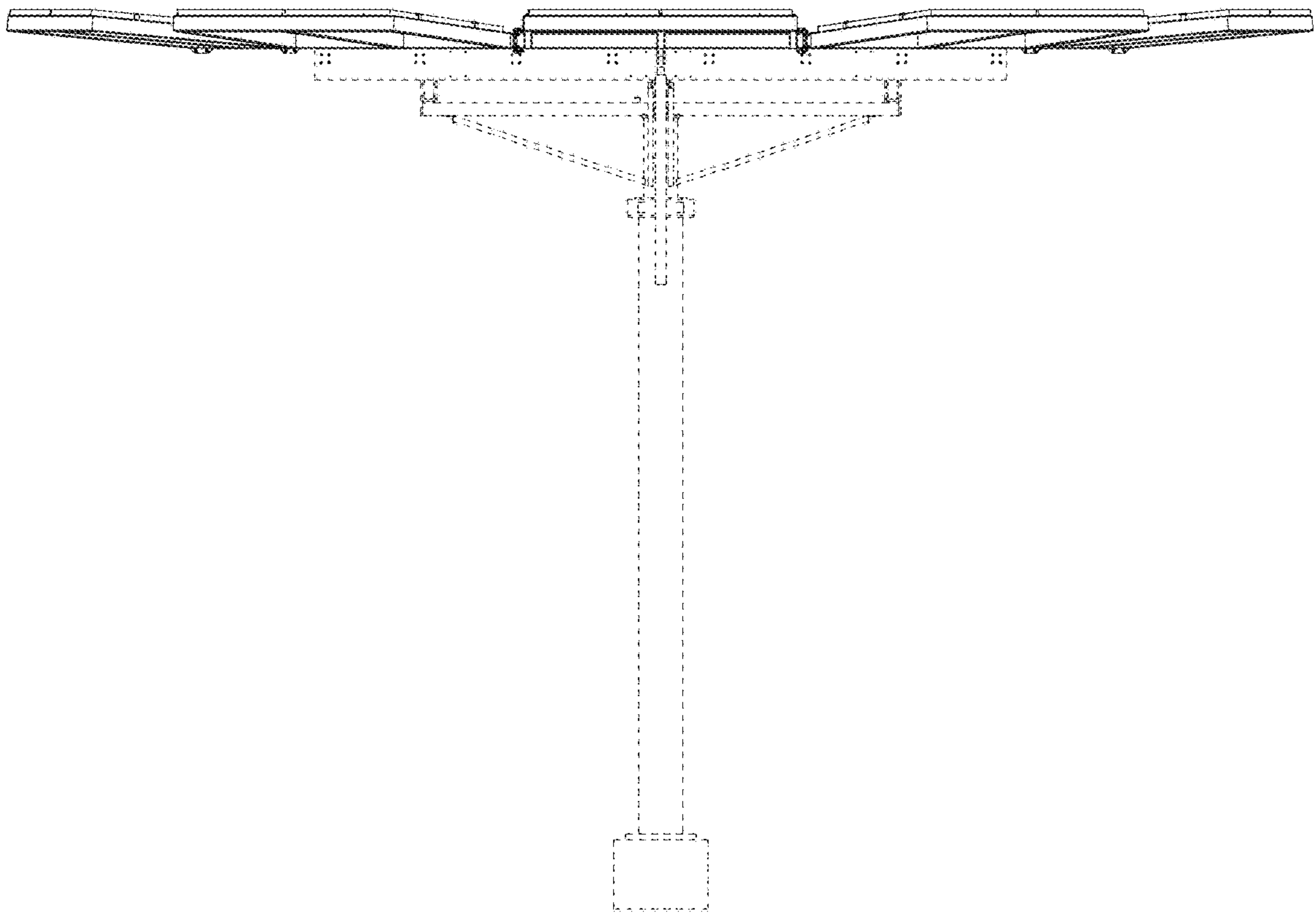

FIG. 40

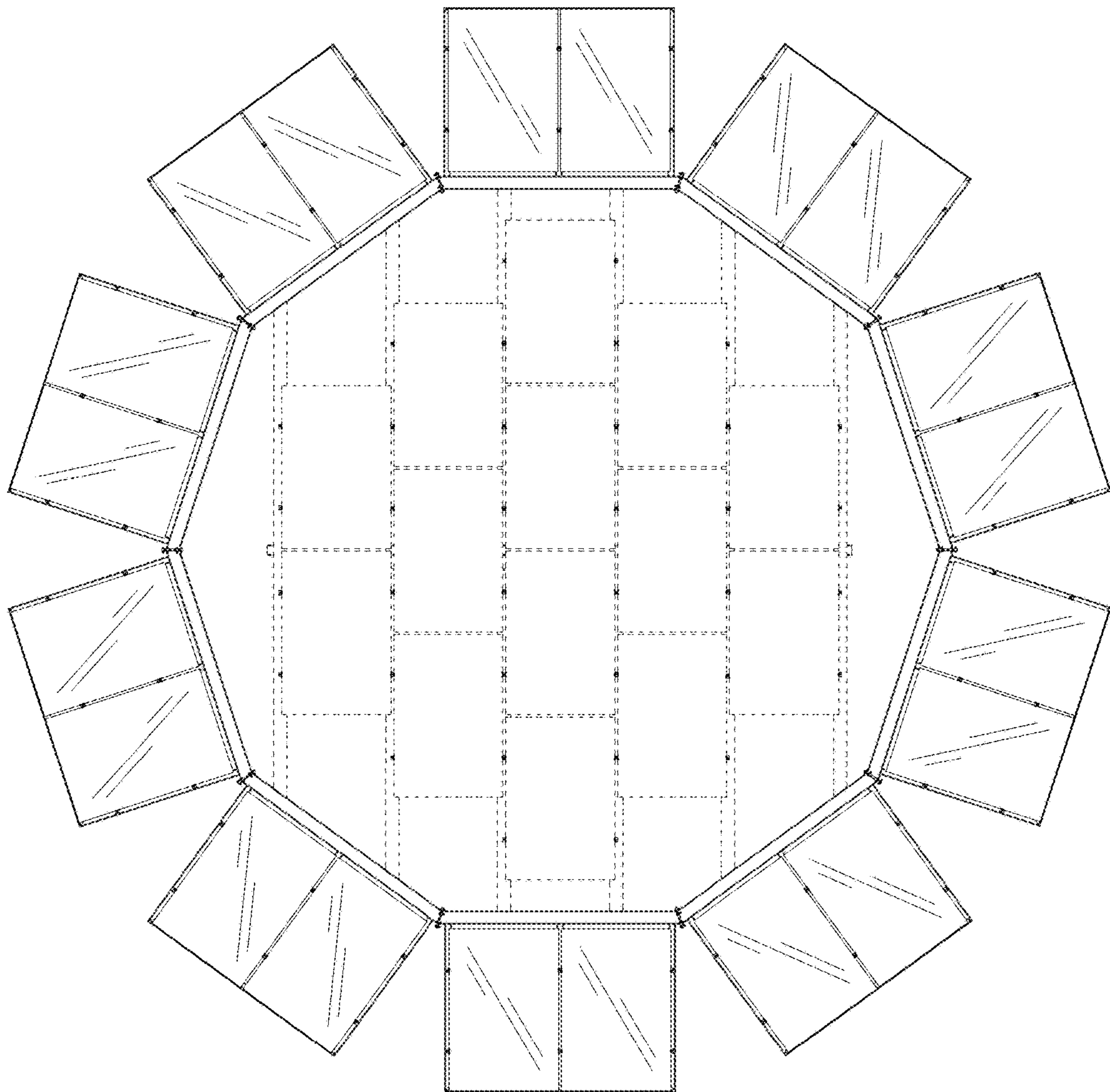

FIG. 41

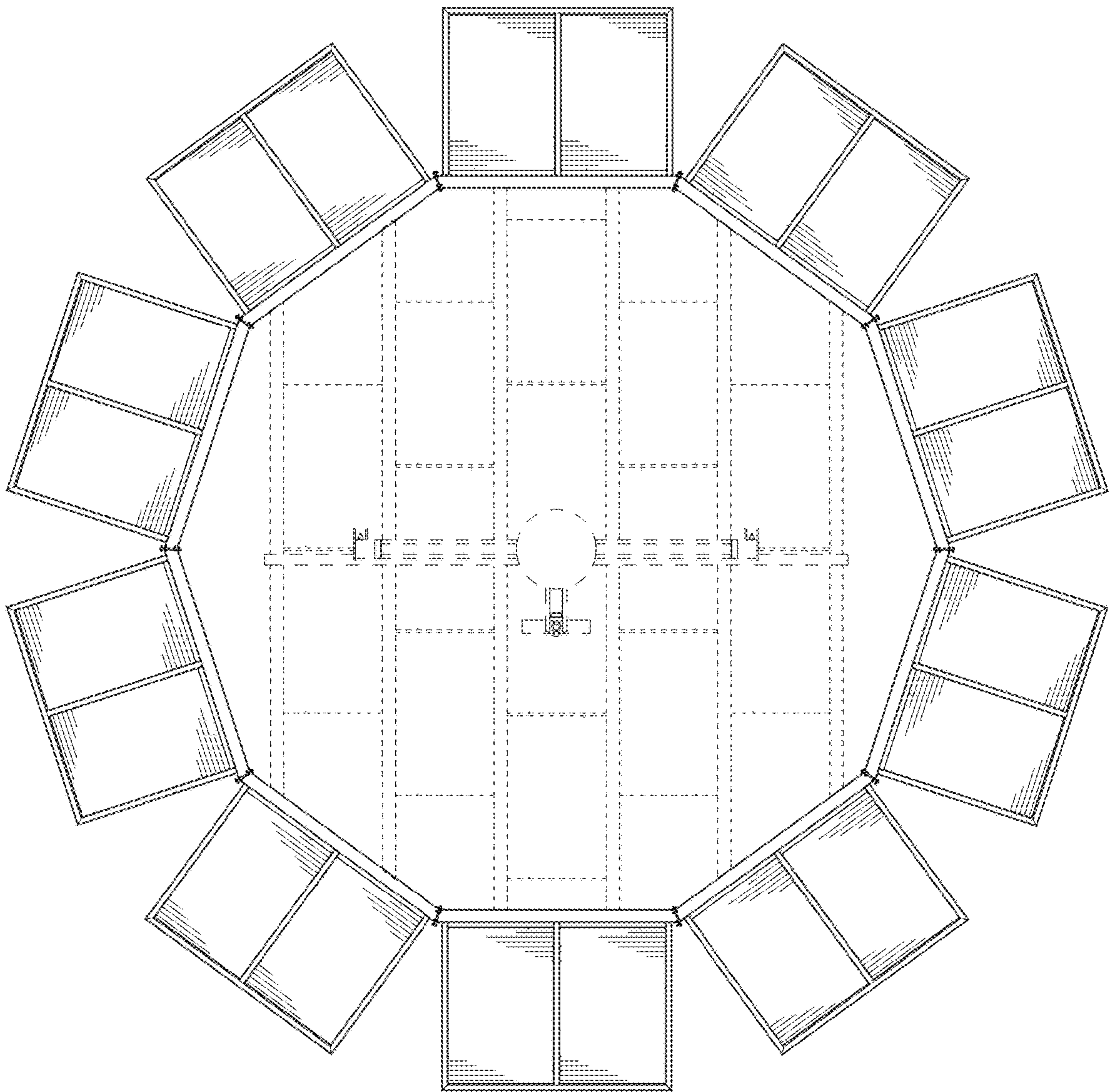

FIG. 42

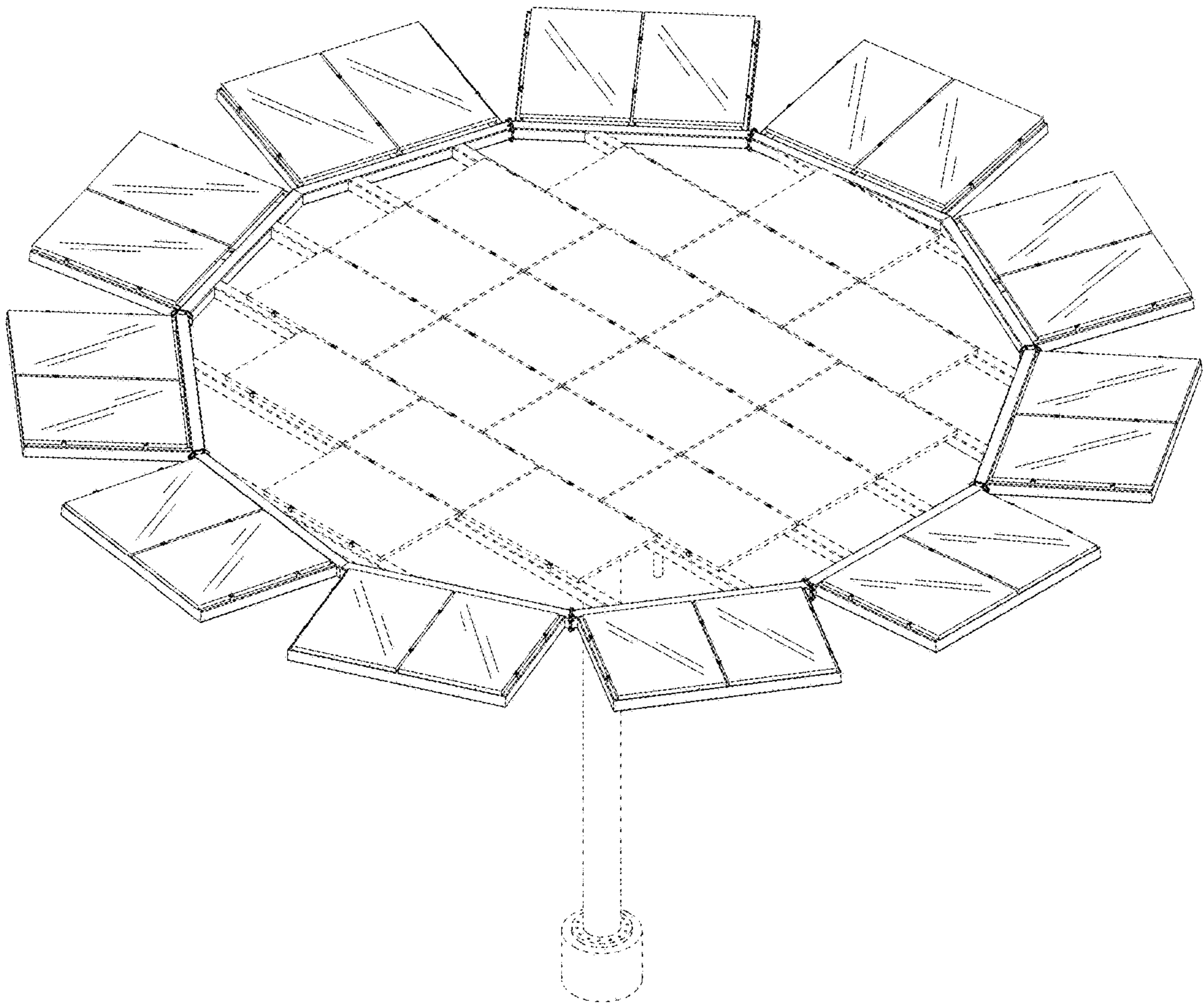

FIG. 43

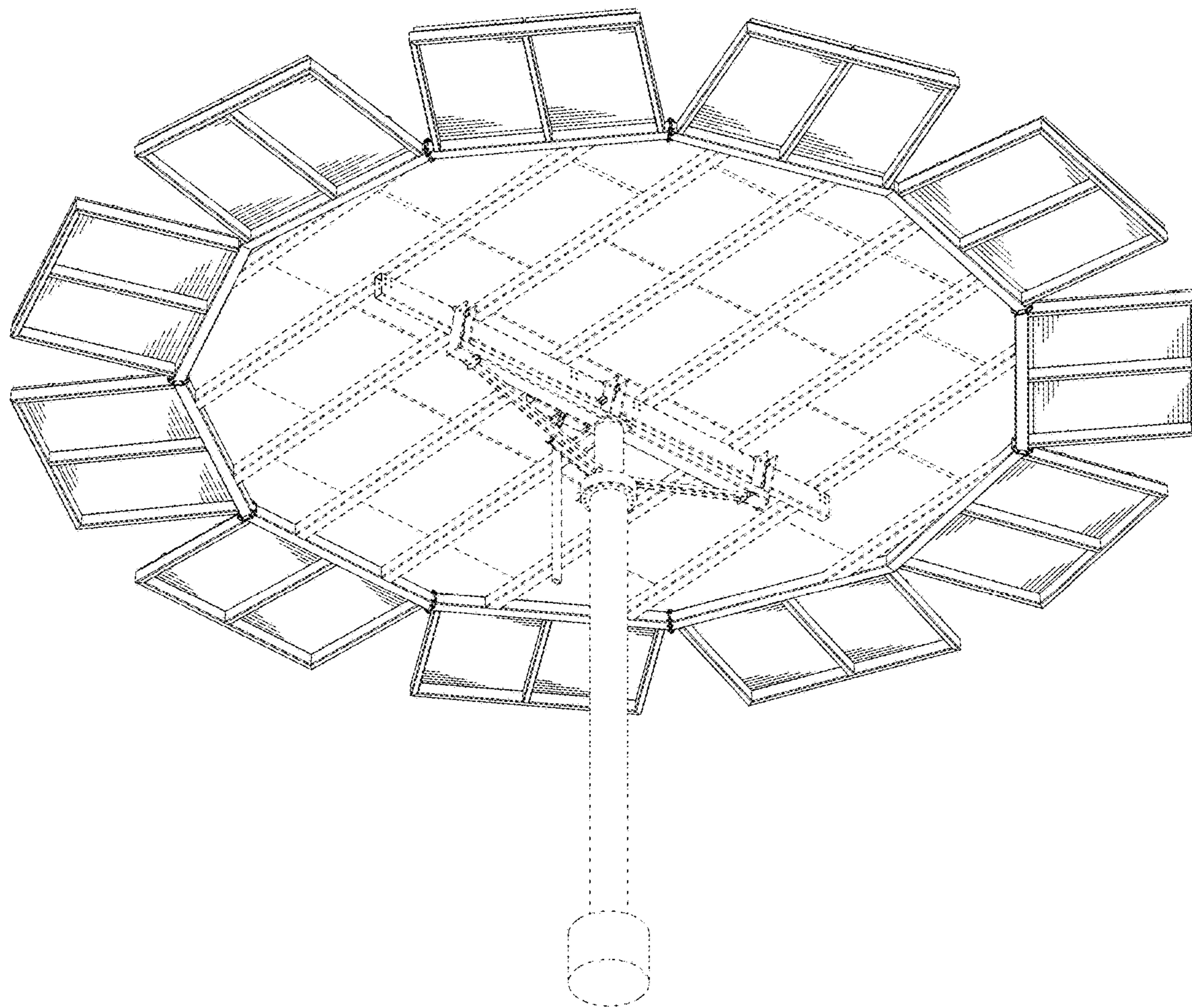

FIG. 44

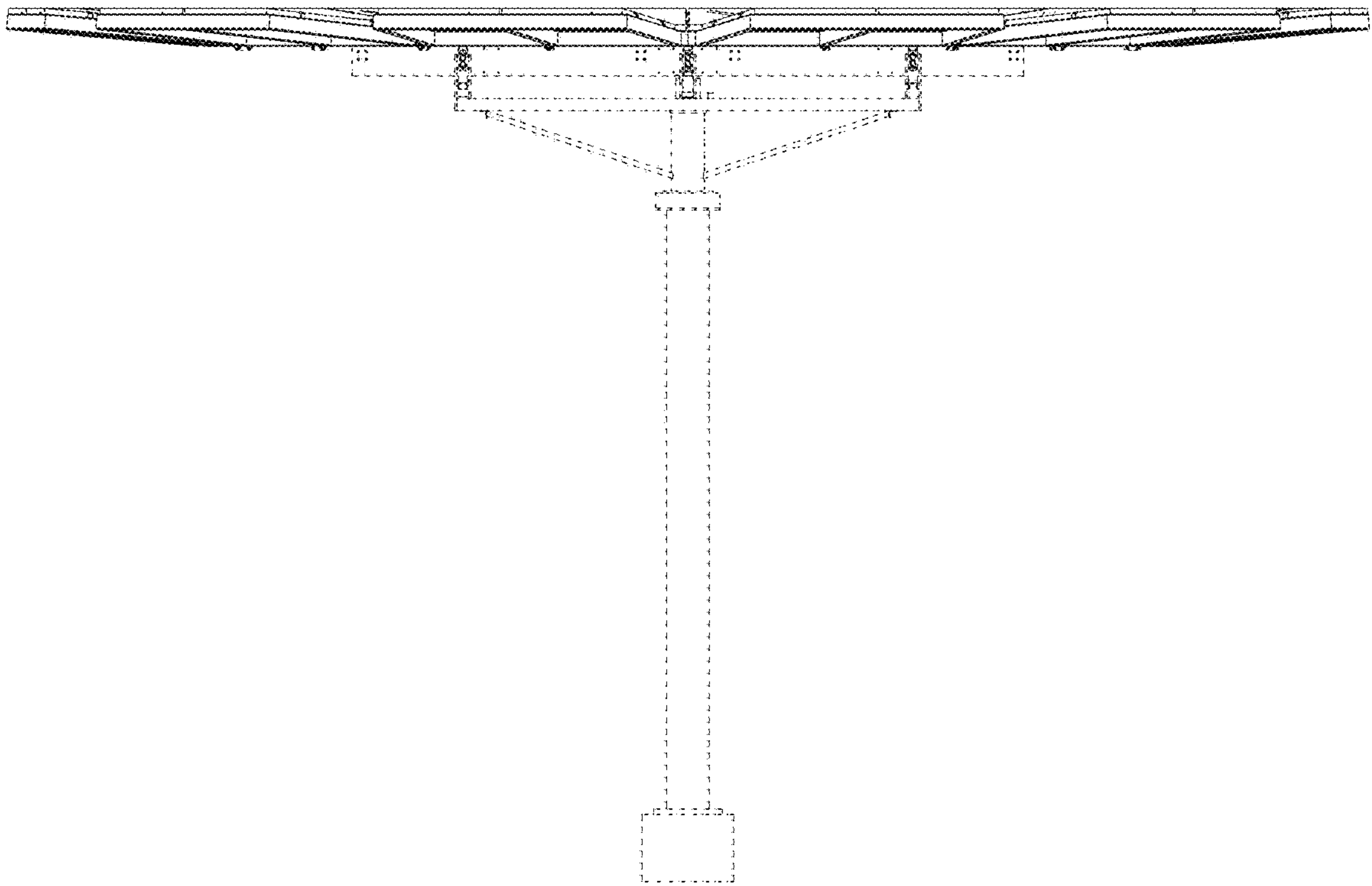

FIG. 45

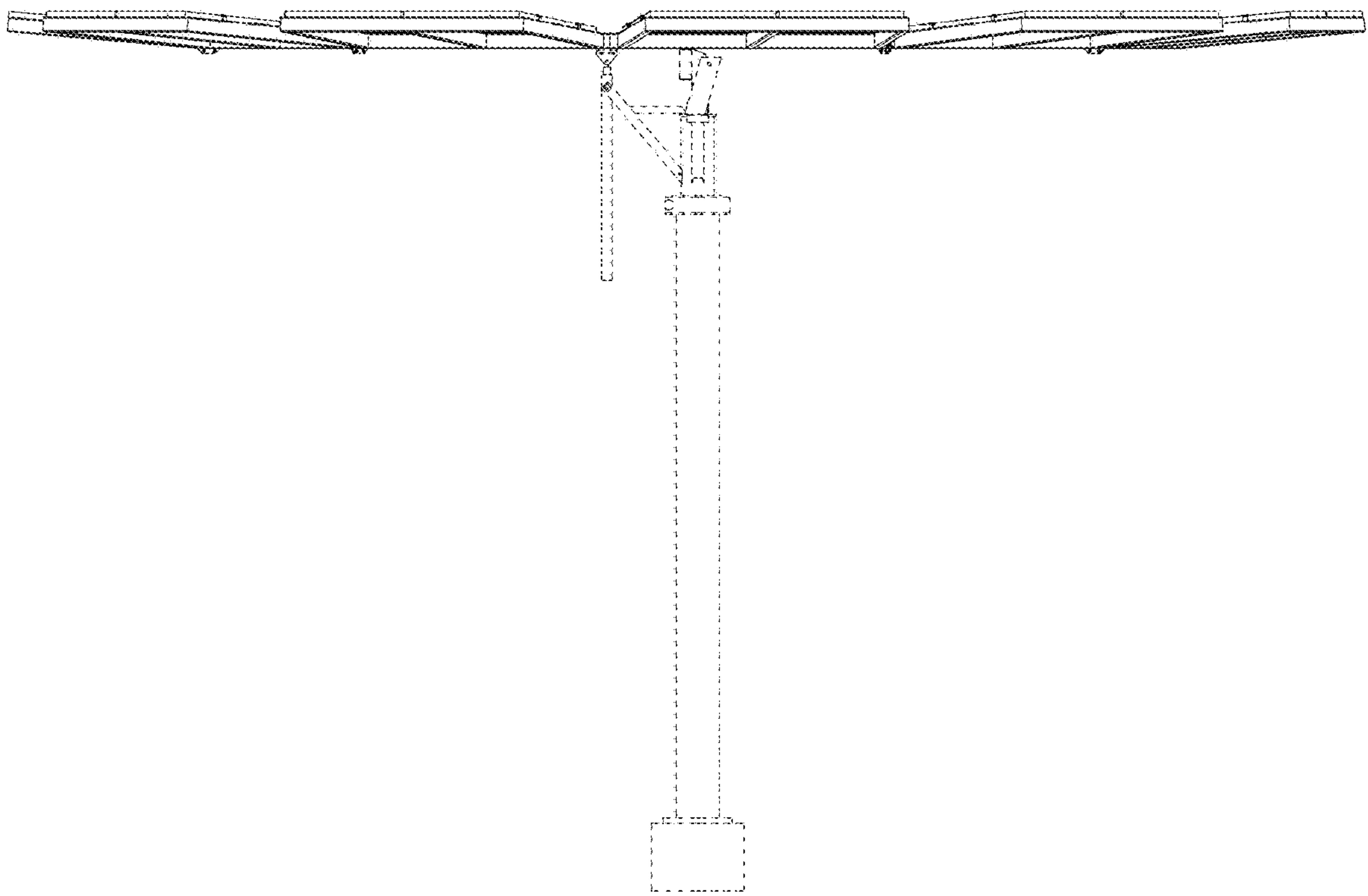

FIG. 46

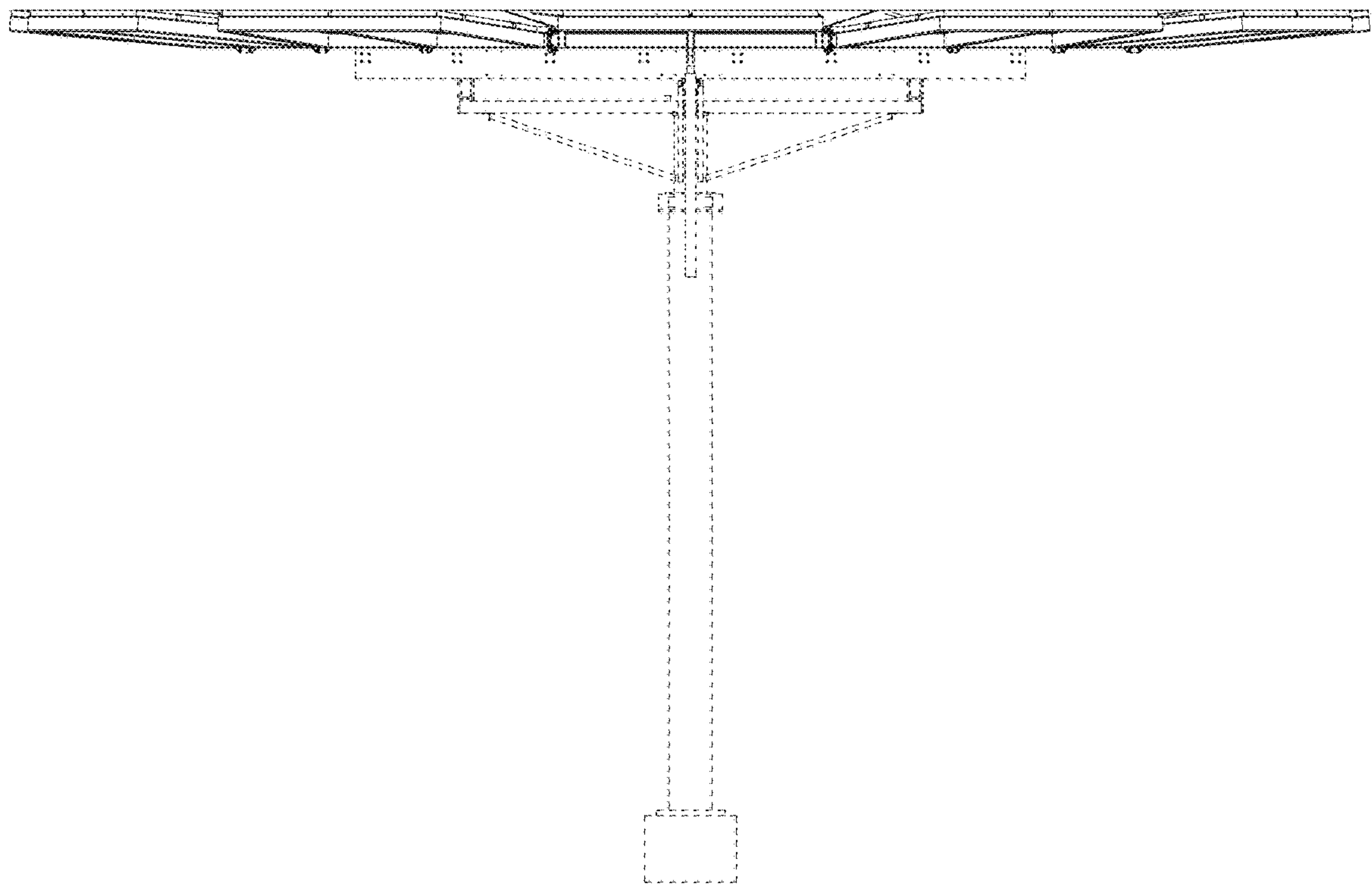

FIG. 47

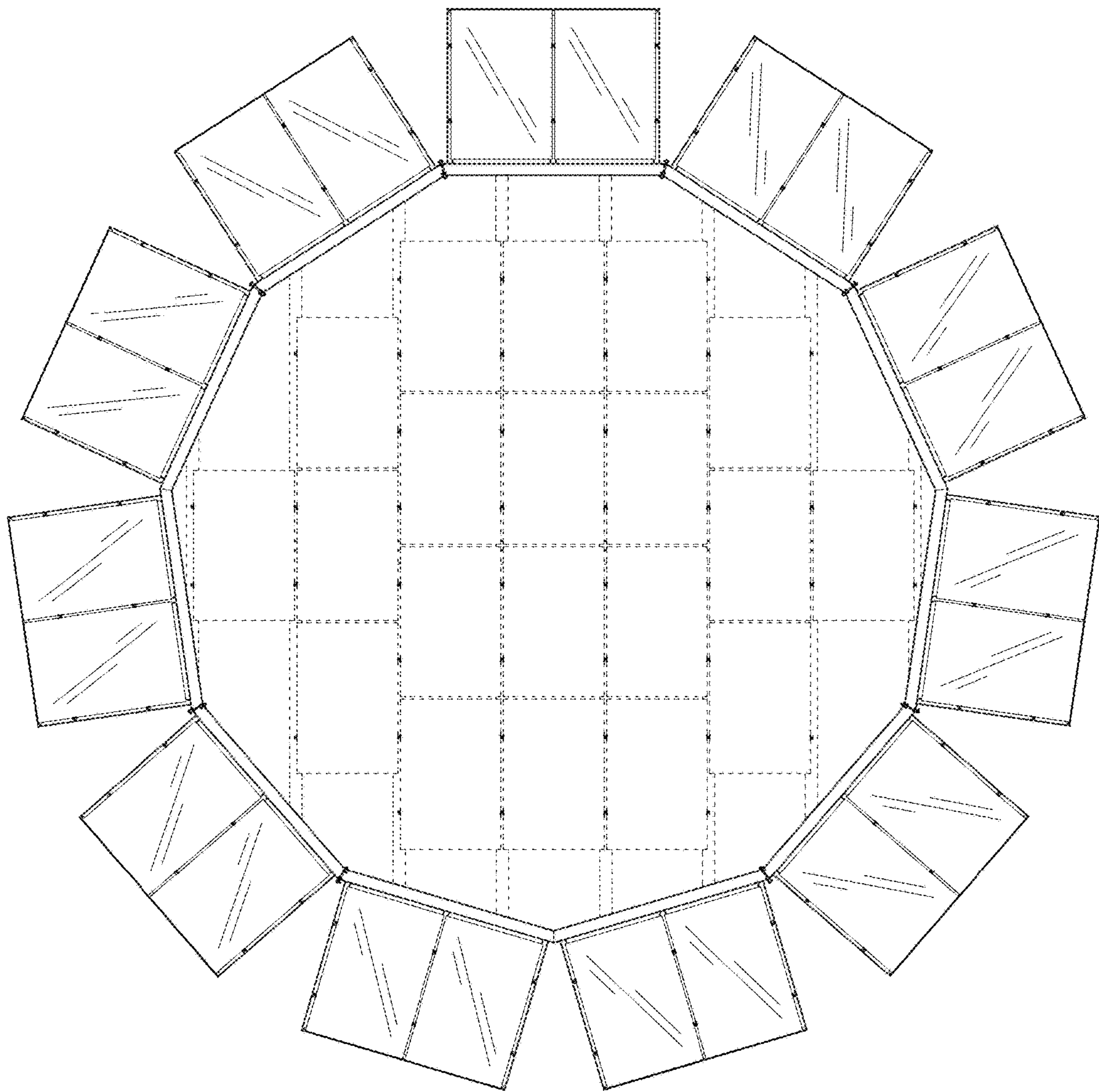

FIG. 48

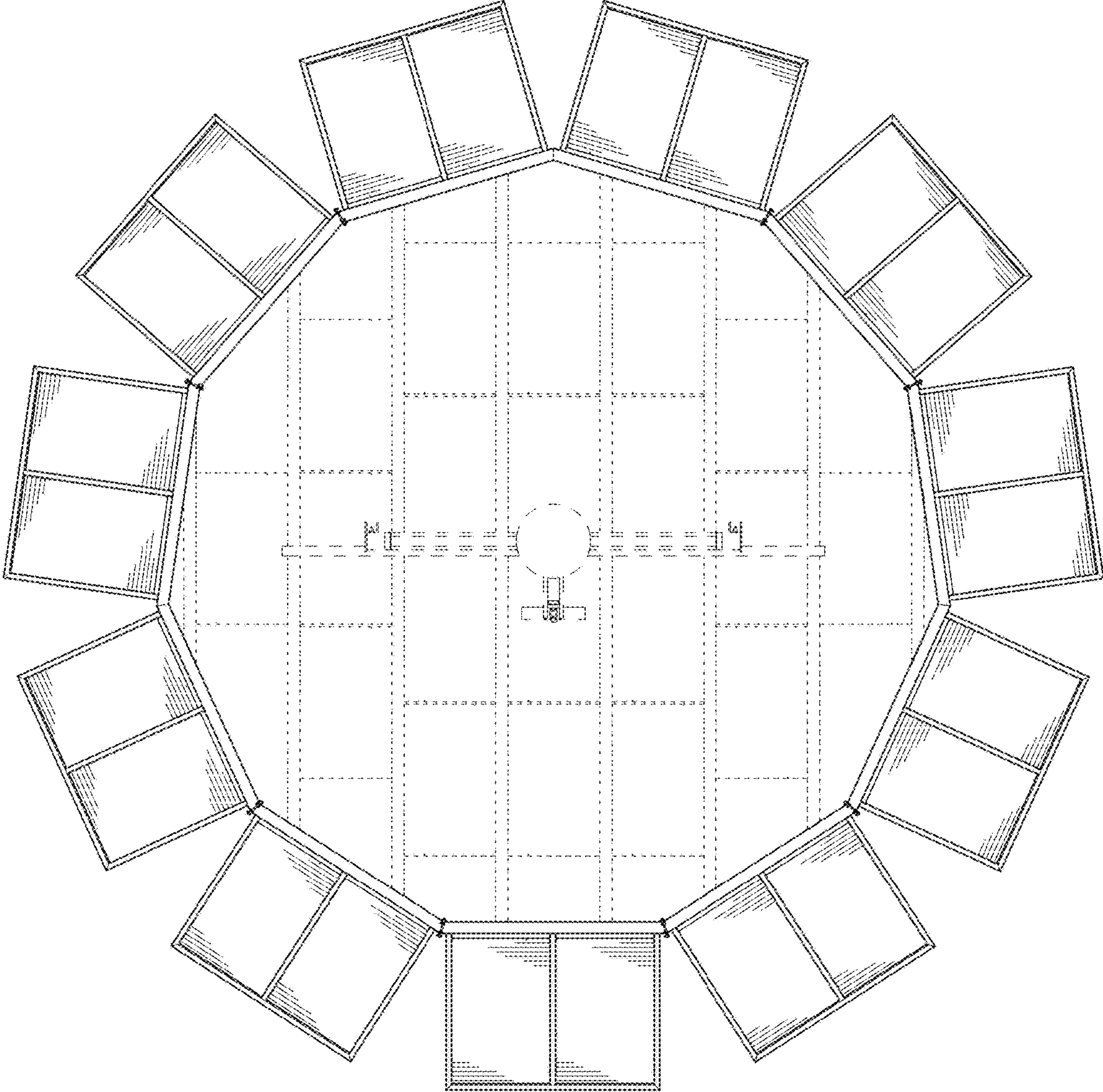

FIG. 49

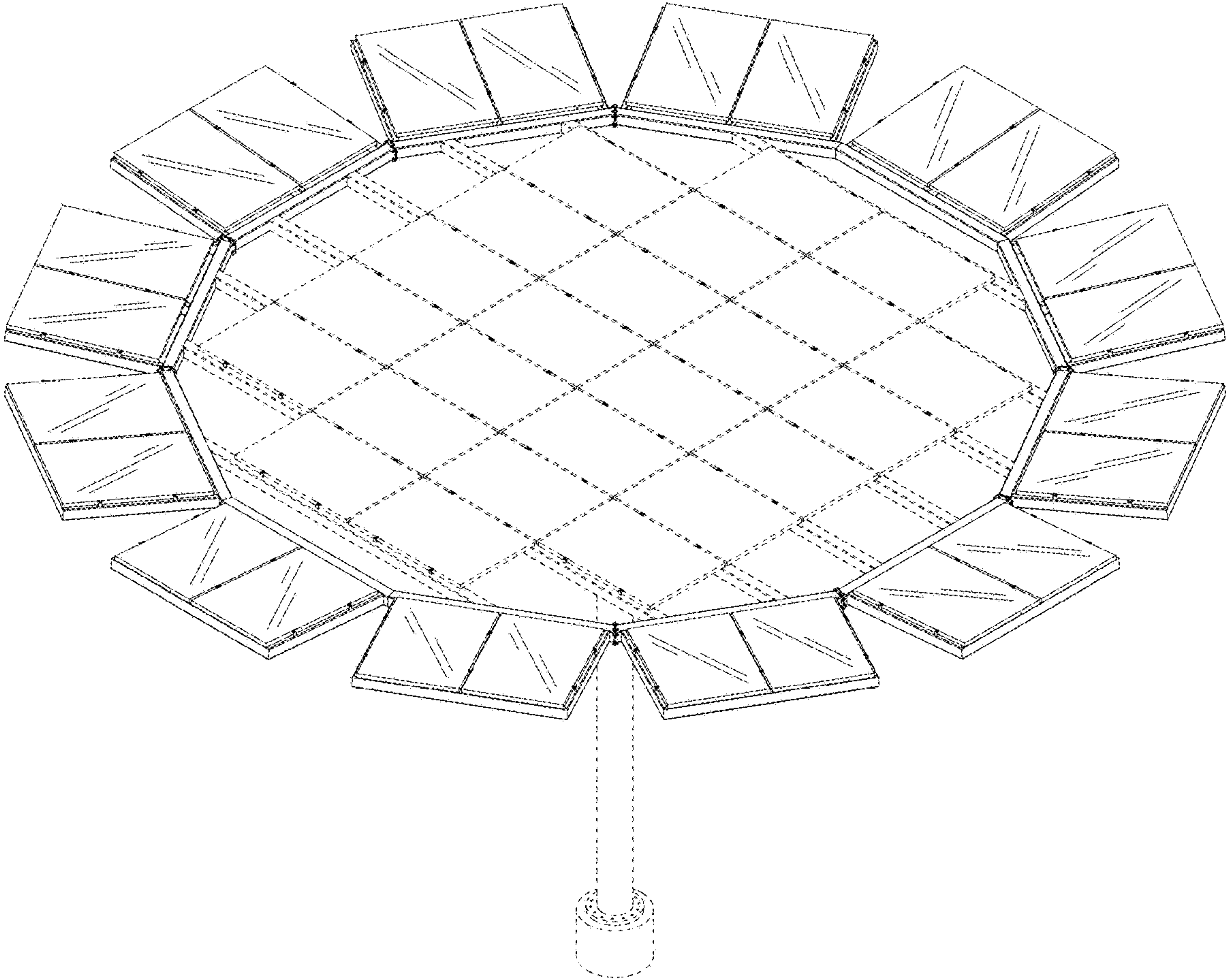

FIG. 50

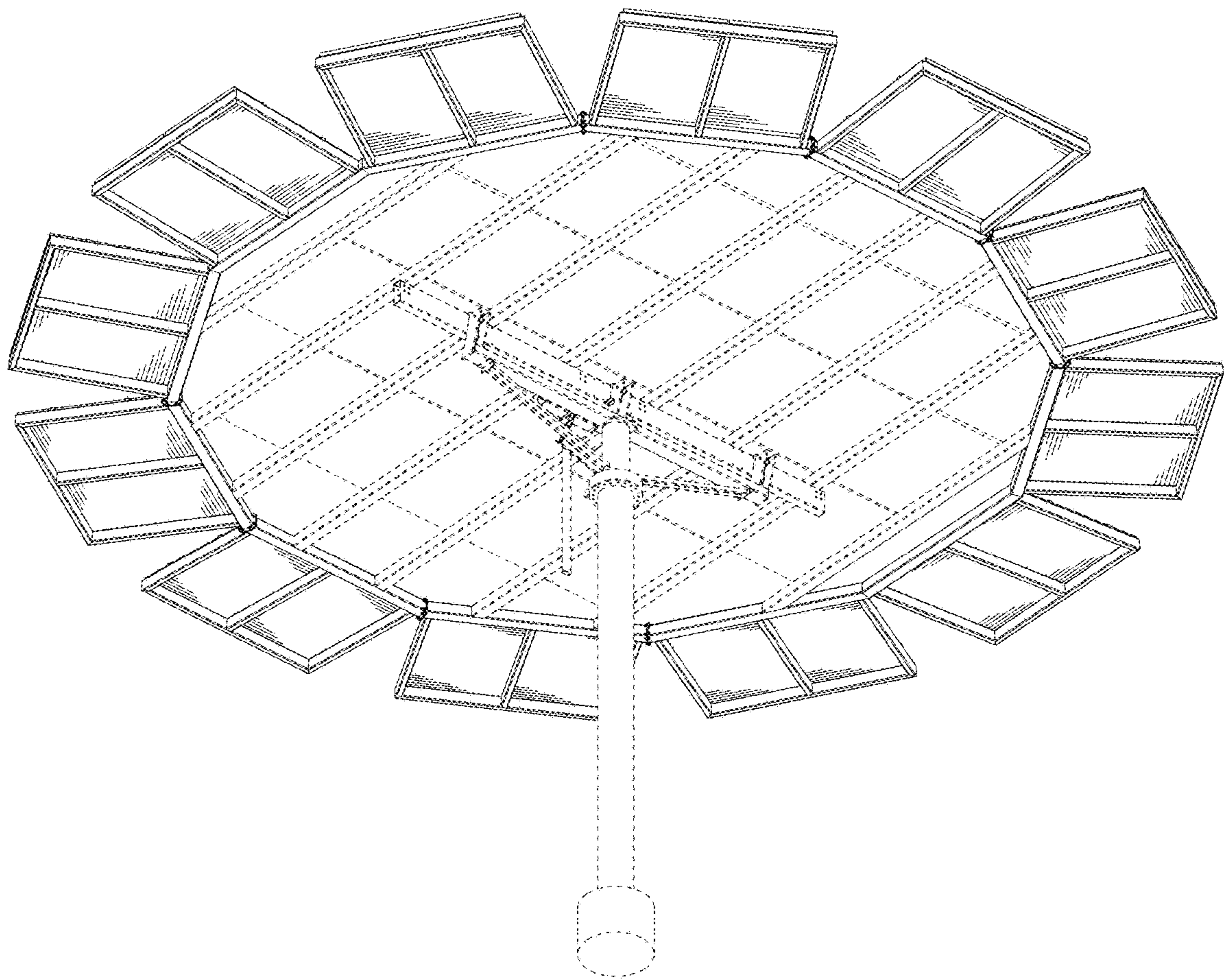

FIG. 51

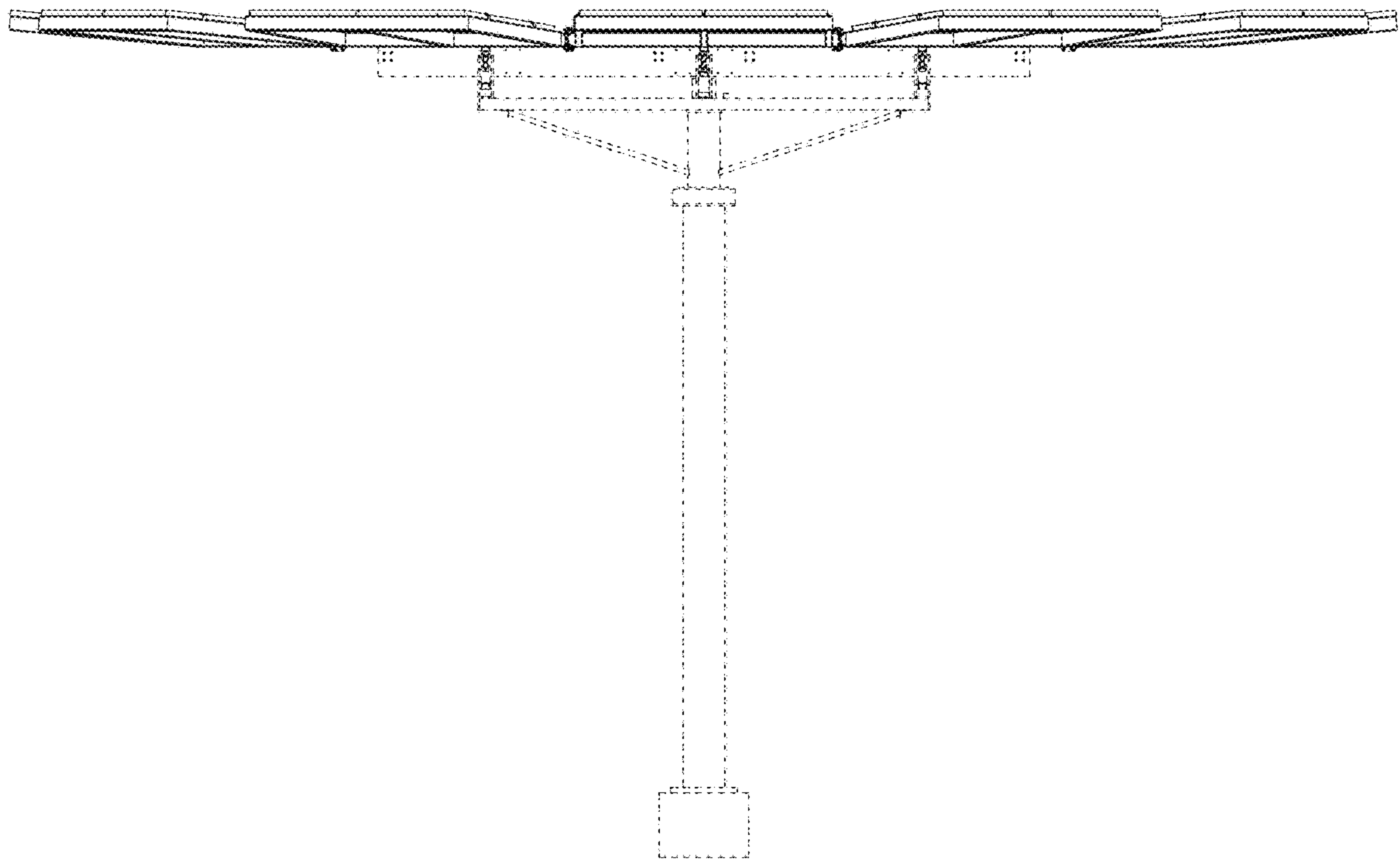

FIG. 52

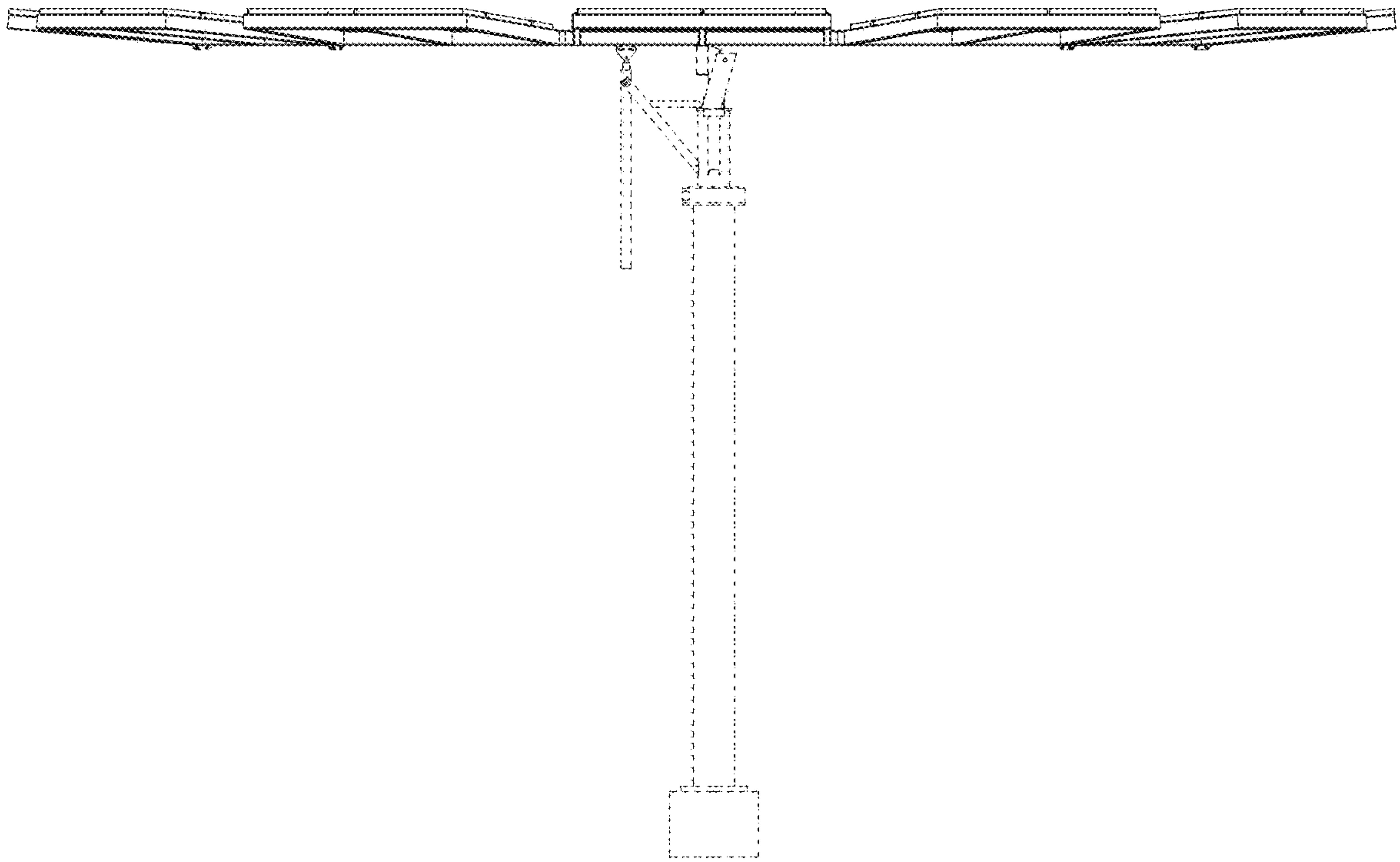

FIG. 53

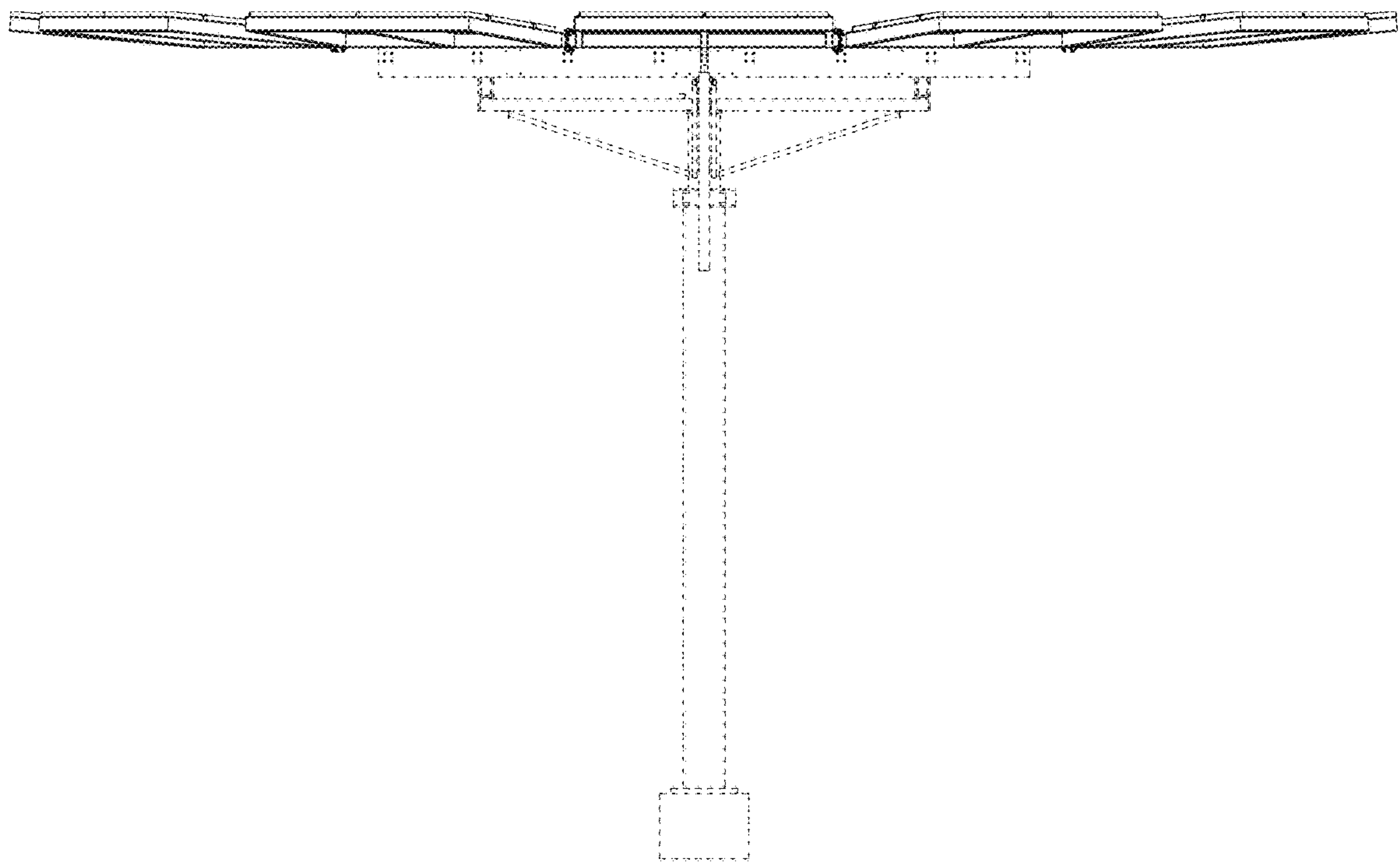

FIG. 54

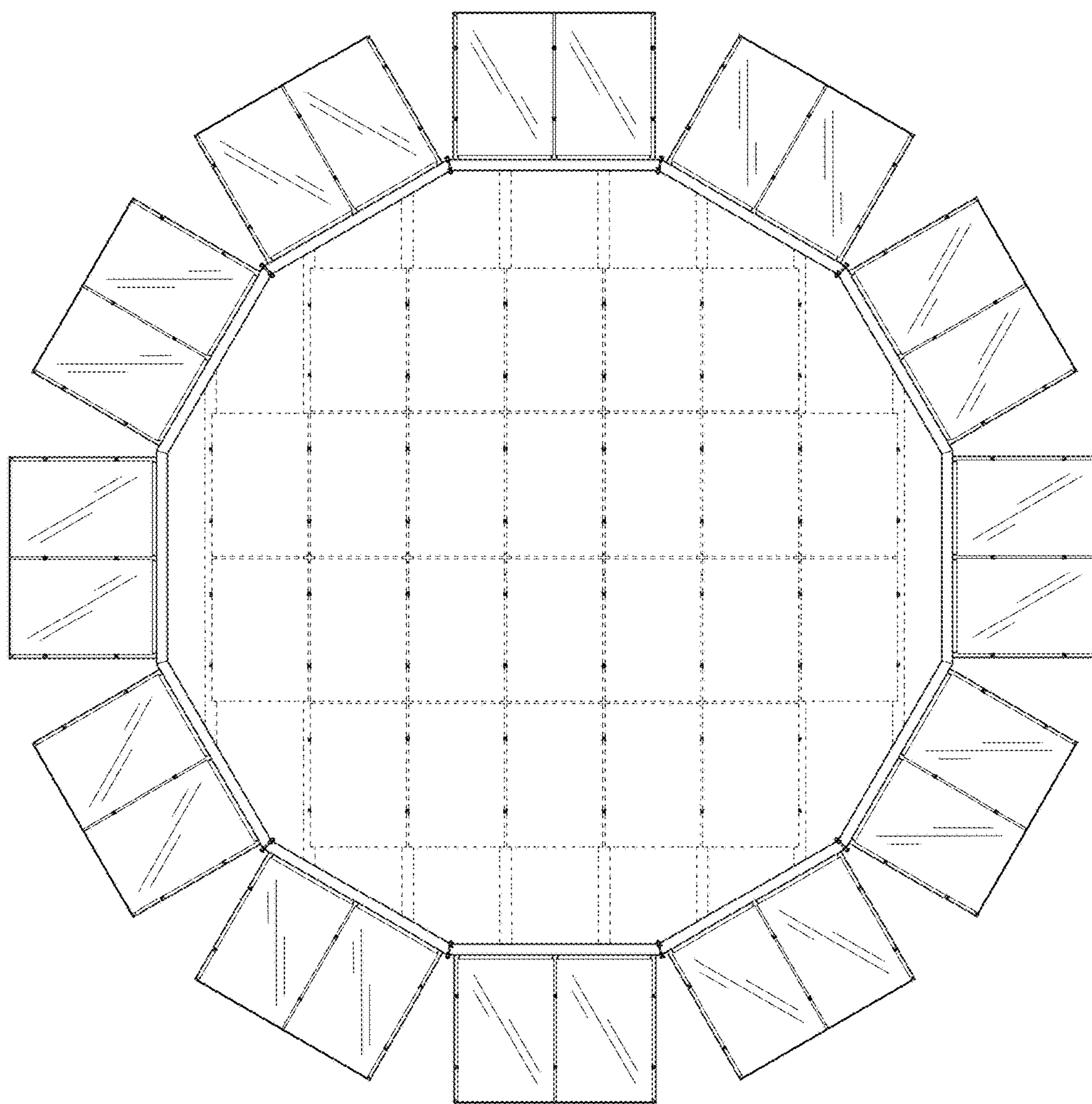

FIG. 55

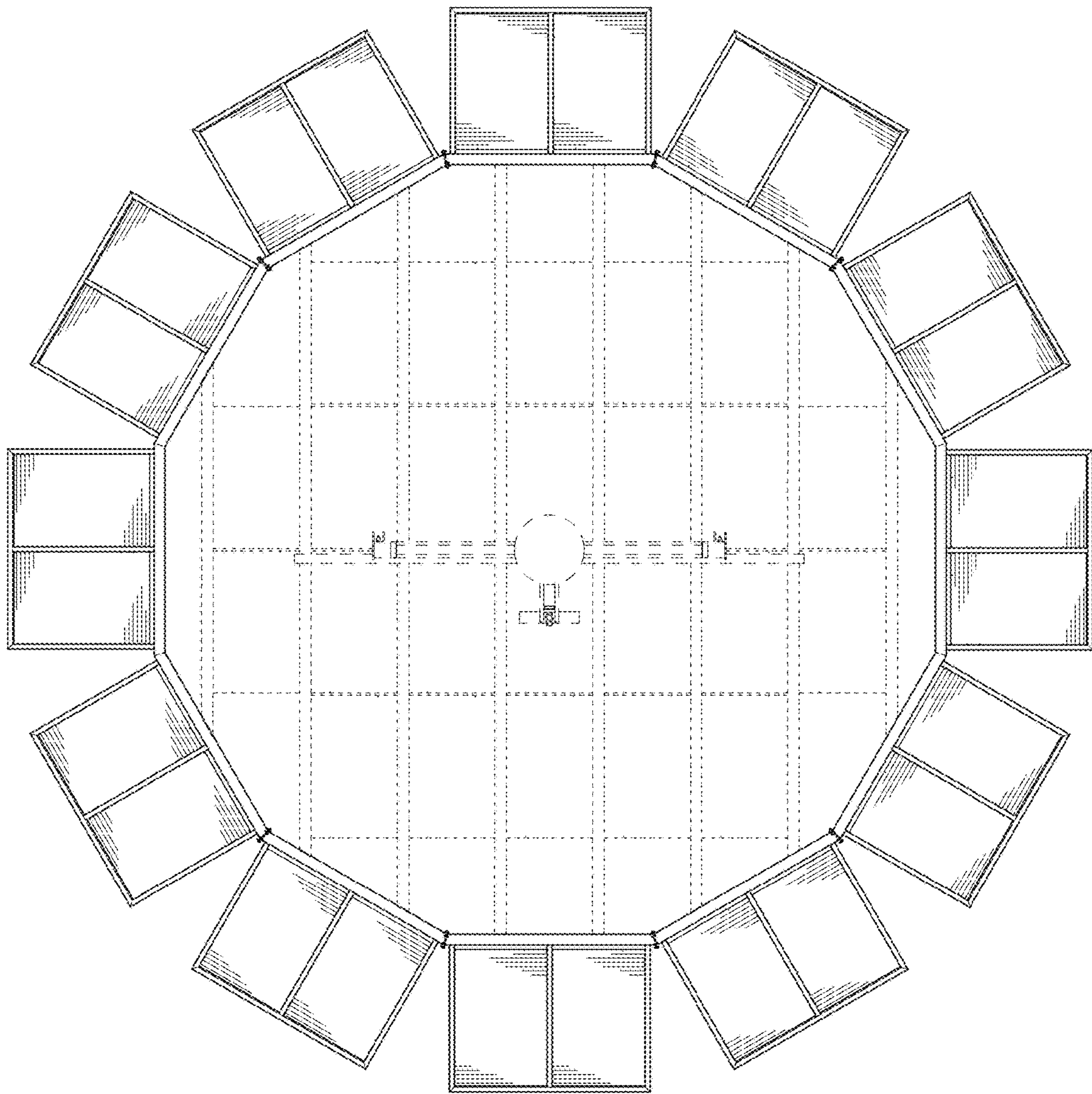

FIG. 56

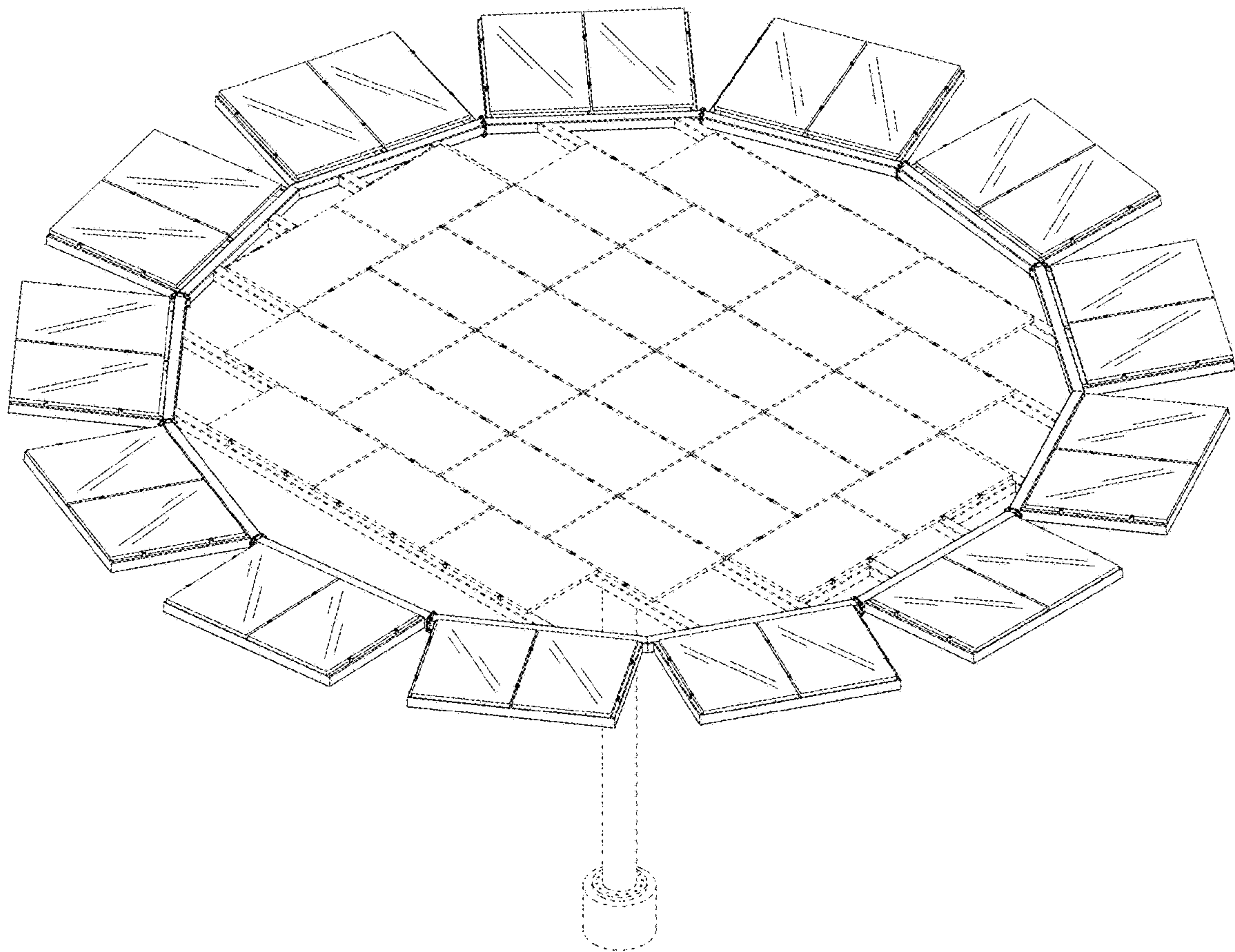

FIG. 57

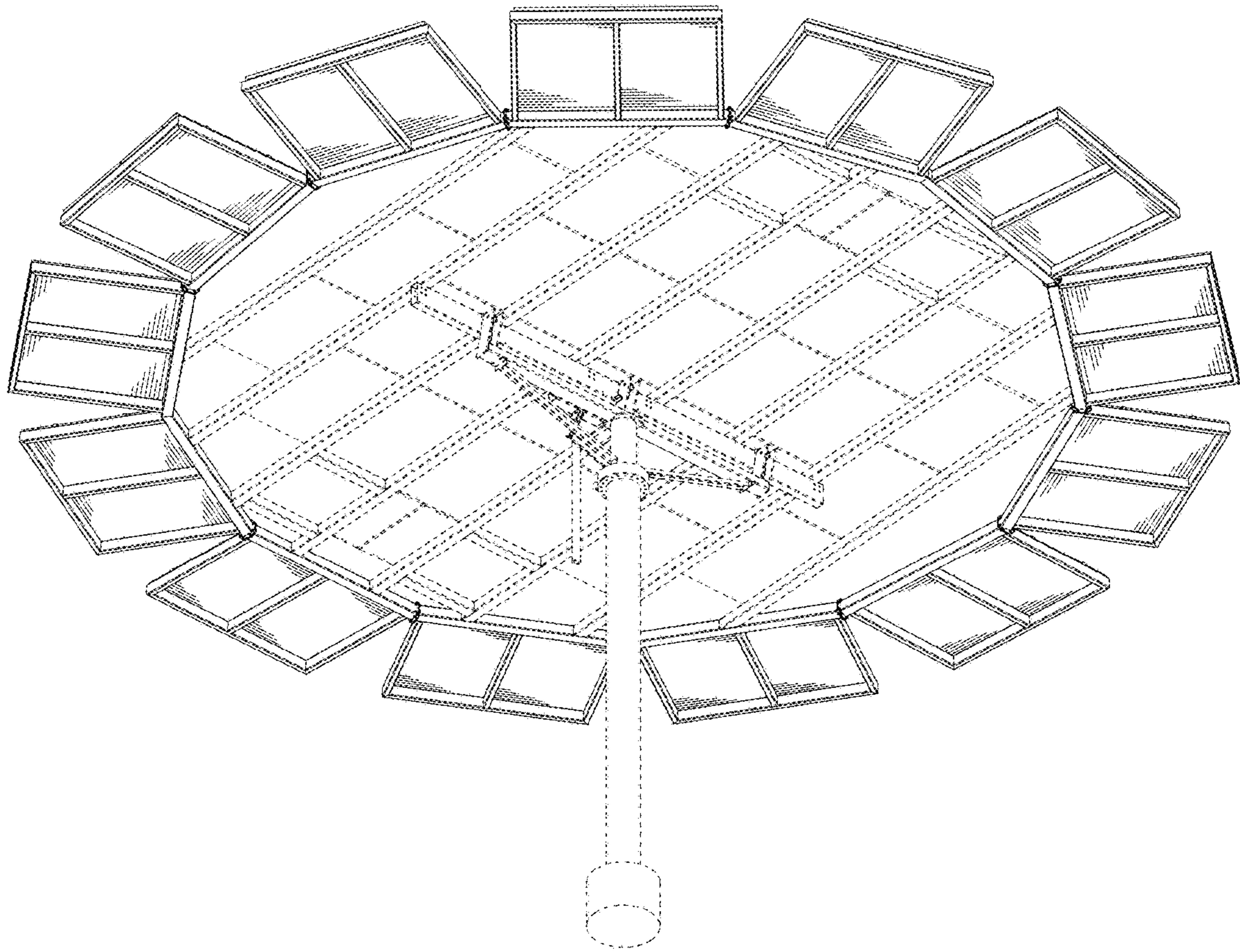

FIG. 58

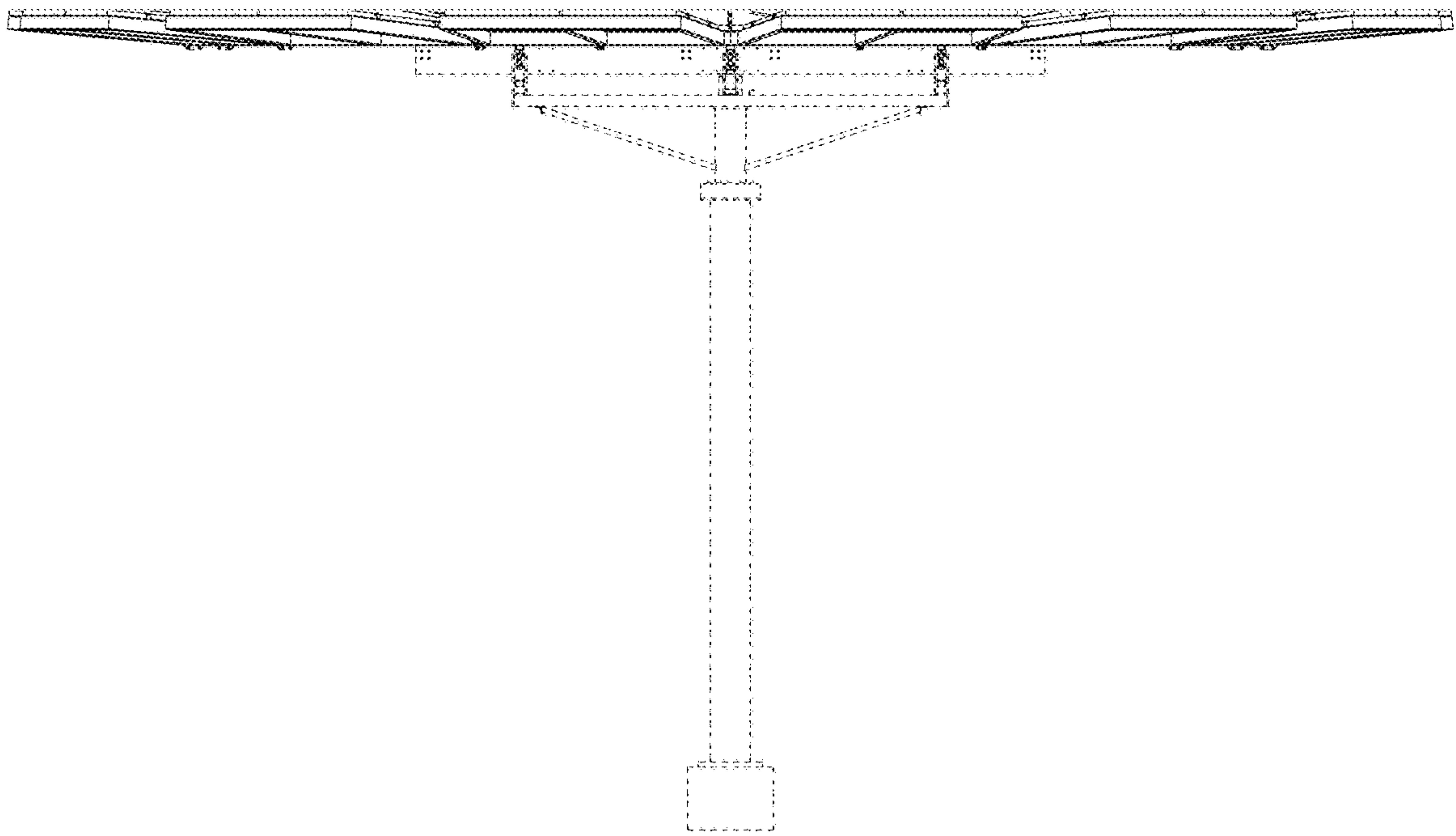

FIG. 59

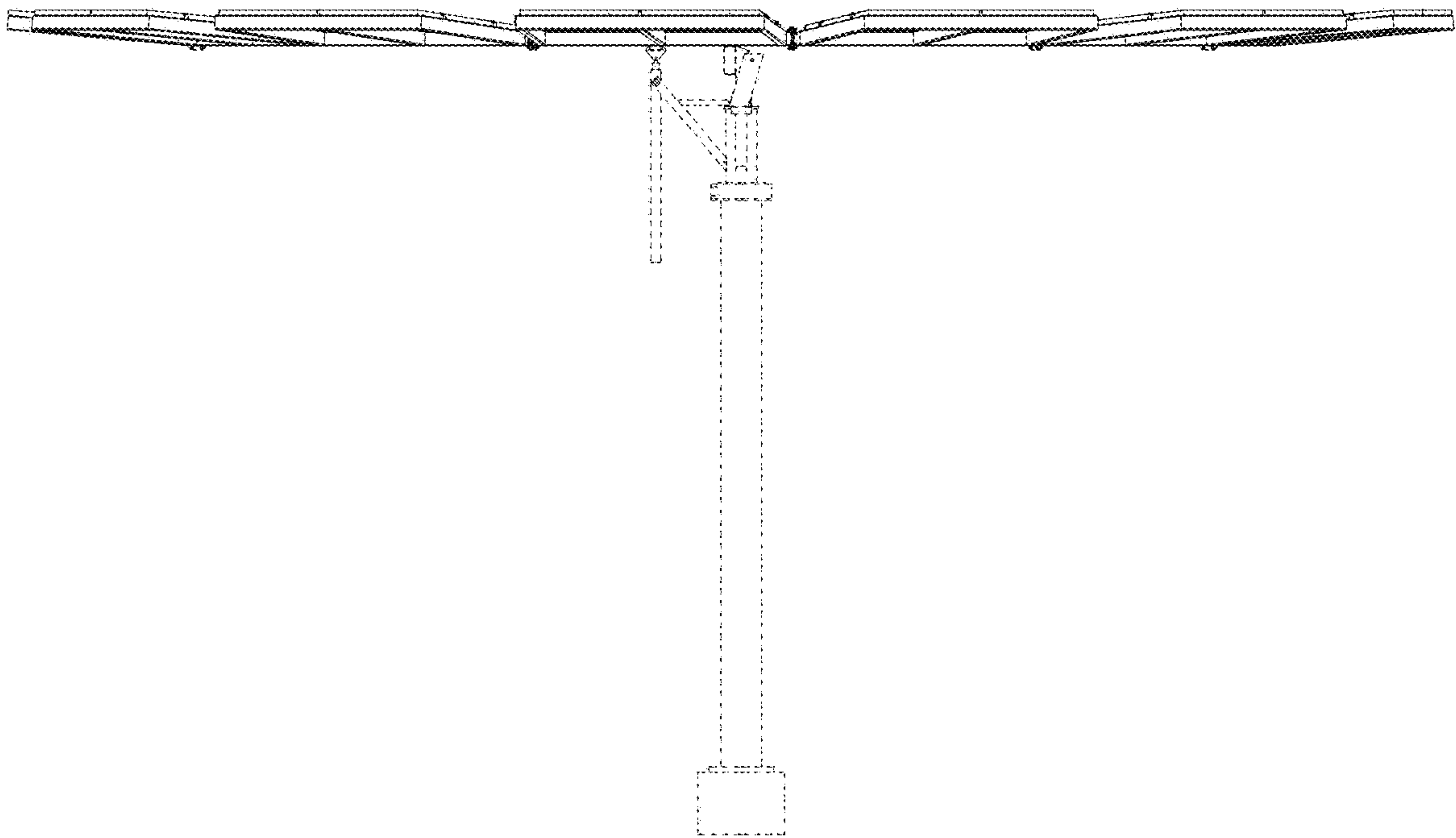

FIG. 60

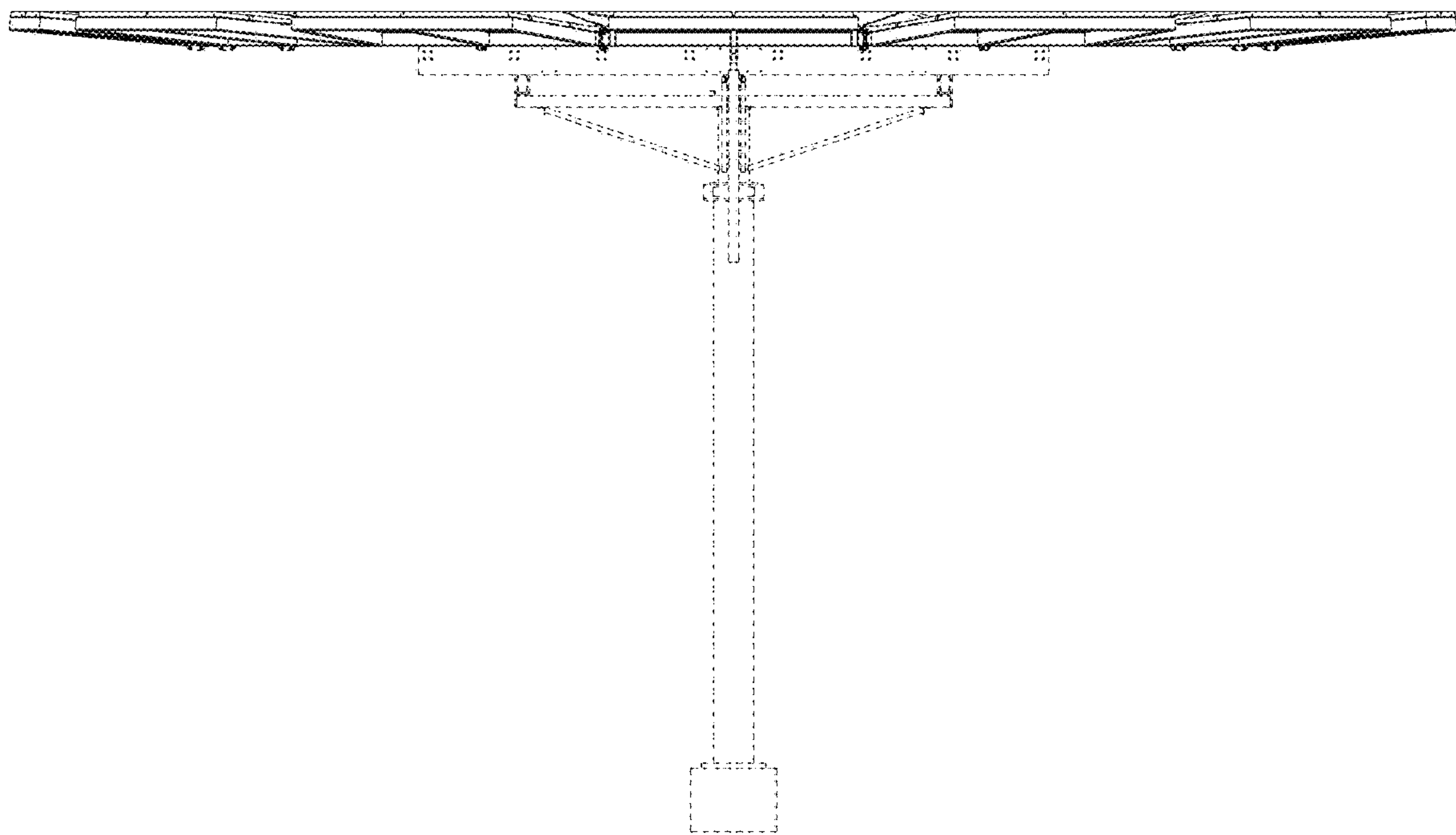

FIG. 61

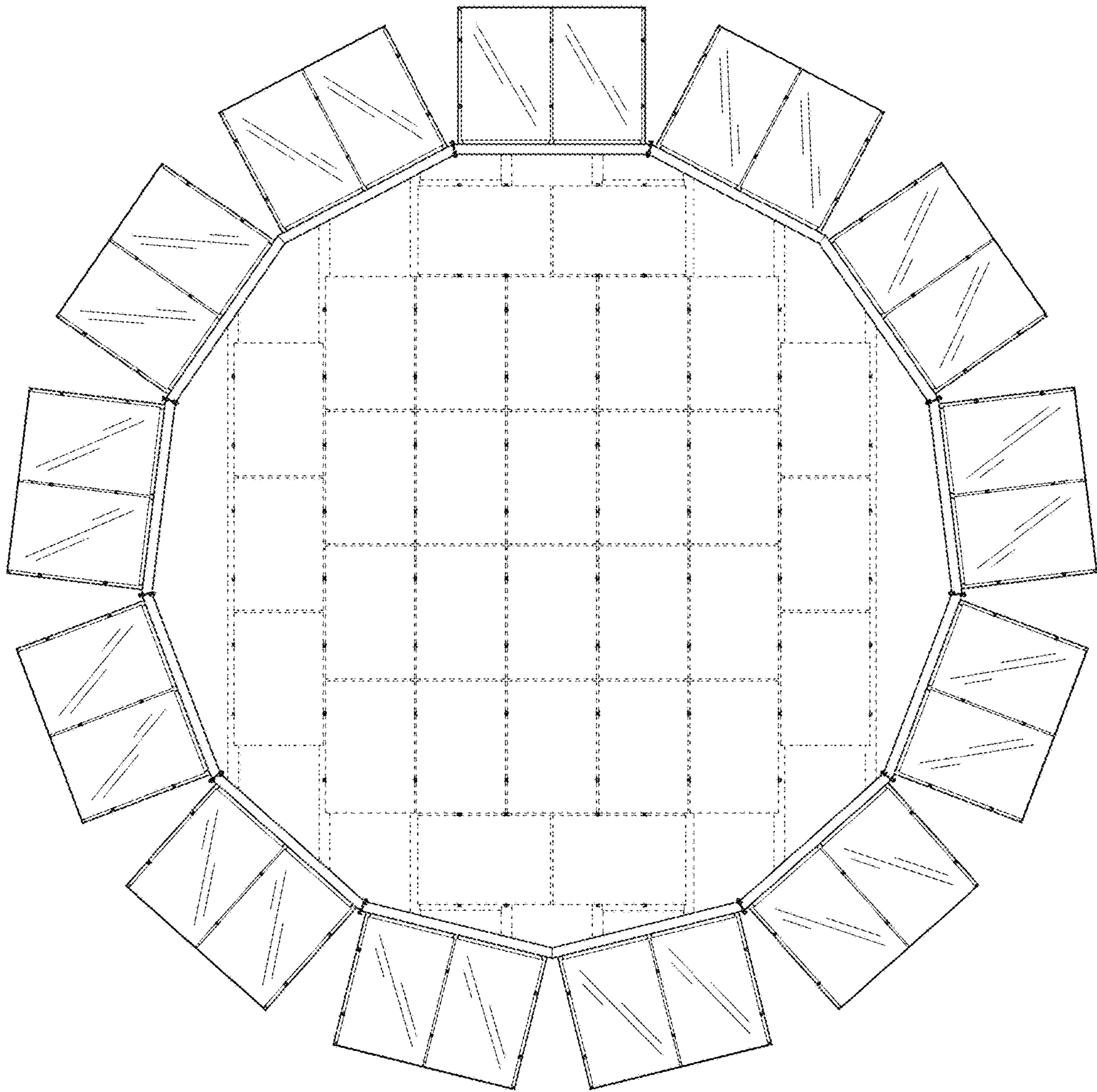

FIG. 62

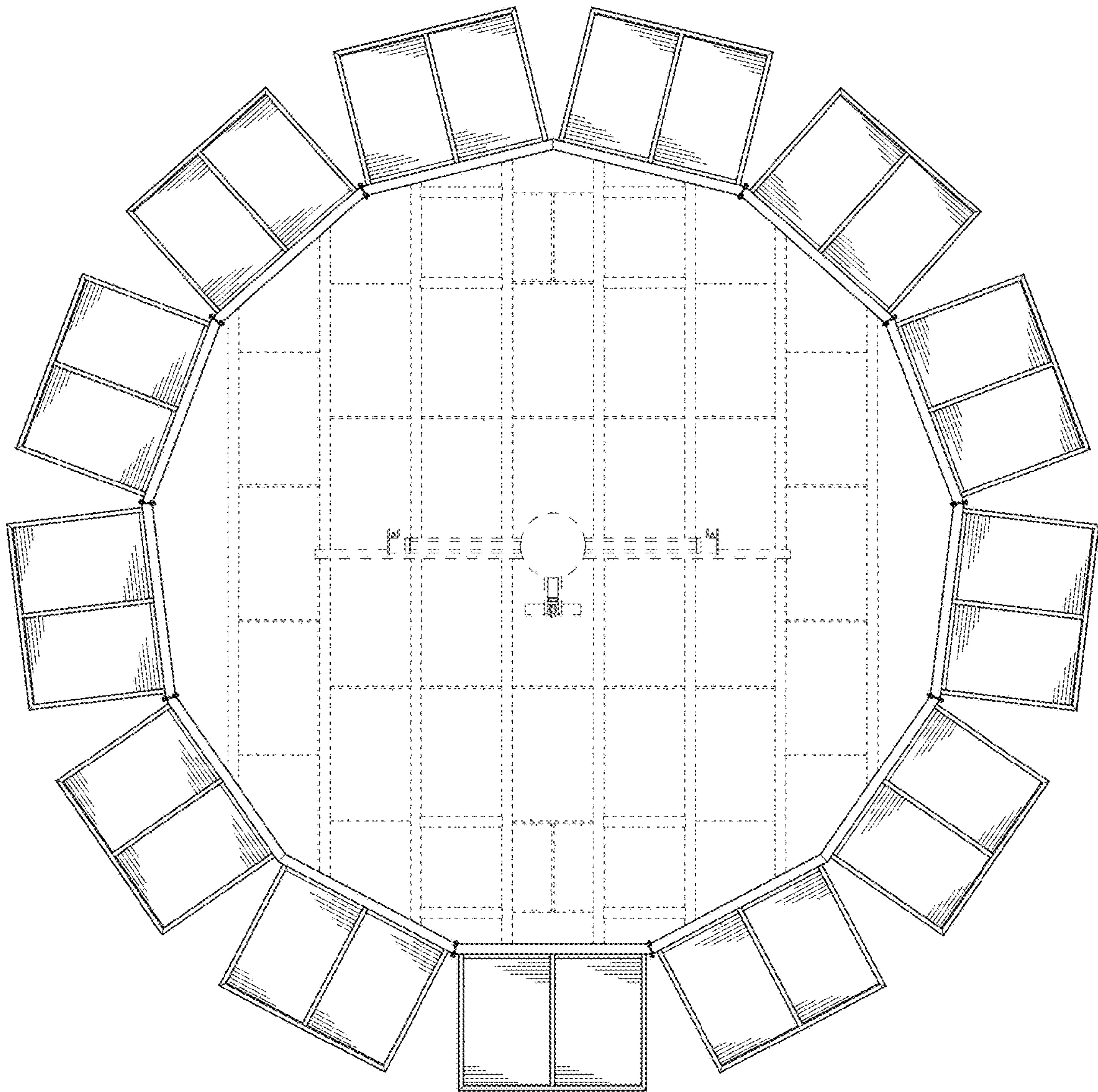

FIG. 63

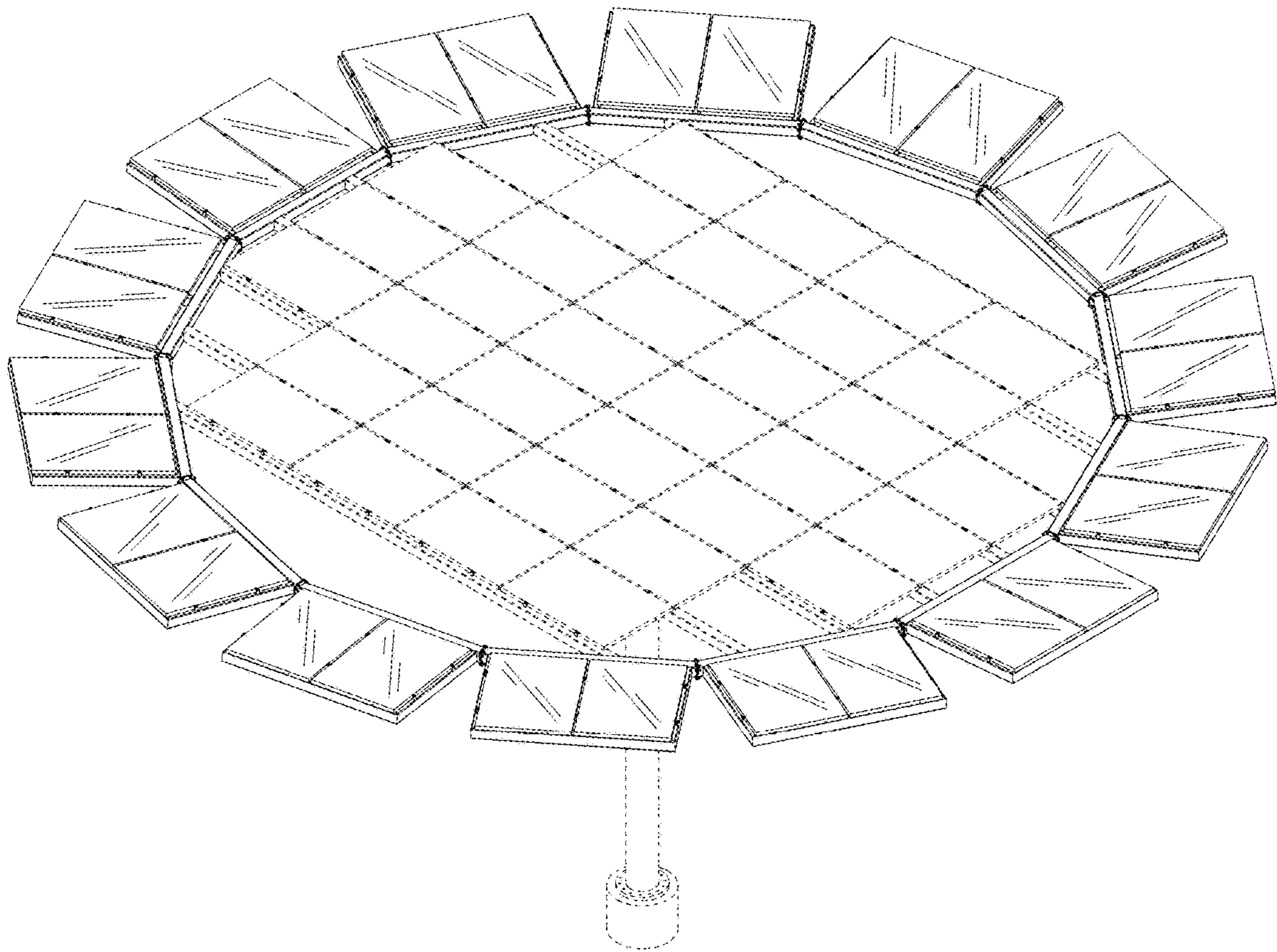

FIG. 64

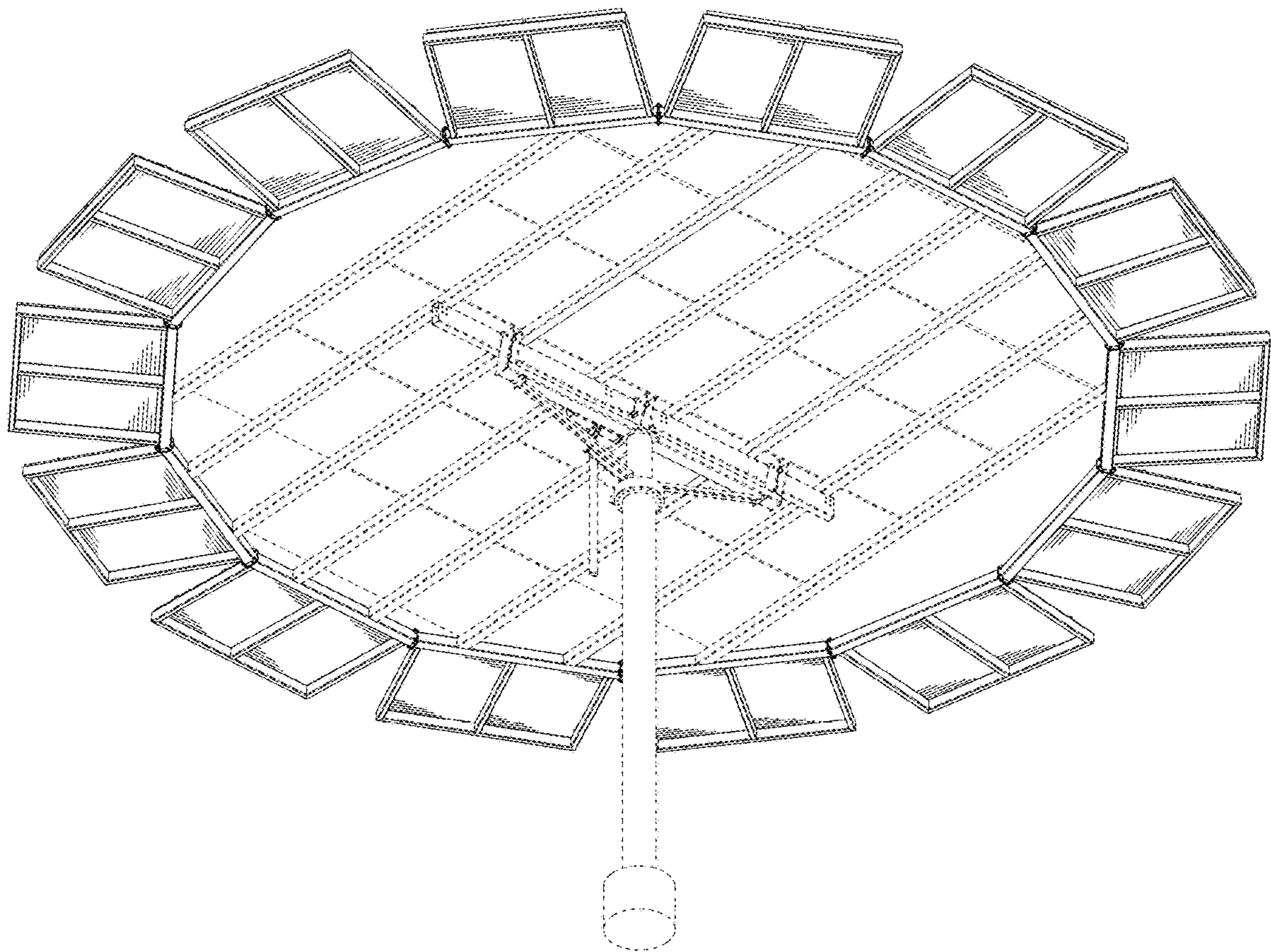

FIG. 65

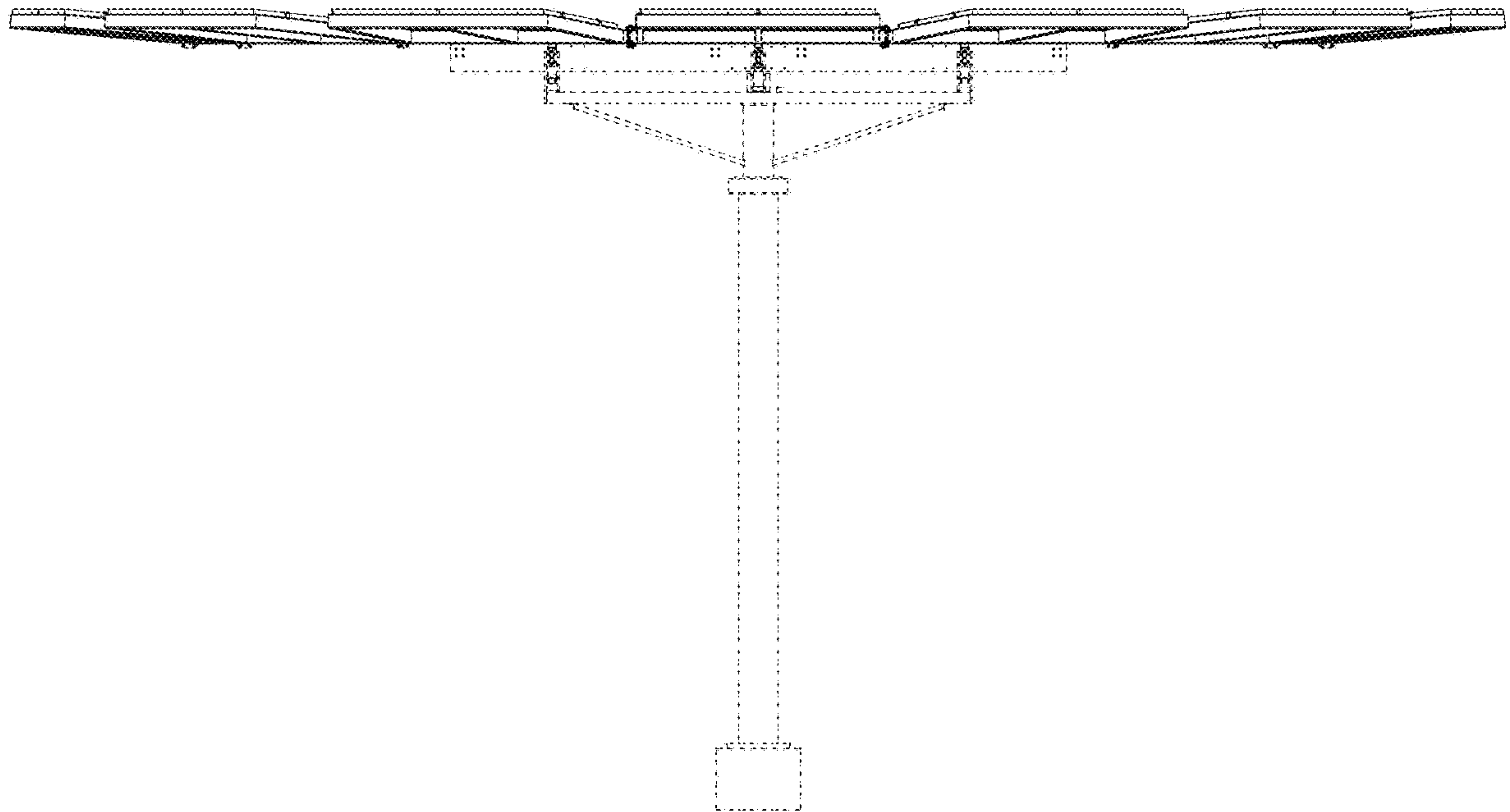

FIG. 66

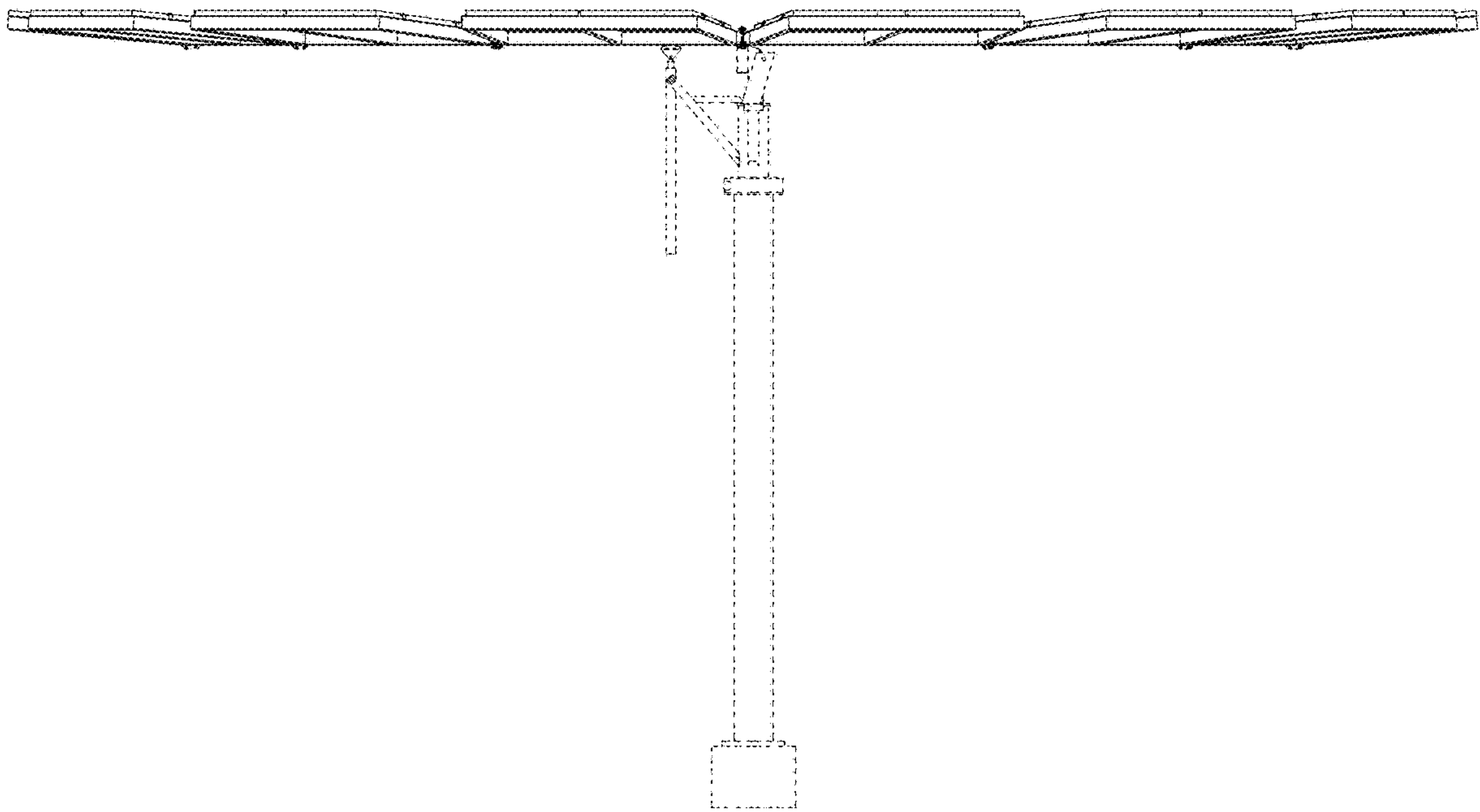

FIG. 67

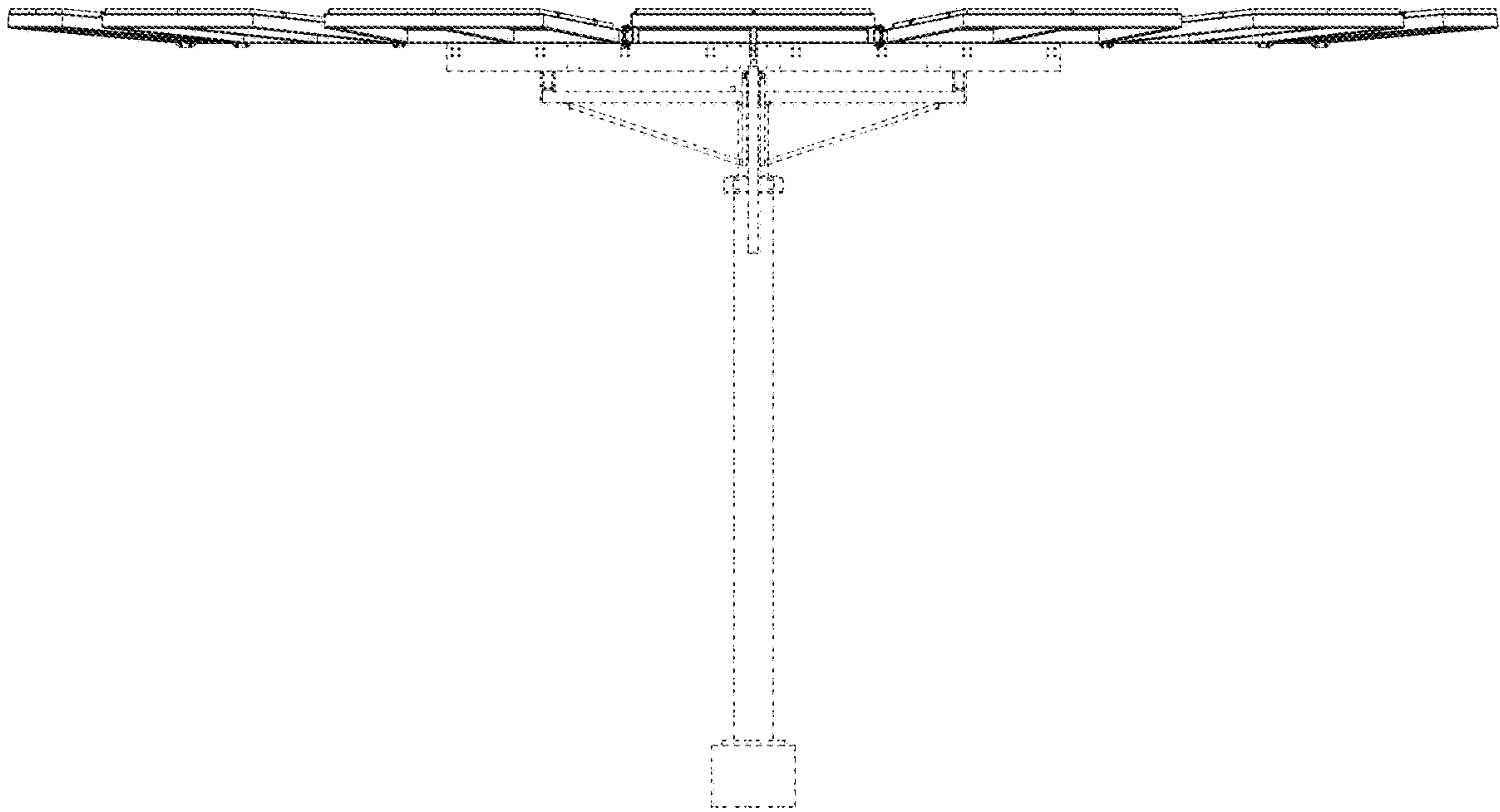

FIG. 68

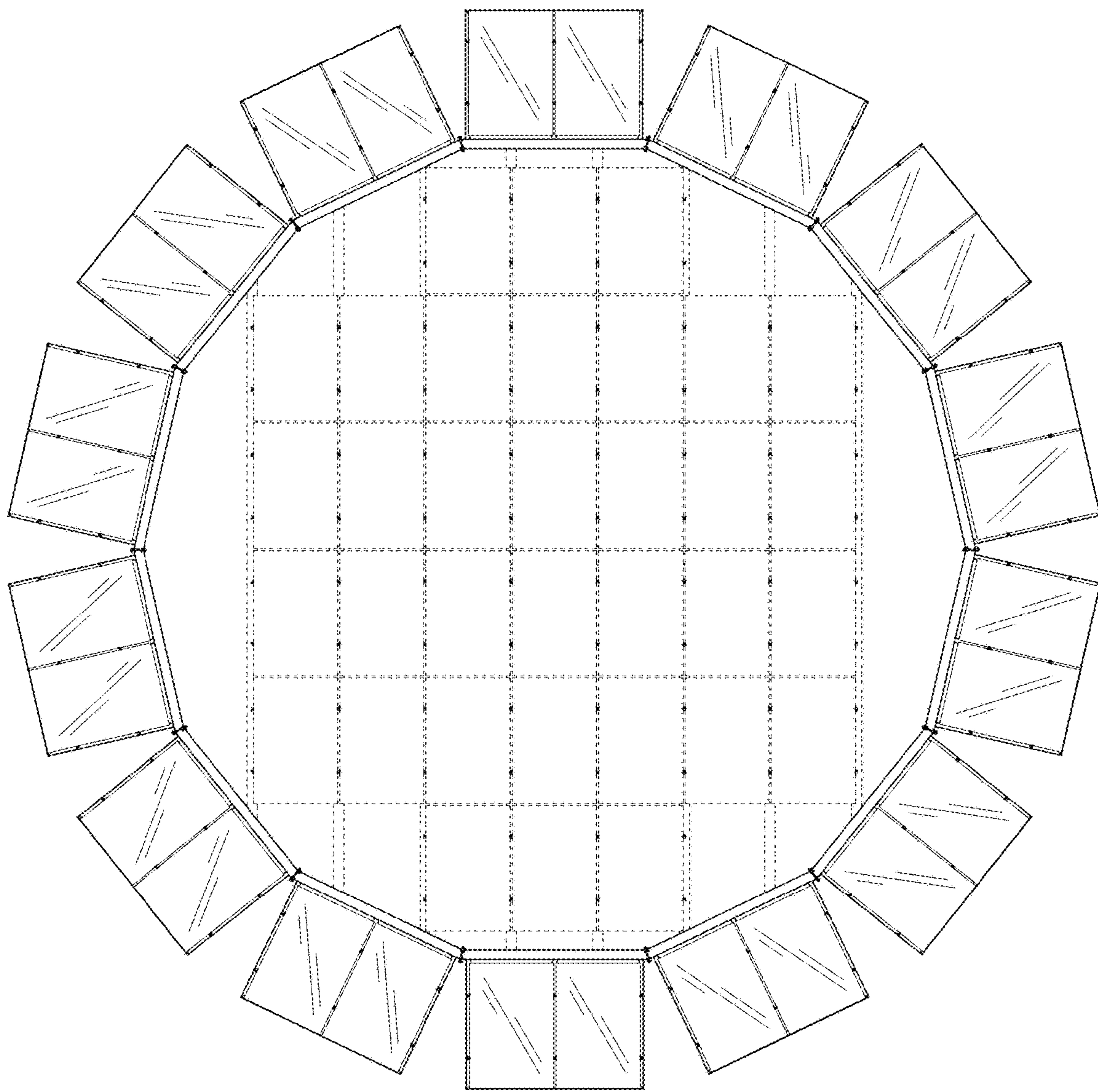

FIG. 69

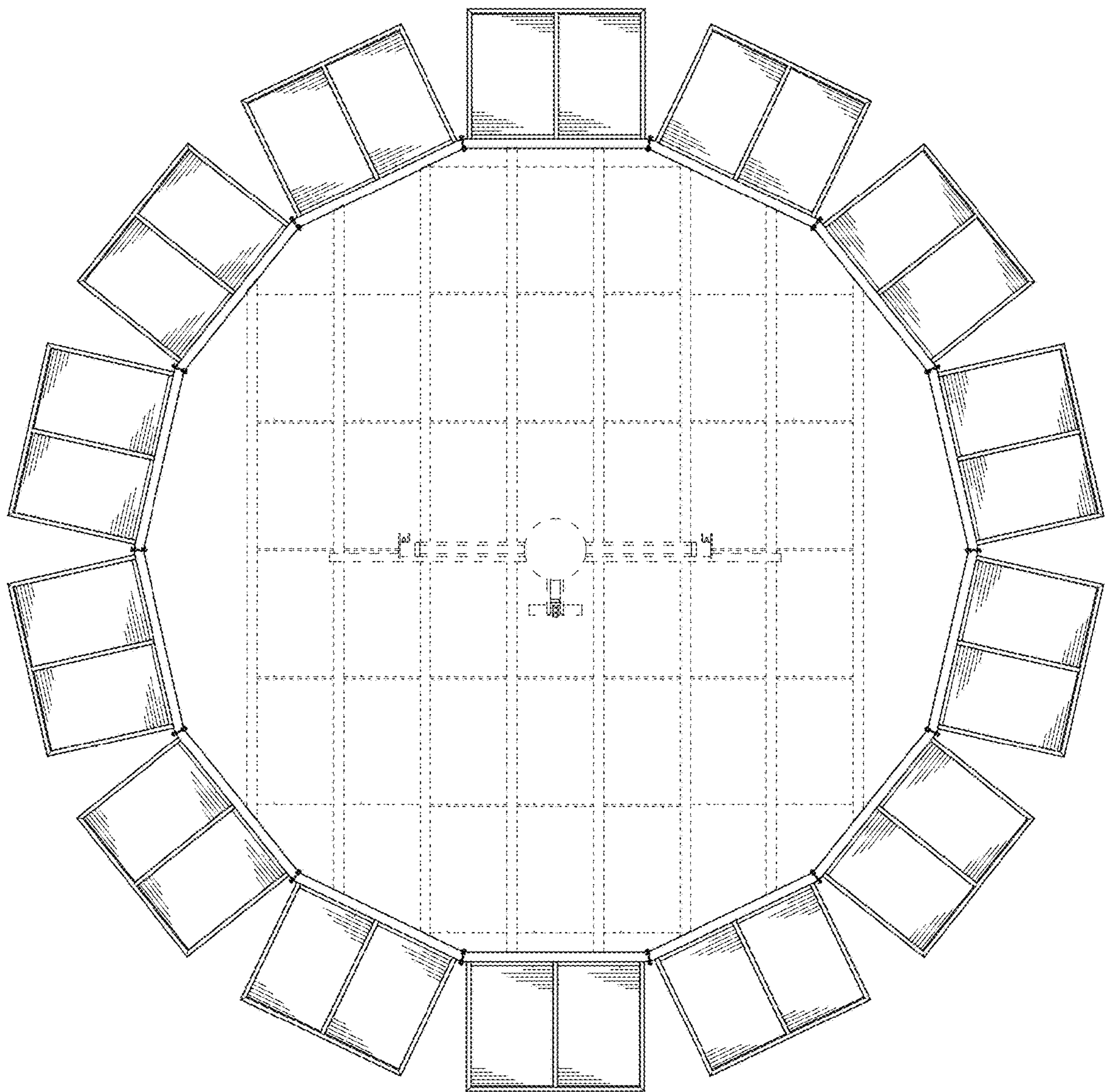

FIG. 70