



US00D817800S

(12) **United States Design Patent**  
**Silvestri**

(10) **Patent No.:** **US D817,800 S**  
(45) **Date of Patent:** **\*\* May 15, 2018**

- (54) **ARTICLE OF JEWELRY**
- (71) Applicant: **Bulgari S.p.A.**, Rome (IT)
- (72) Inventor: **Lucia Silvestri**, Rome (IT)
- (73) Assignee: **BULGARI S.P.A.**, Rome (IT)
- (\*\*) Term: **15 Years**

D606,894 S *	12/2009	Bulgari	.....	D11/5
D628,092 S *	11/2010	Bulgari	.....	D10/32
D763,118 S *	8/2016	Modi	.....	D11/89
D781,567 S *	3/2017	Silverman	.....	D2/976
2014/0352857 A1 *	12/2014	Warren	.....	A44C 17/0208 63/29.1

- (21) Appl. No.: **29/572,941**
- (22) Filed: **Aug. 1, 2016**

(30) **Foreign Application Priority Data**

Feb. 1, 2016 (WO) ..... 955381201

- (51) **LOC (11) Cl.** ..... **11-01**
- (52) **U.S. Cl.**  
USPC ..... **D11/1; D11/91**
- (58) **Field of Classification Search**  
USPC ..... D11/1-45, 48, 49, 63, 67, 68, 79-86,  
D11/89-92, 200, 238, 239, 241;  
D3/323-325; D2/976  
CPC ..... A44C 1/00; A44C 17/02; A44C 17/0208;  
A44C 17/04; A44C 17/046; A44C 25/00;  
A44C 25/001; A44C 5/00; A44C 5/0007;  
A44C 5/003; A44C 5/0084; A44C  
5/0092; A44C 5/14; A44C 7/00; A44C  
7/002; A44C 7/004; A44C 7/005; A44C  
7/006; A44C 9/00

See application file for complete search history.

(56) **References Cited**

**U.S. PATENT DOCUMENTS**

D441,005 S *	4/2001	Parham, Jr.	.....	D17/20
D498,169 S *	11/2004	Pinto	.....	D11/79
D505,092 S *	5/2005	Kothari	.....	D11/91
D510,540 S *	10/2005	Pinto	.....	D11/79
D583,274 S *	12/2008	Steshik	.....	D11/91
D583,276 S *	12/2008	Steshik	.....	D11/91
D584,183 S *	1/2009	Steshik	.....	D11/91
D606,886 S *	12/2009	Bulgari	.....	D10/32

**OTHER PUBLICATIONS**

High Jewelry—Serpenti Collection, Bvlgari website, published on Jul. 4, 2016, online. Site visited on Jun. 20, 2017. Internet URL:<“https://web.archive.org/web/20160704080707/https://www.bulgari.com/en-us/products.html?root\_level=861&sign=106”>.\*

Vintage Serpenti Bracelet by Bvlgari, Sandra’s Closet blog, published on Jun. 17, 2012, online. Site visited Jun. 23, 2017. Internet URL:<“http://www.sandrascloset.com/tag/snake-bracelet-in-gold-and-polychrome-enamel/”>.\*

\* cited by examiner

*Primary Examiner* — Cynthia Ramirez

*Assistant Examiner* — Llorellys Martinez-Rivera

(74) *Attorney, Agent, or Firm* — Stephen Kenny; Peter Sullivan; Foley Hoag LLP

(57) **CLAIM**

The ornamental design for an article of jewelry, as shown and described.

**DESCRIPTION**

FIG. 1 is a perspective view of the article of jewelry showing my new design.

FIG. 2 is a front elevation view thereof.

FIG. 3 is a back elevation view thereof.

FIG. 4 is a left side elevation view thereof.

FIG. 5 is a right side elevation view thereof.

FIG. 6 is a top plan view thereof; and,

FIG. 7 is a bottom plan view thereof.

The broken lines in the drawings illustrate portions of the article of jewelry that form no part of the claimed design.

**1 Claim, 7 Drawing Sheets**

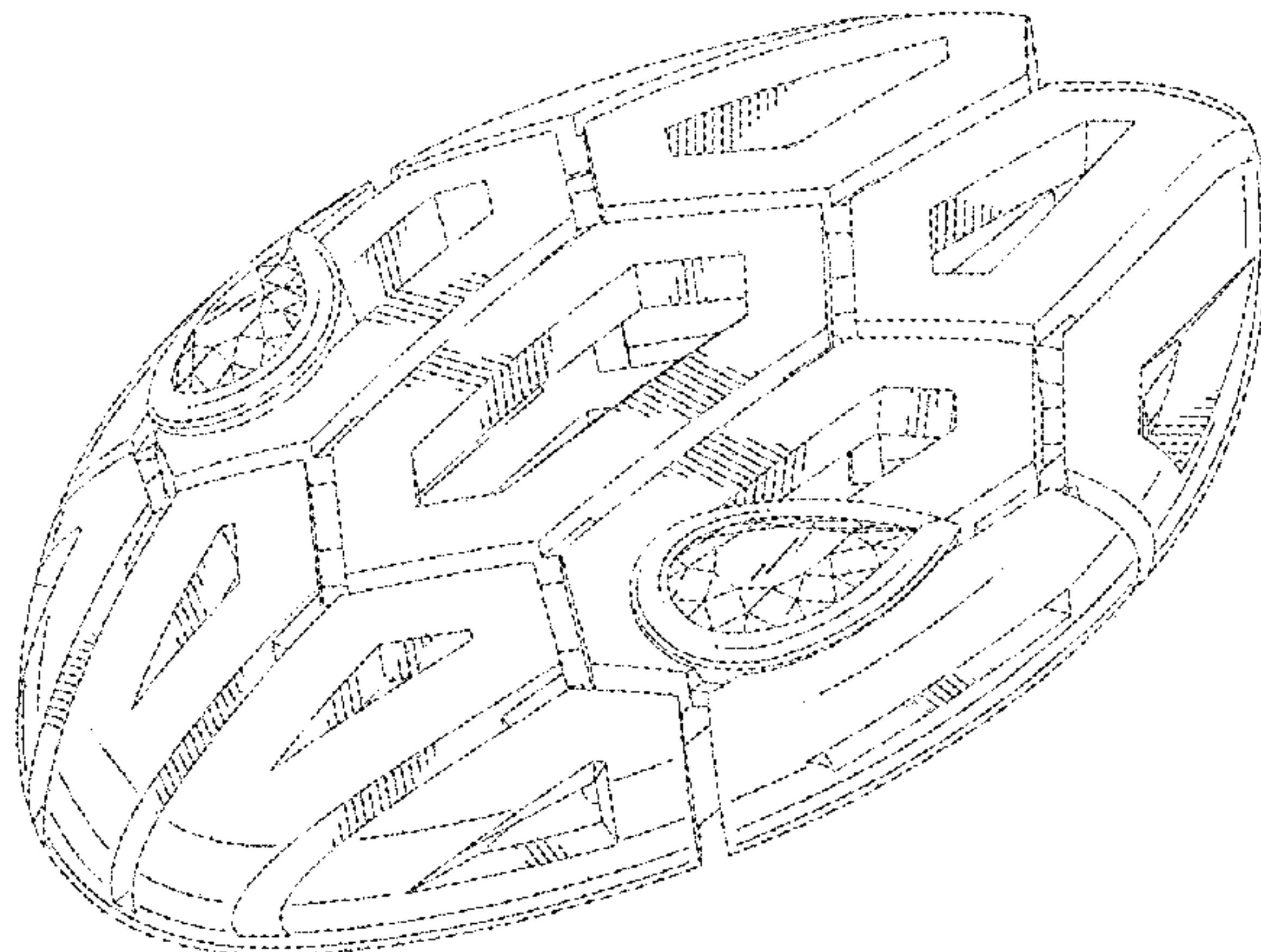

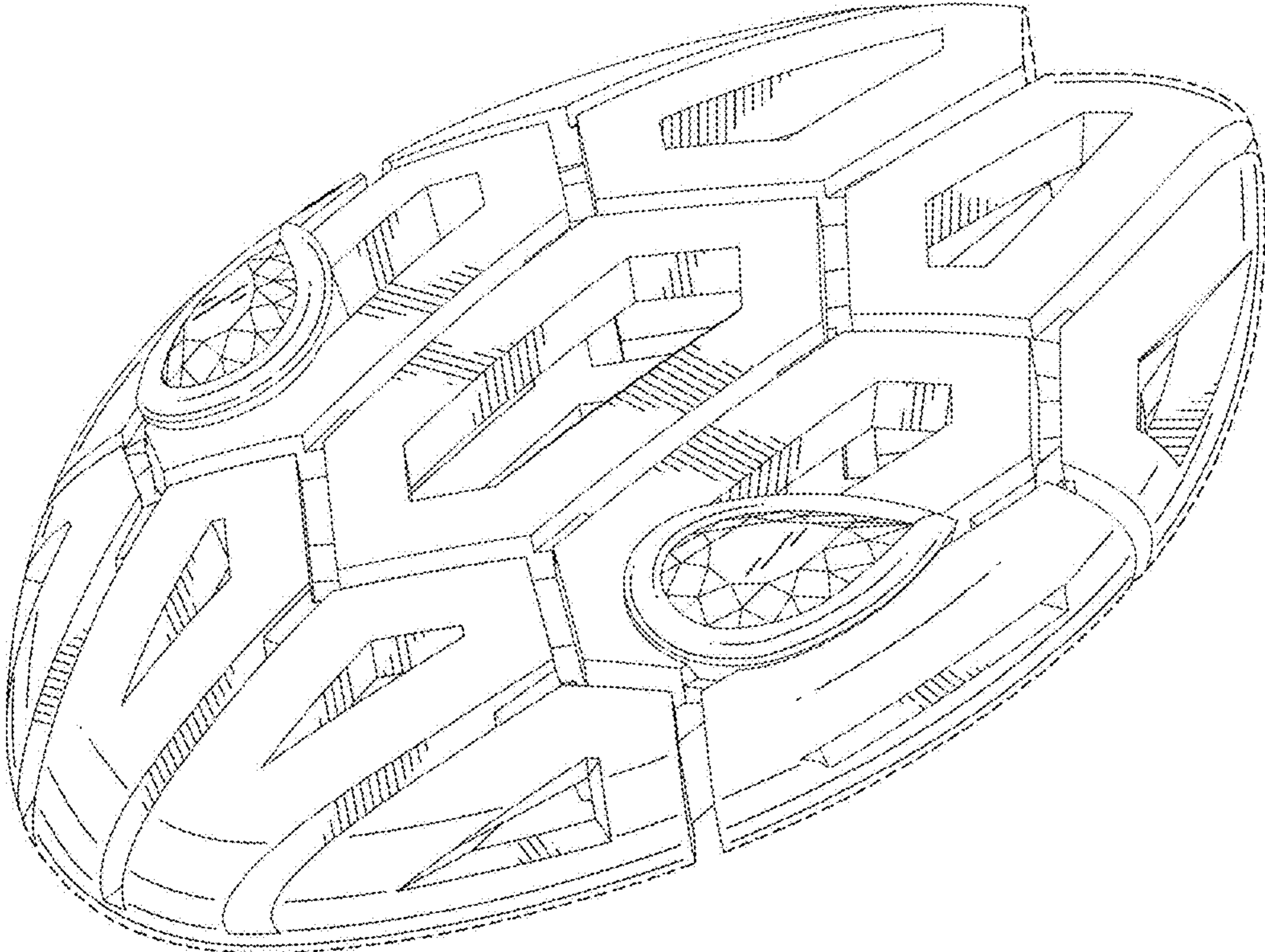

FIG. 1

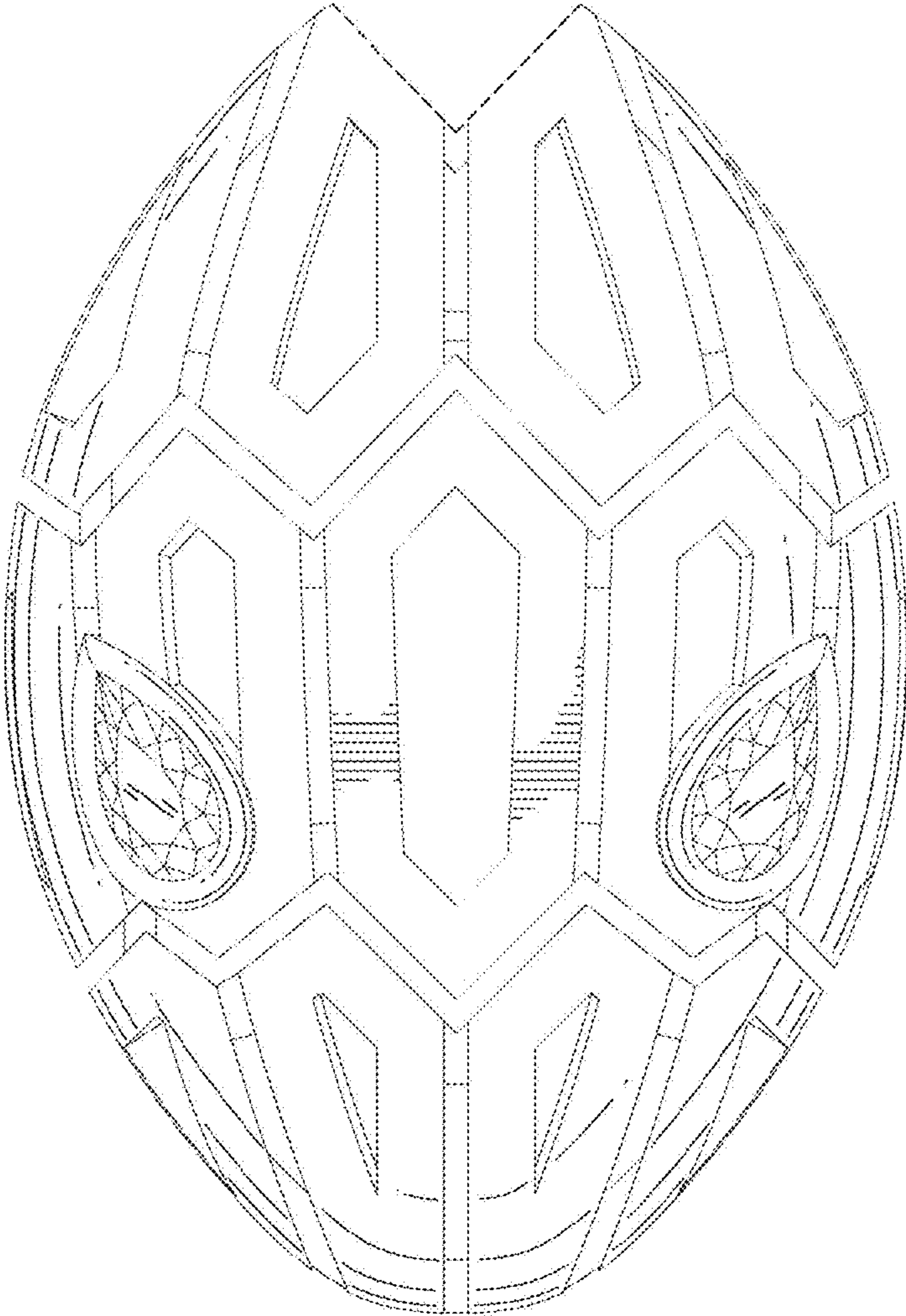

FIG. 2



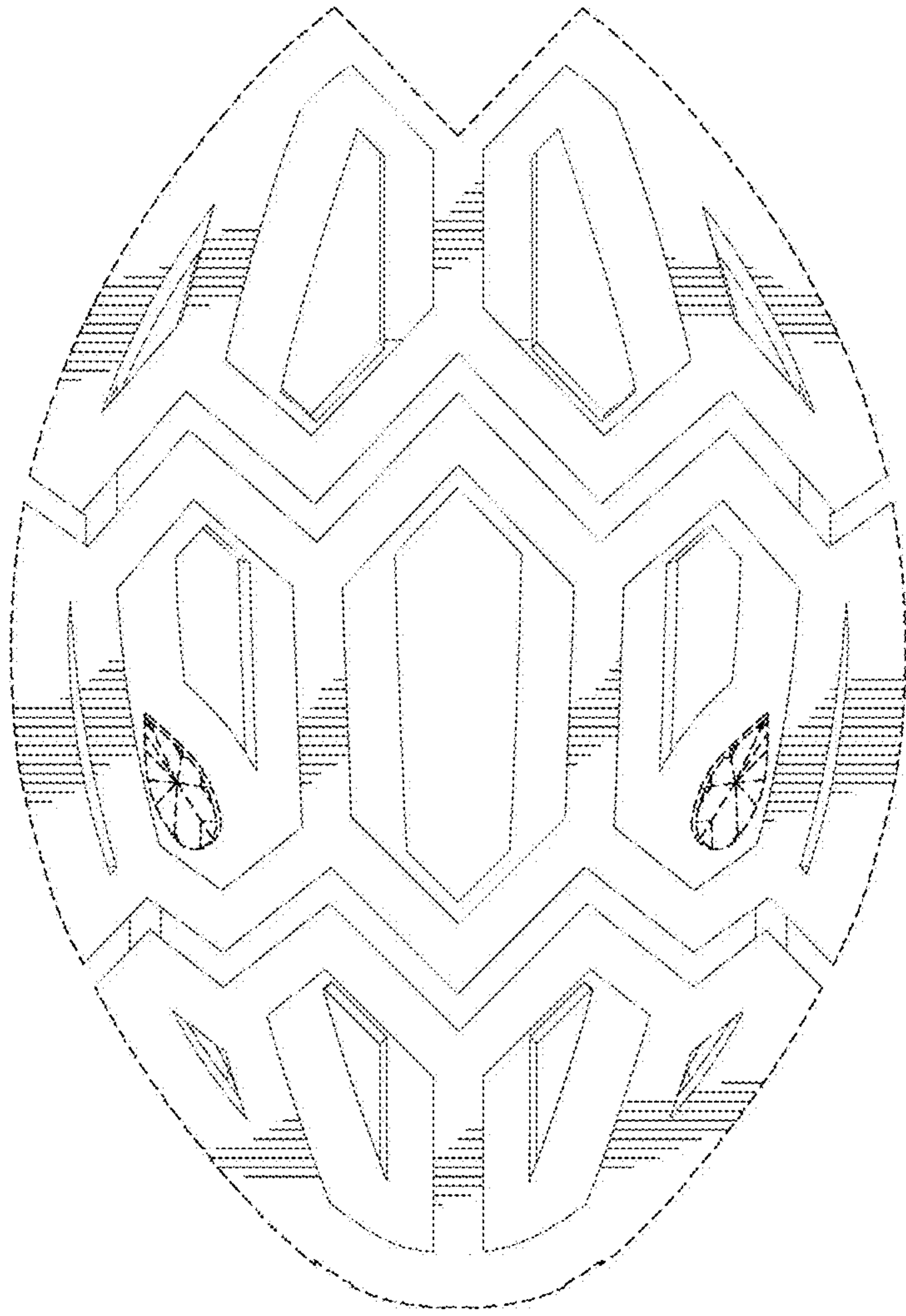

FIG. 3

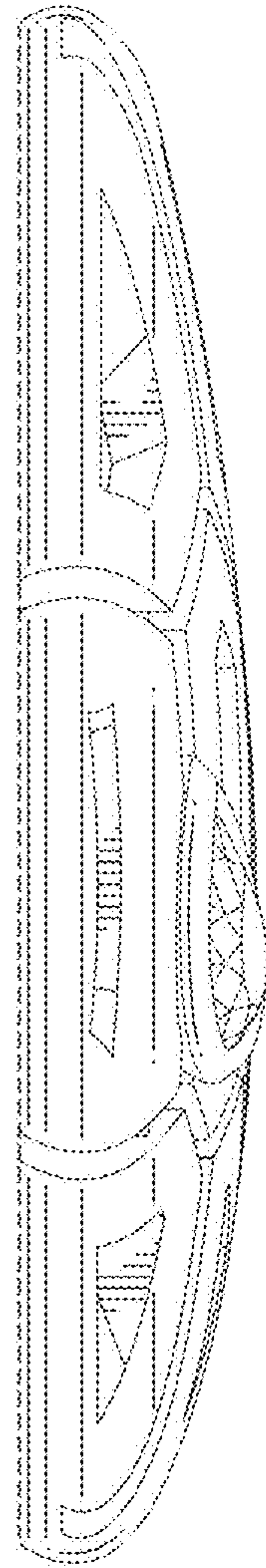

FIG. 4

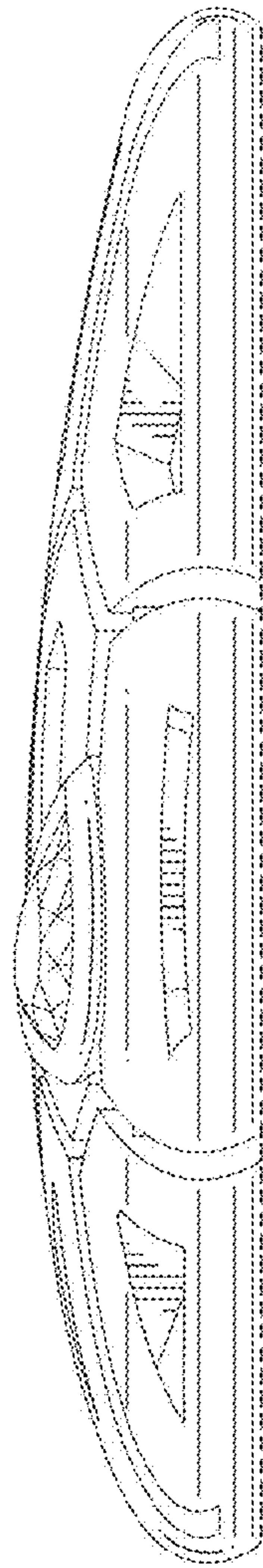

FIG. 5

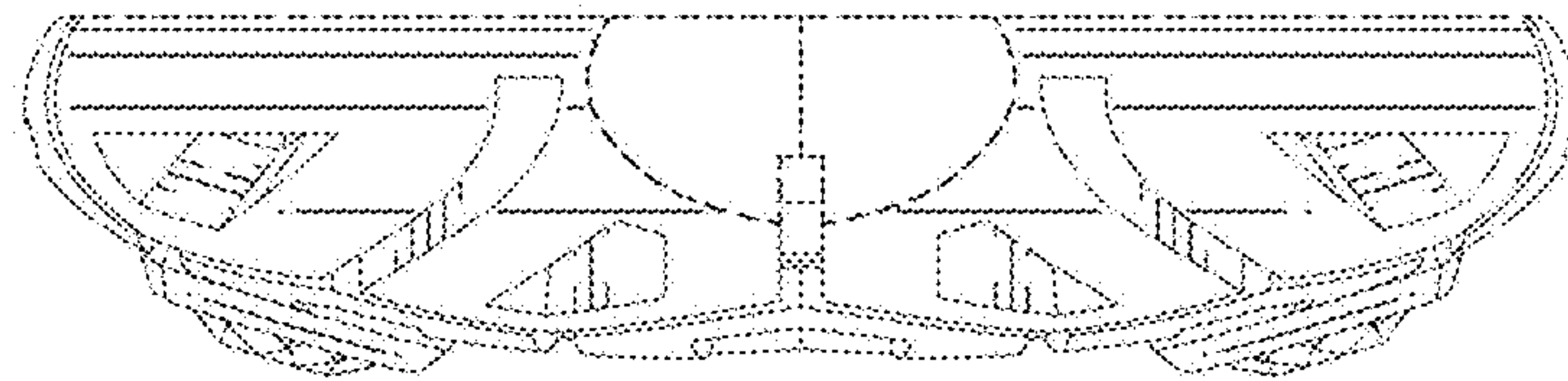

FIG. 6

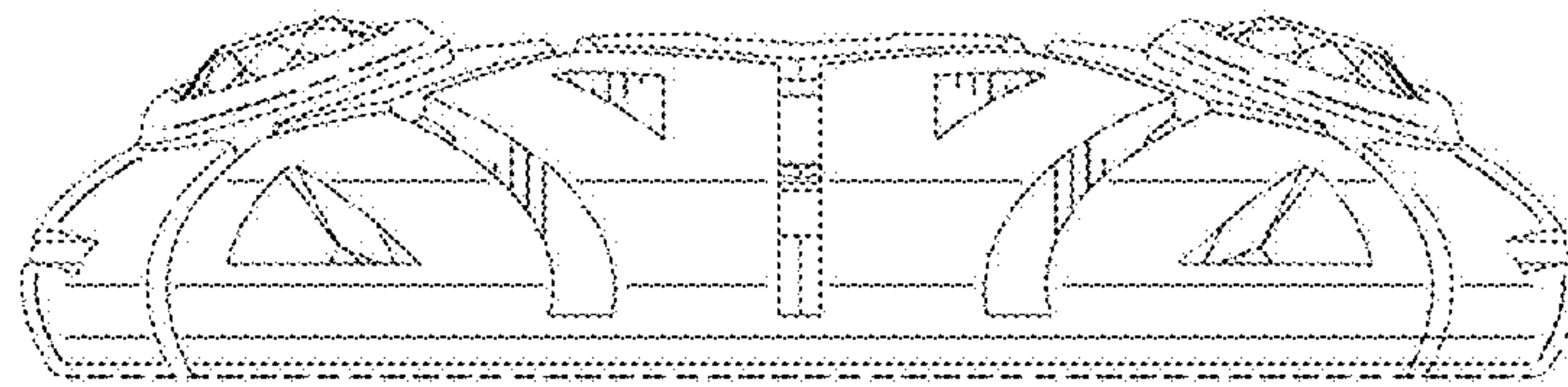

FIG. 7