



US00D817723S

(12) **United States Design Patent**  
**Elattrache**

(10) **Patent No.:** **US D817,723 S**

(45) **Date of Patent:** **\*\* May 15, 2018**

(54) **COMBINED SILVERWARE STAND AND BROCHURE**

D689,744 S \* 9/2013 Tarantino ..... D19/86  
D705,018 S \* 5/2014 Liotta ..... D7/601  
D740,619 S \* 10/2015 Elliott ..... D7/637

(71) Applicant: **Michael Elattrache**, Van Nuys, CA  
(US)

**OTHER PUBLICATIONS**

(72) Inventor: **Michael Elattrache**, Van Nuys, CA  
(US)

Uten-sil fork and knife rest, announced Feb. 2014, [online], site visited Aug. 23, 2017. Available from Internet, <URL: <http://www.uten-sil.blogspot.com>>.\*

(\*\*) Term: **15 Years**

\* cited by examiner

(21) Appl. No.: **29/571,544**

*Primary Examiner* — Derrick E Holland

*Assistant Examiner* — Janice Julia Patyk

(22) Filed: **Jul. 19, 2016**

(74) *Attorney, Agent, or Firm* — QuickPatents, LLC;  
Kevin Prince

(51) **LOC (11) Cl.** ..... **07-99**

(52) **U.S. Cl.**  
USPC ..... **D7/638**

(57) **CLAIM**

(58) **Field of Classification Search**  
USPC ..... D7/637-641; 30/298.4; 211/60.1, 70.6,  
211/70.7; 248/37.3, 37.6  
CPC ..... A47F 7/00; A47G 21/00; A47G 21/14;  
A47B 88/20; B26B 3/00  
See application file for complete search history.

I claim the ornamental design for a combined silverware stand and brochure, as shown and described.

**DESCRIPTION**

(56) **References Cited**

**U.S. PATENT DOCUMENTS**

- 3,370,368 A \* 2/1968 Paschal ..... B42D 5/043  
248/459
- 4,770,379 A \* 9/1988 Estvold ..... A47K 1/09  
211/65
- D304,206 S \* 10/1989 Sawatsky ..... D19/75
- D361,019 S \* 8/1995 Voglis ..... D7/633
- D366,990 S \* 2/1996 Cheung ..... D7/637
- D398,429 S \* 9/1998 LeBlanc ..... D34/6
- 7,228,976 B2 \* 6/2007 Pretorius ..... A47K 1/09  
211/65
- D617,609 S \* 6/2010 Thomas ..... D7/601

FIG. 1 is a perspective view of a combined silverware stand and brochure, showing my new design; FIG. 2 is a front elevational view of FIG. 1; FIG. 3 is a rear elevational view of FIG. 1; FIG. 4 is a right-side elevational view of FIG. 1, the left-side elevational view being a mirror image thereof; FIG. 5 is a top plan view of FIG. 1; FIG. 6 is a bottom plan view of FIG. 1; and, FIG. 7 is a bottom plan view thereof, shown in unfolded condition.

The broken lines showing eating utensils in FIG. 1 depict environmental matter and form no part of the claimed design. The broken lines in FIGS. 6 and 7 depict portions of the combined silverware stand and brochure that form no part of the claimed design.

**1 Claim, 6 Drawing Sheets**

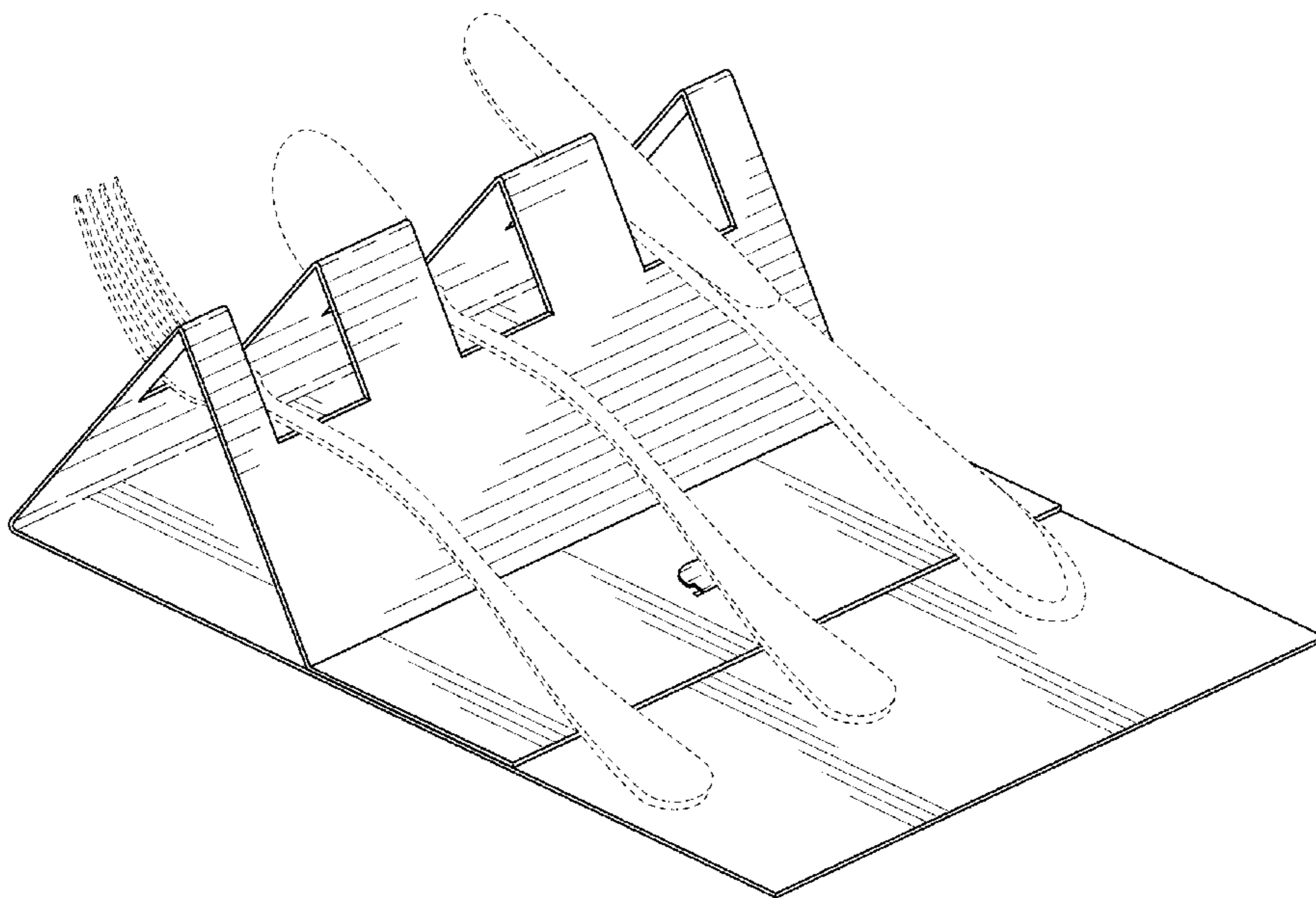

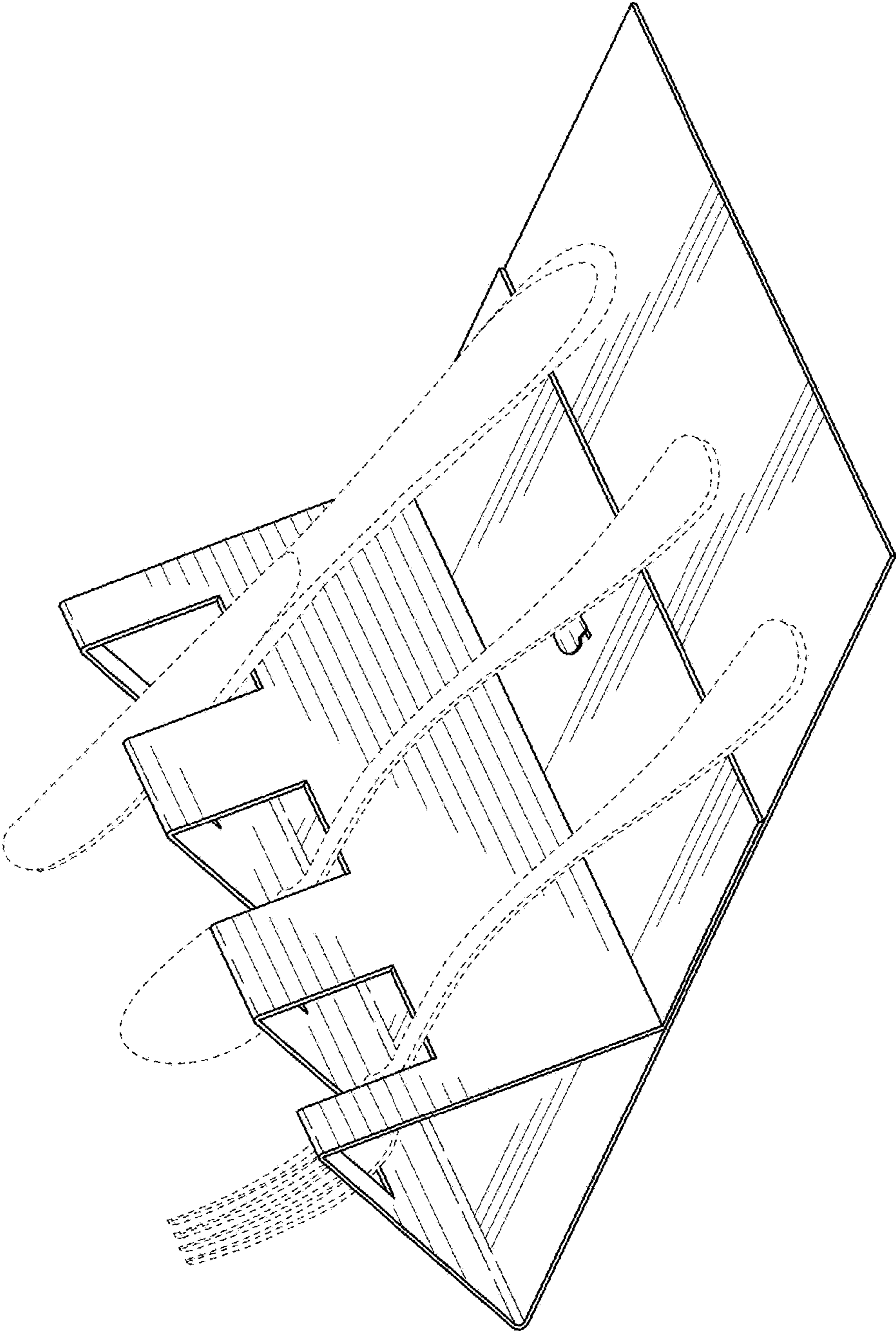

FIG. 1

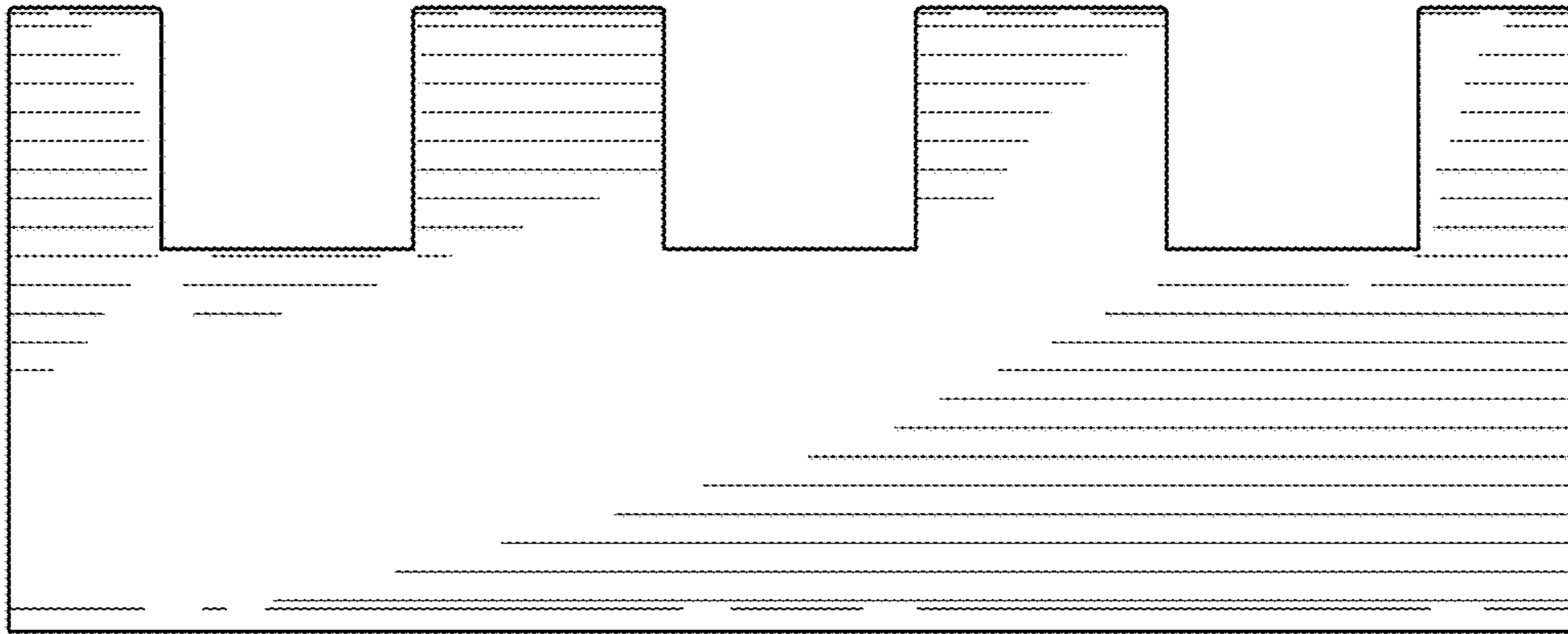

FIG. 2

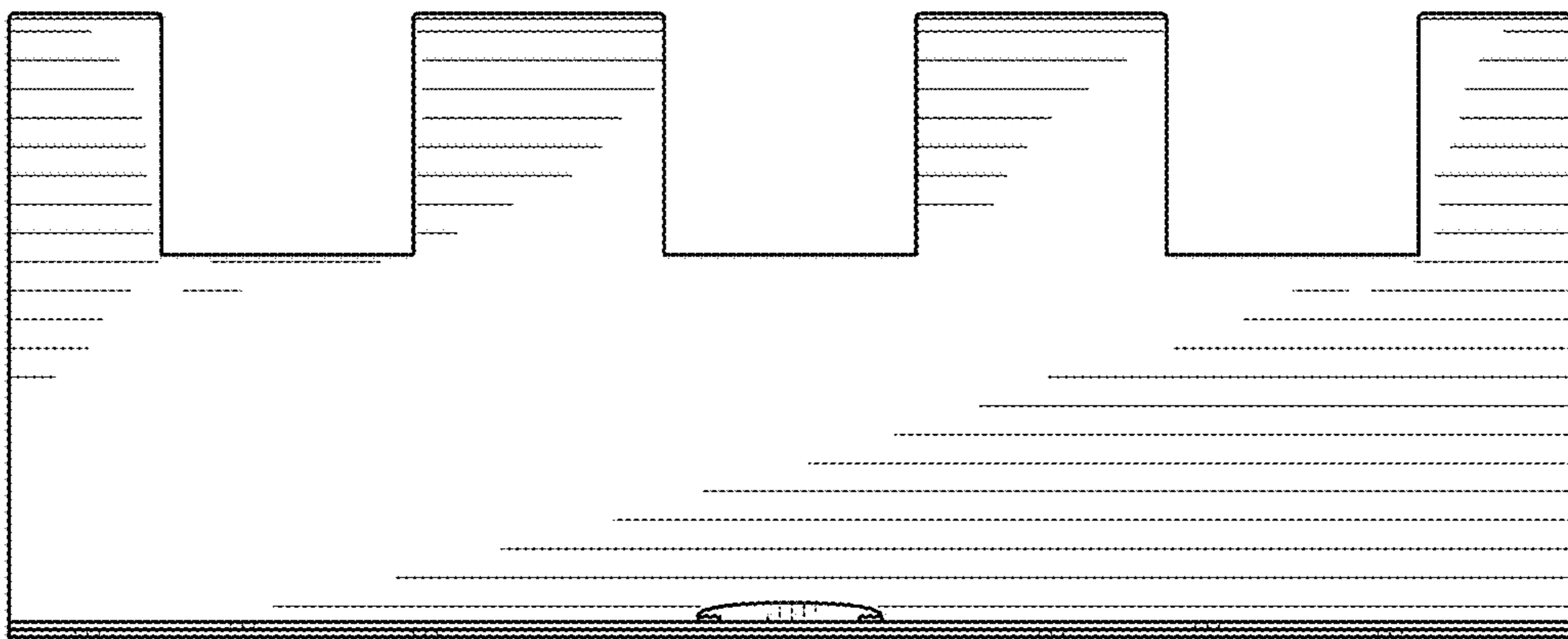

FIG. 3

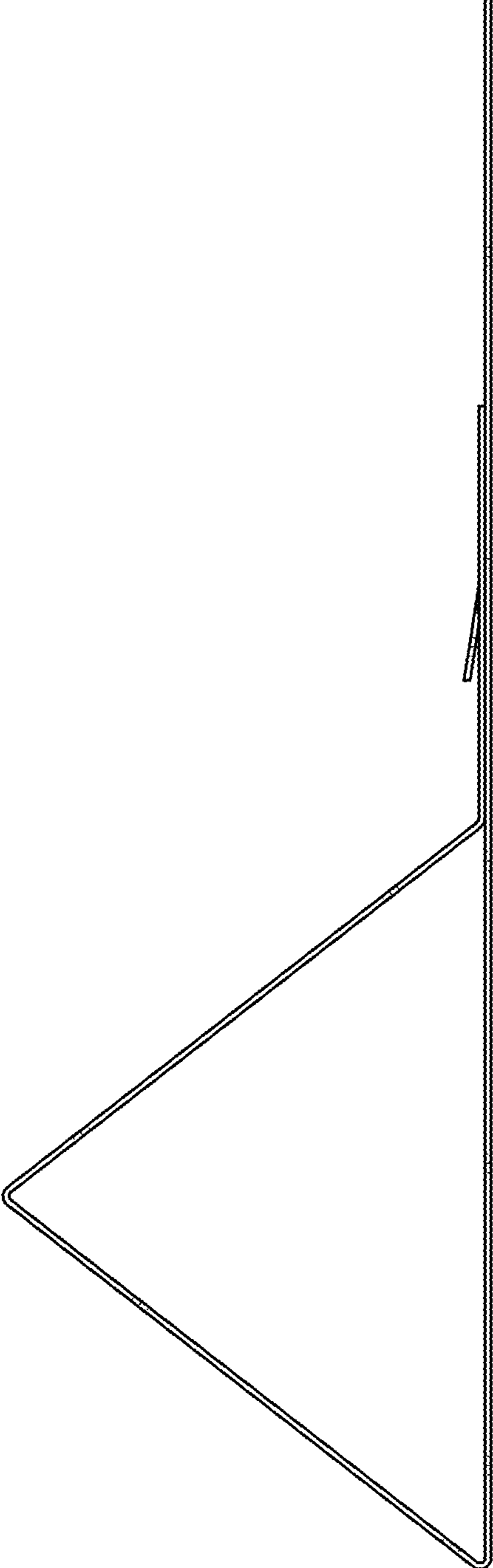

FIG. 4

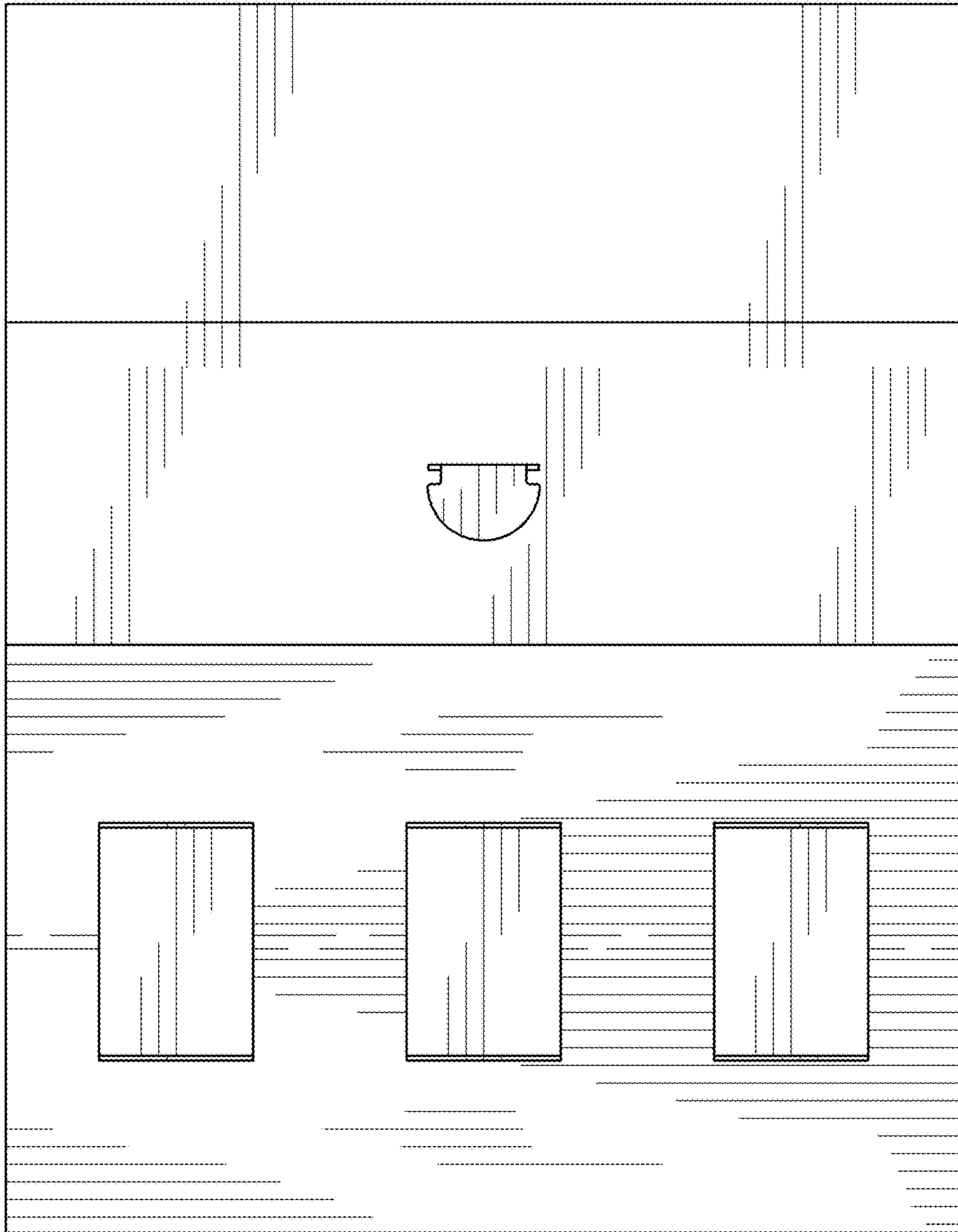

FIG. 5

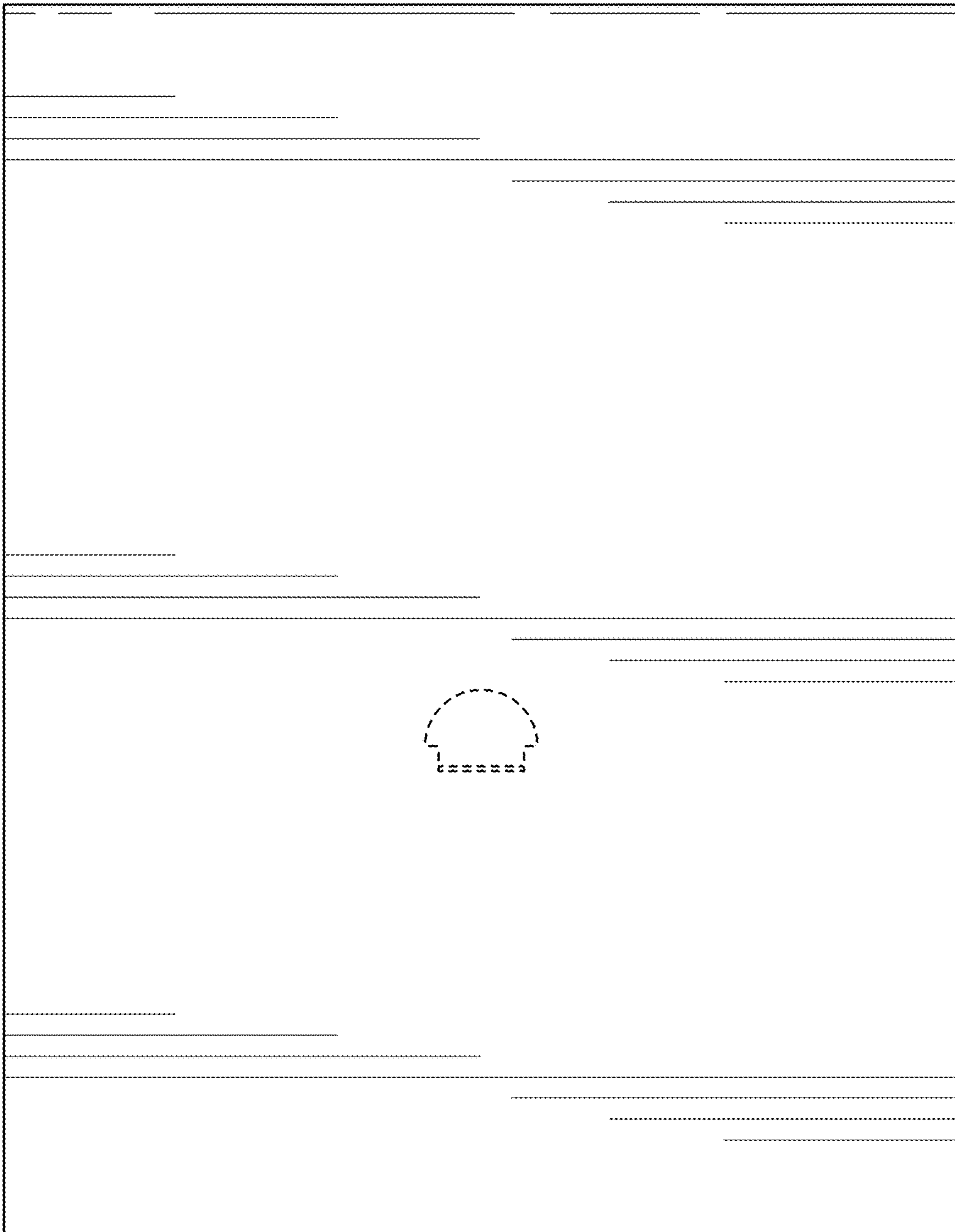

FIG. 6

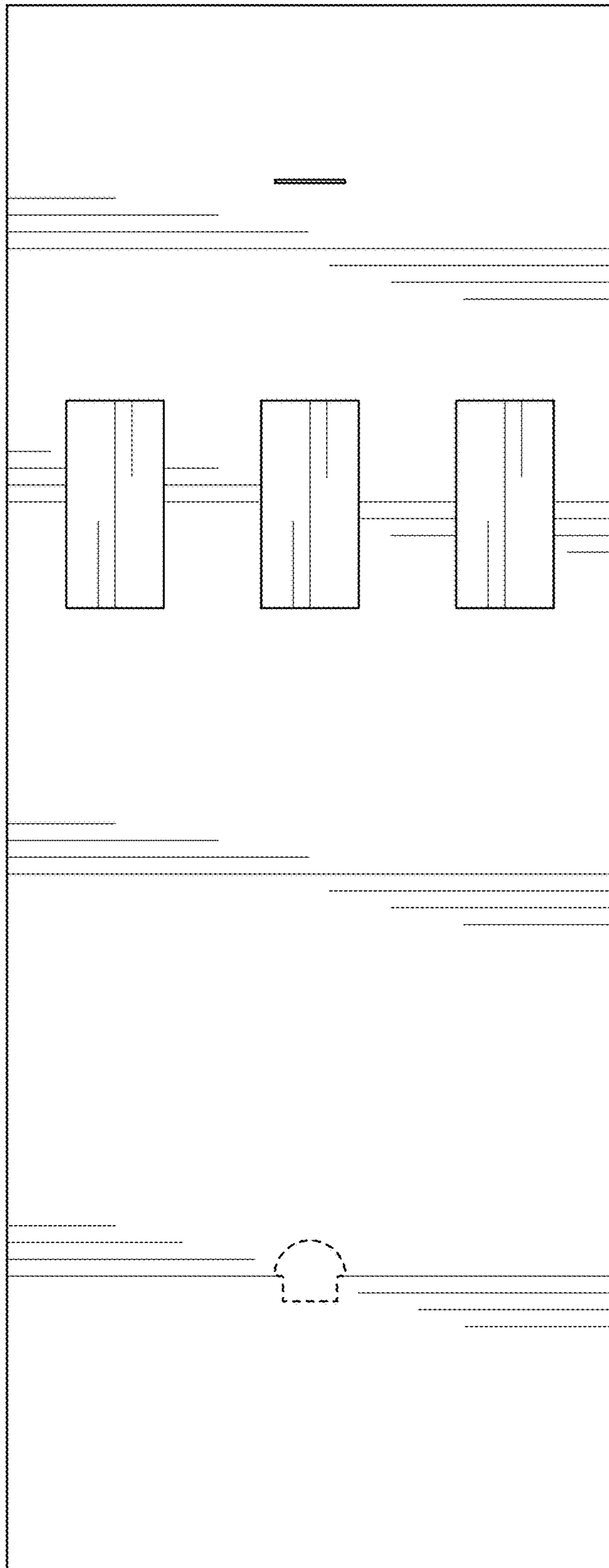

FIG. 7