



US00D817708S

(12) **United States Design Patent**
Kim et al.

(10) **Patent No.:** **US D817,708 S**
(45) **Date of Patent:** **** May 15, 2018**

(54) **BURNER FOR GAS RANGE**

F24C 7/067; F24C 7/062; F24C 7/082;
F24C 7/081; A47J 37/0709

See application file for complete search history.

(71) Applicant: **LG ELECTRONICS INC.**, Seoul
(KR)

(56) **References Cited**

(72) Inventors: **Sooyeon Kim**, Seoul (KR); **Hanjin Jung**, Seoul (KR); **Miyoung Kim**, Seoul (KR); **Songyi Han**, Seoul (KR); **Inhwan Ryu**, Seoul (KR)

U.S. PATENT DOCUMENTS

(73) Assignee: **LG Electronics Inc.**, Seoul (KR)

(**) Term: **15 Years**

(21) Appl. No.: **35/502,014**

(22) Filed: **May 30, 2016**

(80) **Hague Agreement Data**

Int. Filing Date: **May 30, 2016**

Int. Reg. No.: **DM/092245**

Int. Reg. Date: **May 30, 2016**

Int. Reg. Pub. Date: **Dec. 2, 2016**

5,002,038	A *	3/1991	Riehl	F23D 14/06 126/39 H
5,040,970	A *	8/1991	Riehl	F23D 14/06 126/39 E
5,083,915	A *	1/1992	Riehl	F24C 3/103 126/39 E
5,085,202	A *	2/1992	Riehl	F24C 3/085 126/39 R
5,112,218	A *	5/1992	Sigler	F24C 3/103 126/39 E
5,133,334	A *	7/1992	Riehl	F23D 14/06 126/39 R
5,139,417	A *	8/1992	Ghassemzadeh	F23D 14/06 126/39 H
5,149,262	A *	9/1992	Riehl	F23D 14/06 126/39 H
5,152,276	A *	10/1992	Brock	F24C 3/103 126/39 E
5,160,255	A *	11/1992	Sigler	F23Q 3/006 126/39 E

(Continued)

Primary Examiner — Richard E Chilcot

(74) *Attorney, Agent, or Firm* — Birch, Stewart, Kolasch & Birch, LLP

(30) **Foreign Application Priority Data**

Nov. 30, 2015 (KR) 30-2015-0060404

(51) **LOC (11) Cl.** **07-02**

(52) **U.S. Cl.**

USPC **D7/407**

CPC **F24C 15/107** (2013.01)

(58) **Field of Classification Search**

USPC D7/339–347, 362–397, 402–409

CPC F24C 15/107; F24C 15/12; F24C 15/36;

F24C 3/08; F24C 3/082; F24C 3/085;

(57) **CLAIM**

The ornamental design for a burner for gas range, as shown and described.

DESCRIPTION

1. Burner for gas range

1.1 is a perspective view of a burner for gas range showing our new design;

1.2 is a front elevation view thereof;

1.3 is a rear elevation view thereof;

1.4 is a left-side elevation view thereof;

1.5 is a right-side elevation view thereof;

(Continued)

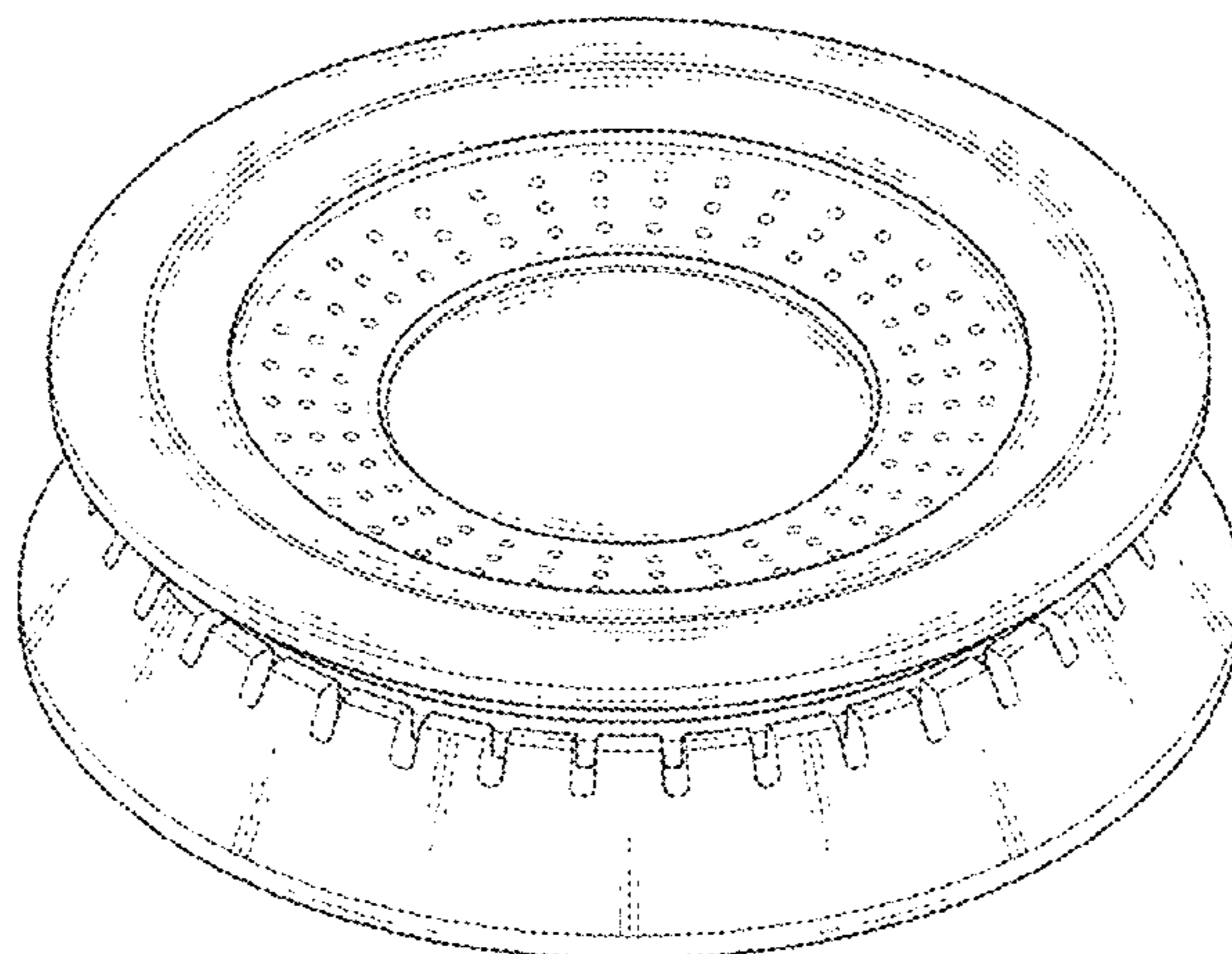

1.6 is a top plan view thereof;
 1.7 is a bottom plan view thereof; and
 1.8 is another perspective view thereof, in a use condition.
 The broken lines in the drawing figures are included for the purpose of illustrating environment and form no part of the claimed design.

1 Claim, 8 Drawing Sheets

(56)

References Cited

U.S. PATENT DOCUMENTS

5,160,256 A * 11/1992 Riehl F24C 3/103
 126/39 BA
 5,397,234 A * 3/1995 Kwiatek F24C 3/103
 126/39 E
 D369,517 S * 5/1996 Ferlin D7/407
 7,017,572 B2 * 3/2006 Cadima F23D 14/06
 126/39 E

D524,105 S * 7/2006 Poltronieri D7/407
 D564,296 S * 3/2008 Koch D7/407
 D581,214 S * 11/2008 Rosa D7/407
 D581,736 S * 12/2008 Besseas D7/407
 D584,567 S * 1/2009 Hughes D7/407
 D610,870 S * 3/2010 Westers D7/407
 7,841,332 B2 * 11/2010 Pottenger F23D 14/06
 126/39 E
 D642,675 S * 8/2011 Scribano D23/415
 D678,722 S * 3/2013 Lona Santoyo D7/407
 D682,028 S * 5/2013 Preisler D7/407
 D685,225 S * 7/2013 Santoyo D7/407
 D687,675 S * 8/2013 Filho D7/407
 D697,369 S * 1/2014 Lona Santoyo D7/407
 D704,508 S * 5/2014 Nordwall D7/346
 D743,203 S * 11/2015 Filho D7/407
 D745,321 S * 12/2015 Koch D7/407
 D758,129 S * 6/2016 Filho D7/407
 D766,036 S * 9/2016 Koch D7/407
 D772,647 S * 11/2016 Zambruni D7/407
 D775,888 S * 1/2017 Kim D7/337
 D787,041 S * 5/2017 Lah D23/415

* cited by examiner

1.1

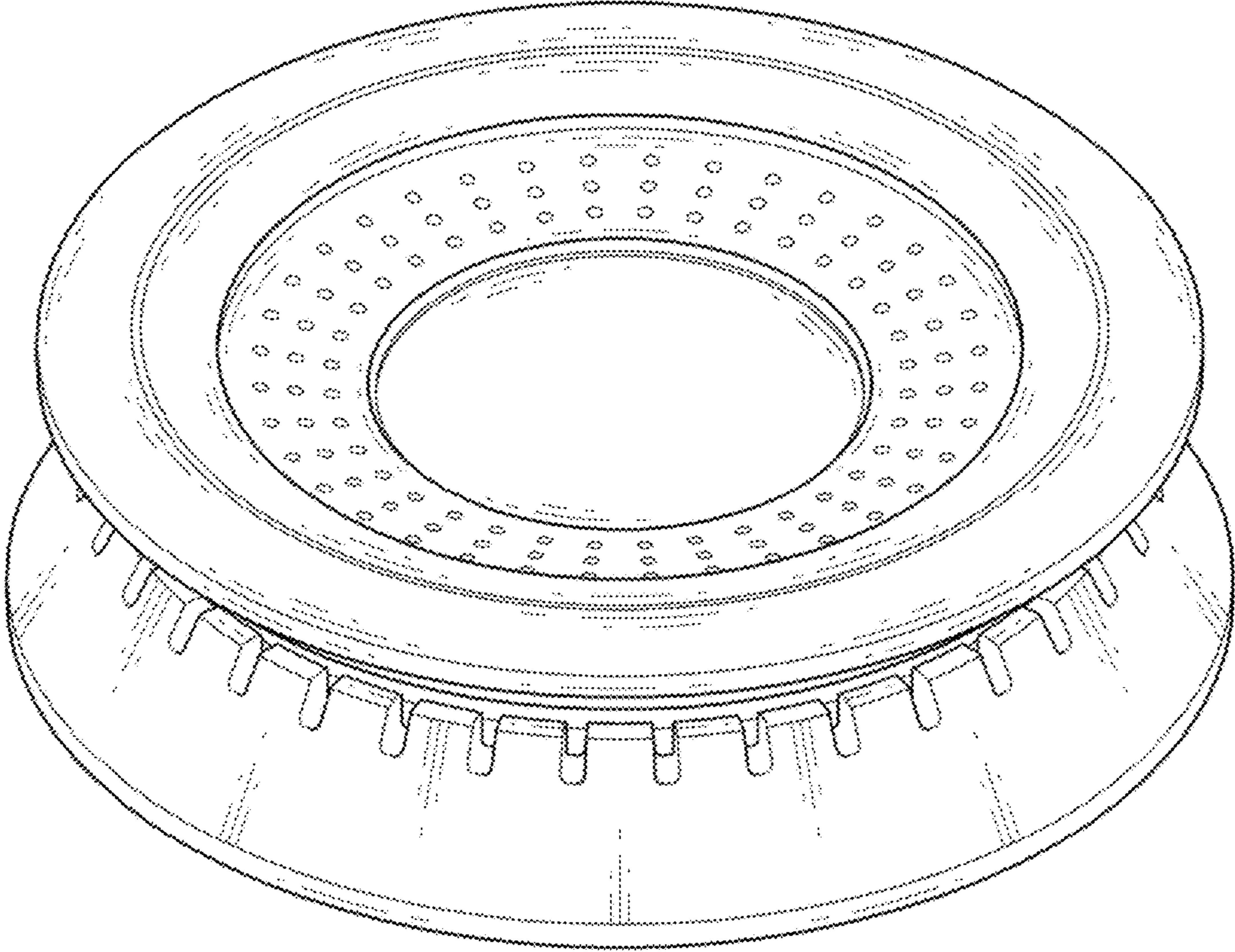

1.2

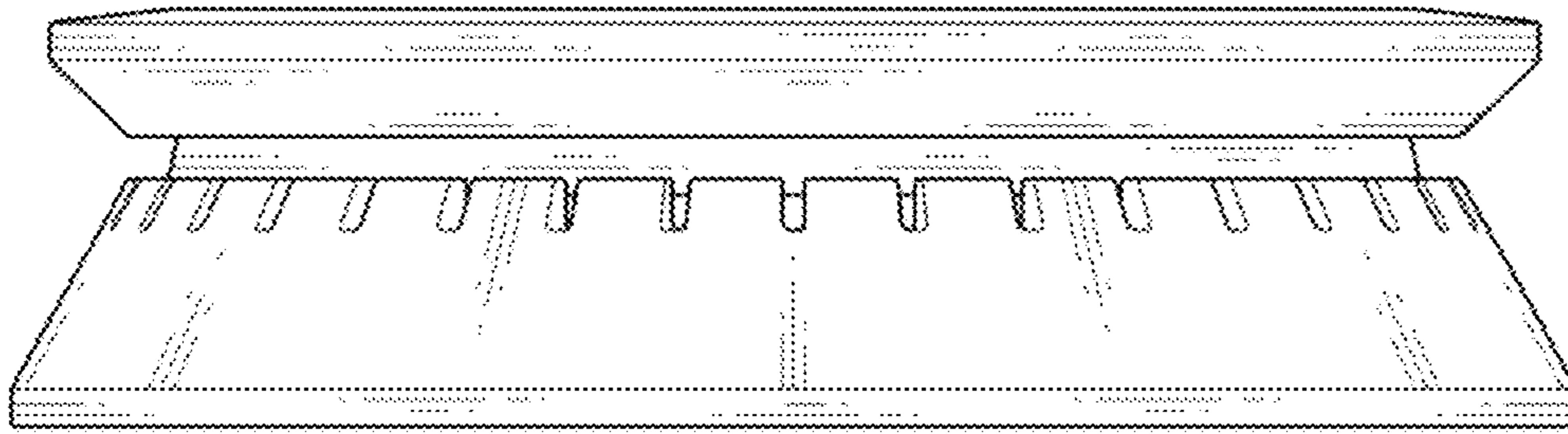

1.3

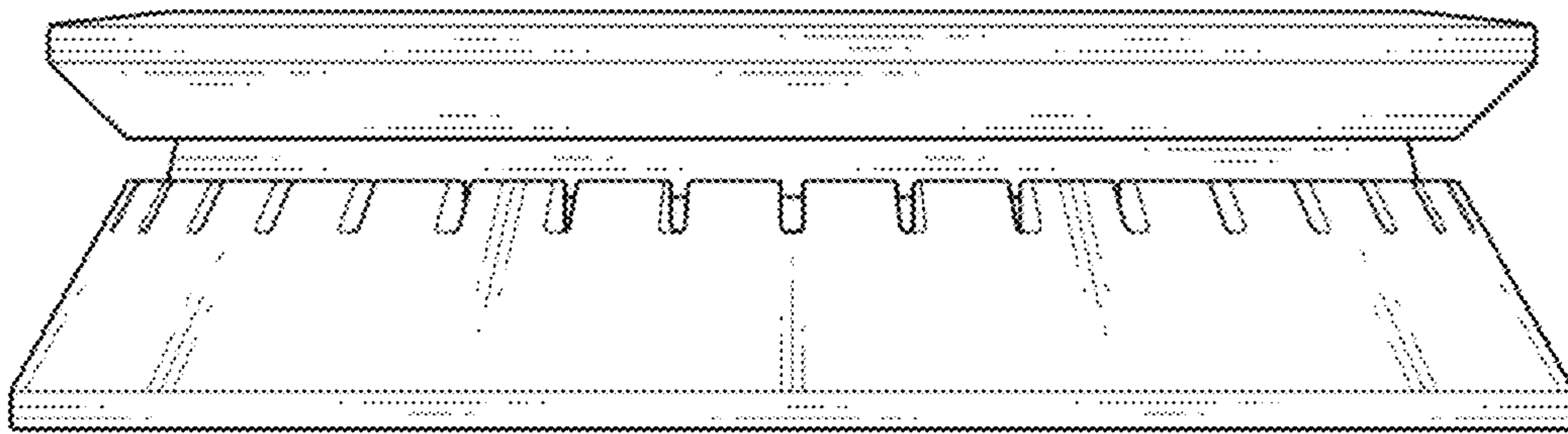

1.4

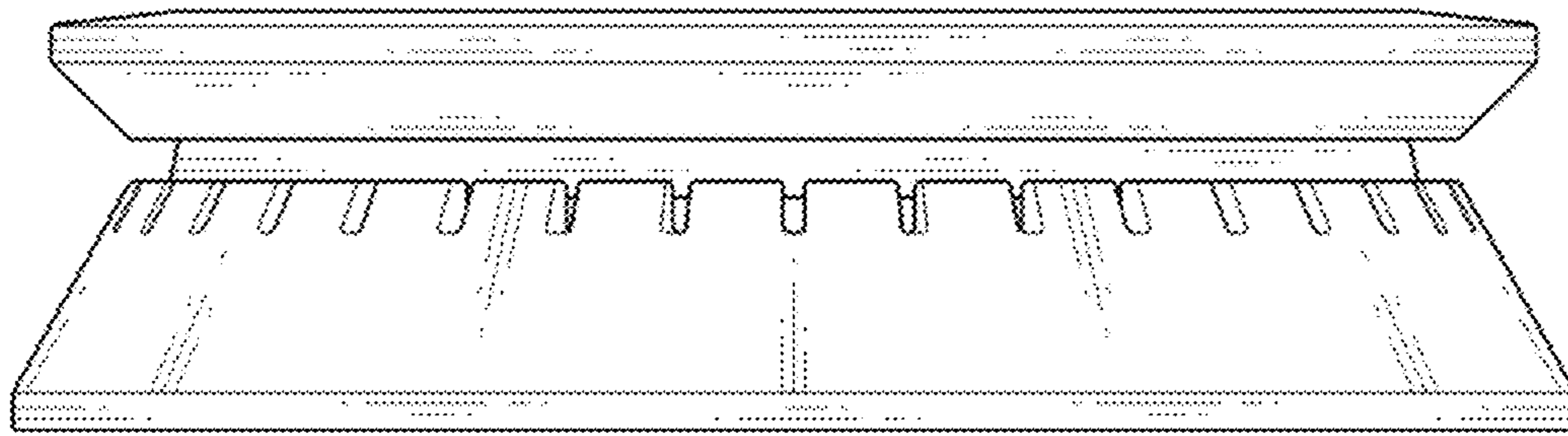

1.5

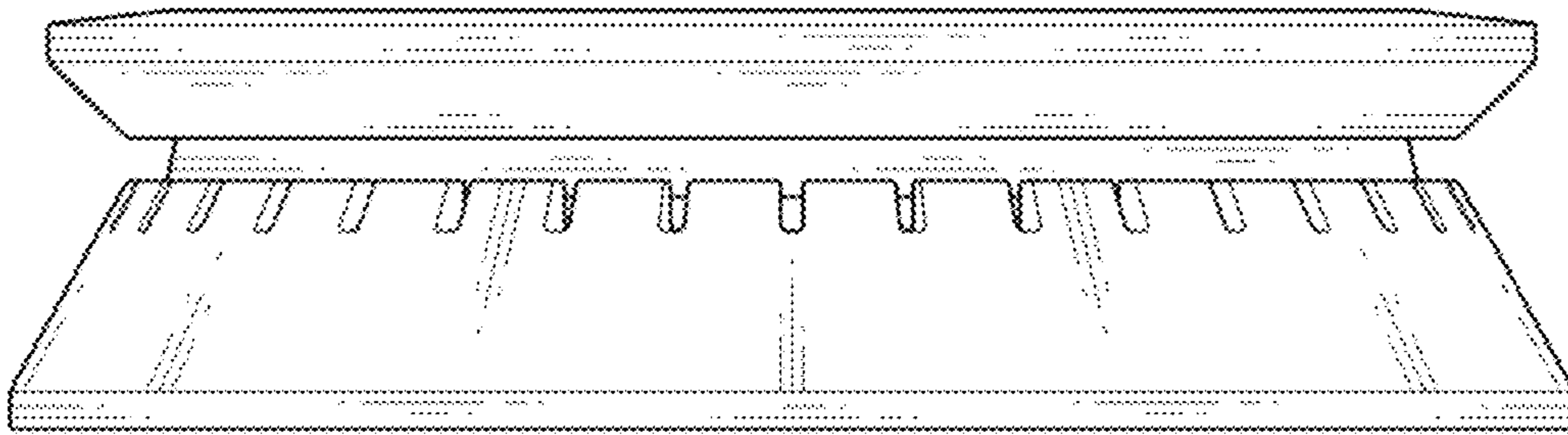

1.6

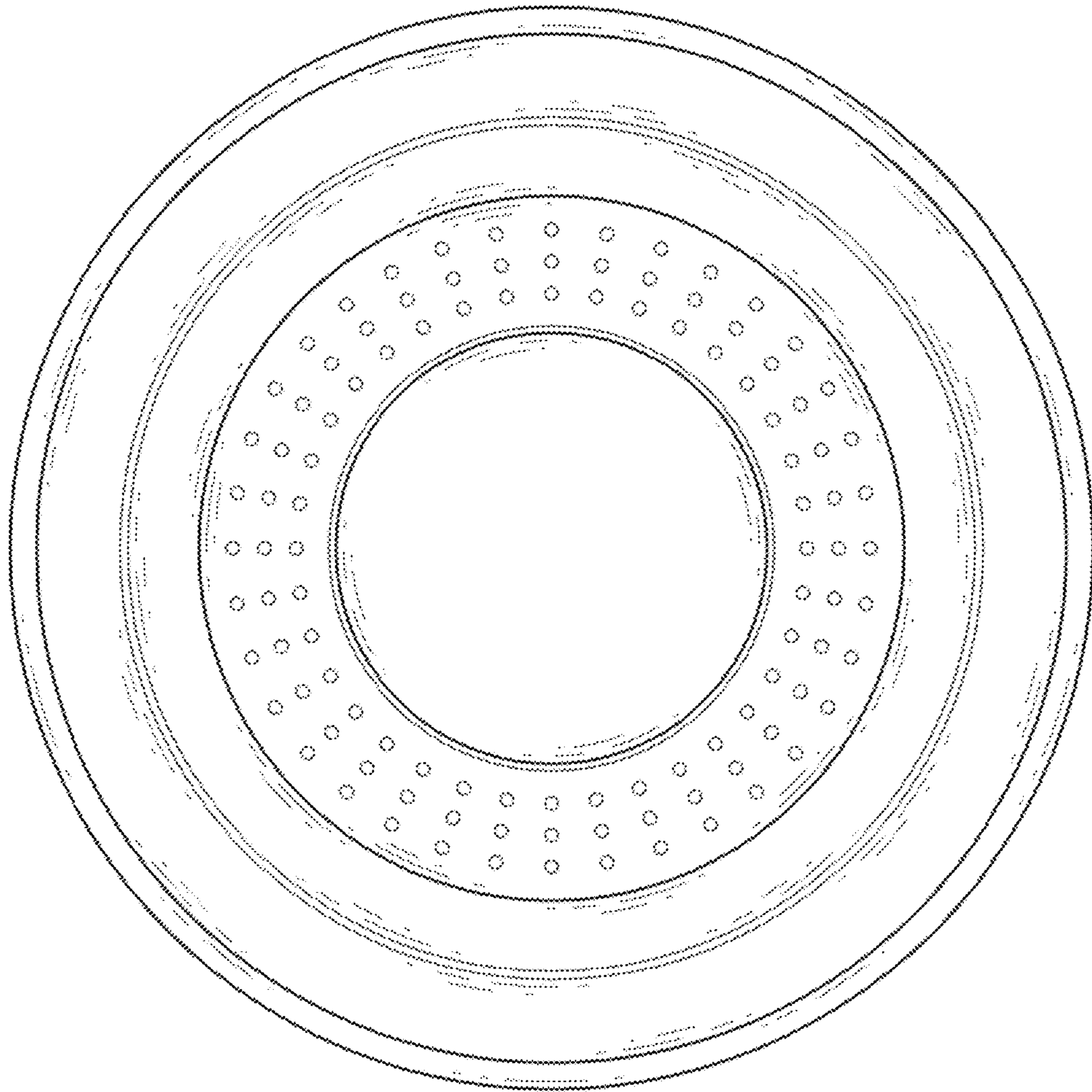

1.7

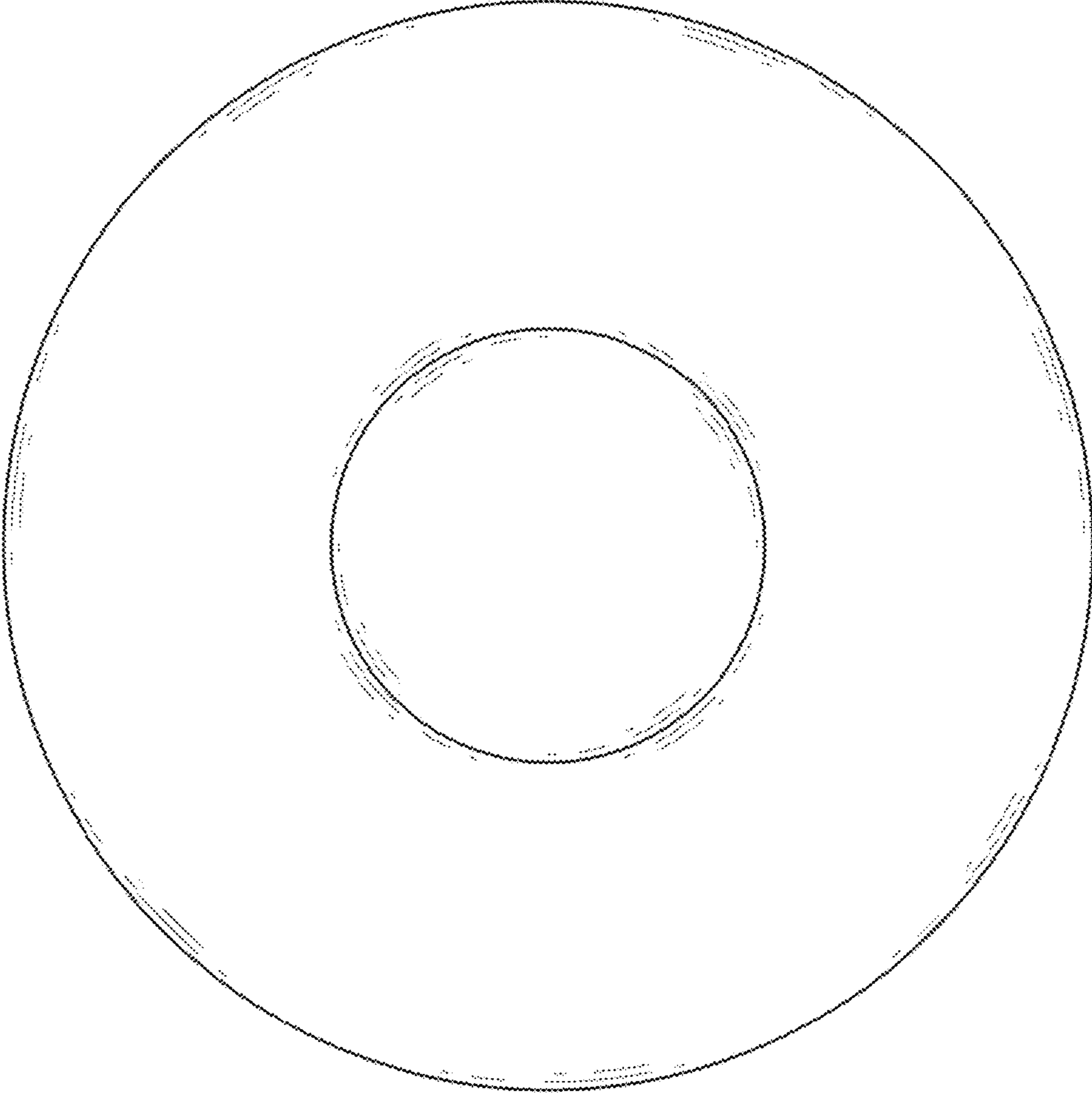

1.8

