



US00D817669S

(12) **United States Design Patent** (10) **Patent No.:** **US D817,669 S**
Burden (45) **Date of Patent:** **** May 15, 2018**

(54) **TABLE**

(71) Applicant: **Ian James Burden**, Sovereign Islands (AU)

(72) Inventor: **Ian James Burden**, Sovereign Islands (AU)

(**) Term: **15 Years**

(21) Appl. No.: **29/585,842**

(22) Filed: **Nov. 29, 2016**

(30) **Foreign Application Priority Data**

Sep. 14, 2016 (AU) 201615215

(51) **LOC (11) Cl.** **06-04**

(52) **U.S. Cl.**
USPC **D6/671**

(58) **Field of Classification Search**

USPC D6/334–336, 349, 351, 352, 358, 360, D6/364, 365, 366, 374, 375, 379, 380, D6/657, 662.1, 672, 674, 675, 675.1, D6/675.3, 683, 683.1, 685, 691, 691.5, D6/702, 708, 708.2, 708.21, 708.25, 716, D6/716.1–716.4; D3/304, 307, 309; D7/550.1, 554.3

CPC A47B 7/00; A47B 2200/001; A47B 2200/002; A47B 2200/0011; A47B 2200/0014; A47B 2200/0021; A47B 2200/0023; A47B 2200/0026; A47B 2200/0027; A47B 2200/0039; A47B 13/00; A47B 13/02; A47B 13/021; A47B 13/028; A47B 2009/006; A47B 57/402; A47B 67/00; A47B 87/0207; A47B 96/00; A47B 96/02; A47B 43/00; A47B 63/00; A47C 1/04; A47C 1/03255; A47C 1/0255; A47C 3/00; A47C 3/18; A47C 3/026; A47C 4/02; A47C 4/028; A47C 4/54; A47C 7/00; A47C 7/002; A47C 7/004; A47C 7/006; A47C 7/18; A47C 7/022; A47C 7/24; A47C 7/50; A47C 9/002; A47C 9/007; A47D 7/00; A47F

1/00; A47F 3/00; A47F 3/06; A47F 3/14; A47F 7/00; B65D 1/34; B65D 81/3813; B65D 21/00; B65D 5/545; B65D 5/26; B65D 5/0015; B65D 5/0045

See application file for complete search history.

(56) **References Cited**

U.S. PATENT DOCUMENTS

D239,684 S * 4/1976 Robertson D6/691.1
D281,555 S * 12/1985 Levy D6/406.6
D303,877 S * 10/1989 Norton D6/349

(Continued)

OTHER PUBLICATIONS

“Reclaimed Barn Wood Coffee Table with Metal Legs—Handcrafted” Mar. 8, 2015, ebay.com, site visited Feb. 23, 2018 <<https://www.ebay.com/itm/Reclaimed-Barn-Wood-Coffee-Table-with-Metal-Legs-Handcrafted-/301629657717>> (Year: 2015).*

Primary Examiner — Kevin K Rudzinski

Assistant Examiner — Paul D Bohannon

(74) *Attorney, Agent, or Firm* — Dykema Gossett PLLC

(57) **CLAIM**

The ornamental design for a table, as shown and described.

DESCRIPTION

FIG. 1 is an elevational first side view of a table showing my new and ornamental design, the opposite side view being a mirror image,

FIG. 2 is an elevational first end view thereof, the opposite end view being a mirror image,

FIG. 3 is a top plan view thereof,

FIG. 4 is a bottom plan view thereof,

FIG. 5 is a perspective side view thereof; and,

FIG. 6 is a perspective opposite side view thereof.

The broken lines in FIGS. 1, 2 and 4 represent features of the table which form no part of the claimed.

1 Claim, 6 Drawing Sheets

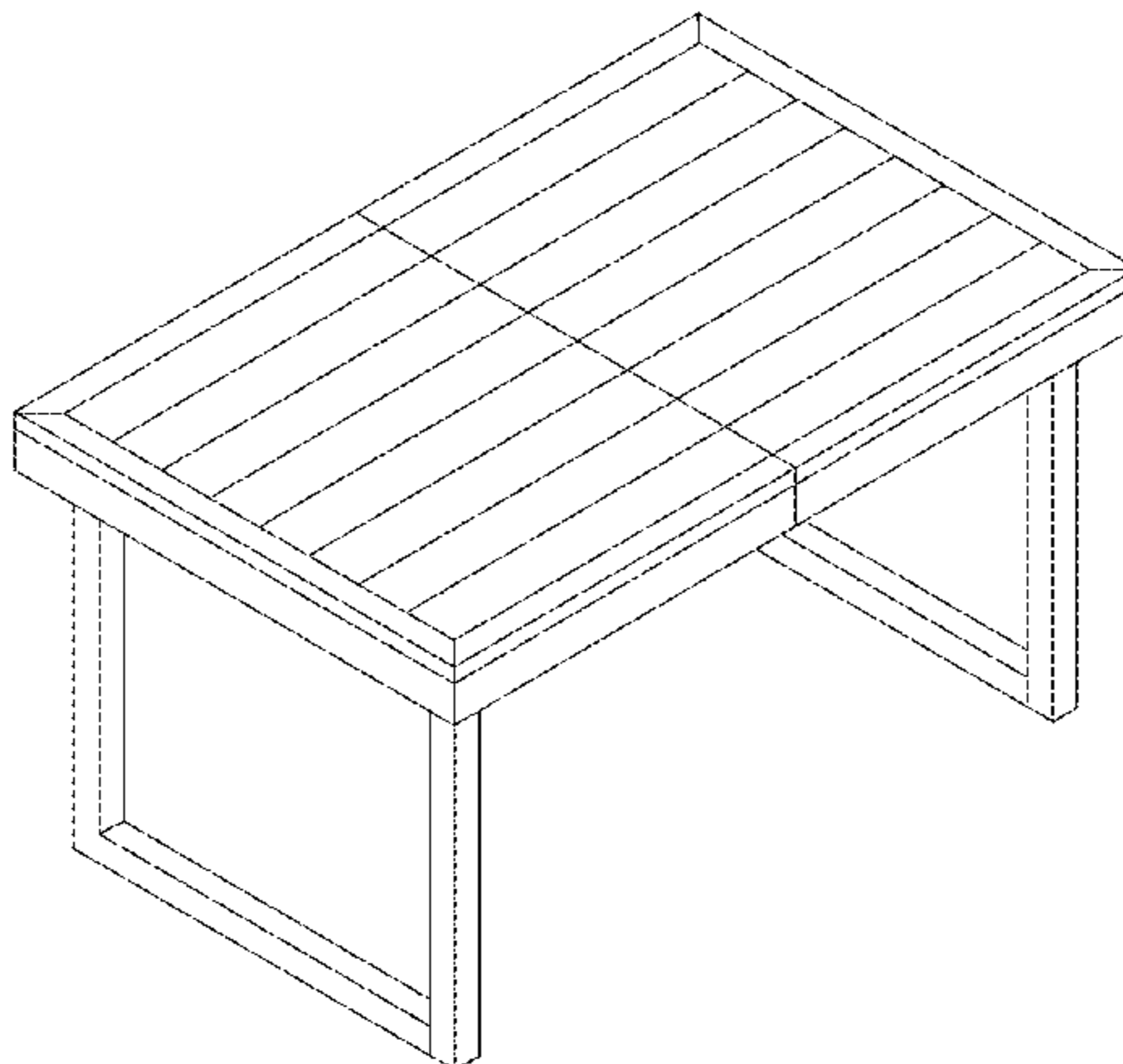

(56)

References Cited

U.S. PATENT DOCUMENTS

D442,391	S *	5/2001	Wu	D6/691.1
D588,380	S *	3/2009	Bucholz	D6/691.5
D608,568	S *	1/2010	Manz	D6/691.5
D614,889	S *	5/2010	Van Duysen	D6/691.5
D637,836	S *	5/2011	Cortivo	D6/656
D703,465	S *	4/2014	Weatherly	D6/656.16
D728,980	S *	5/2015	Asner	D6/691.1
D734,078	S *	7/2015	Bougay	D6/691.1
D734,630	S *	7/2015	Bolton	D6/691.1
D753,419	S *	4/2016	Heirakuji	D6/675
D794,364	S *	8/2017	Tsuchiyama	D6/708
2007/0040483	A1 *	2/2007	Arkay-Leliever	A47B 21/06 312/194
2009/0095204	A1 *	4/2009	Levy	A47B 7/02 108/17
2015/0320203	A1 *	11/2015	Mandon	A47B 21/06 108/20

* cited by examiner

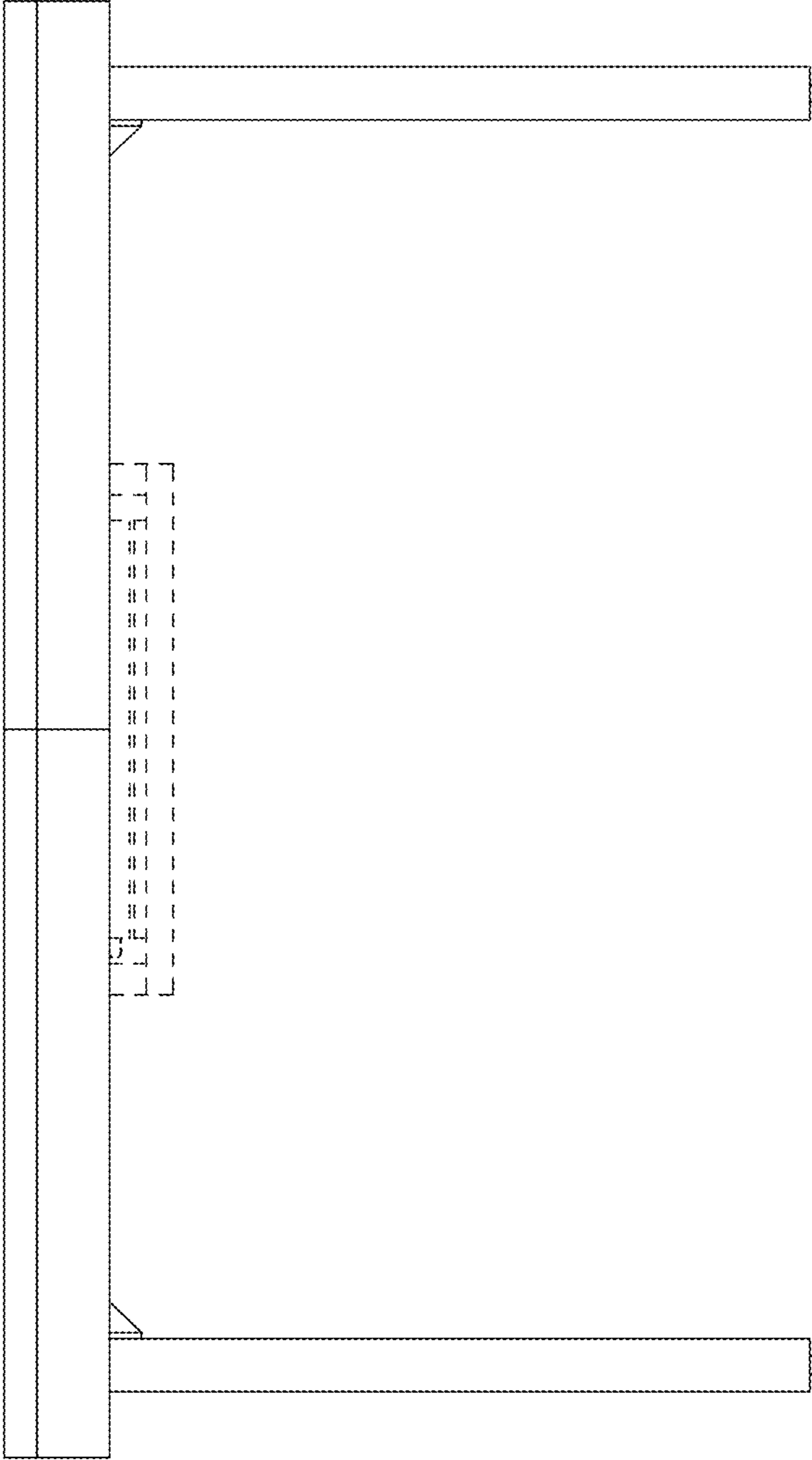

FIG. 1

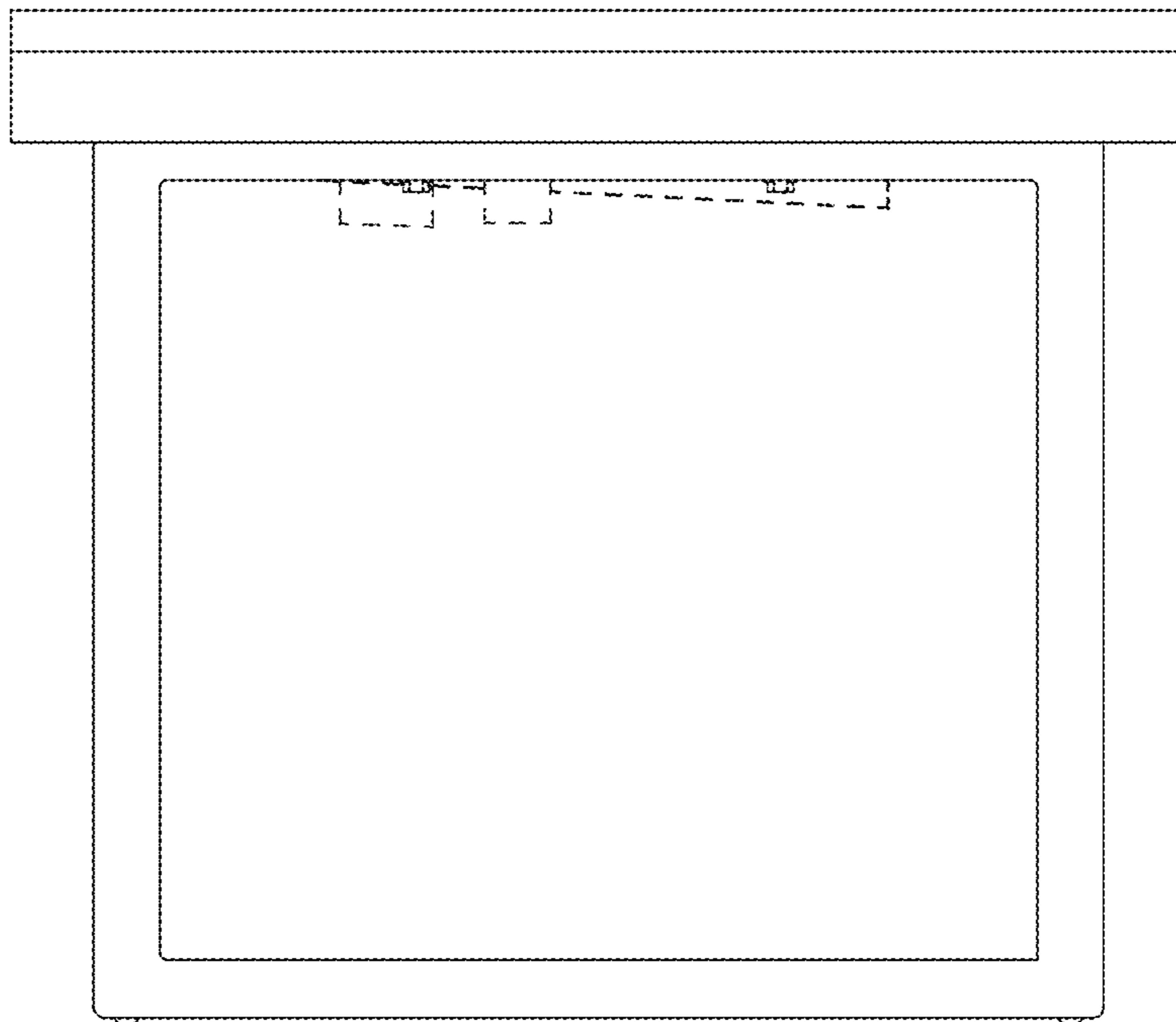

FIG. 2

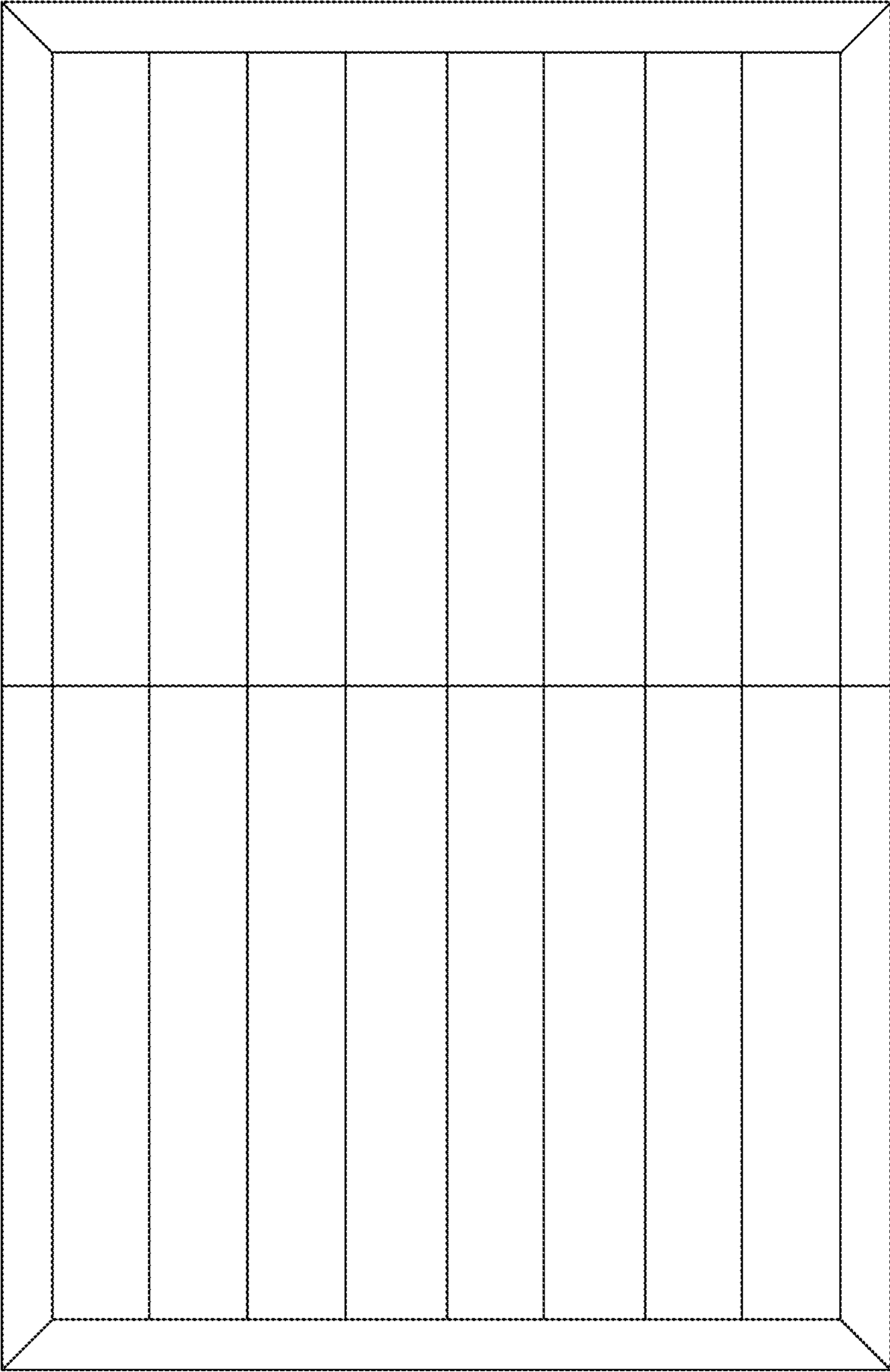

FIG. 3

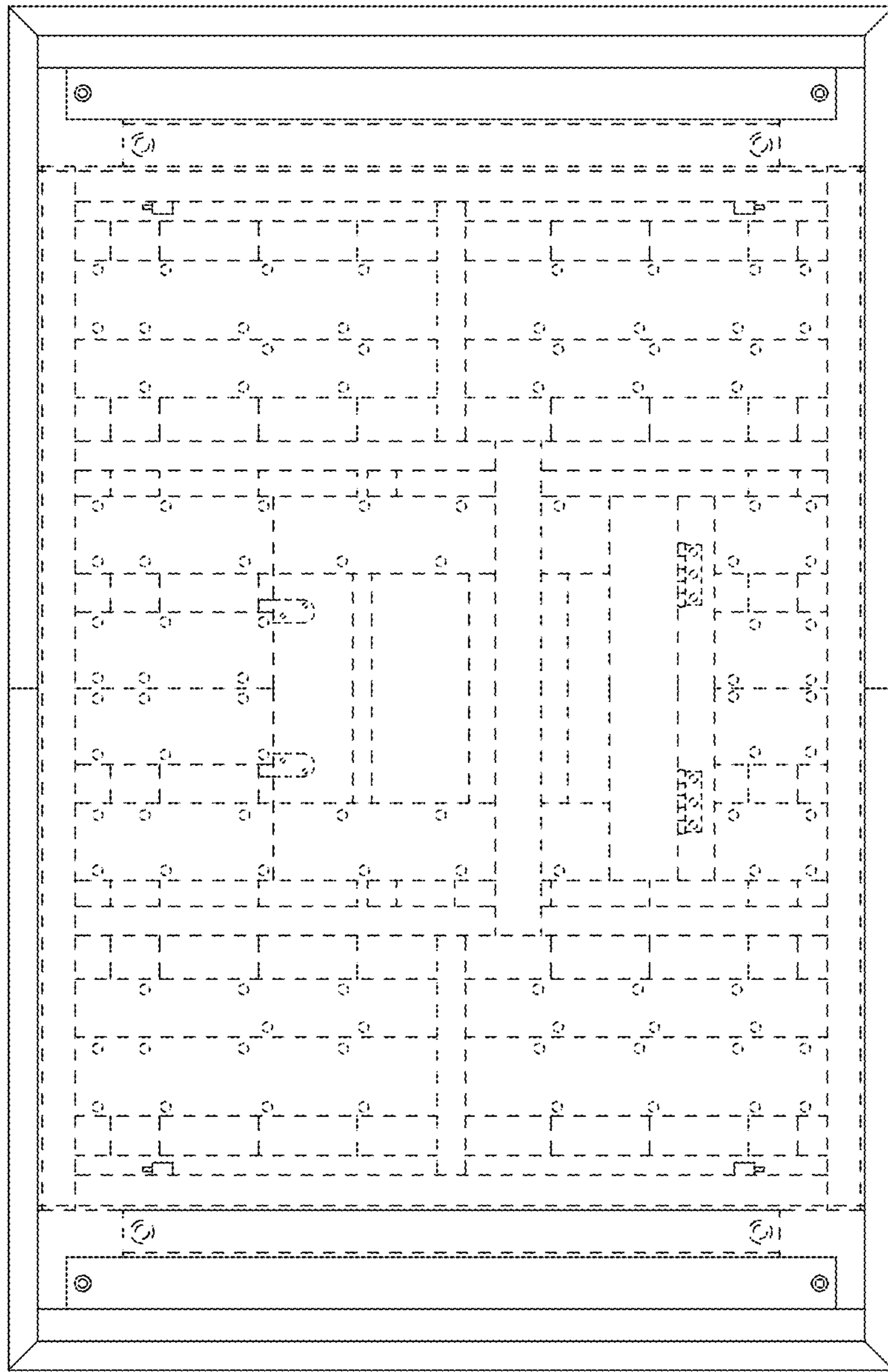

FIG. 4

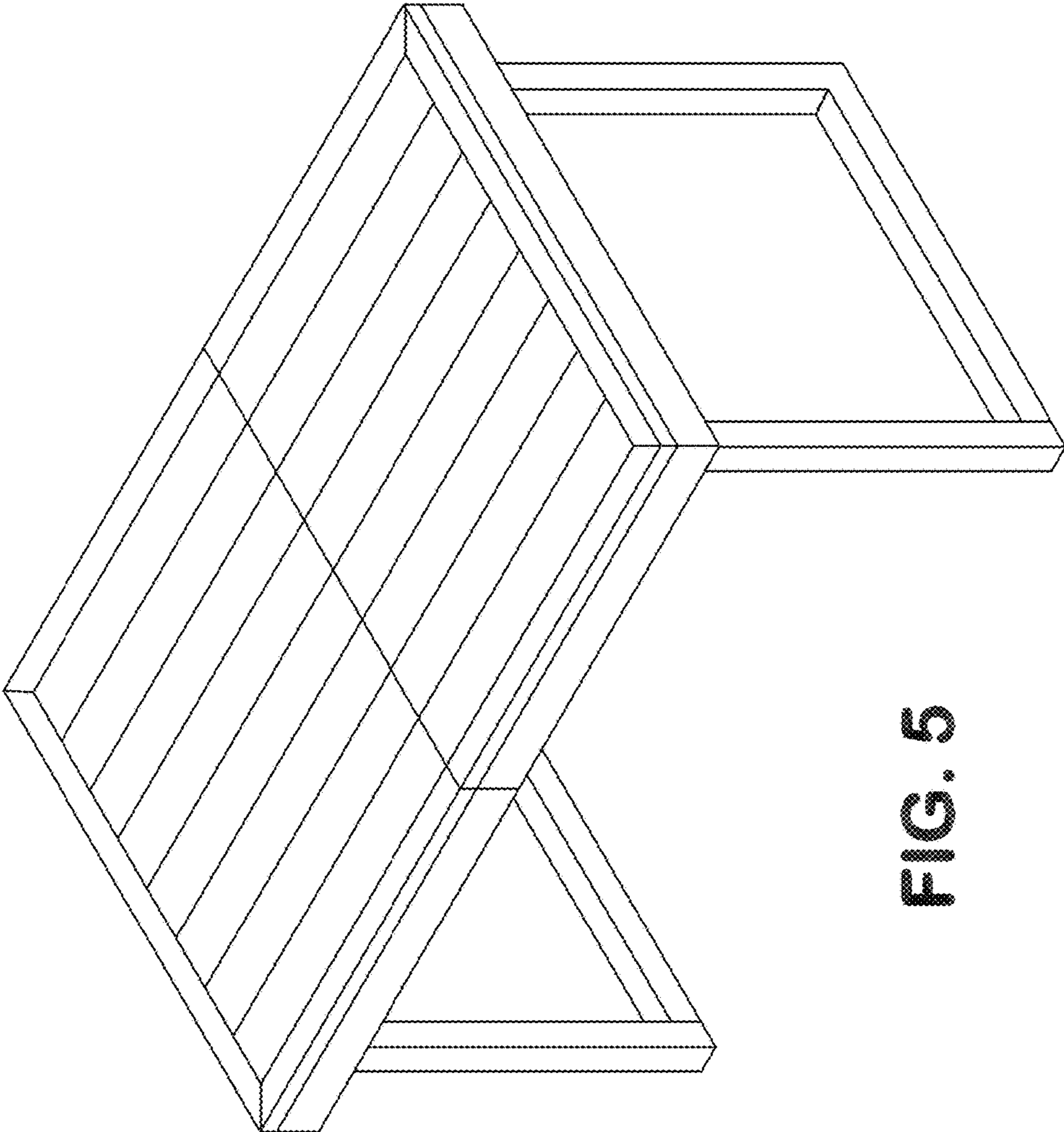

FIG. 5

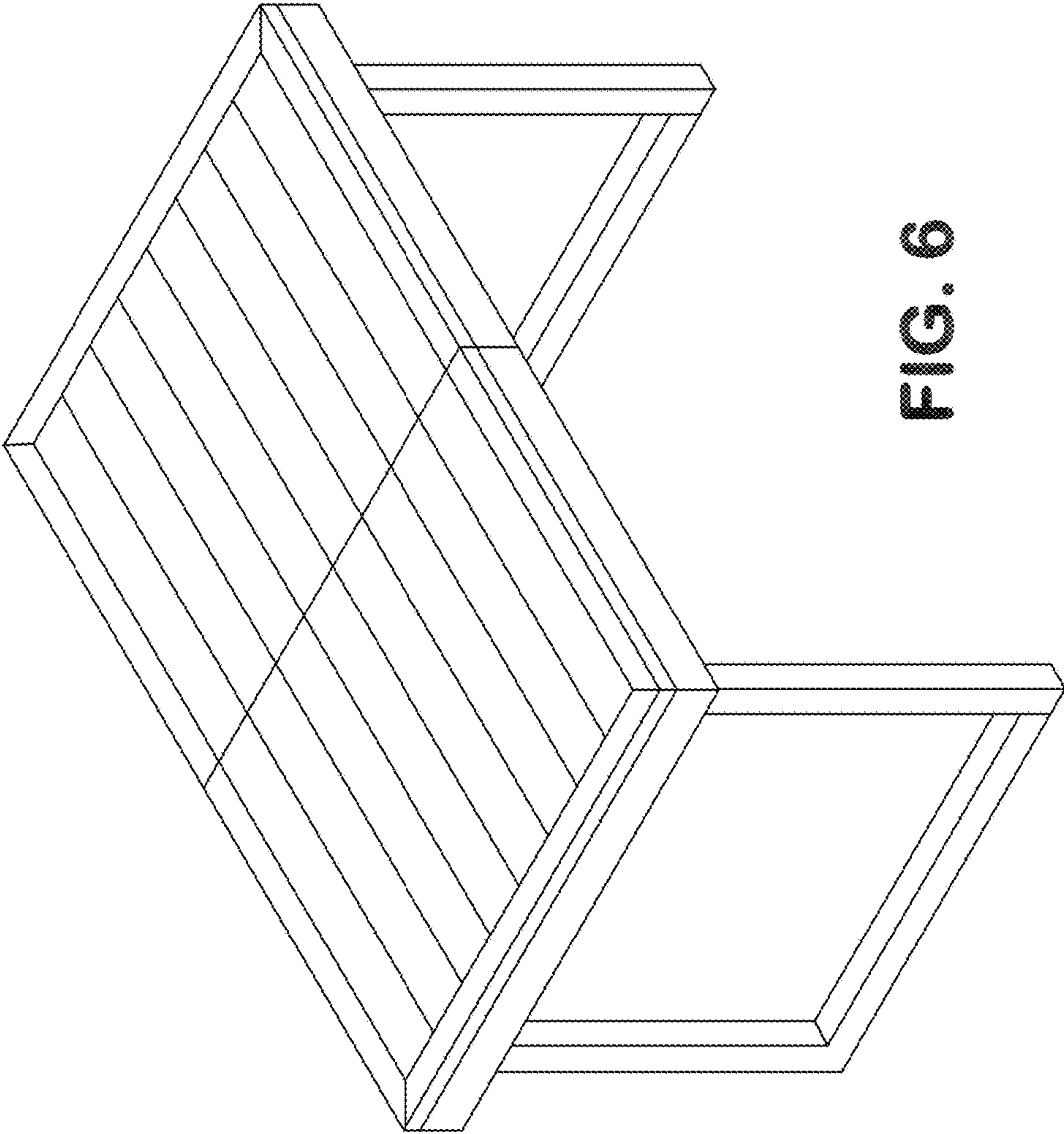

FIG. 6

UNITED STATES PATENT AND TRADEMARK OFFICE
CERTIFICATE OF CORRECTION

PATENT NO. : D817,669 S
APPLICATION NO. : 29/585842
DATED : May 15, 2018
INVENTOR(S) : Burden

Page 1 of 1

It is certified that error appears in the above-identified patent and that said Letters Patent is hereby corrected as shown below:

In the description, Lines 10 and 11 should read:

--The broken lines in FIGS. 1, 2, and 4 represent features of the table which form no part of the claimed design.--

Signed and Sealed this
Twenty-sixth Day of June, 2018

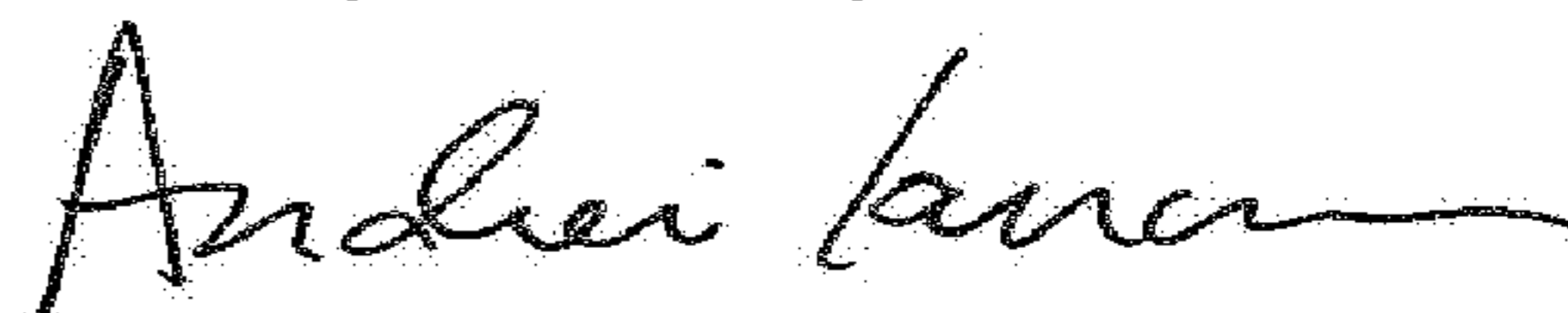

Andrei Iancu
Director of the United States Patent and Trademark Office