



US00D817642S

(12) **United States Design Patent** (10) **Patent No.:** **US D817,642 S**  
**Amat** (45) **Date of Patent:** **\*\* May 15, 2018**

(54) **HANDBAG WITH APPLIED METAL BOW**

D734,742 S \* 7/2015 Fujioka ..... D14/217  
D741,067 S \* 10/2015 Votel ..... D3/327  
D765,413 S \* 9/2016 Derr ..... D3/327

(71) Applicant: **J. Choo Limited**, London (GB)

\* cited by examiner

(72) Inventor: **Lina Amat**, London (GB)

*Primary Examiner* — Holly H Baynham

(73) Assignee: **J. Choo Limited**, London (GB)

(74) *Attorney, Agent, or Firm* — Fross Zelnick Lehrman & Zissu, P.C.; Lawrence E. Apolzon, Esq.

(\*\*) Term: **15 Years**

(57) **CLAIM**

(21) Appl. No.: **29/581,518**

The ornamental design for a handbag with applied metal bow, as shown and described.

(22) Filed: **Oct. 19, 2016**

**DESCRIPTION**

(30) **Foreign Application Priority Data**

Apr. 20, 2016 (EM) ..... 003076611-0009

(51) **LOC (11) Cl.** ..... **03-01**

(52) **U.S. Cl.**  
USPC ..... **D3/318**

(58) **Field of Classification Search**  
USPC ..... D3/232–233, 240–243, 245–246, 318  
CPC ... A45C 1/024; A45C 3/06; A45F 3/14; A45F  
5/10

See application file for complete search history.

FIG. 1 is a front perspective view of a portion of a handbag showing my new design;  
FIG. 2 is a right side view thereof;  
FIG. 3 is a left side view thereof;  
FIG. 4 is a front view thereof;  
FIG. 5 is a rear view thereof;  
FIG. 6 is a top view thereof;  
FIG. 7 is a bottom view thereof;  
FIG. 8 is a front perspective view of an alternative embodiment of the portion of a handbag shown in FIG. 1, shown in the environment of a handbag;  
FIG. 9 is a right side view thereof;  
FIG. 10 is a left side view thereof;  
FIG. 11 is a front view thereof;  
FIG. 12 is a back view thereof;  
FIG. 13 is a top view thereof; and,  
FIG. 14 is a bottom view thereof.

(56) **References Cited**

**U.S. PATENT DOCUMENTS**

D136,747 S 11/1943 Murphy  
D141,474 S 6/1945 Rath  
5,110,023 A \* 5/1992 Colin ..... A45F 3/14  
224/250  
D408,116 S \* 4/1999 Gale ..... D2/624  
D467,520 S 12/2002 Petros  
D620,252 S \* 7/2010 Keels ..... D3/247  
D703,579 S 4/2014 Kuster et al.

The broken lines showing the portion of the bow and a handbag are for the purposes of illustrating environment and forms no part of the claimed design.

**1 Claim, 10 Drawing Sheets**

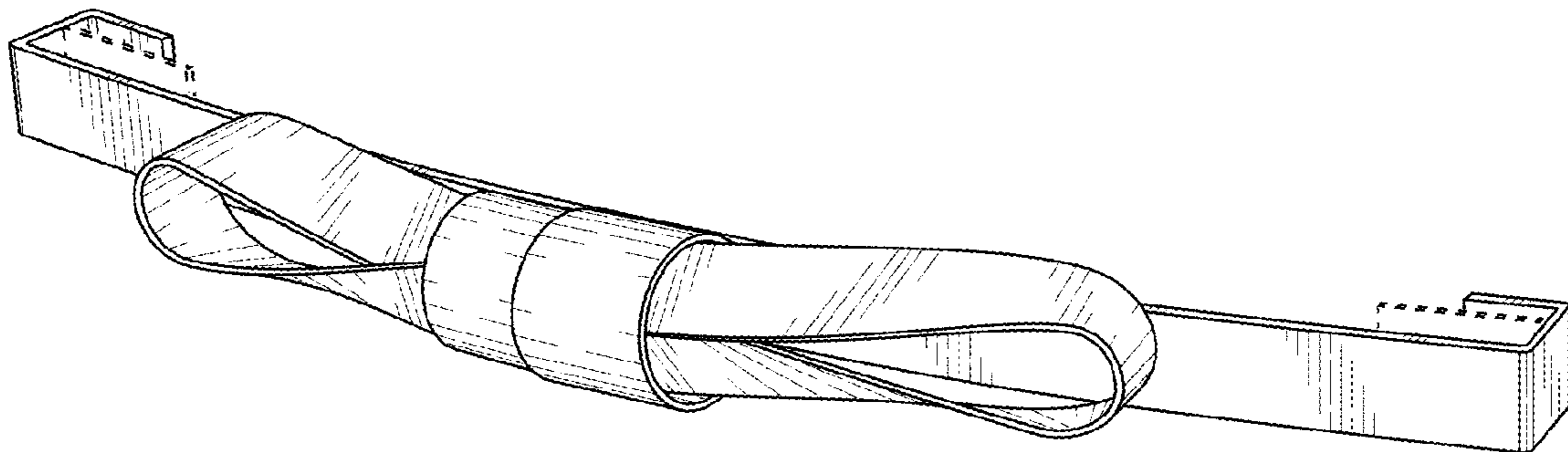

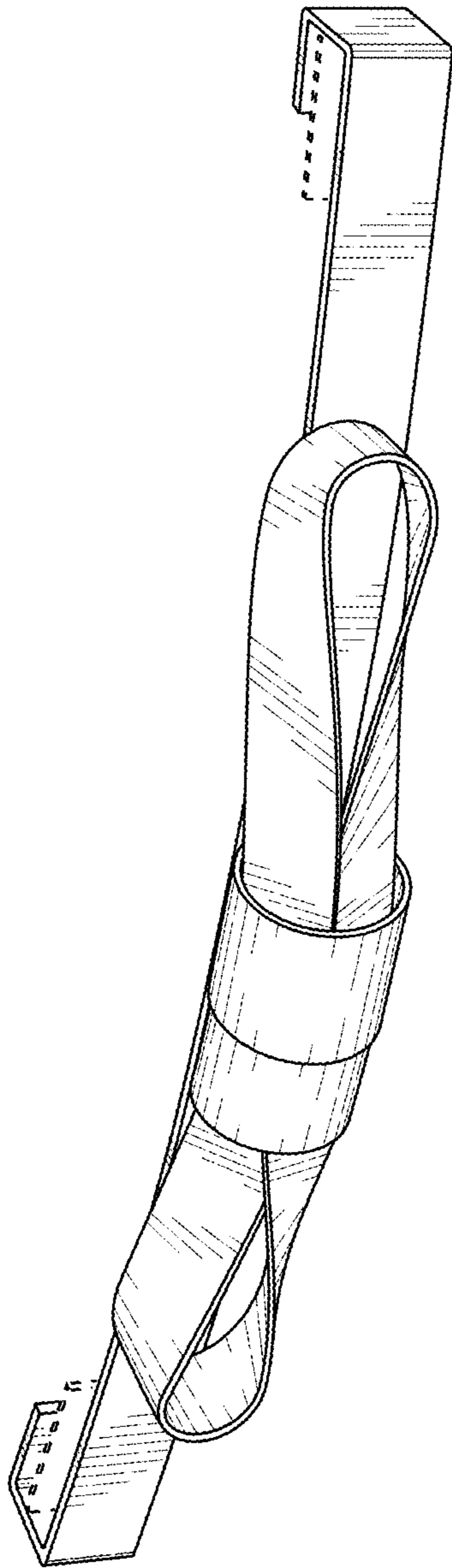

FIG. 1

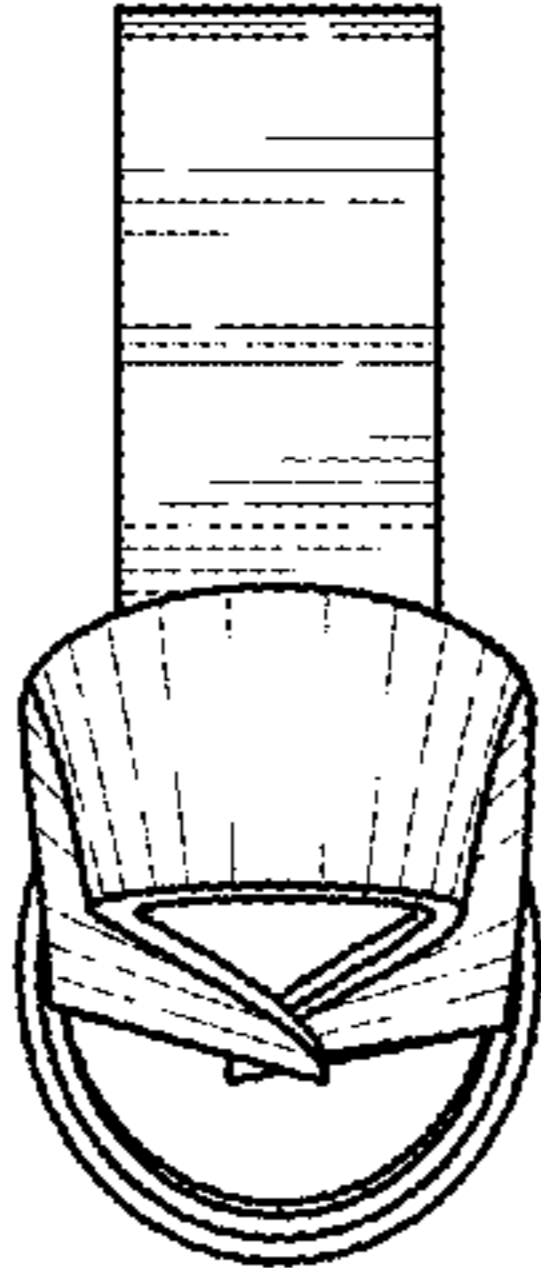

FIG. 2

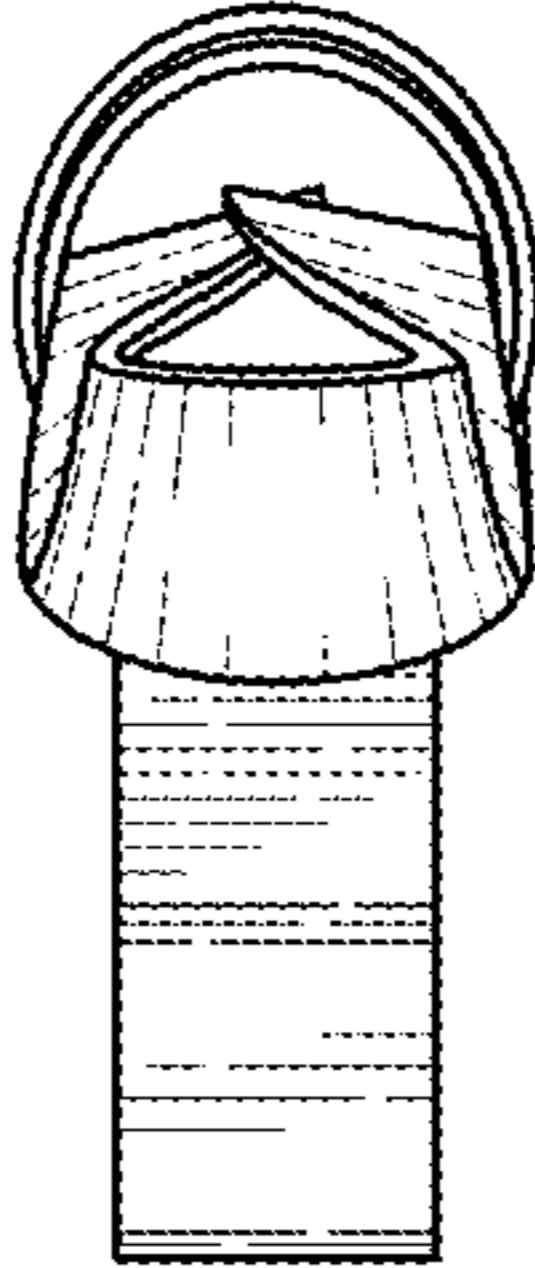

FIG. 3

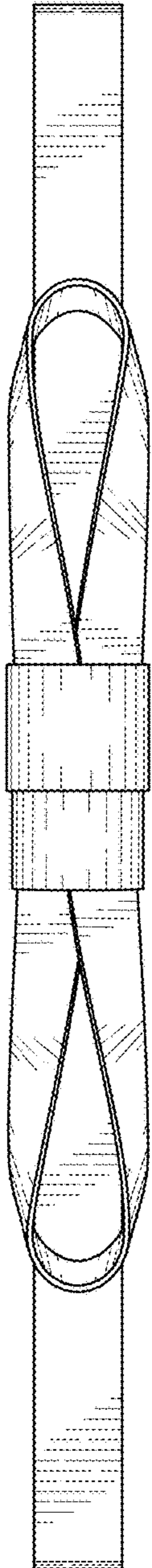

FIG. 4

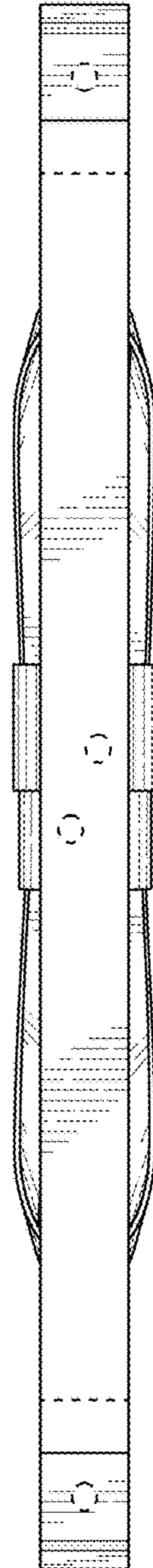

FIG. 5

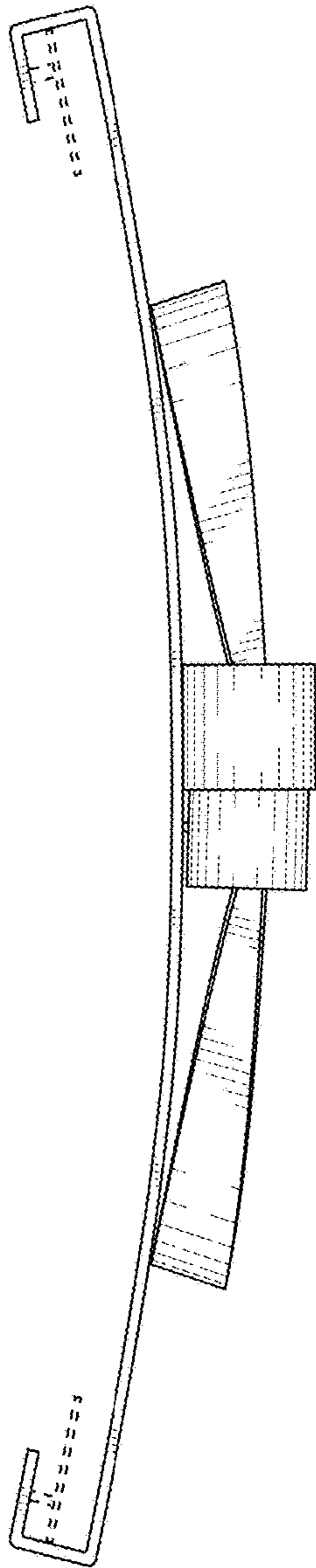

FIG. 6

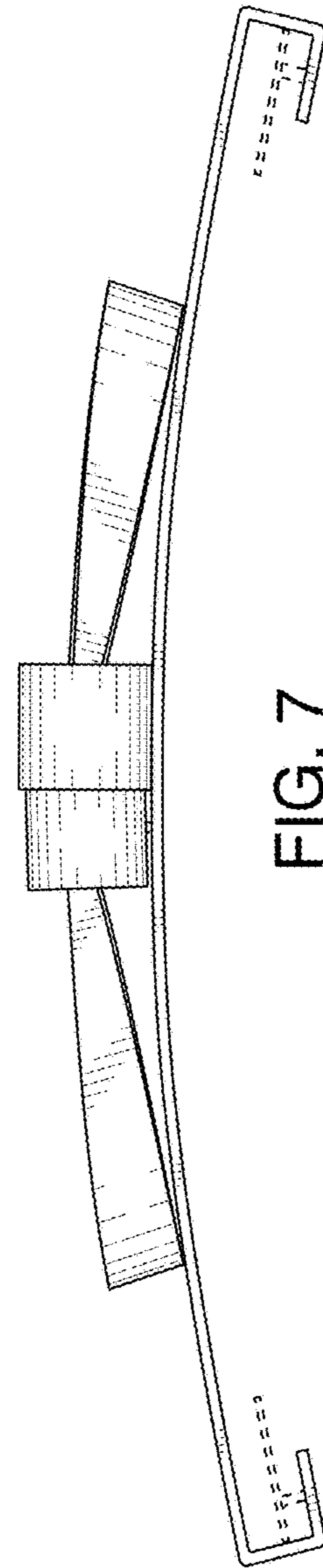

FIG. 7

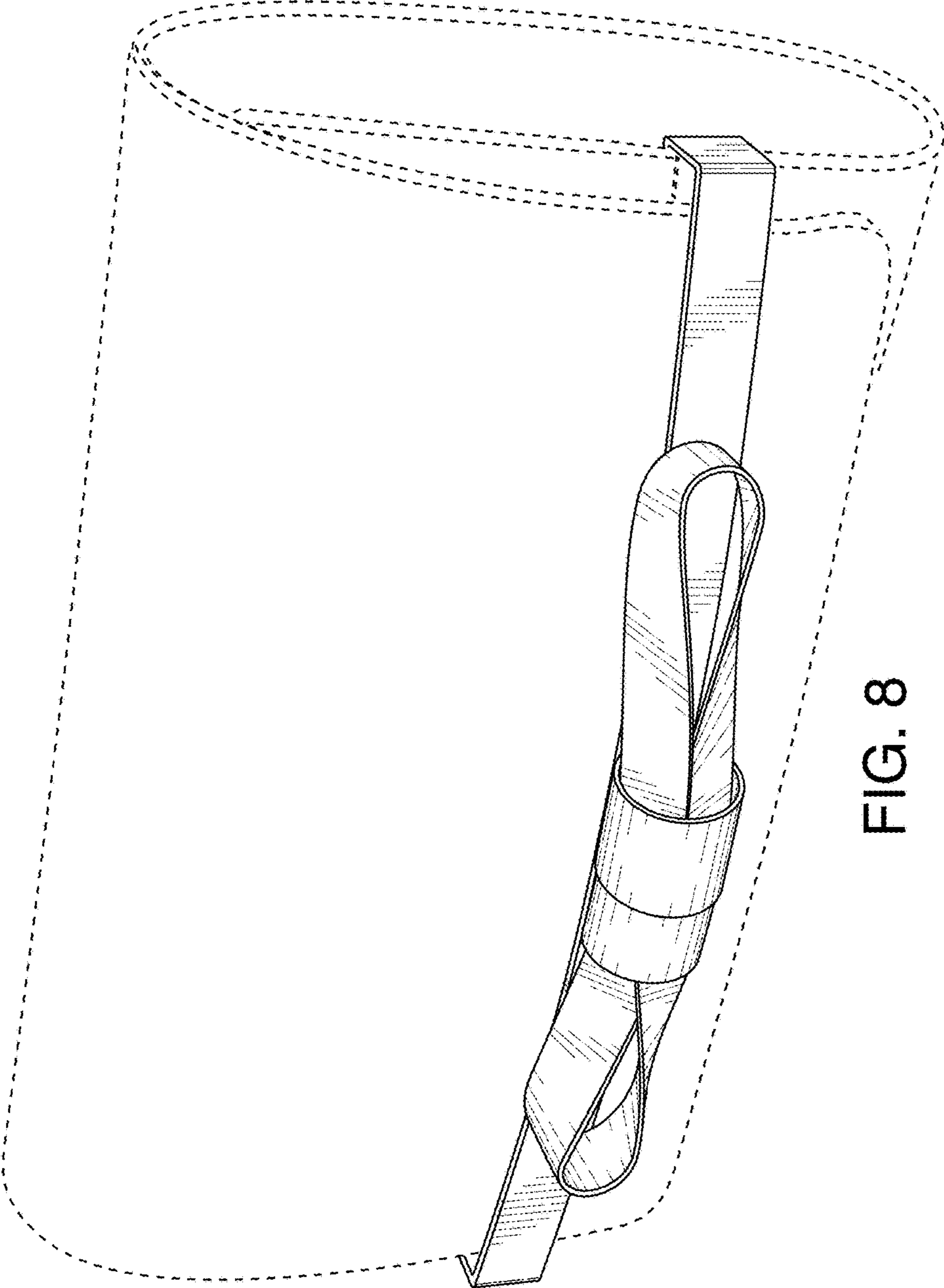

FIG. 8

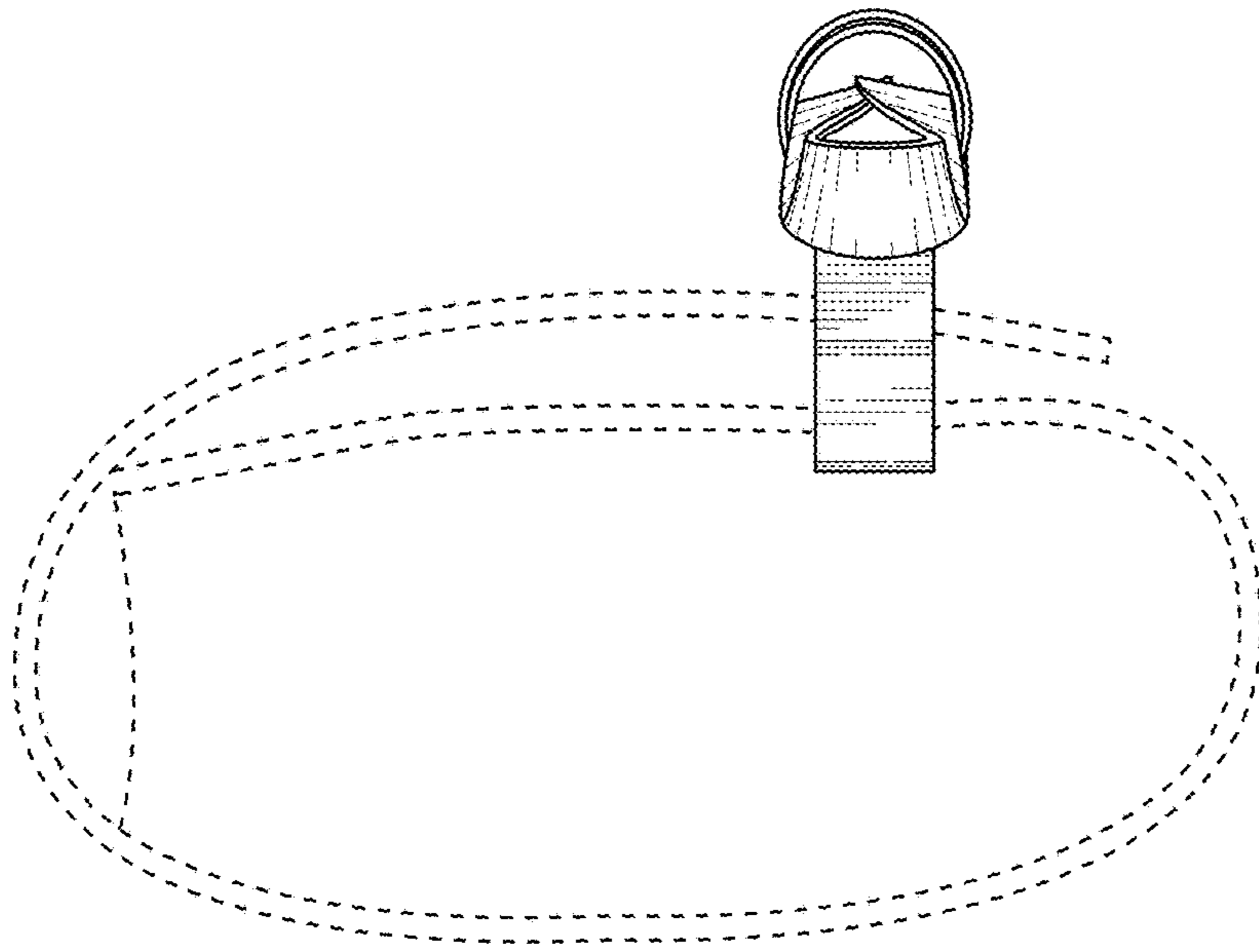

FIG. 10

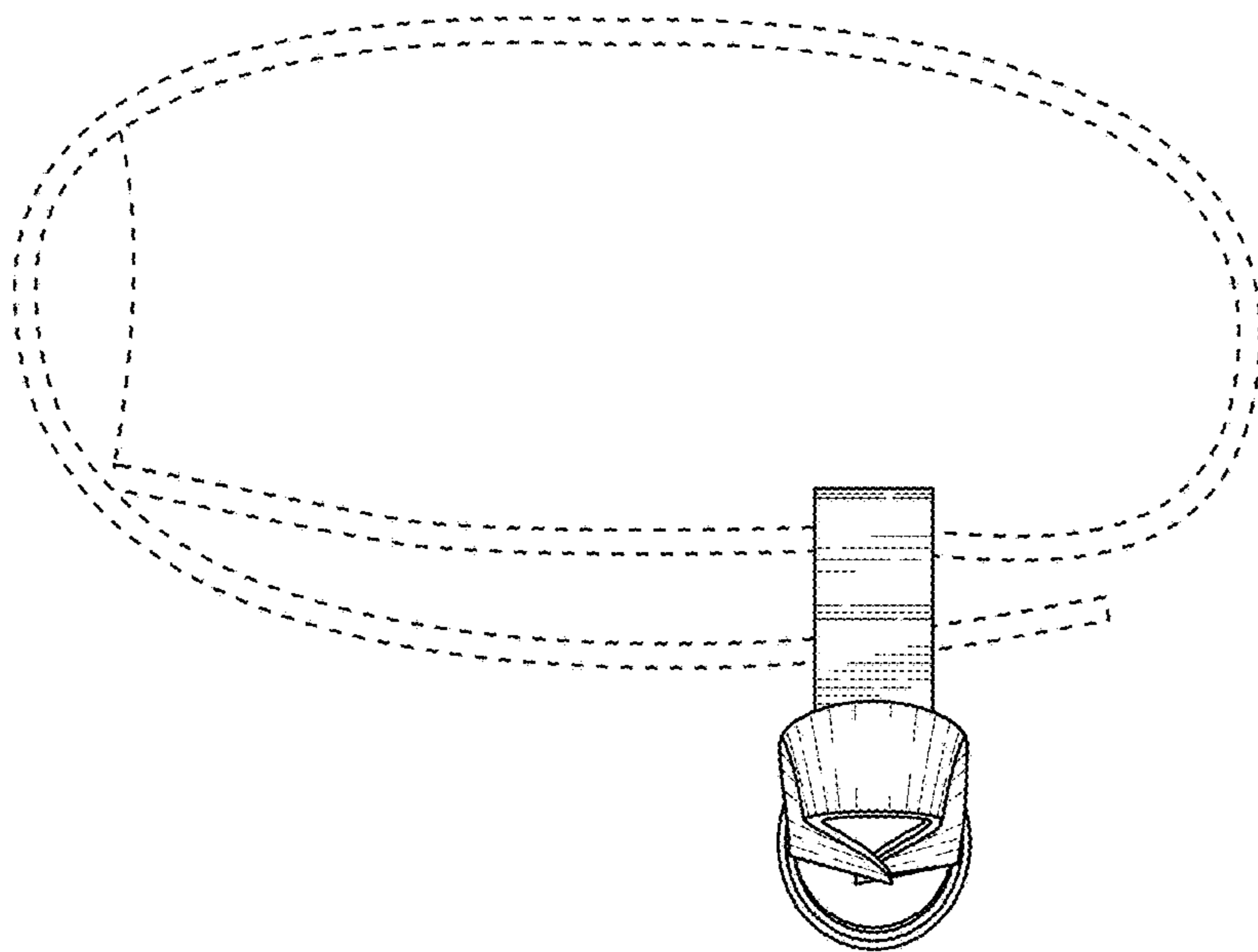

FIG. 9

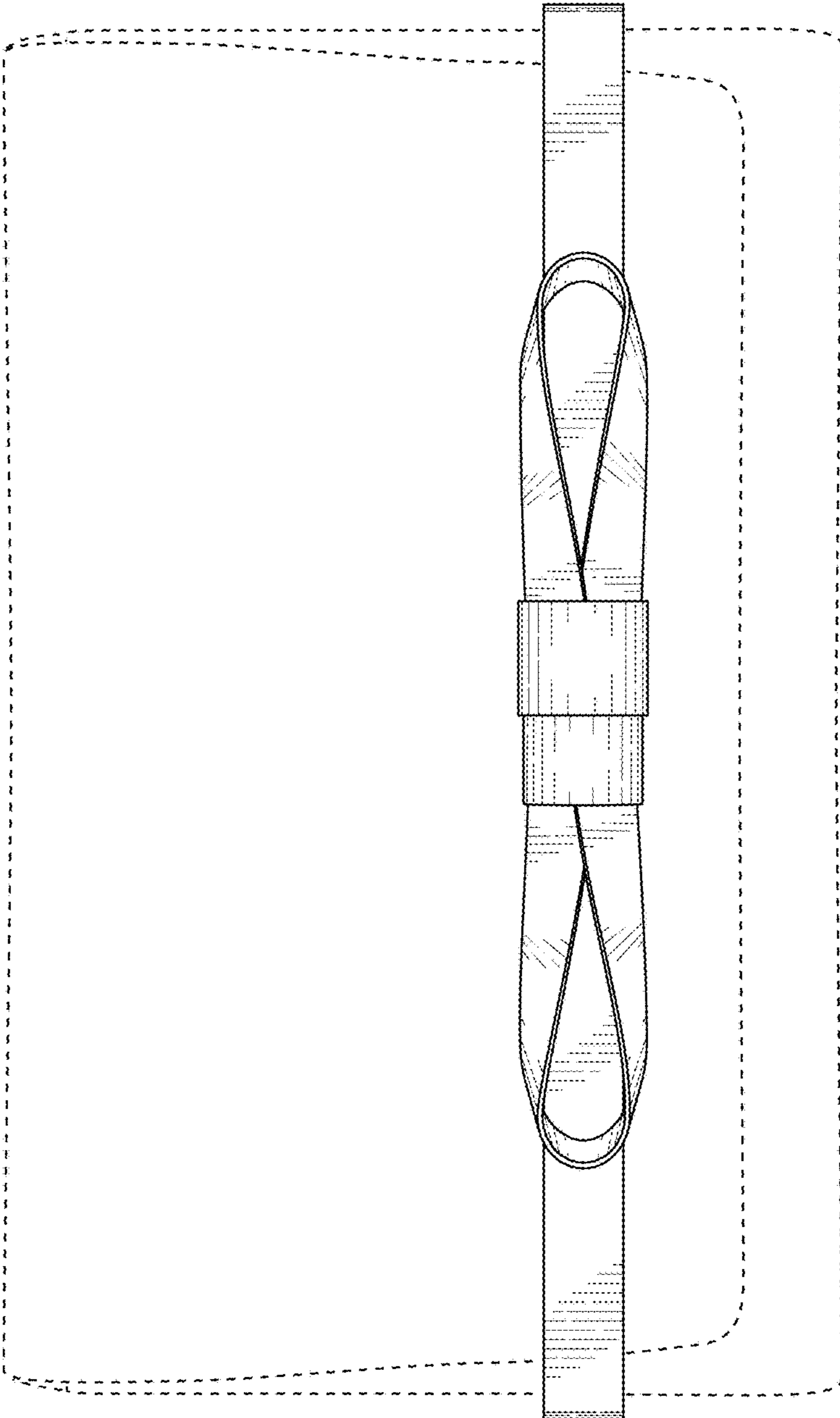

FIG. 11



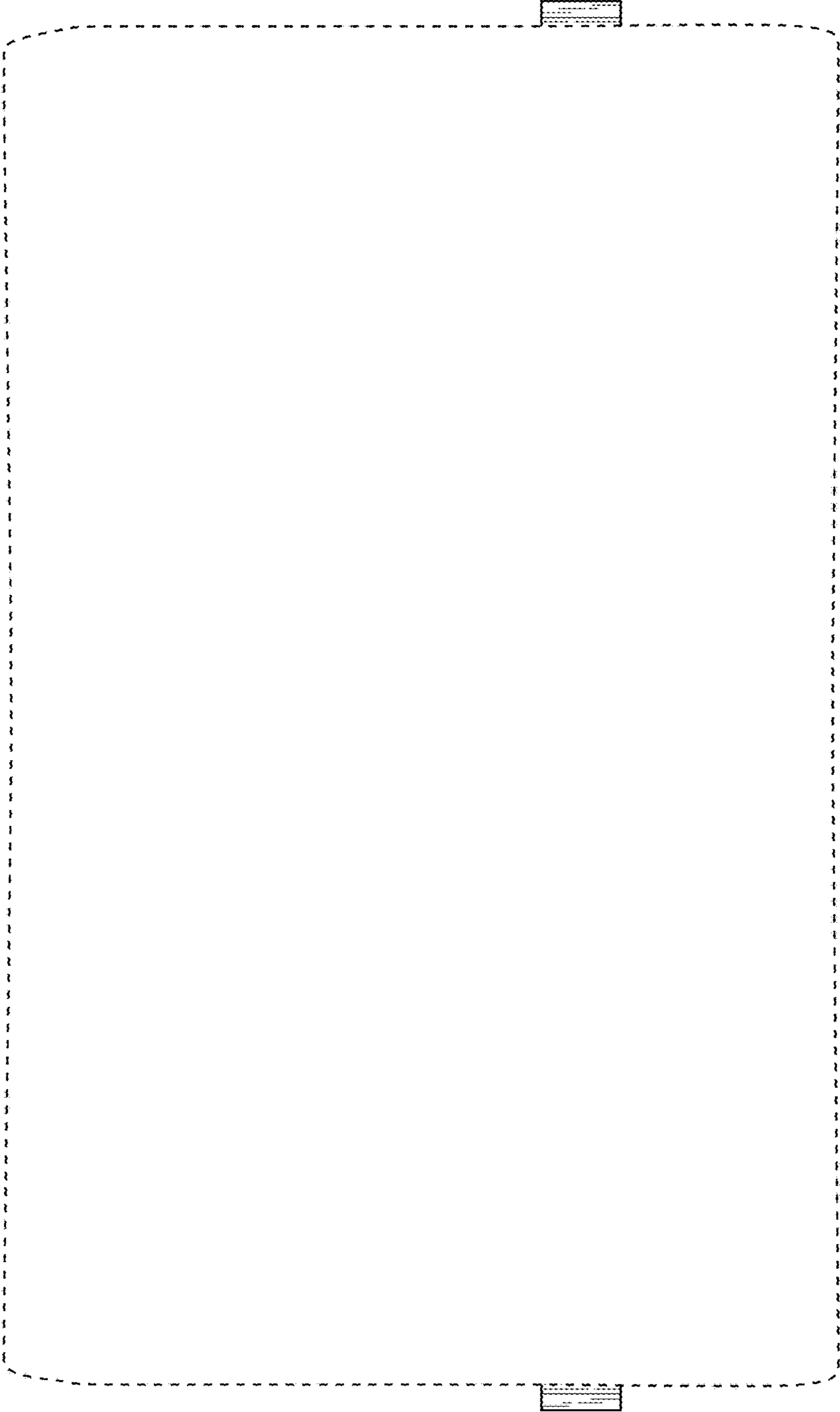

FIG. 12

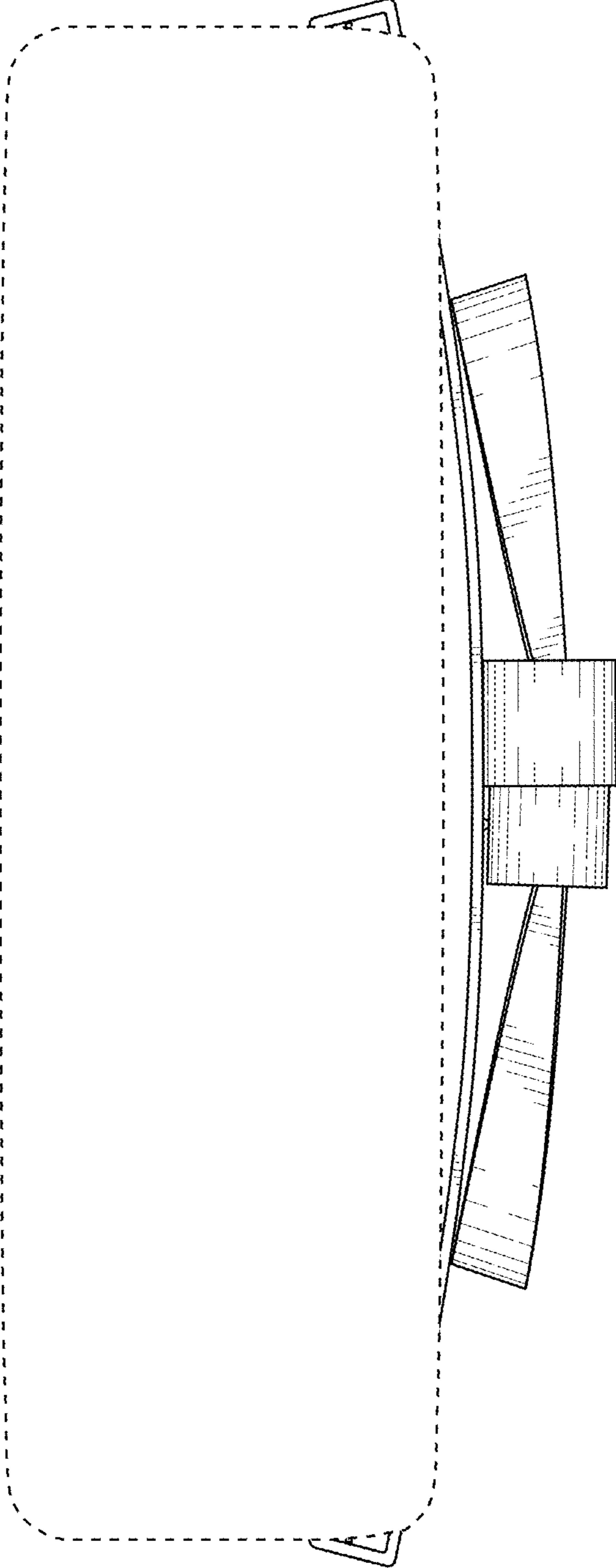

FIG. 13

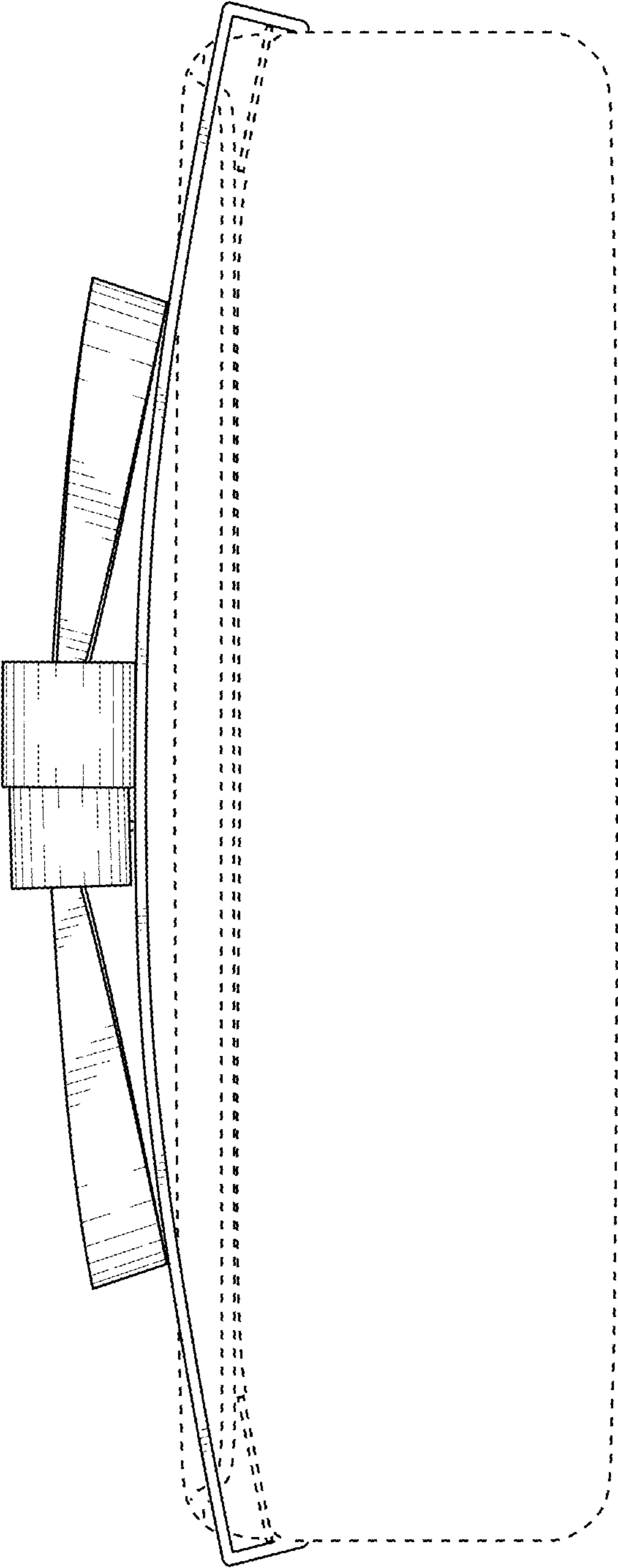

FIG. 14