



US00D817616S

(12) **United States Design Patent** (10) **Patent No.:** **US D817,616 S**  
**Cin** (45) **Date of Patent:** **\*\* May 15, 2018**

(54) **SHOE**

(71) Applicant: **NIKE, Inc.**, Beaverton, OR (US)

(72) Inventor: **David Cin**, Portland, OR (US)

(73) Assignee: **NIKE, Inc.**, Beaverton, OR (US)

(\*\*) Term: **15 Years**

(21) Appl. No.: **29/632,906**

(22) Filed: **Jan. 10, 2018**

**Related U.S. Application Data**

(63) Continuation of application No. 29/560,056, filed on Apr. 1, 2016, and a continuation of application No. 29/543,737, filed on Oct. 27, 2015, and a continuation of application No. 29/527,499, filed on May 19, 2015.

(51) **LOC (11) Cl.** ..... **02-04**

(52) **U.S. Cl.**  
USPC ..... **D2/947; D2/960**

(58) **Field of Classification Search**  
USPC ..... D2/902, 906, 908, 916, 918, 925, D2/946-962, 977; 36/1, 1.5, 3 B, 22 R, 36/24.5, 25 R, 28, 32 R, 34 R, 59 C, 36/67 A, 101-107, 114-116, 117.3, 117.4, 36/124-136  
CPC ..... A43B 13/00; A43B 13/02; A43B 13/023; A43B 13/026; A43B 13/04; A43B 13/08; A43B 13/10; A43B 13/12; A43B 13/14; A43B 13/141; A43B 13/143; A43B 13/16; A43B 13/18; A43B 13/181; A43B 13/187; A43B 13/189; A43B 13/20; A43B 13/22; A43B 13/223; A43B 13/24; A43B 13/28; A43B 13/30; A43B 13/32; A43B 13/34; A43B 13/36

See application file for complete search history.

(56) **References Cited**

U.S. PATENT DOCUMENTS

1,491,696 A	4/1924	Guinzburg
1,572,213 A	2/1926	Wilbert
1,773,127 A	8/1930	Auster
D118,606 S	1/1940	Friedman
2,205,577 A	6/1940	Roberts
2,447,590 A	8/1948	Meltzer
D155,816 S	11/1949	Little
D157,034 S	1/1950	Eldon
D235,701 S	7/1975	Famolare
D237,427 S	11/1975	Thornberry
D238,983 S	3/1976	Senter

(Continued)

OTHER PUBLICATIONS

Nike Revolution 4 Flyease, Nike.com, [online], [site visited Feb. 13, 2018]. <URL: <https://www.nike.com/t/revolution-4-flyease-mens-running-shoe-JI6Qct>> (Year: 2018).\*

(Continued)

*Primary Examiner* — T. Chase Nelson

*Assistant Examiner* — Jonathan J. Han

(74) *Attorney, Agent, or Firm* — Banner & Witcoff, Ltd.

(57) **CLAIM**

The ornamental design for a shoe, as shown and described.

**DESCRIPTION**

FIG. 1 is a front perspective view of a shoe showing my new design;

FIG. 2 is a side view thereof;

FIG. 3 is an opposite side view thereof;

FIG. 4 is a rear view thereof; and,

FIG. 5 is an enlarged partial view of FIG. 2.

The solid lines that are not immediately adjacent to the shaded area are claimed. The broken lines showing the remainder of the shoe represent unclaimed subject matter and form no part of the claimed design.

**1 Claim, 5 Drawing Sheets**

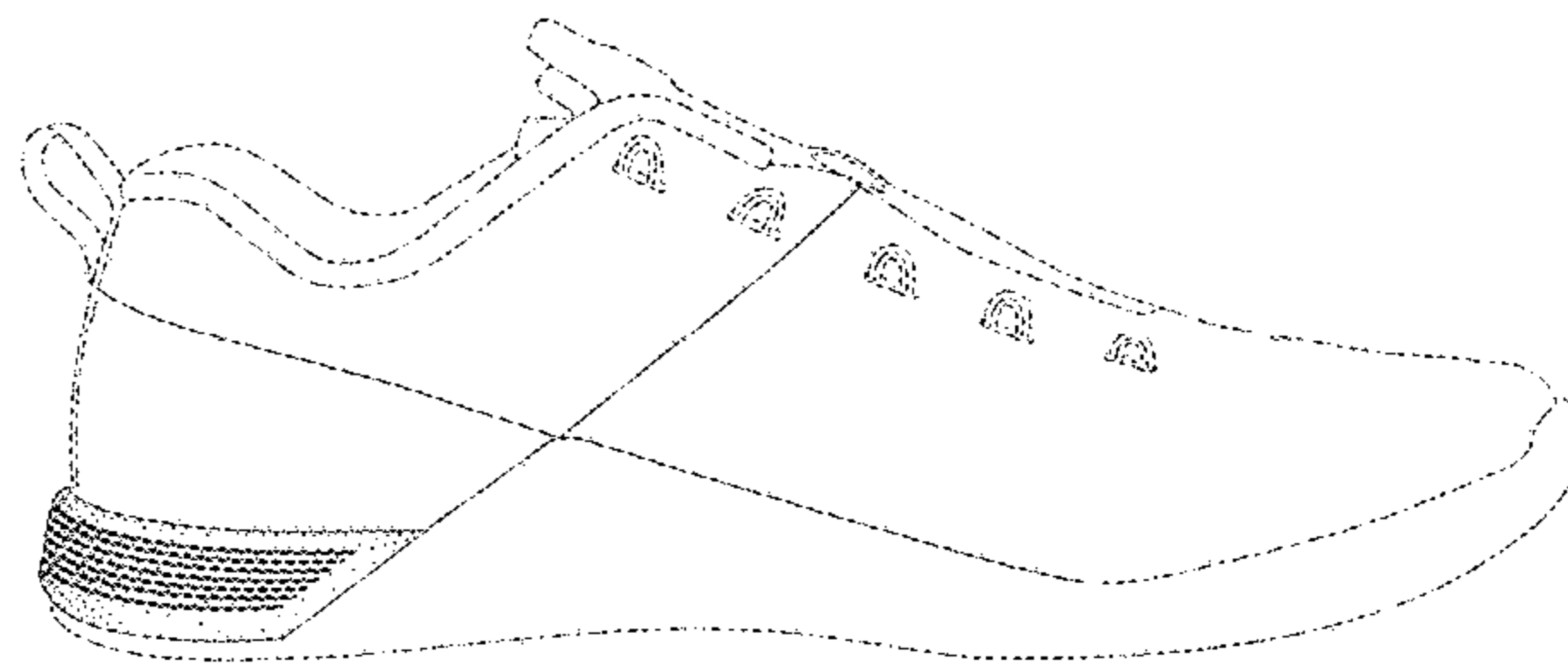
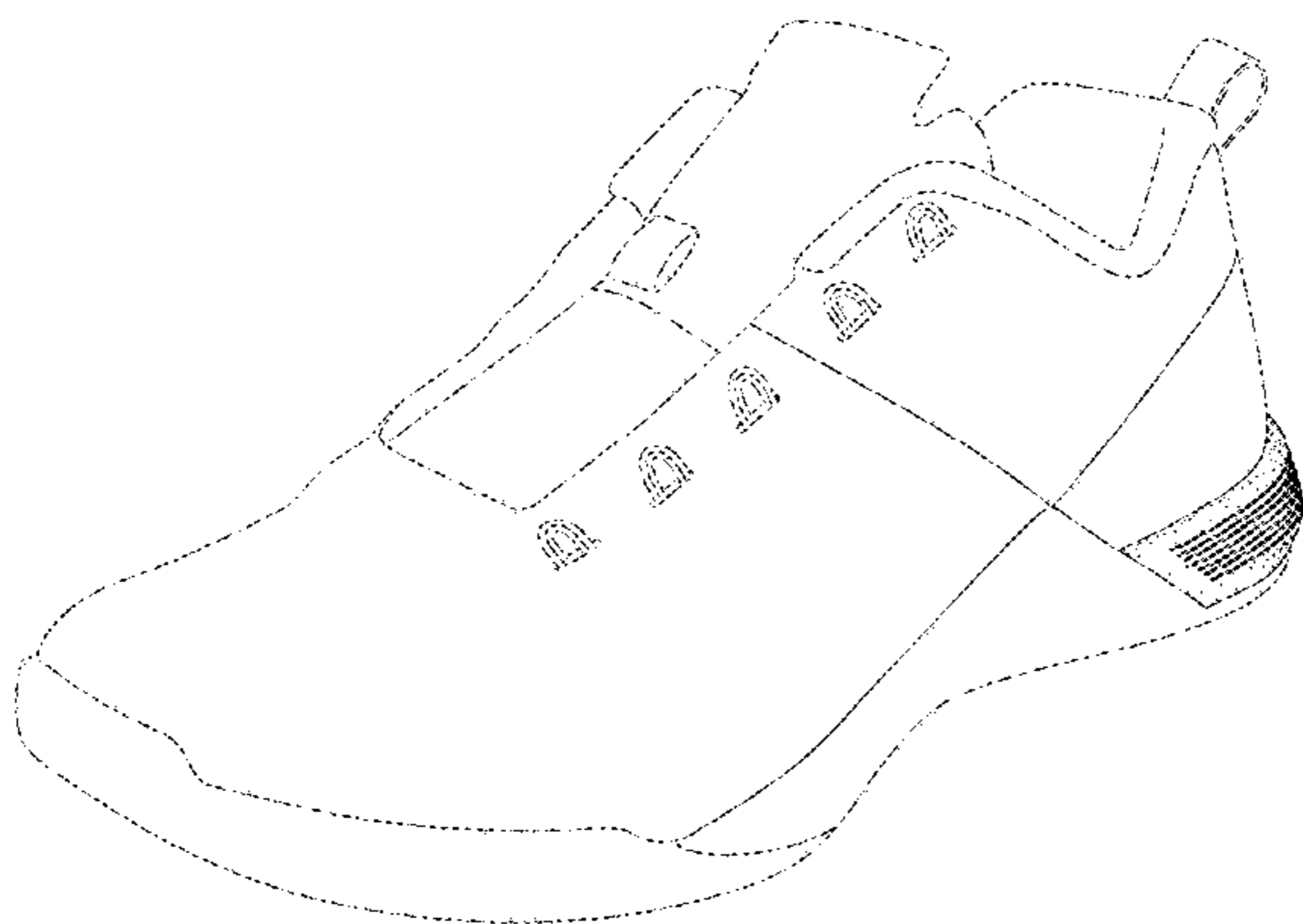

(56)

References Cited

U.S. PATENT DOCUMENTS

D263,643 S	4/1982	Vermonet	
D265,018 S	6/1982	Vermonet	
D265,144 S	6/1982	Vermonet	
D265,435 S	7/1982	Vermonet	
D266,285 S	9/1982	Vermonet	
D271,633 S	12/1983	Casetta	
4,624,062 A	11/1986	Autry	
D290,542 S	6/1987	O'Rourke	
4,670,998 A	6/1987	Pasternak	
D291,142 S	8/1987	Kelley	
D291,501 S	8/1987	Tong	
4,736,531 A	4/1988	Richard	
D296,611 S	7/1988	Brown et al.	
4,776,110 A	10/1988	Shiang	
D299,681 S	2/1989	Miller et al.	
D300,385 S	3/1989	Backus	
4,845,864 A	7/1989	Corliss	
4,852,276 A	8/1989	Savoca et al.	
4,876,806 A	10/1989	Robinson et al.	
D321,776 S	11/1991	Hatfield	
D323,055 S	1/1992	Cavasin	
D323,735 S	2/1992	Aveni	
D324,762 S *	3/1992	Hatfield	D2/977
D324,937 S	3/1992	Cavasin	
D324,938 S	3/1992	Cohen	
D325,288 S	4/1992	Richard et al.	
D325,289 S	4/1992	Aveni	
D326,015 S *	5/1992	Kayano	D2/953
D326,762 S	6/1992	Kiyosawa	
D326,763 S	6/1992	Holbrook	
D327,165 S *	6/1992	Hatfield	D2/953
D327,362 S	6/1992	Hatfield	
D329,739 S *	9/1992	Hatfield	D2/977
D329,937 S *	10/1992	Hatfield	D2/970
D329,941 S	10/1992	Hatfield	
D330,110 S	10/1992	Worthington	
D330,798 S	11/1992	Hatfield et al.	
D333,207 S	2/1993	Smith	
D334,650 S	4/1993	Teague	
D334,652 S	4/1993	Hatfield	
D336,560 S	6/1993	Peterson	
D336,771 S	6/1993	Hatfield et al.	
5,216,827 A	6/1993	Cohen	
D336,979 S	7/1993	Peterson	
D336,980 S	7/1993	Peterson	
D337,871 S	8/1993	Teague	
D338,326 S	8/1993	Dolinsky	
D339,447 S	9/1993	McDonald	
D339,456 S	9/1993	Kayano	
D340,128 S	10/1993	Mitsui	
D341,024 S	11/1993	Peterson	
D341,477 S	11/1993	Teague	
D341,700 S	11/1993	Avar	
D341,932 S	12/1993	Elliot	
D343,044 S	1/1994	Kilgore et al.	
D343,045 S	1/1994	Bailey	
D343,272 S	1/1994	James	
D347,936 S	6/1994	Takaoka	
D348,145 S	6/1994	Nakano	
5,319,866 A	6/1994	Foley et al.	
5,319,869 A	6/1994	McDonald et al.	
5,371,926 A	12/1994	Van Noy et al.	
D356,884 S	4/1995	Ho	
5,437,112 A	8/1995	Johnston	
5,465,509 A	11/1995	Fuerst et al.	
D374,337 S	10/1996	Murai et al.	
D393,358 S	4/1998	Teague	
D395,738 S	7/1998	Hatfield et al.	
5,784,807 A	7/1998	Pagel	
D398,743 S	9/1998	Rask	
D401,039 S	11/1998	Lupo	
D401,741 S	12/1998	Clarke	
D406,690 S *	3/1999	Vestuti	D2/916
D412,236 S	7/1999	von Conta	
5,918,338 A	7/1999	Wong	
D414,317 S	9/1999	Lubart	
D416,126 S	11/1999	Jimenez	
D418,282 S	1/2000	von Conta et al.	
D422,128 S	4/2000	Adler	
D431,349 S	10/2000	Matis et al.	
D437,477 S	2/2001	Tyler	
D441,175 S	5/2001	Ritter et al.	
D447,616 S	9/2001	Bandini et al.	
D452,362 S	12/2001	Mastroianni et al.	
D453,989 S	3/2002	Cagner	
D458,742 S	6/2002	Crary et al.	
6,412,196 B1	7/2002	Gross	
D465,905 S	11/2002	Meza et al.	
D466,277 S	12/2002	Smith, III	
D466,278 S	12/2002	Smith, III	
D468,085 S	1/2003	Baker	
6,523,282 B1	2/2003	Johnston	
D475,181 S	6/2003	McClaskie	
D476,471 S	7/2003	Alfaro	
6,606,804 B2	8/2003	Kaneko et al.	
D480,541 S	10/2003	Galway	
D486,632 S	2/2004	Adams	
D486,633 S	2/2004	Adams	
6,701,644 B2	3/2004	Oorei et al.	
6,708,427 B2	3/2004	Sussmann et al.	
D495,859 S	9/2004	Kubo et al.	
D498,352 S	11/2004	Ringholz et al.	
6,817,112 B2	11/2004	Berger et al.	
D507,097 S	7/2005	Sonnergren	
6,915,596 B2	7/2005	Grove et al.	
D511,886 S	11/2005	Galway	
D512,818 S	12/2005	Mitani et al.	
6,973,746 B2	12/2005	Auger et al.	
D515,286 S	2/2006	Dabah	
D516,783 S	3/2006	Chu	
D517,297 S	3/2006	Jones et al.	
7,010,872 B2	3/2006	Pawlus et al.	
D520,732 S	5/2006	Mitani et al.	
7,047,668 B2	5/2006	Burris et al.	
7,065,906 B2	6/2006	Jones et al.	
7,082,703 B2	8/2006	Greene et al.	
D528,778 S	9/2006	Avar et al.	
D545,551 S	7/2007	Duclos	
7,243,445 B2	7/2007	Manz et al.	
D549,949 S *	9/2007	Portzline	D2/972
D556,433 S	12/2007	Le	
7,328,527 B2	2/2008	Goldman	
D563,637 S	3/2008	Nakano	
7,337,558 B2	3/2008	Terlizzi et al.	
D571,997 S	7/2008	Teeter et al.	
D574,581 S	8/2008	Cooper	
D576,393 S	9/2008	Kaufman	
D582,644 S	12/2008	Belley et al.	
D586,105 S	2/2009	Banik et al.	
7,513,066 B2	4/2009	Kokstis et al.	
7,513,067 B2	4/2009	Marvin et al.	
D592,837 S	5/2009	Vico et al.	
7,526,881 B2	5/2009	Jones et al.	
D594,636 S	6/2009	Del Biondi et al.	
7,543,399 B2	6/2009	Kilgore et al.	
7,591,084 B2	9/2009	Santa Ana	
D603,598 S	11/2009	Bacon	
7,637,032 B2	12/2009	Sokolowski et al.	
D611,232 S	3/2010	Della Valle et al.	
D613,482 S	4/2010	Della Valle et al.	
7,694,438 B1	4/2010	Christensen et al.	
7,730,640 B2	6/2010	Clark et al.	
D618,894 S	7/2010	Taestensen	
D624,291 S	9/2010	Henderson	
7,814,686 B2	10/2010	Becker et al.	
D634,918 S	3/2011	Katz et al.	
7,895,772 B2	3/2011	Mariacher	
7,906,199 B2	3/2011	Rearick et al.	
D639,037 S	6/2011	McVicker et al.	
7,954,259 B2	6/2011	Antonelli et al.	
D643,189 S	8/2011	Teteriatnikov	
D643,602 S	8/2011	Teteriatnikov	
D644,418 S	9/2011	Yi	
8,028,442 B2	10/2011	Hodgson	

(56)

References Cited

U.S. PATENT DOCUMENTS

D648,514 S 11/2011 Avar  
 D653,842 S 2/2012 Weiss  
 D657,947 S 4/2012 Recchi et al.  
 8,146,273 B2 4/2012 Sokolowski  
 8,151,489 B2 4/2012 Marvin et al.  
 8,181,363 B2 5/2012 Klein  
 8,196,322 B2 6/2012 Atsumi et al.  
 D662,697 S 7/2012 Portzline  
 D663,933 S 7/2012 Lane  
 8,256,141 B2 9/2012 Christensen et al.  
 D671,306 S 11/2012 Tzenos  
 D671,723 S 12/2012 Teteriatnikov  
 8,356,429 B2 1/2013 Eder et al.  
 D676,635 S 2/2013 Bosomworth  
 D677,869 S 3/2013 Labarbera et al.  
 8,414,811 B1 4/2013 De Santis et al.  
 D682,515 S 5/2013 Della Valle et al.  
 D682,516 S 5/2013 Avar et al.  
 D685,166 S 7/2013 Hatfield et al.  
 D687,221 S 8/2013 Taylor  
 D689,273 S 9/2013 Hardman  
 D689,675 S 9/2013 Hardman  
 D690,088 S \* 9/2013 Hardman ..... D2/947  
 D691,785 S 10/2013 Chang  
 D692,217 S 10/2013 Fogg  
 D696,852 S 1/2014 Madore  
 D701,680 S 4/2014 Della Valle et al.  
 D702,025 S 4/2014 Della Valle et al.  
 D702,026 S 4/2014 Della Valle et al.  
 D708,828 S 7/2014 Avar et al.  
 8,789,298 B2 7/2014 Eder et al.  
 D713,624 S 9/2014 Petrie  
 D713,625 S 9/2014 Raasch  
 D713,636 S 9/2014 Cin  
 8,844,171 B2 9/2014 Eder et al.  
 8,850,721 B2 10/2014 Long et al.  
 8,869,431 B2 10/2014 Dimatteo  
 D717,526 S \* 11/2014 Cho ..... D2/909  
 D718,033 S 11/2014 Cin  
 8,887,411 B2 11/2014 Lacorazza et al.  
 D722,425 S 2/2015 Cin  
 D722,749 S 2/2015 Svensson et al.  
 8,959,796 B2 2/2015 Lazaris  
 9,032,645 B2 5/2015 Stauffer  
 9,038,288 B2 5/2015 Droege et al.  
 D731,761 S 6/2015 Carroll et al.  
 D731,767 S 6/2015 Lan  
 D732,284 S 6/2015 Yasui et al.  
 D737,037 S \* 8/2015 Dolce ..... D2/972  
 D737,038 S \* 8/2015 Dolce ..... D2/972  
 9,101,179 B2 8/2015 Marvin et al.  
 D738,092 S \* 9/2015 Caron ..... D2/972  
 D738,600 S 9/2015 Vasyli  
 D739,128 S 9/2015 Vasyli  
 9,173,448 B1 11/2015 Knoblauch  
 9,179,732 B2 11/2015 Minami  
 D745,771 S 12/2015 Cin  
 D748,899 S 2/2016 Bartel  
 9,295,304 B2 3/2016 Hatfield et al.  
 9,320,313 B2 4/2016 Craig et al.  
 D756,620 S \* 5/2016 Boys ..... D2/947  
 D761,005 S 7/2016 Nataadiningrat  
 D765,360 S 9/2016 Petrie  
 D765,363 S 9/2016 Petrie  
 D770,153 S \* 11/2016 Marvin ..... D2/951  
 D773,159 S 12/2016 Seamarks  
 D773,168 S \* 12/2016 Cin ..... D2/973  
 D778,551 S 2/2017 Pauk  
 D778,553 S \* 2/2017 DeAlmeida ..... D2/947  
 9,585,434 B2 3/2017 Van Atta et al.  
 D782,790 S \* 4/2017 Lee ..... D2/947  
 D783,995 S \* 4/2017 Kuerbis ..... D2/972  
 D789,659 S 6/2017 Stovall  
 D789,664 S \* 6/2017 Seo ..... D2/951  
 D789,674 S 6/2017 Williams, Jr.

9,675,130 B2 6/2017 Ueda et al.  
 D791,453 S \* 7/2017 McMillan ..... D2/947  
 9,693,604 B2 7/2017 Cin et al.  
 D793,046 S \* 8/2017 Lee ..... D2/947  
 D794,290 S \* 8/2017 Nethongkome ..... D2/947  
 D794,293 S 8/2017 Robusti  
 D794,294 S 8/2017 Robusti  
 D794,296 S \* 8/2017 Lee ..... D2/947  
 D795,541 S \* 8/2017 Henrichot ..... D2/947  
 D796,802 S 9/2017 Kinley  
 D796,804 S 9/2017 Young  
 D796,816 S \* 9/2017 Klein ..... D2/972  
 9,750,304 B2 9/2017 Kohatsu et al.  
 D798,555 S \* 10/2017 Enayah ..... D2/947  
 D798,559 S \* 10/2017 Pauk ..... D2/947  
 D799,180 S 10/2017 Sokol  
 D799,807 S \* 10/2017 Sokol ..... D2/972  
 D802,266 S \* 11/2017 Hardman ..... D2/947  
 D802,280 S \* 11/2017 Comeaux ..... D2/972  
 D802,283 S \* 11/2017 McCullagh ..... D2/972  
 D802,284 S \* 11/2017 McCullagh ..... D2/972  
 D807,014 S \* 1/2018 Sullivan ..... D2/972  
 D807,632 S \* 1/2018 Sullivan ..... D2/972  
 D808,631 S \* 1/2018 Enayah ..... D2/972  
 9,867,426 B2 \* 1/2018 Conant ..... A43B 13/186  
 2004/0128863 A1 7/2004 Hong et al.  
 2004/0244226 A1 12/2004 Farys et al.  
 2005/0257402 A1 11/2005 Kobayashi  
 2006/0059716 A1 3/2006 Yamashita et al.  
 2008/0034613 A1 2/2008 Wilkenfeld et al.  
 2010/0083541 A1 4/2010 Baucom et al.  
 2010/0115796 A1 5/2010 Pulli  
 2010/0287792 A1 11/2010 Hide  
 2011/0185597 A1 8/2011 Guest  
 2012/0304503 A1 12/2012 Bouvet et al.  
 2013/0031805 A1 \* 2/2013 Crowley, II ..... A43B 7/144  
 36/103  
 2013/0312284 A1 \* 11/2013 Berend ..... A43B 1/0027  
 36/84  
 2014/0150298 A1 \* 6/2014 Crowley ..... A43B 7/1445  
 36/103  
 2015/0173454 A1 6/2015 Perez et al.  
 2015/0181976 A1 7/2015 Cooper et al.  
 2015/0257489 A1 9/2015 Trudel  
 2015/0342292 A1 12/2015 Mariacher  
 2015/0342300 A1 \* 12/2015 Cin ..... A43B 17/003  
 36/103  
 2016/0095384 A1 4/2016 Kraft  
 2016/0143386 A1 \* 5/2016 Cone ..... A43B 3/16  
 36/7.1 R  
 2016/0174660 A1 6/2016 Iuchi et al.  
 2016/0213095 A1 7/2016 Kohatsu et al.  
 2016/0262494 A1 9/2016 Weidl  
 2016/0286898 A1 10/2016 Manz et al.  
 2016/0295955 A1 10/2016 Wardlaw et al.  
 2016/0338449 A1 11/2016 Steuerwald  
 2017/0156439 A1 6/2017 Yoshida et al.  
 2017/0251761 A1 9/2017 Cin et al.  
 2017/0258179 A1 9/2017 Conant et al.

OTHER PUBLICATIONS

Jordan Ultra Fly 2 Low, Nike.com, [online], [site visited Feb. 13, 2018]. <URL: <https://www.nike.com/t/jordan-ultra-fly-2-low-mens-basketball-shoe-bky9JP>> (Year: 2018).\*

Nike Tiempox Legend VII Academy IC, Nike.com, [online], [site visited Feb. 13, 2018]. <URL: <https://www.nike.com/t/tiempox-legend-vii-academy-indoor-court-soccer-shoe-8g0JDn>> (Year: 2018).\*

Nike Metcon 3 Realtree, Nike.com, [online], [site visited Feb. 13, 2018]. <URL: <https://www.nike.com/t/metcon-3-realtree-mens-training-shoe-qkJoMK>> (Year: 2018).\*

Nike MetCon Crossfit Shoes Review, YouTube.com, RIZKNOWS, Published on Mar. 28, 2015, [online], [site visited Feb. 13, 2018]. <URL: <https://www.youtube.com/watch?v=XJN6cMGpvIM>> (Year: 2015).\*

(56)

**References Cited**

## OTHER PUBLICATIONS

Nike Footwear Catalog, 1986 Fall Performance, p. 92, published Jan. 1986, NIKE, Inc., USA.  
Nike Footwear Catalog, 1986 Fall Performance, p. 58, published Jan. 1986, NIKE, Inc., USA.  
Nike Footwear Catalog, 1987 Fall Footwear, p. 96, published Jan. 1987, NIKE, Inc., USA.  
Nike Footwear Catalog, 1988 Fall Footwear, p. 52, published Dec. 1987, NIKE, Inc., USA.  
Nike Footwear Catalog, 1988 Fall Footwear, p. 54, published Dec. 1987, NIKE, Inc., USA.  
Nike Footwear Catalog, 1989 Fall Footwear, p. 26, published Dec. 1988, NIKE, Inc., USA.  
Nike Footwear Catalog, 1989 Fall Footwear, p. 46, published Dec. 1988, NIKE, Inc., USA.  
Nike Footwear Catalog, 1989 Fall Footwear, p. 70, published Dec. 1988, NIKE, Inc., USA.  
Nike Footwear Catalog, 1990 Fall Footwear, p. 84, published Dec. 1989, NIKE, Inc., USA.  
Nike Footwear Catalog, 1990 Spring Footwear, p. 4, published Jun. 1989, NIKE, Inc., USA.  
Nike Footwear Catalog, 1990 Spring Footwear, p. 96, published Jun. 1989, NIKE, Inc., USA.  
Nike Footwear Catalog, 1991 Fall Footwear, p. 120, published Dec. 1990, NIKE, Inc., USA.  
Nike Footwear Catalog, 1991 Spring Footwear, p. 46, published Jun. 1990, NIKE, Inc., USA.

Nike Footwear Catalog, 1991 Spring Footwear, p. 82, published Jun. 1990, NIKE, Inc., USA.  
Nike Footwear Catalog, 2006 Fall Footwear, p. 44, published Nov. 2005, NIKE, Inc., USA.  
Nike Footwear Catalog, 2010 Fall Performance Footwear, p. 78, published Nov. 2009, NIKE, Inc., USA.  
Nike Footwear Catalog, 2011 Fall Men's Performance Footwear, p. 45, published Nov. 2010, NIKE, Inc., USA.  
Nike Footwear Catalog, 2011 Fall Men's Performance Footwear, p. 66, published Nov. 2010, NIKE, Inc., USA.  
Nike Footwear Catalog, 2011 Spring Men's Running Footwear, p. 35, published date unknown, but prior to the filing date of the present application, NIKE, Inc., USA.  
Nike Footwear Catalog, 2012 Fall Men's Footwear Sportswear Best, p. 32, published Nov. 2011, NIKE, Inc., USA.  
Nike Footwear Catalog, 2013 Fall City Specialty Best NA, p. 32, published Nov. 1, 2013, NIKE, Inc., USA.  
Nike Footwear Catalog, 2013 Holiday City Specialty Footwear, p. 38, published Feb. 2013, NIKE, Inc., USA.  
Nike Footwear Catalog, 2014 Fall Core Performance Footwear Final Low, p. 22, published Nov. 1, 2013, NIKE, Inc., USA.  
Nike Footwear Catalog, 2014 Fall Sporting Goods Footwear Best, p. 223, published Nov. 1, 2013, NIKE, Inc., USA.  
Nike Training Introduces the Much-Anticipated Nike Metcon 1, [online], [retrieved Jan. 9, 2018], 7 color sheets. <URL: <<https://news.nike.com/news/nike-training-introduces-the-much-anticipated-metcon-1>>> Publish date Jan. 28, 2015.

\* cited by examiner

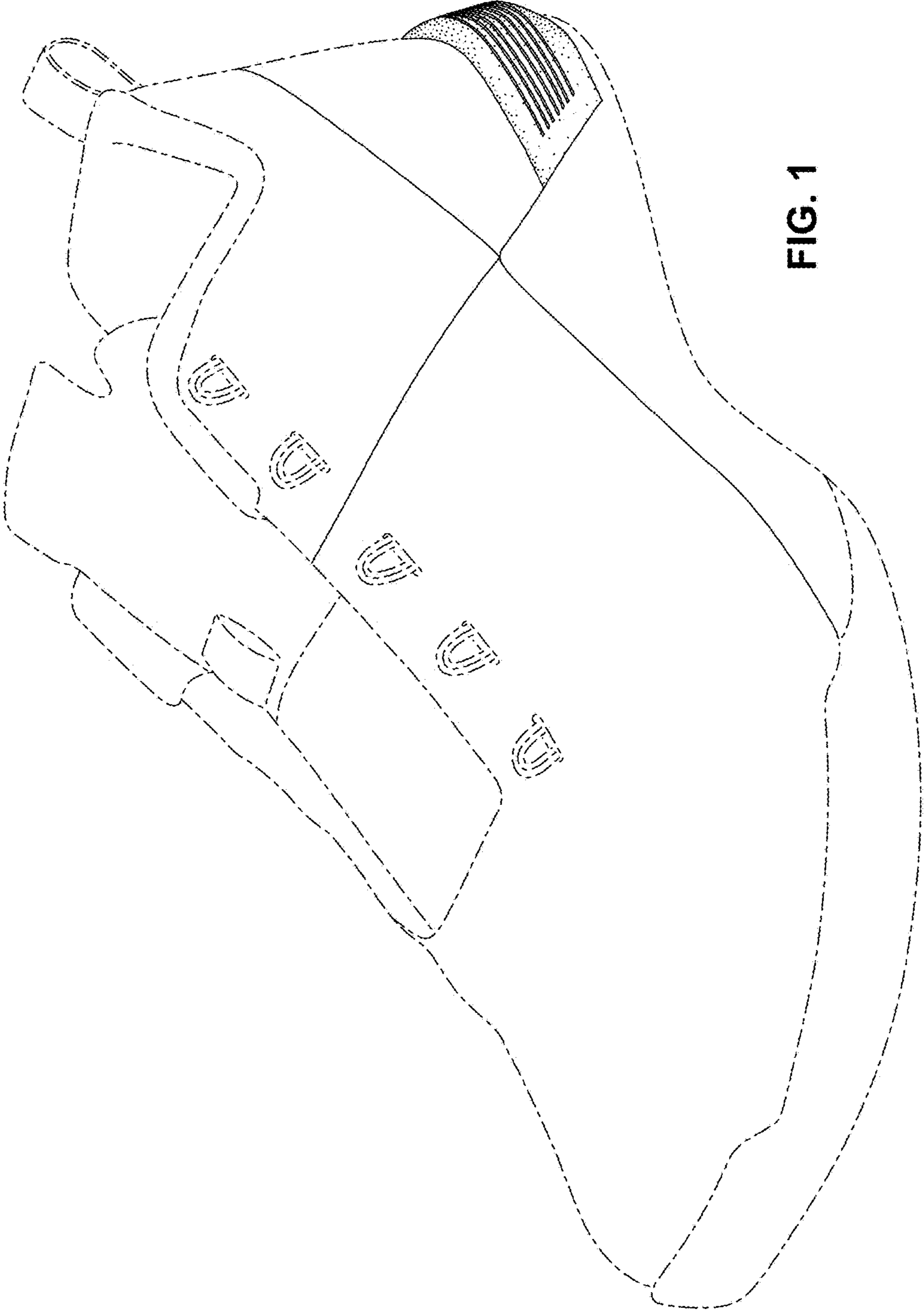

FIG. 1

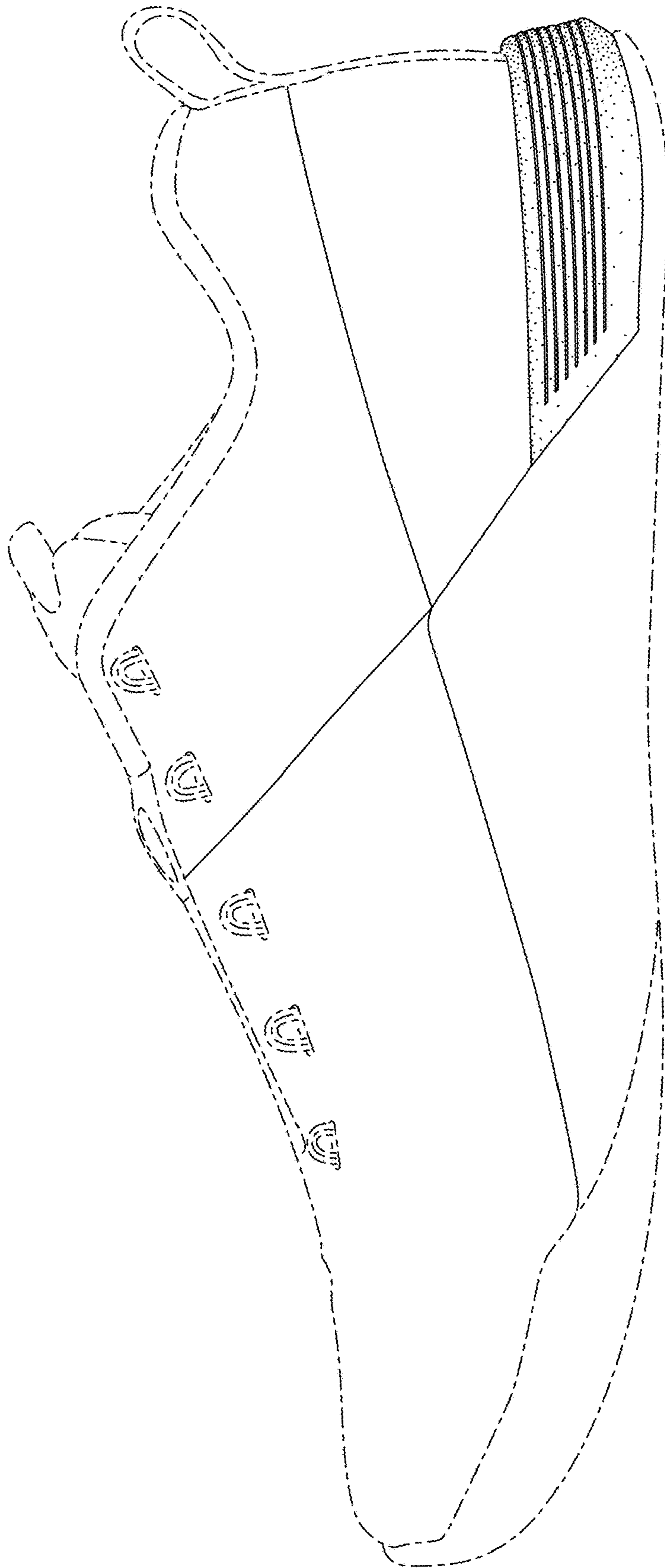

FIG. 2

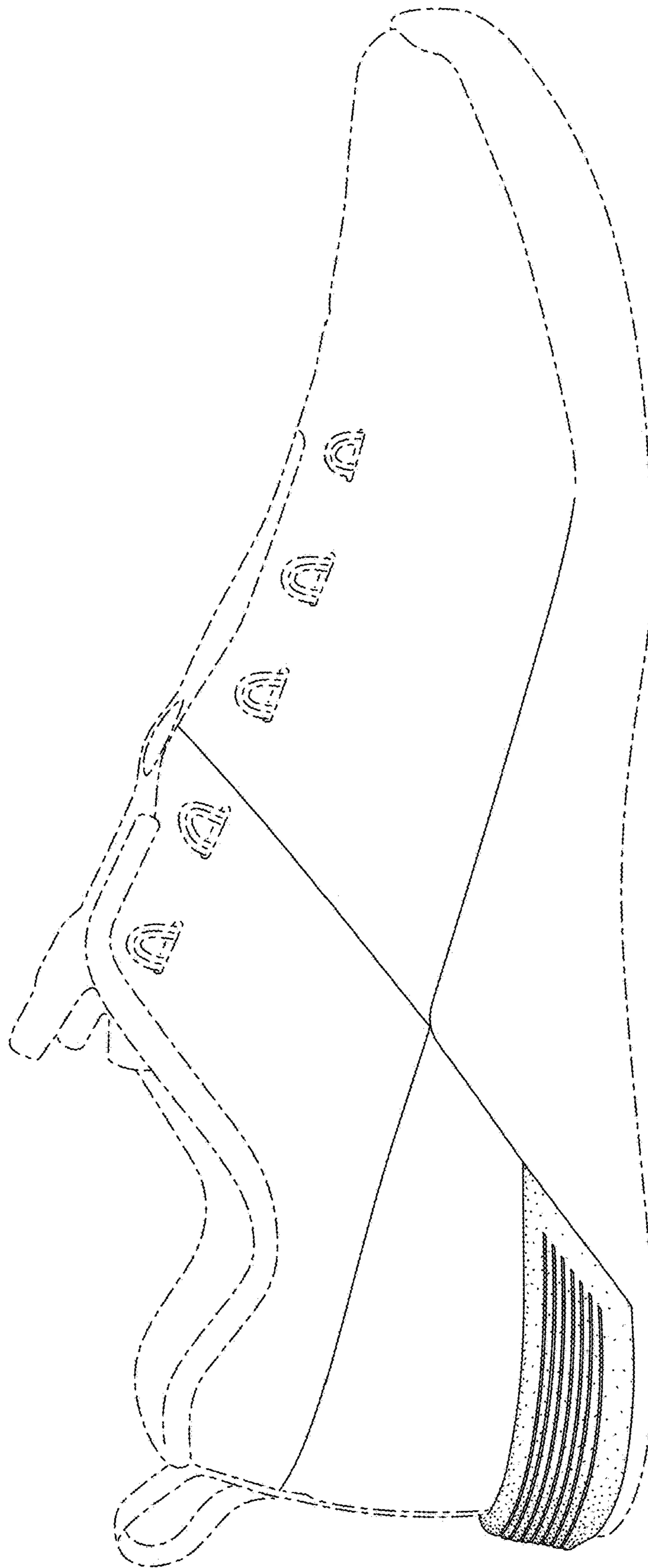

FIG. 3

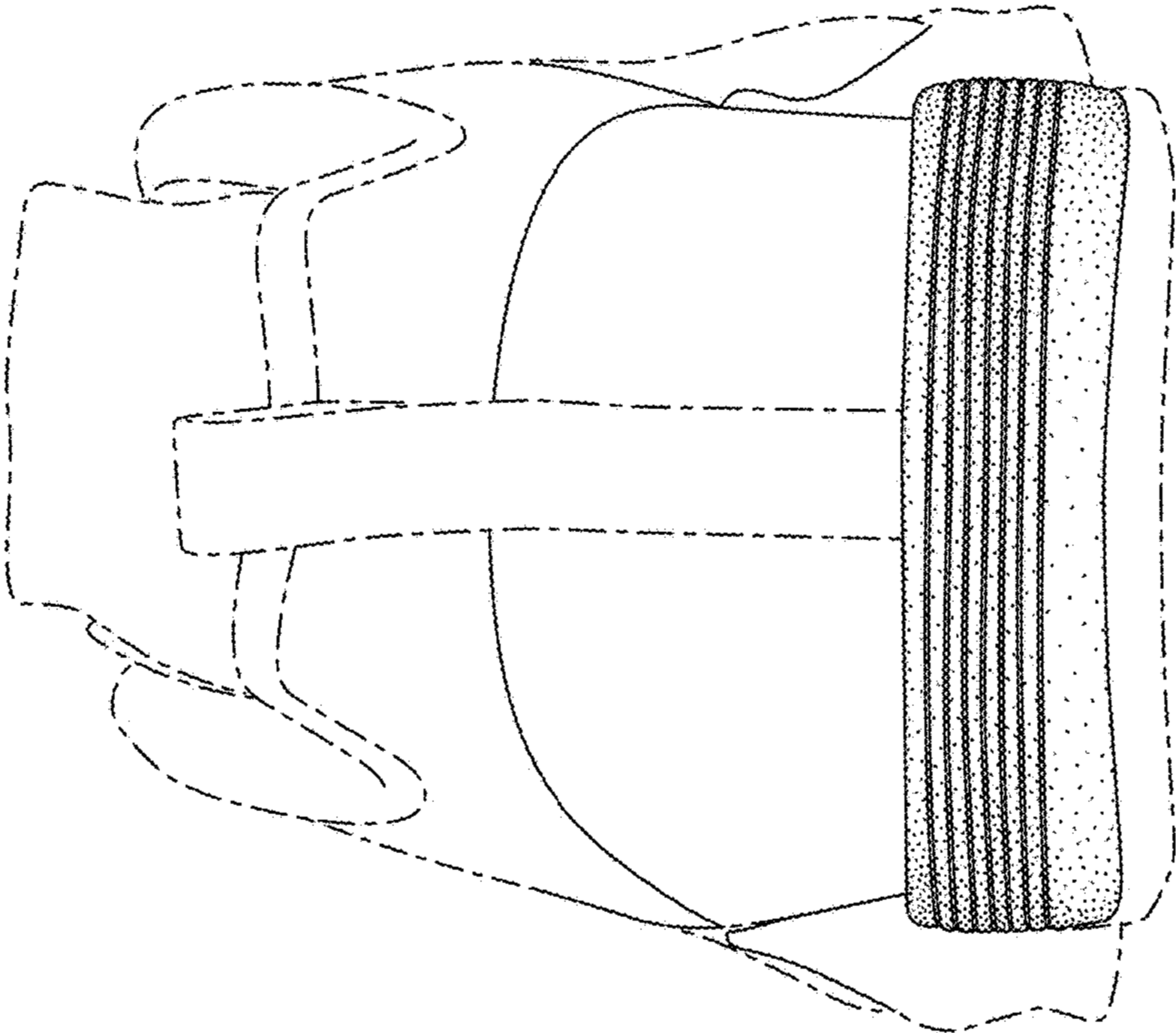

FIG. 4



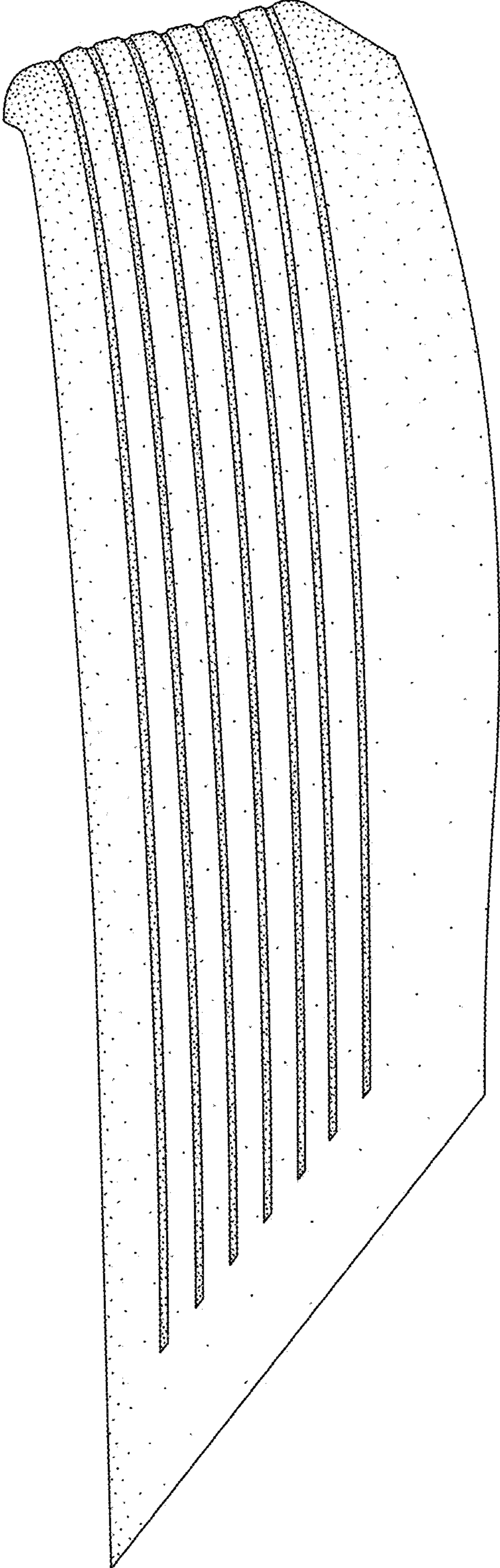

FIG. 5