



US00D817609S

(12) **United States Design Patent** (10) **Patent No.:** **US D817,609 S**  
**Boys et al.** (45) **Date of Patent:** **\*\* May 15, 2018**

(54) **SHOE**  
(71) Applicant: **Cole Haan LLC**, New York, NY (US)  
(72) Inventors: **Jack Boys**, New York, NY (US); **Ann Bono**, New York, NY (US); **Aubert Shepherd**, Greenland, NH (US); **Mattias Verfl**, Brooklyn, NY (US)  
(73) Assignee: **COLE HAAN LLC**, New York, NY (US)

3,968,293 A \* 7/1976 Cunningham ..... B29C 67/202  
264/41  
D309,370 S \* 7/1990 Nagai ..... D2/953  
D487,336 S 3/2004 Matis  
D525,775 S 8/2006 Cintron  
D541,521 S 5/2007 Smith et al.  
D595,938 S \* 7/2009 Fuchs ..... D2/907  
D598,190 S 8/2009 Weber  
D635,748 S \* 4/2011 Katz ..... D2/902  
D663,519 S 7/2012 Grangaard  
D707,022 S \* 6/2014 Della Valle ..... D2/944  
(Continued)

(\*\*) Term: **15 Years**  
(21) Appl. No.: **29/570,512**  
(22) Filed: **Jul. 8, 2016**  
(51) **LOC (11) Cl.** ..... **02-04**  
(52) **U.S. Cl.**  
USPC ..... **D2/945; D2/908**  
(58) **Field of Classification Search**  
USPC ..... D2/896, 897, 900, 902, 907, 908, 909,  
D2/912, 919, 920, 923, 929, 942, 943,  
D2/944, 945, 946, 951, 953, 955, 960,  
D2/969, 972, 974, 976  
CPC .... A43B 1/04; A43B 5/06; A43B 5/10; A43B  
23/24  
See application file for complete search history.

**OTHER PUBLICATIONS**

“Introducing the Innovative Cole Haan Zerøgrand Stitchlite Oxford,” as posted on KicksOnFire.com, posted Feb. 2, 2017, [site visited Jun. 22, 2017]. Available on the Internet, <URL:https://www.kicksonfire.com/cole-haan-zero-grand-stitchlite/>.  
(Continued)

*Primary Examiner* — Celia Murphy  
*Assistant Examiner* — Clare Ann Gannon  
(74) *Attorney, Agent, or Firm* — Thompson Coburn LLP

(57) **CLAIM**

The ornamental design for a shoe, as shown and described.

**DESCRIPTION**

FIG. 1 is a perspective view of a shoe showing our new design;  
FIG. 2 is a top plan view thereof;  
FIG. 3 is a lateral side view thereof;  
FIG. 4 is a medial side view thereof;  
FIG. 5 is a front view thereof;  
FIG. 6 is a rear view thereof; and,  
FIG. 7 is a bottom plan view thereof.  
The broken lines depicting the tongue, heel pull-strap, eyelets, and inside surfaces of the shoe form no part of the claimed design.

**1 Claim, 6 Drawing Sheets**

(56) **References Cited**  
U.S. PATENT DOCUMENTS  
D73,396 S \* 9/1927 Bates ..... D2/944  
D90,234 S 7/1933 Daniels  
D96,687 S 8/1935 Lutz  
2,014,094 A \* 9/1935 Wiggin ..... A43B 3/14  
36/11  
D108,128 S \* 1/1938 Pick ..... D2/974  
D108,334 S 2/1938 Lutz  
D119,276 S 3/1940 Lutz  
D130,845 S 12/1941 Pick  
D158,953 S \* 6/1950 Gillis ..... D2/907

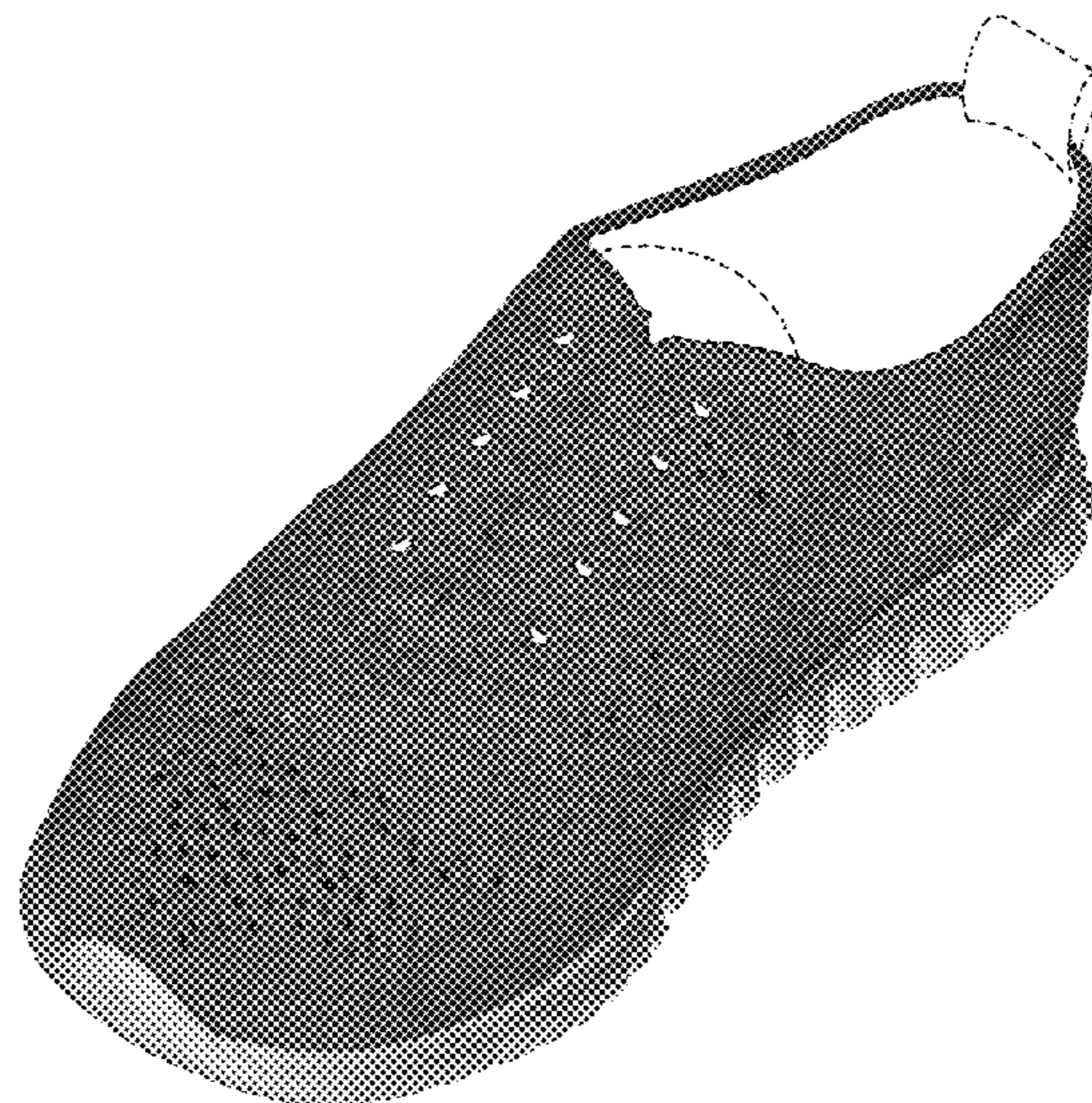

(56)

**References Cited**

## U.S. PATENT DOCUMENTS

D707,943	S	7/2014	Nascimento	
D722,225	S	2/2015	Williams, Jr.	
D723,772	S *	3/2015	Miner .....	D2/947
D728,205	S *	5/2015	Weddle .....	D2/906
D730,035	S *	5/2015	Henderson .....	D2/947
D748,386	S *	2/2016	Henderson .....	D2/947
D752,329	S	3/2016	Kirschner	
D759,365	S	6/2016	Henderson et al.	
D767,268	S *	9/2016	Avar .....	D2/974
D772,553	S	11/2016	Williams, Jr.	
D774,287	S *	12/2016	Taestensen .....	D2/908
D779,184	S	2/2017	Avar et al.	
D783,975	S *	4/2017	Schenone .....	D2/902
D787,170	S	5/2017	Mokos et al.	
D793,044	S *	8/2017	Mokos .....	D2/944

## OTHER PUBLICATIONS

Cole Haan, Women's Zero Grand Stitchlite Wingtip Oxford—Ironstone Knit—Tropical Peach, as posted at ShopSpring.com <<http://ShopSpring.com>> [online], posting date not available, [site visited Jun. 23, 2017]. Available on the Internet, <URL: <<https://www.shopspring.com/products/53199277>>>.

\* cited by examiner

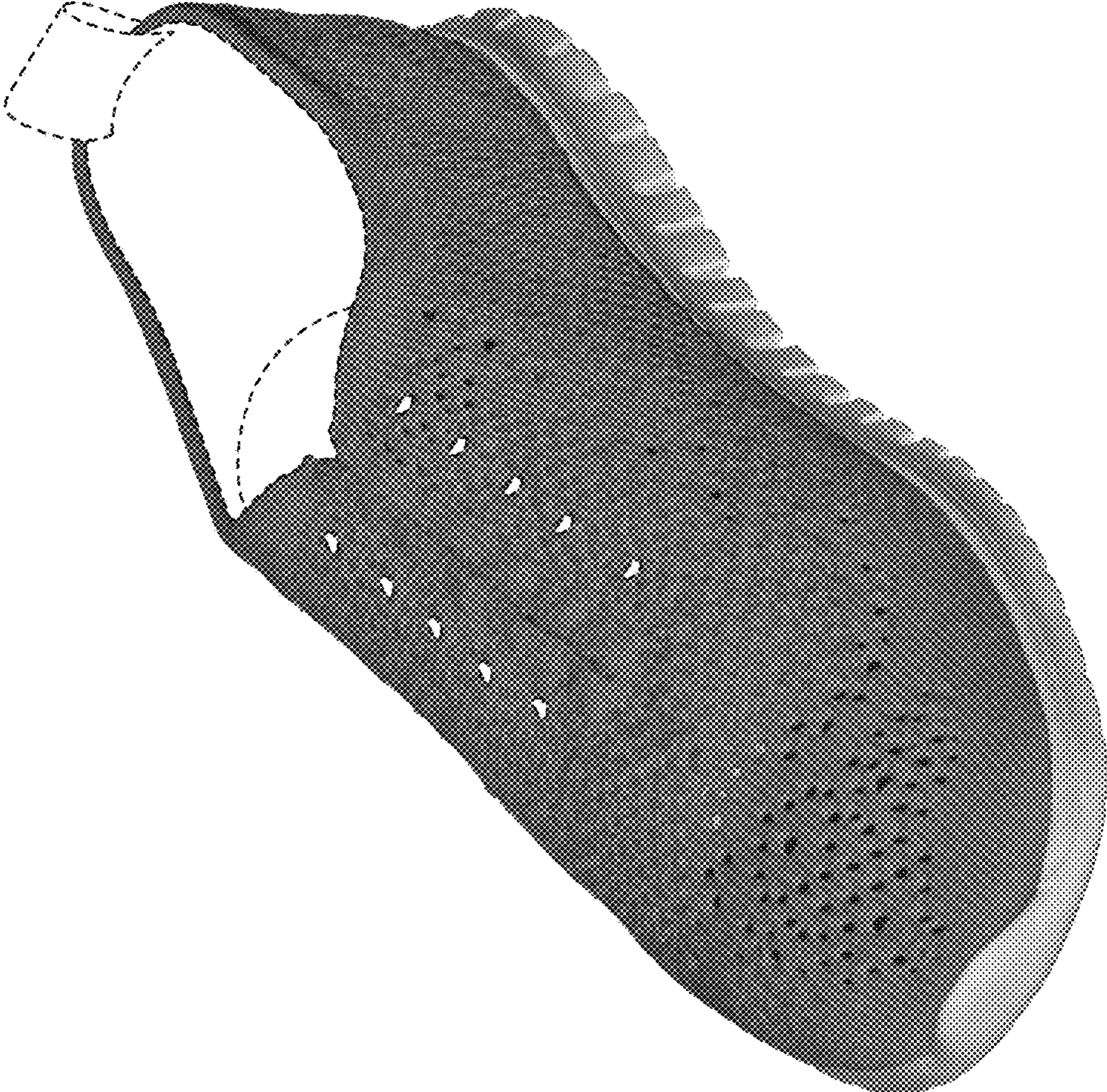

FIG. 1

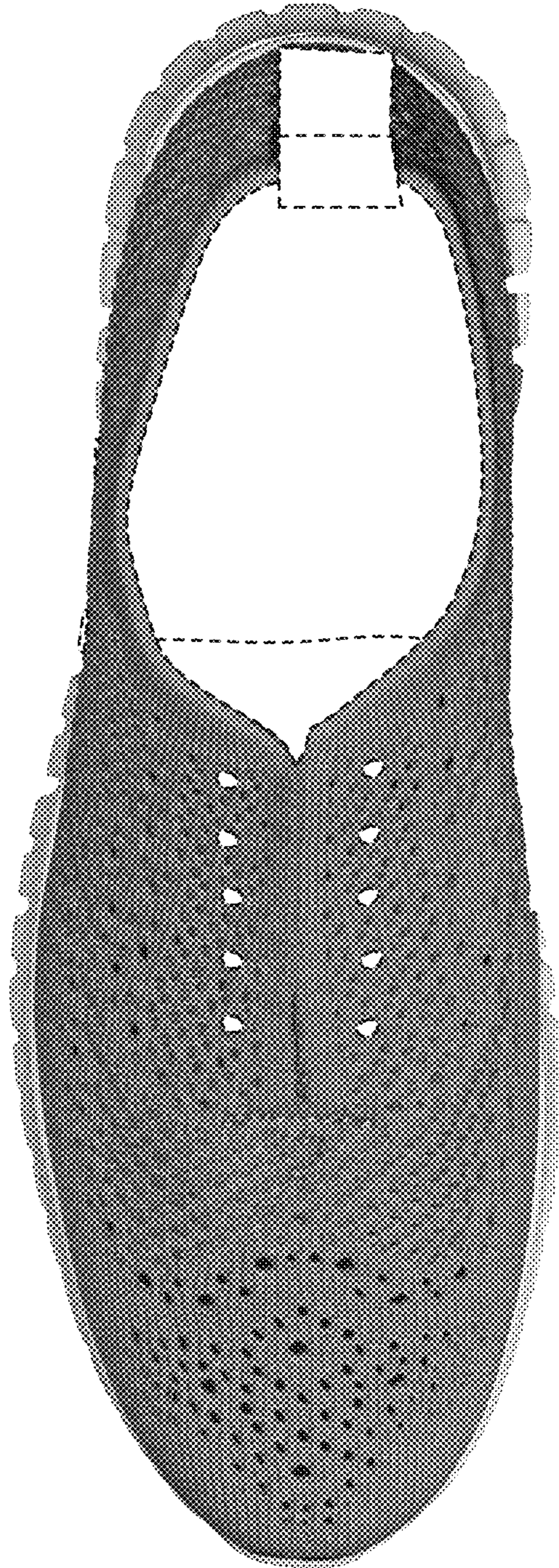

FIG. 2

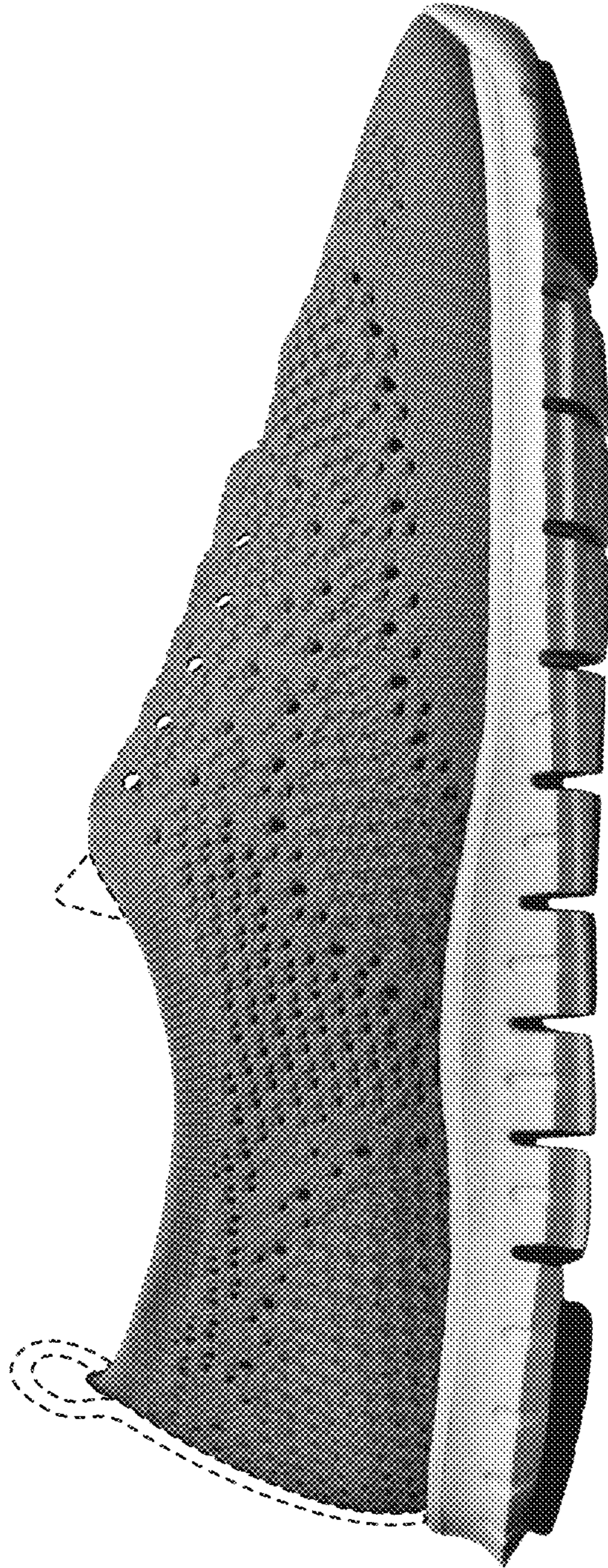

FIG. 3

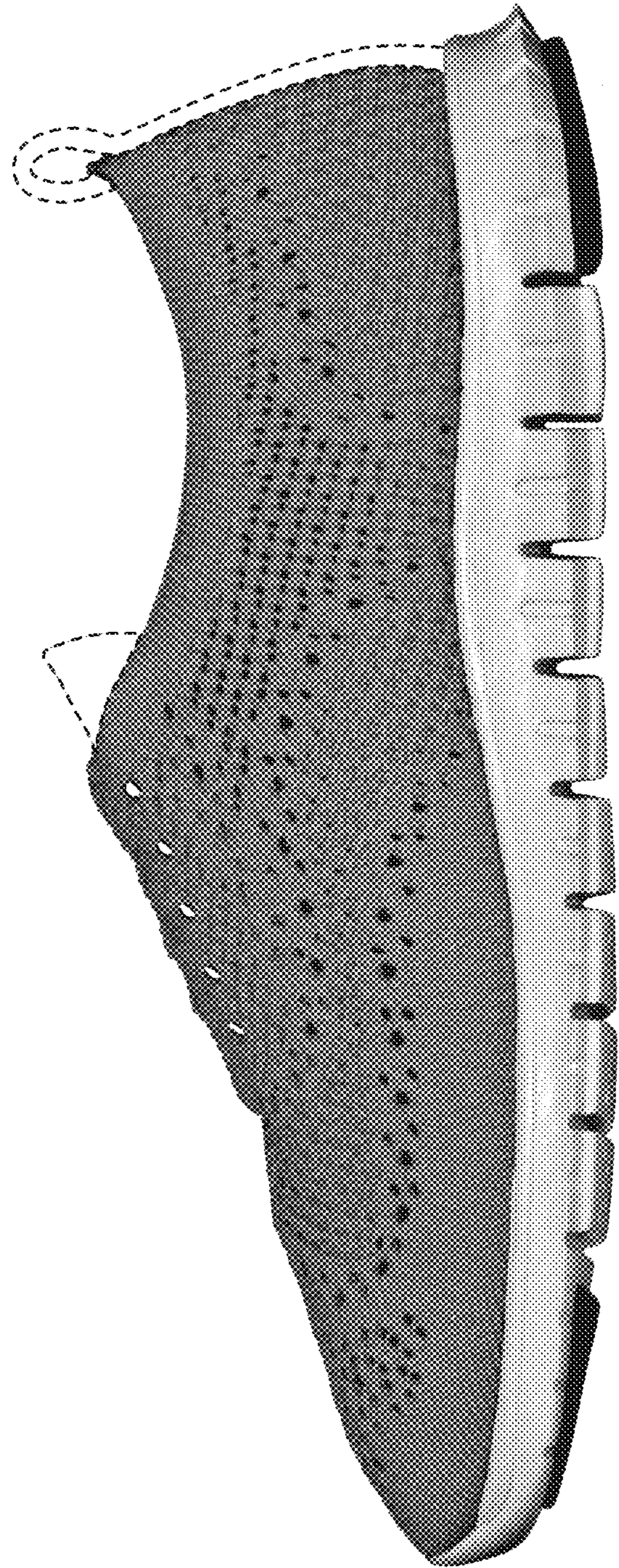

FIG. 4

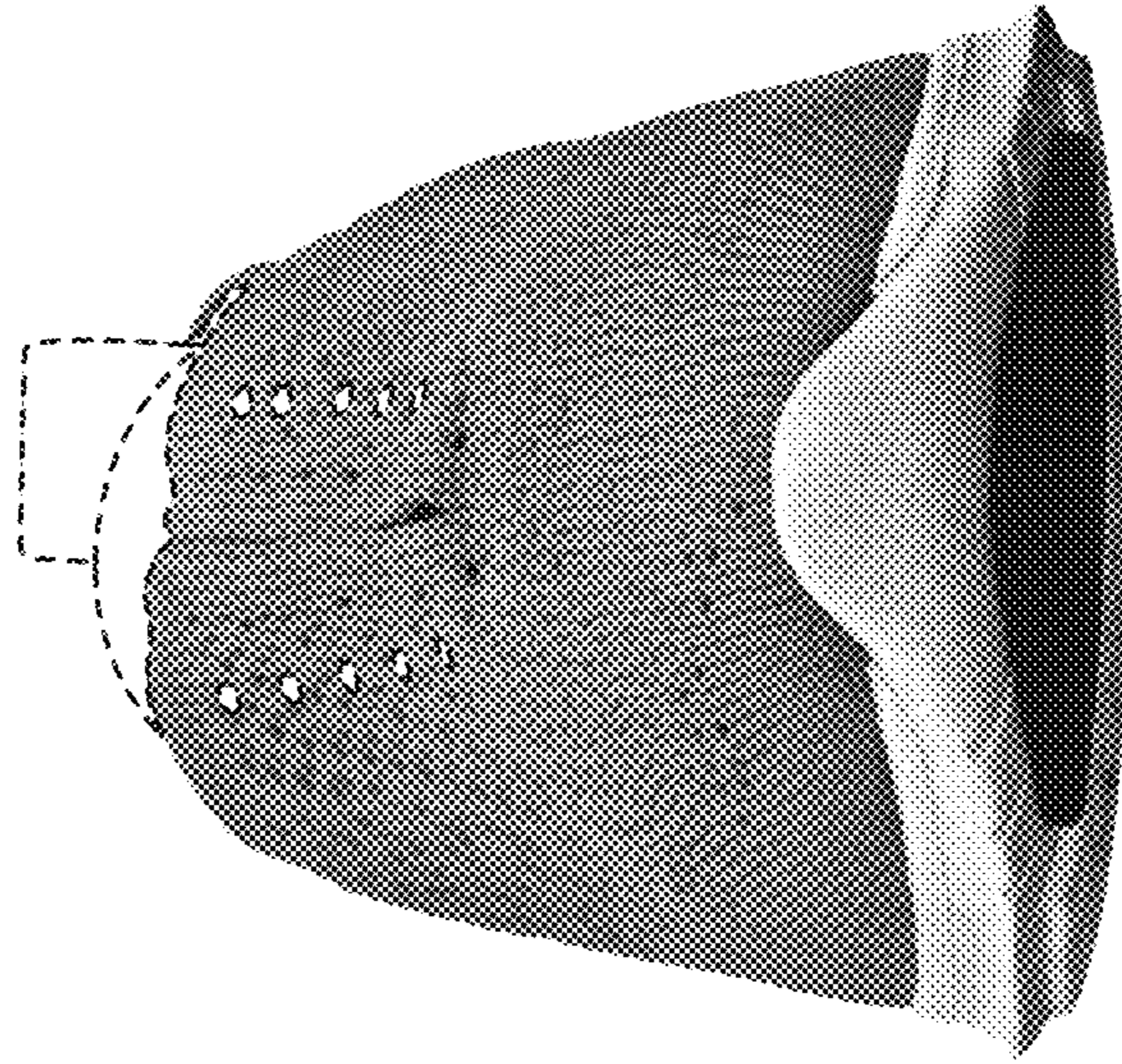

FIG. 5

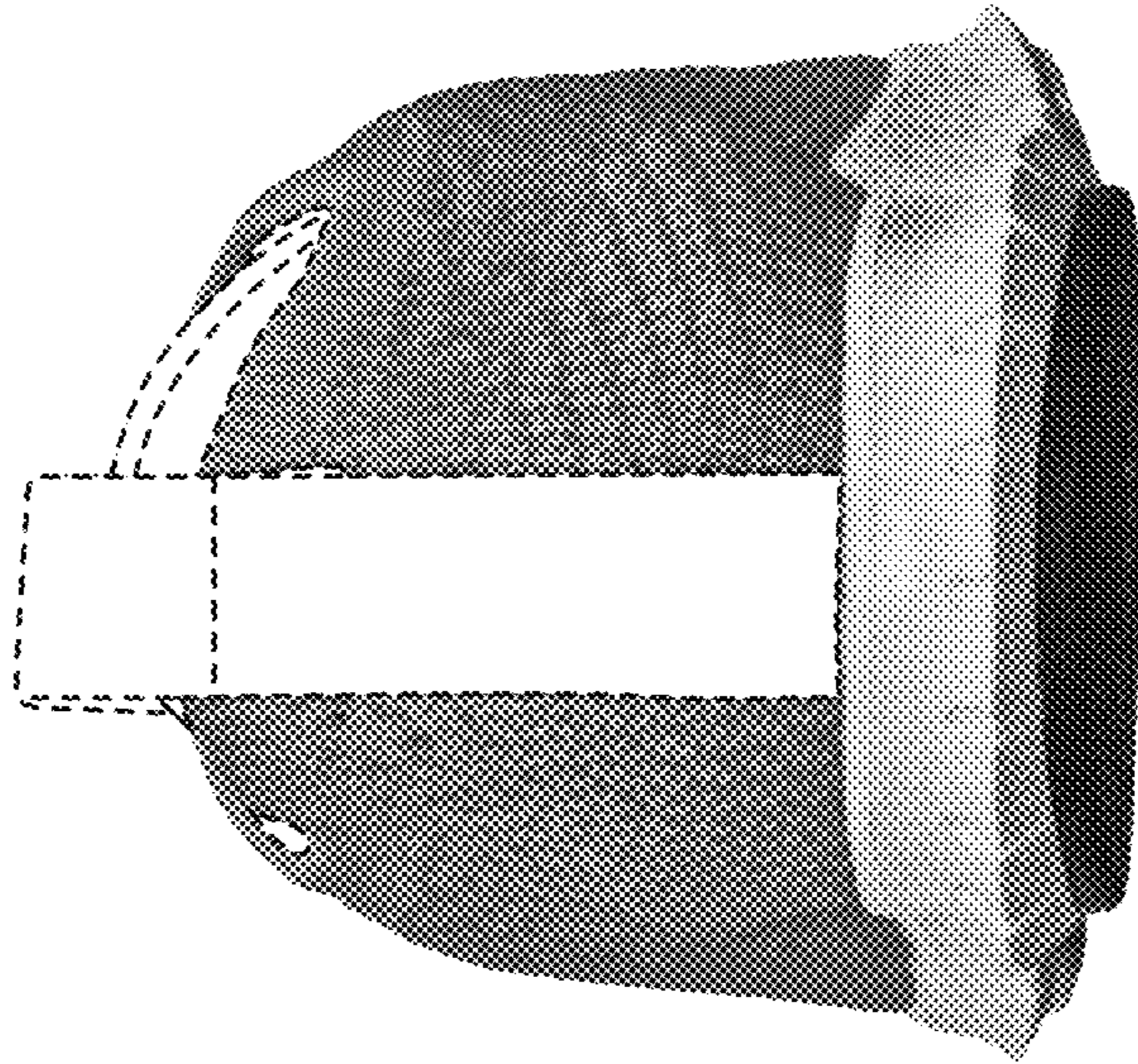

FIG. 6



UNITED STATES PATENT AND TRADEMARK OFFICE  
**CERTIFICATE OF CORRECTION**

PATENT NO. : D817,609 S  
APPLICATION NO. : 29/570512  
DATED : May 15, 2018  
INVENTOR(S) : Jack Boys et al.

Page 1 of 8

It is certified that error appears in the above-identified patent and that said Letters Patent is hereby corrected as shown below:

On the Title Page

Below Abstract, replace "1 Claim, 6 Drawing Sheets" with --1 Claim, 7 Drawing Sheets--.

In the Drawings

Delete Drawing Sheets 1-6 and replace with the attached Drawing Sheets 1-7. FIG. 7 has been added.

Signed and Sealed this  
Third Day of September, 2019

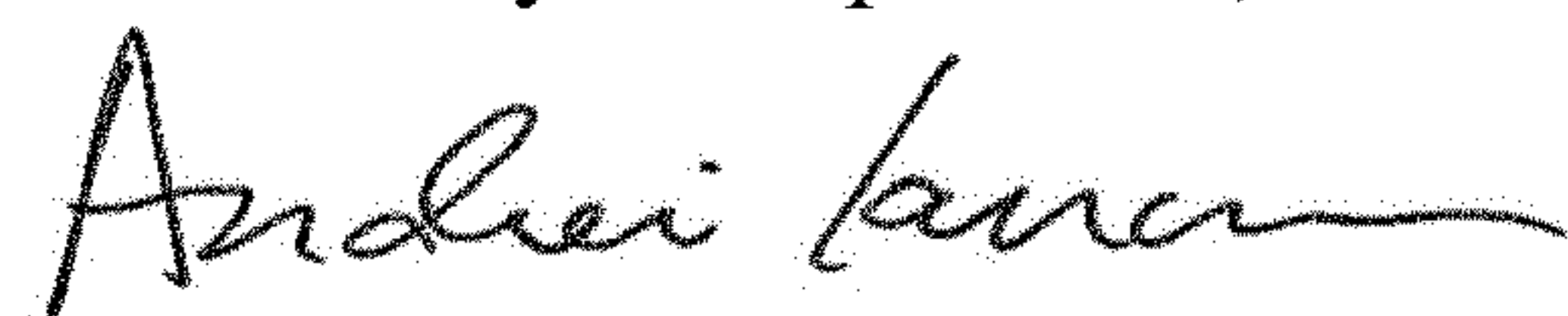

Andrei Iancu  
*Director of the United States Patent and Trademark Office*

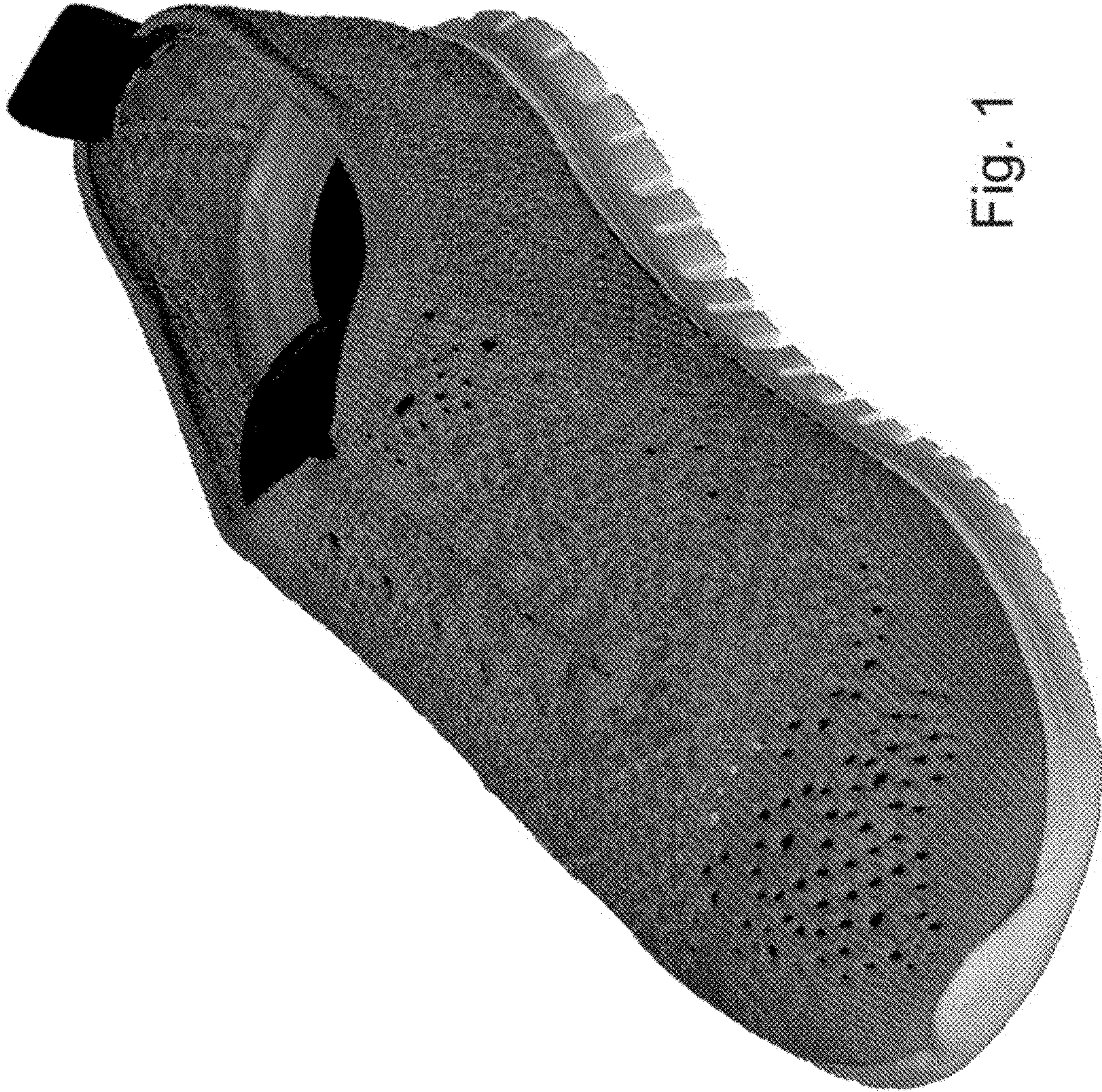

Fig. 1

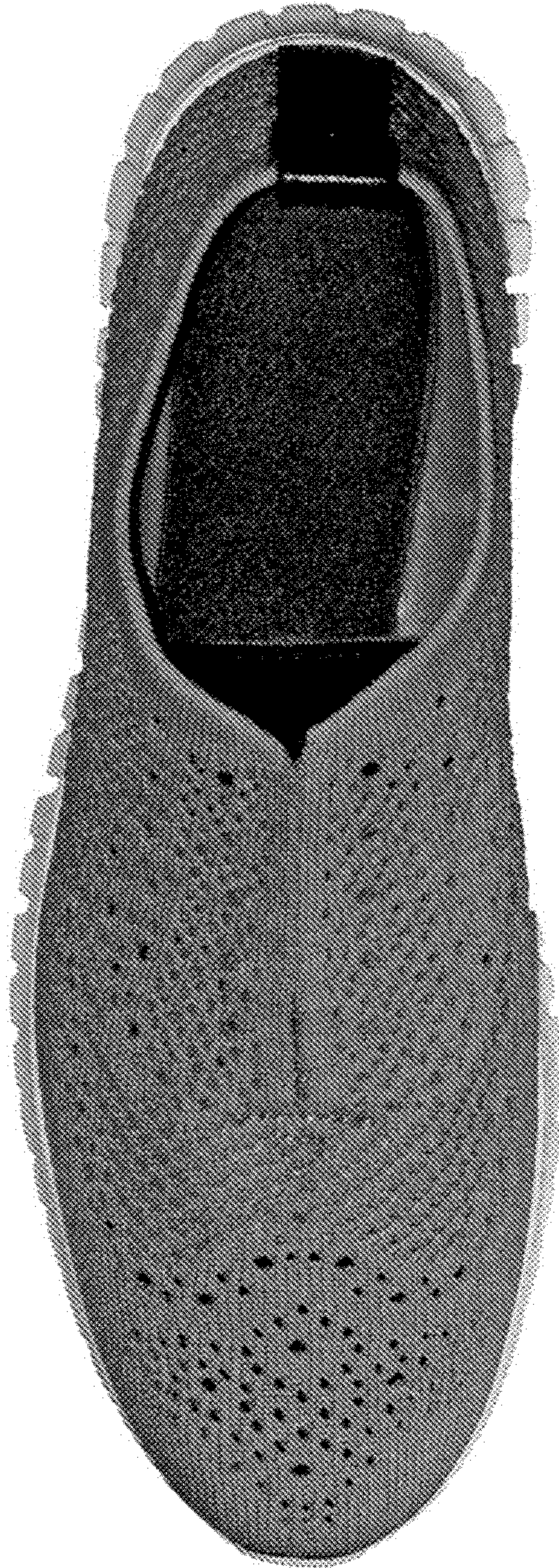

Fig. 2

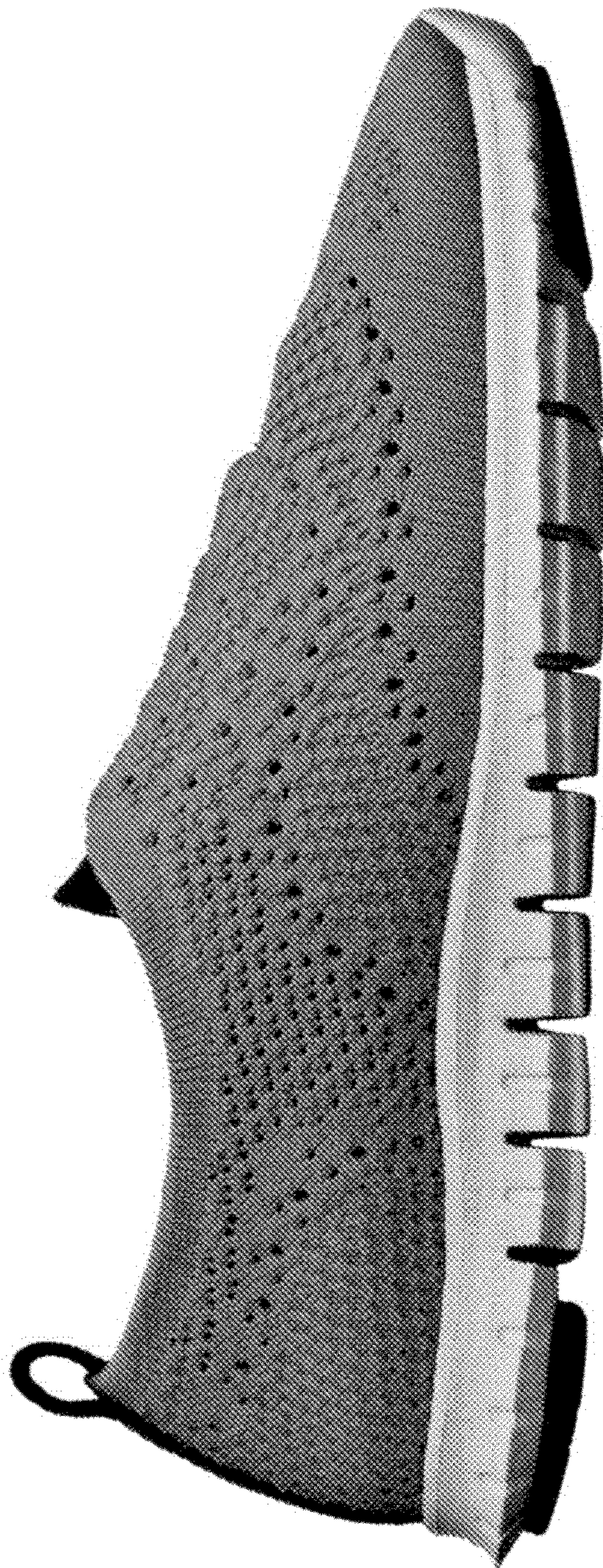

Fig. 3

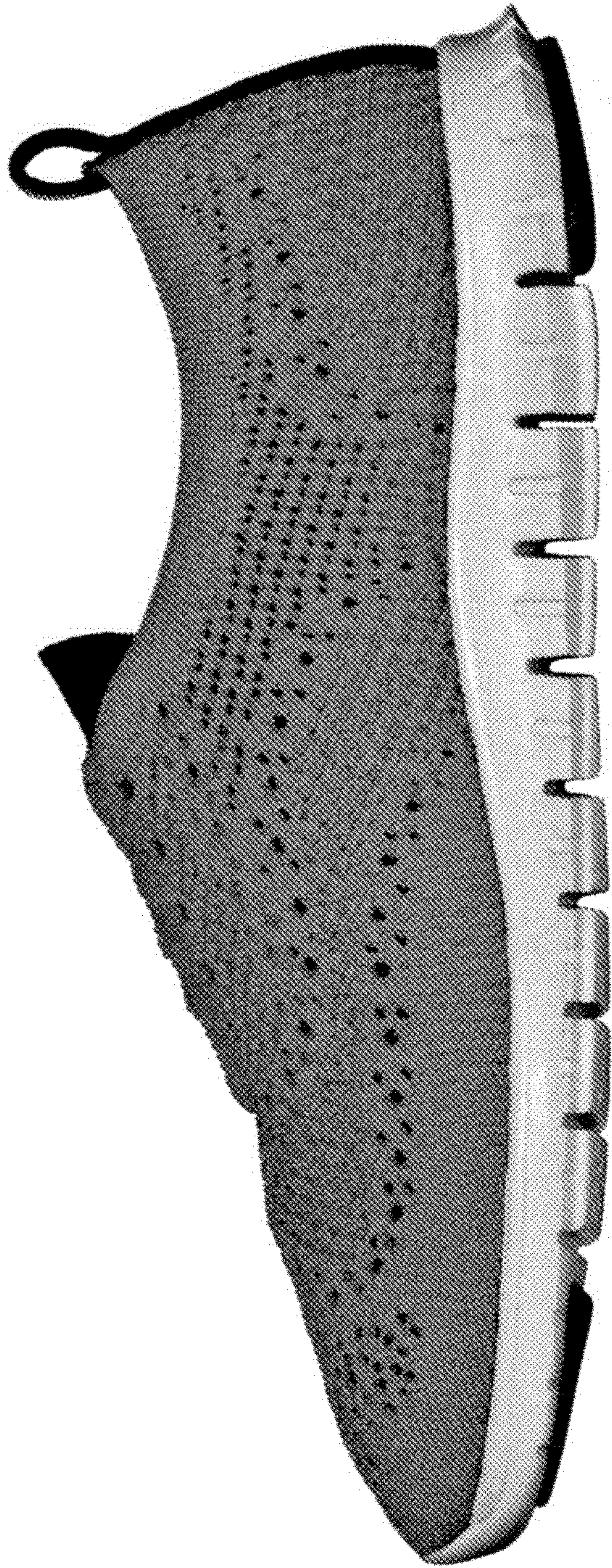

Fig. 4

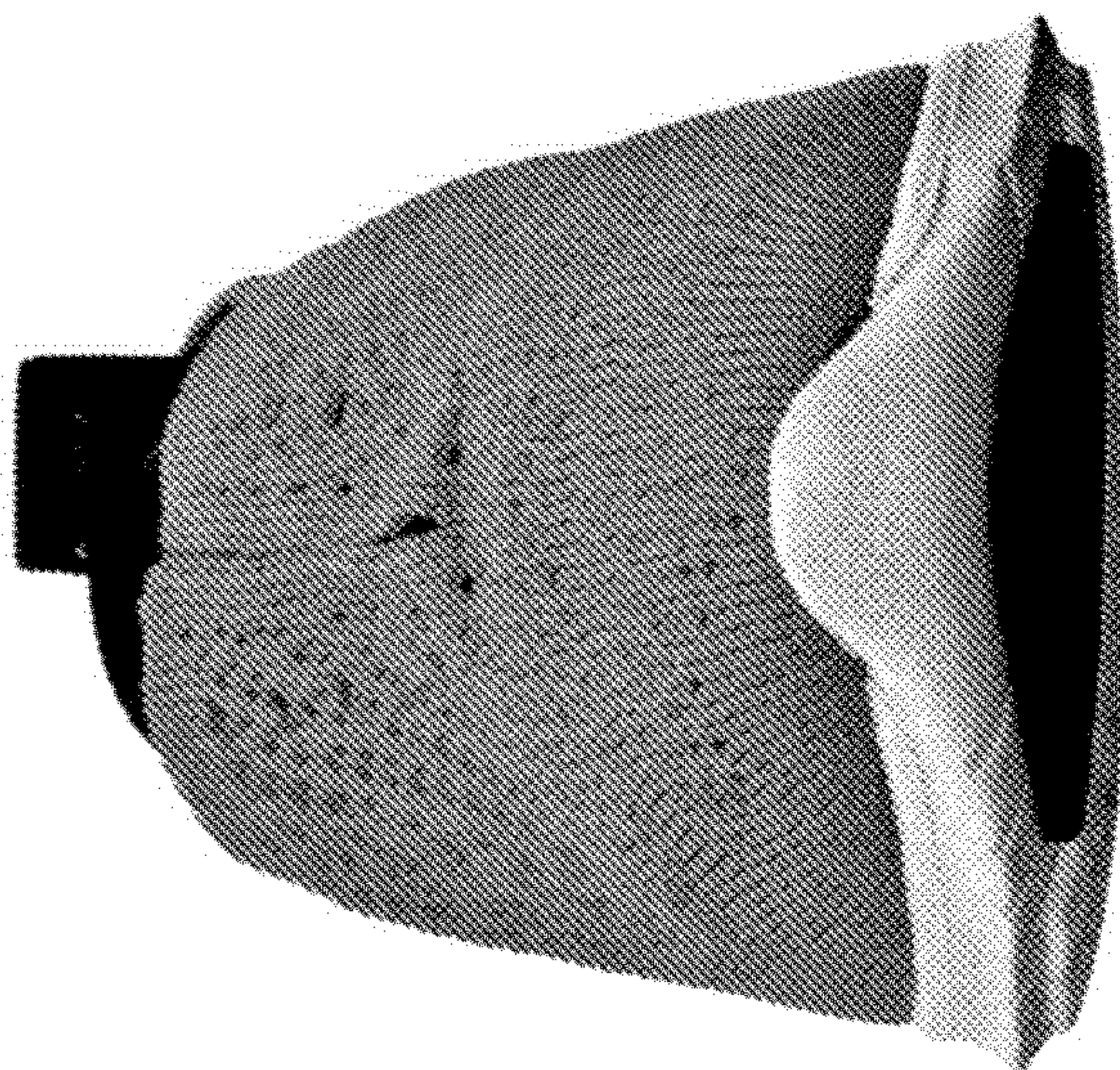

Fig. 5

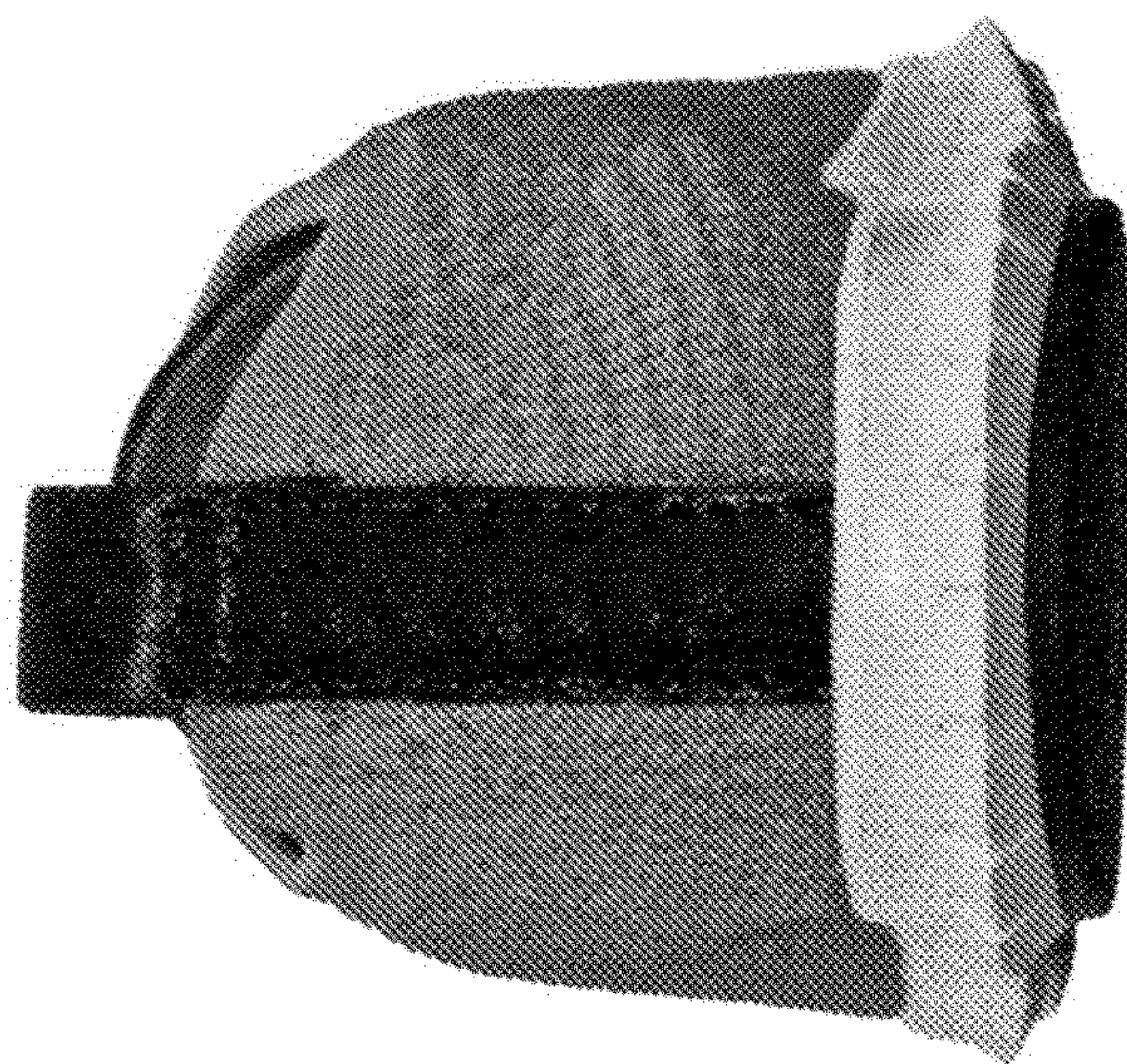

Fig. 6

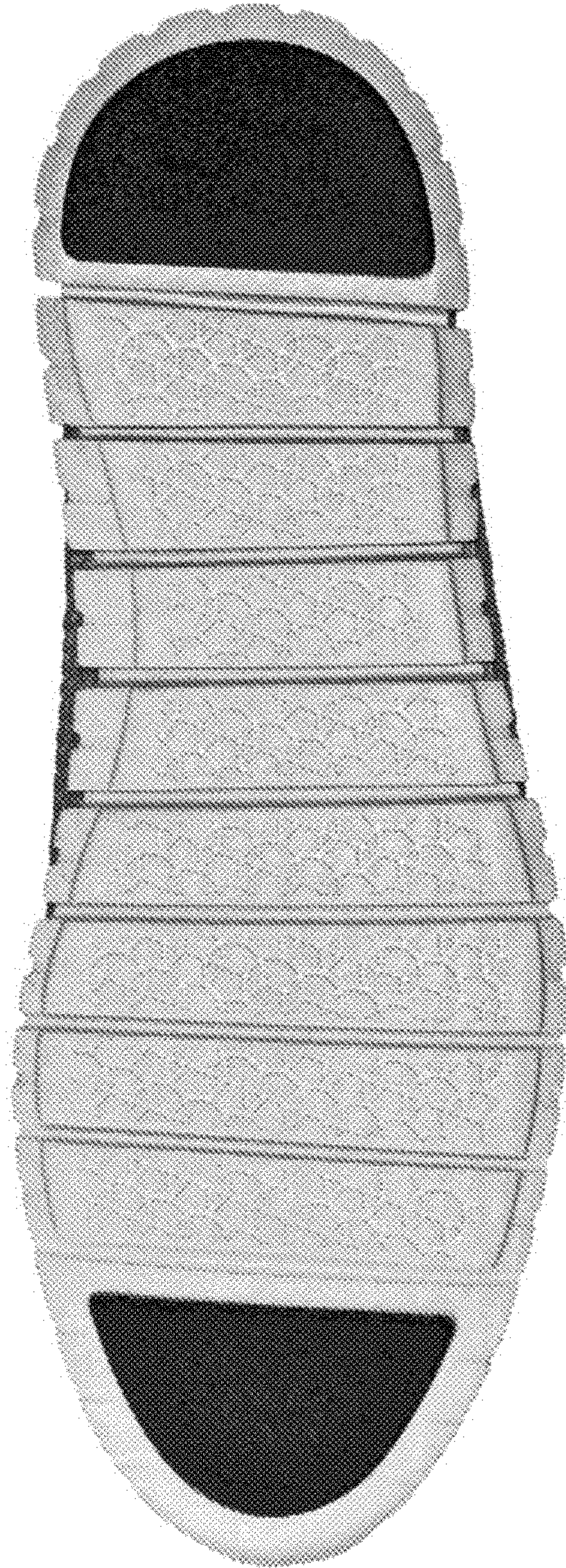

Fig. 7



UNITED STATES PATENT AND TRADEMARK OFFICE  
**CERTIFICATE OF CORRECTION**

PATENT NO. : D817,609 S  
APPLICATION NO. : 29/570512  
DATED : May 15, 2018  
INVENTOR(S) : Boys et al.

Page 1 of 10

It is certified that error appears in the above-identified patent and that said Letters Patent is hereby corrected as shown below:

Delete Des. Patent No. D817,609 S in its entirety and replace with attached Des. Patent No. D817,609 S in its entirety.

This certificate supersedes the Certificate of Correction issued September 3, 2019.

Signed and Sealed this  
Twelfth Day of May, 2020

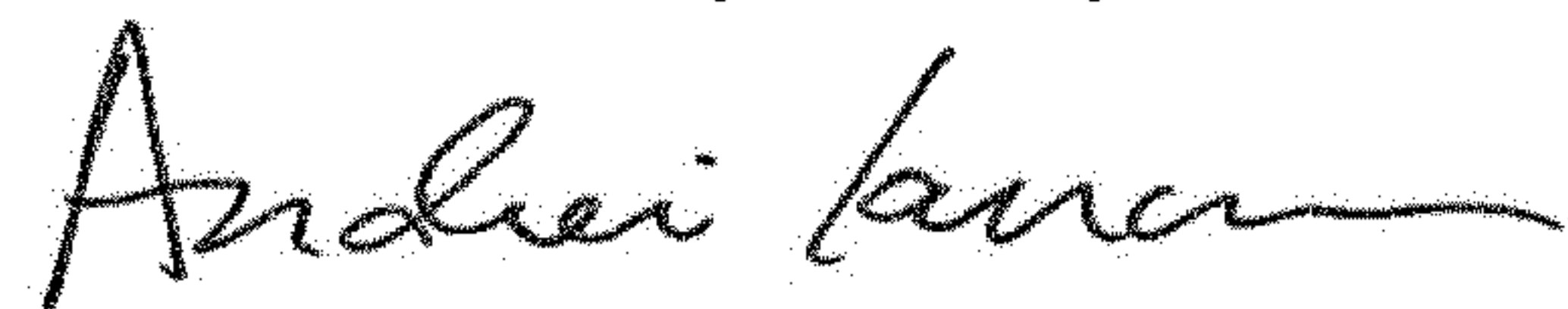

Andrei Iancu  
*Director of the United States Patent and Trademark Office*

(12) **United States Design Patent** (10) **Patent No.:** **US D817,609 S**  
**Boys et al.** (45) **Date of Patent:** **\*\* May 15, 2018**

(54) **SHOE**  
 (71) Applicant: **Cole Haan LLC, New York, NY (US)**  
 (72) Inventors: **Jack Boys, New York, NY (US); Ann Bono, New York, NY (US); Aubert Shepherd, Greenland, NH (US); Mattias Verfl, Brooklyn, NY (US)**  
 (73) Assignee: **COLE HAAN LLC, New York, NY (US)**

3,968,293 A \* 7/1976 Cunningham ..... B29C 67/202  
 264/41  
 D309,370 S \* 7/1990 Nagai ..... D2/953  
 D487,336 S 3/2004 Matis  
 D525,775 S 8/2006 Cintron  
 D541,521 S 5/2007 Smith et al.  
 D595,938 S \* 7/2009 Fuchs ..... D2/907  
 D598,190 S 8/2009 Weber  
 D635,748 S \* 4/2011 Katz ..... D2/902  
 D663,519 S 7/2012 Grangaard  
 D707,022 S \* 6/2014 Della Valle ..... D2/944

(Continued)

(\*\*) Term: **15 Years**

(21) Appl. No.: **29/570,512**

(22) Filed: **Jul. 8, 2016**

(51) **LOC (12) Cl.** ..... **02-04**

(52) **U.S. Cl.**  
 USPC ..... **D2/945; D2/908**

(58) **Field of Classification Search**  
 USPC ..... D2/896, 897, 900, 902, 907, 908, 909,  
 D2/912, 919, 920, 923, 929, 942, 943,  
 D2/944, 945, 946, 951, 953, 955, 960,  
 D2/969, 972, 974, 976  
 CPC ..... A43B 1/04; A43B 5/06; A43B 5/10; A43B  
 23/24

See application file for complete search history.

(56) **References Cited**

**U.S. PATENT DOCUMENTS**

D73,396 S \* 9/1927 Bates ..... D2/944  
 D90,234 S 7/1933 Daniels  
 D96,687 S 8/1935 Lutz  
 2,014,094 A \* 9/1935 Wiggin ..... A43B 3/14  
 36/11  
 D108,128 S \* 1/1938 Pick ..... D2/974  
 D108,334 S 2/1938 Lutz  
 D119,276 S 3/1940 Lutz  
 D130,845 S 12/1941 Pick  
 D158,953 S \* 6/1950 Gillis ..... D2/907

**OTHER PUBLICATIONS**

"Introducing the Innovative Cole Haan Zerøgrand Stitchlite Oxford," as posted on KicksOnFire.com, posted Feb. 2, 2017, [site visited Jun. 22, 2017]. Available on the Internet, <URL:https://www.kicksonfire.com/cole-haan-zero-grand-stitchlite/>.

(Continued)

*Primary Examiner* — Celia Murphy  
*Assistant Examiner* — Clare Ann Gannon  
 (74) *Attorney, Agent, or Firm* — Thompson Coburn LLP

(57) **CLAIM**

The ornamental design for a shoe, as shown and described.

**DESCRIPTION**

FIG. 1 is a perspective view of a shoe showing our new design;  
 FIG. 2 is a top plan view thereof;  
 FIG. 3 is a lateral side view thereof;  
 FIG. 4 is a medial side view thereof;  
 FIG. 5 is a front view thereof;  
 FIG. 6 is a rear view thereof; and,  
 FIG. 7 is a bottom plan view thereof.  
 The broken lines depicting the tongue, heel pull-strap, eyelets, and inside surfaces of the shoe form no part of the claimed design.

**1 Claim, 7 Drawing Sheets**

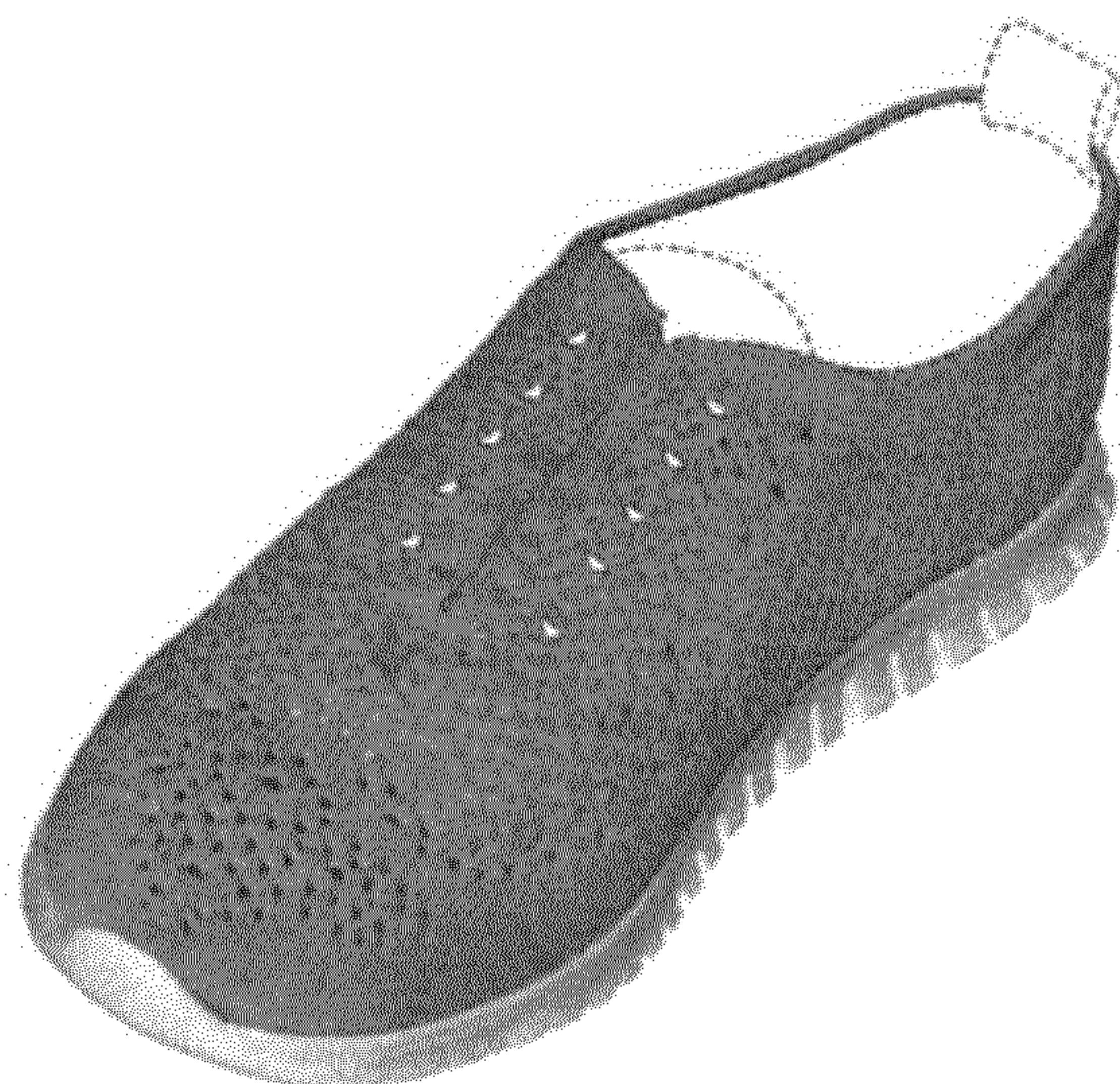

US D817,609 S

Page 2

(56)

References Cited

U.S. PATENT DOCUMENTS

D707,943 S	7/2014	Nascimento	
D722,225 S	2/2015	Williams, Jr.	
D723,772 S *	3/2015	Miner	D2/947
D728,205 S *	5/2015	Weddle	D2/906
D730,035 S *	5/2015	Henderson	D2/947
D748,386 S *	2/2016	Henderson	D2/947
D752,329 S	3/2016	Kirschner	
D759,365 S	6/2016	Henderson et al.	
D767,268 S *	9/2016	Avar	D2/974
D772,553 S	11/2016	Williams, Jr.	
D774,287 S *	12/2016	Taestensen	D2/908

D779,184 S	2/2017	Avar et al.	
D783,975 S *	4/2017	Schenone	D2/902
D787,170 S	5/2017	Mokos et al.	
D793,044 S *	8/2017	Mokos	D2/944

OTHER PUBLICATIONS

Cole Haan, Women's Zerogrand Stitchlite Wingtip Oxford—Ironstone Knit—Tropical Peach, as posted at ShopSpring.com <<http://ShopSpring.com>> [online], posting date not available. [site visited Jun. 23, 2017]. Available on the Internet, <URL: <<https://www.shopspring.com/products/53199277>>>.

\* cited by examiner

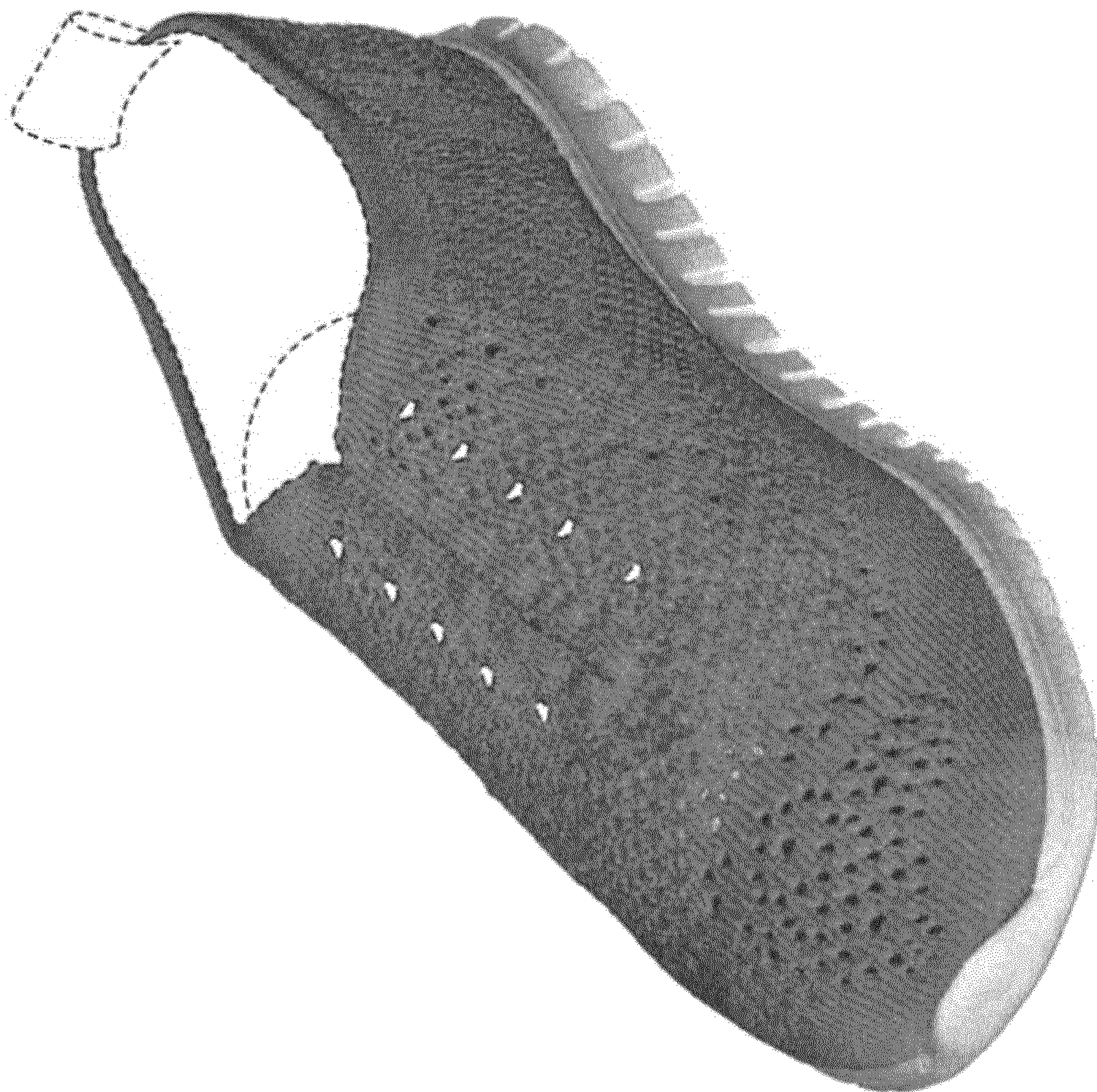

FIG. 1

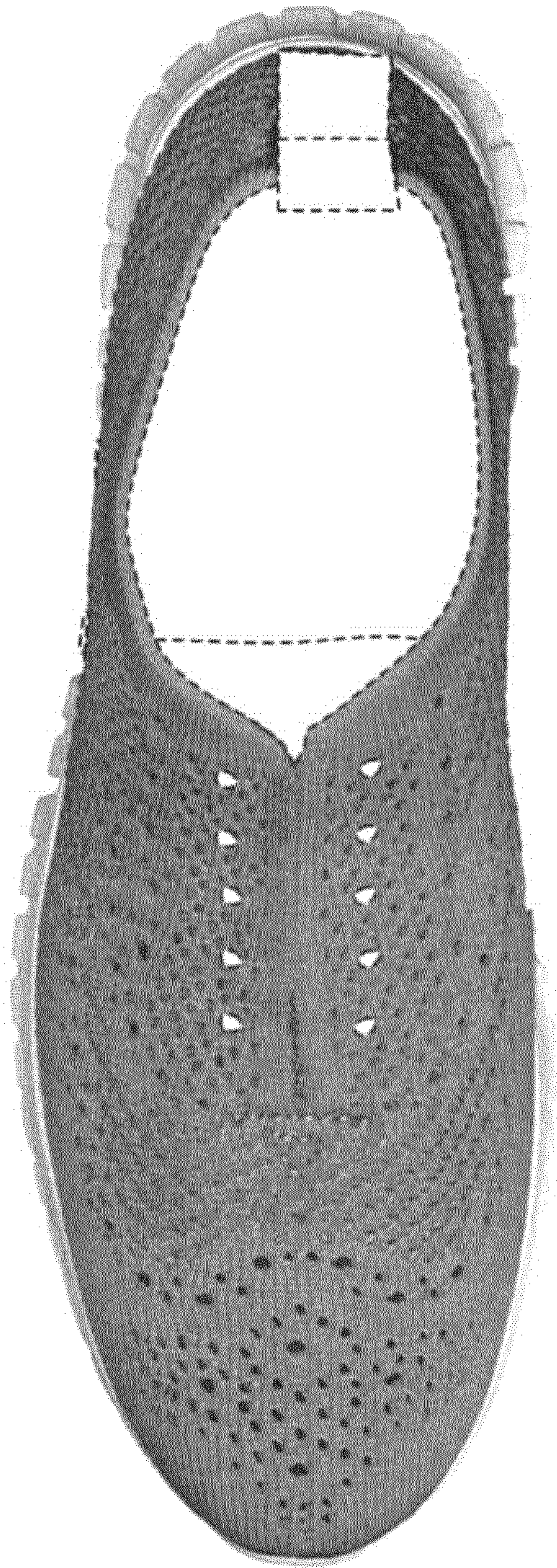

FIG. 2

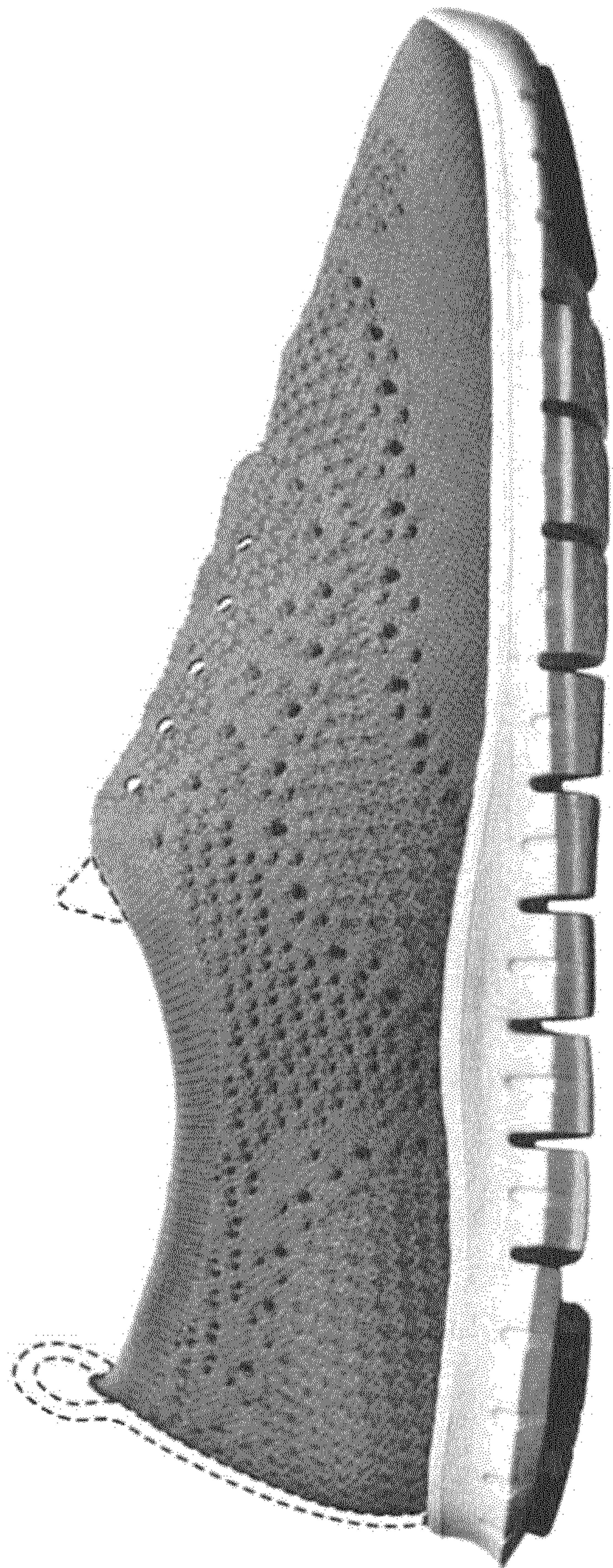

FIG. 3

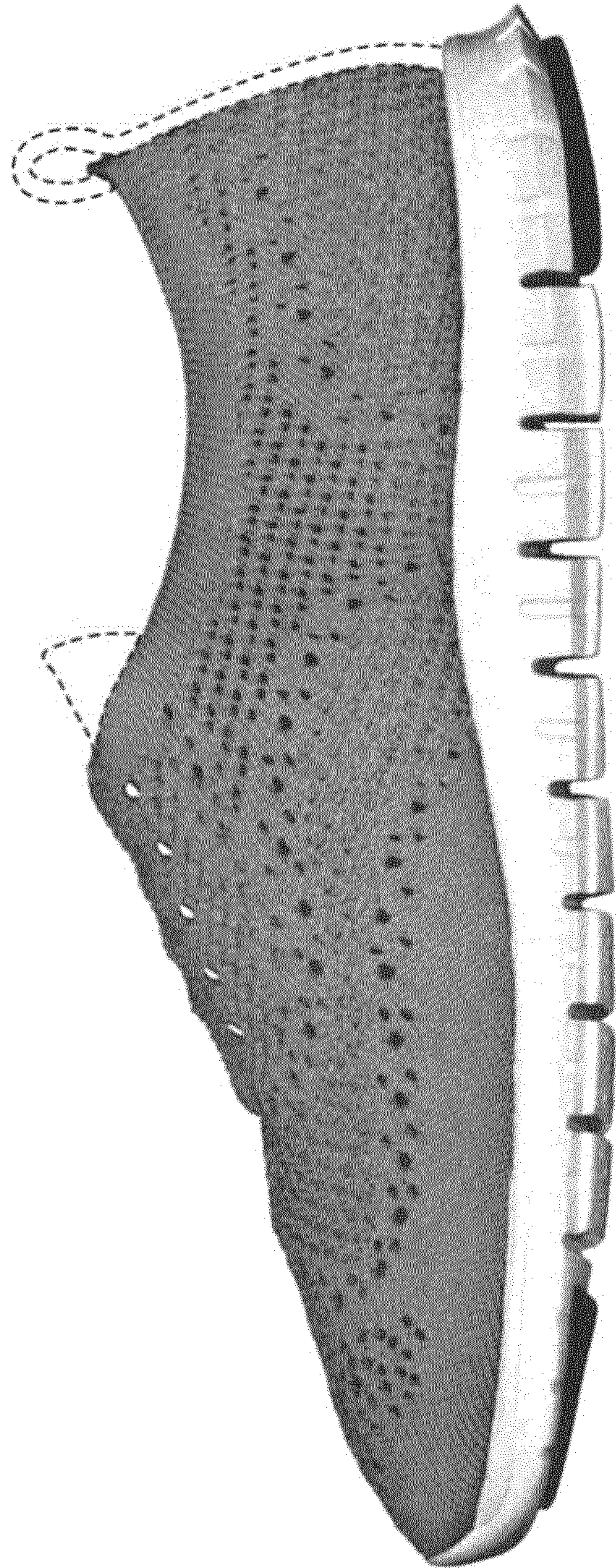

FIG. 4

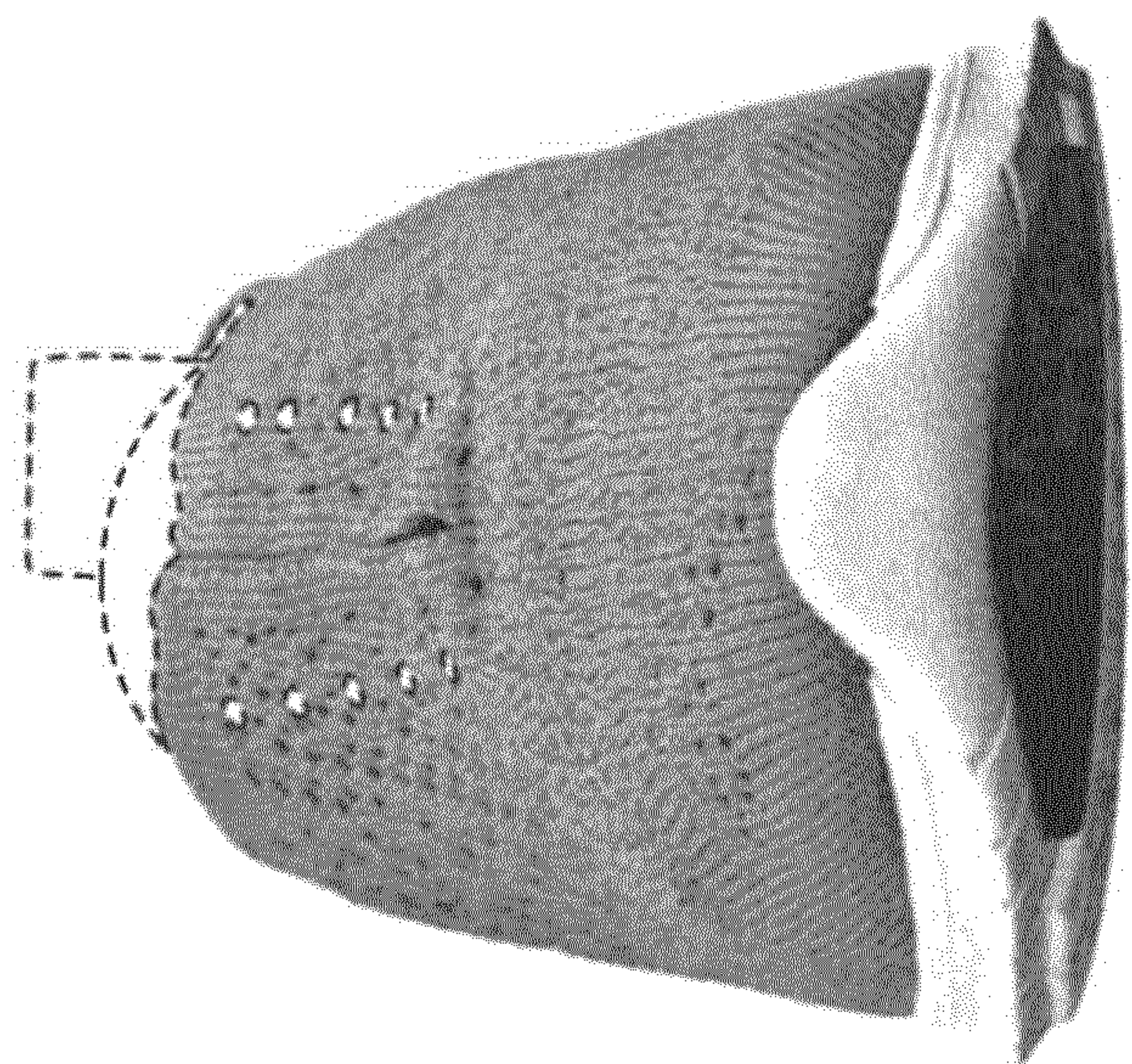

FIG. 5



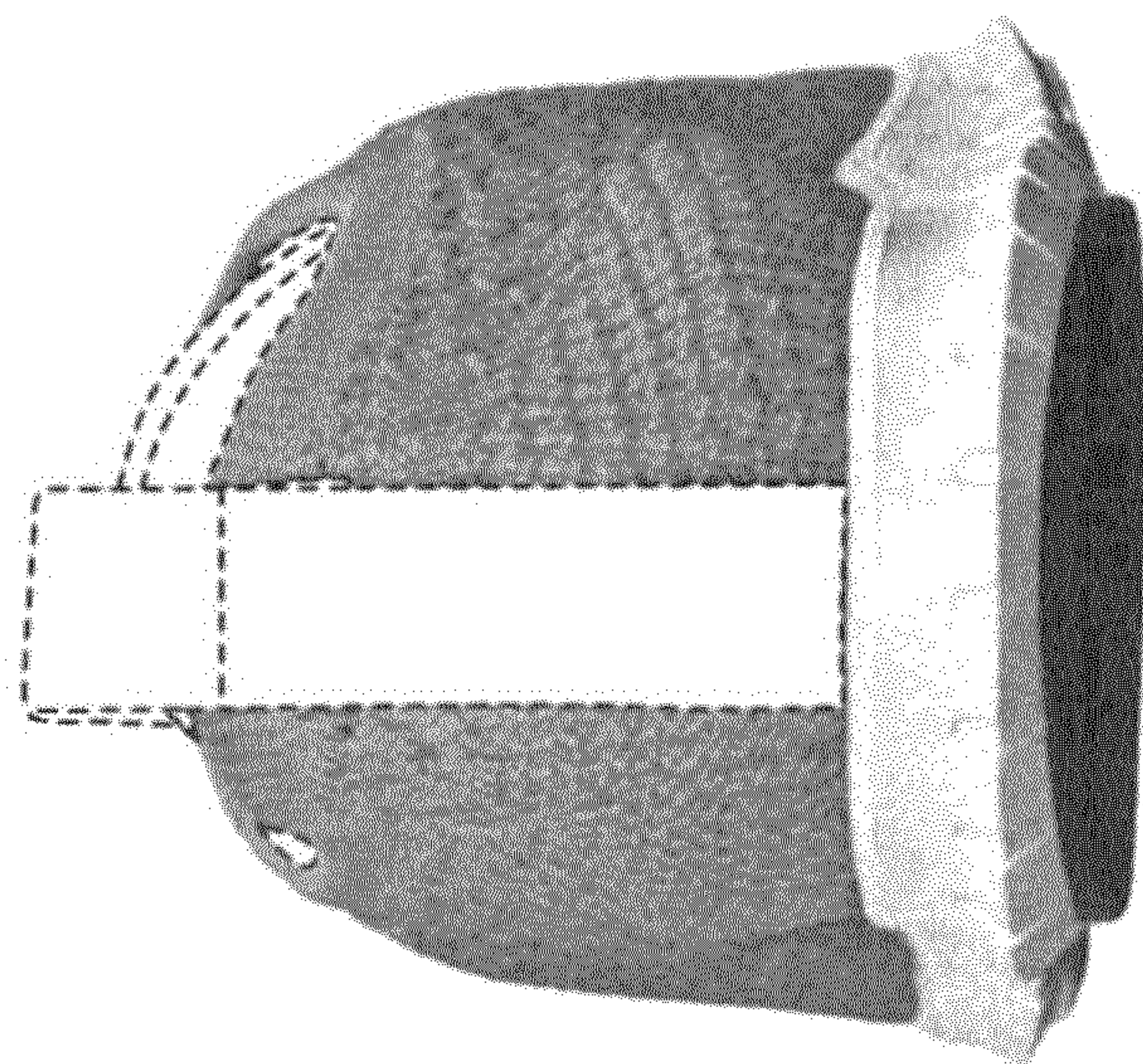

FIG. 6

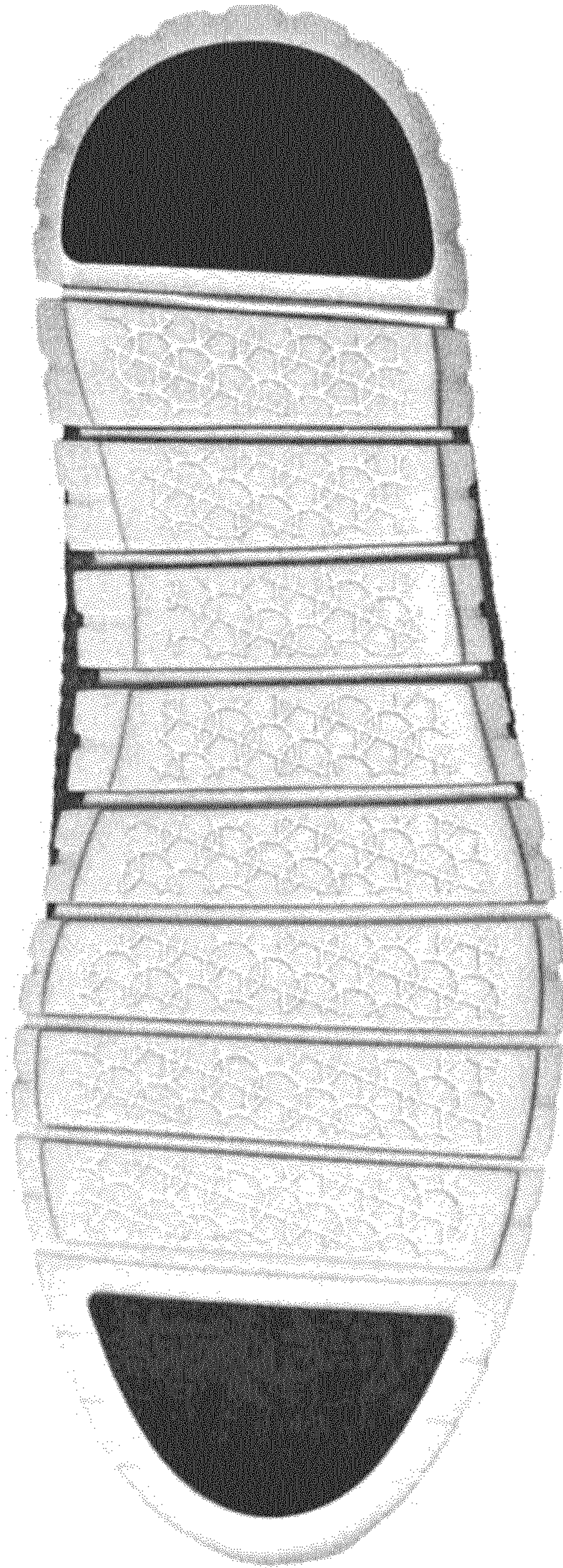

Fig. 7