



US00D817592S

(12) **United States Design Patent** (10) **Patent No.:** **US D817,592 S**
Pandolfino (45) **Date of Patent:** **** May 15, 2018**

(54) **NECKWEAR**

(74) *Attorney, Agent, or Firm* — Sughrue Mion, PLLC

(71) Applicant: **PATUGA LLC**, Clarence, NY (US)

(57) **CLAIM**

(72) Inventor: **Joseph Pandolfino**, Clarence, NY (US)

The ornamental design for neckwear, as shown and described.

(73) Assignee: **PATUGA LLC**, Clarence, NY (US)

(**) Term: **15 Years**

DESCRIPTION

(21) Appl. No.: **29/592,384**

(22) Filed: **Jan. 30, 2017**

(51) **LOC (11) Cl.** **02-05**

(52) **U.S. Cl.**
USPC **D2/605**

(58) **Field of Classification Search**
USPC D2/600, 601, 602, 603, 604, 605, 606,
D2/607, 608, 609, 627, 633, 637;
D8/323, 325, 327, 328; D11/3, 12, 19
(Continued)

FIG. 1 is a front elevation view of a first embodiment of a neckwear of my new design;
FIG. 2 is a rear elevation view thereof;
FIG. 3 is a right side elevation view thereof;
FIG. 4 is a left side elevation view thereof;
FIG. 5 is a top plan view thereof;
FIG. 6 is a bottom plan view thereof;
FIG. 7 is a front, right-sided perspective view thereof;
FIG. 8 is a rear, left-sided perspective view thereof;
FIG. 9 is a front elevation view of a second embodiment of a neckwear of my new design;
FIG. 10 is a rear elevation view thereof;
FIG. 11 is a right side elevation view thereof;
FIG. 12 is a left side elevation view thereof;
FIG. 13 is a top plan view thereof;
FIG. 14 is a bottom plan view thereof;
FIG. 15 is a front, right-sided perspective view thereof;
FIG. 16 is a rear, left-sided perspective view thereof;
FIG. 17 is a front elevation view of a third embodiment of a neckwear of my new design;
FIG. 18 is a rear elevation view thereof;
FIG. 19 is a right side elevation view thereof;
FIG. 20 is a left side elevation view thereof;
FIG. 21 is a top plan view thereof;
FIG. 22 is a bottom plan view thereof;
FIG. 23 is a front, right-sided perspective view thereof;
FIG. 24 is a rear, left-sided perspective view thereof;
FIG. 25 is a front elevation view of a fourth embodiment of a neckwear of my new design;
FIG. 26 is a rear elevation view thereof;
FIG. 27 is a right side elevation view thereof;
FIG. 28 is a left side view elevation thereof;
FIG. 29 is a top plan view thereof;
FIG. 30 is a bottom plan view thereof;

(56) **References Cited**

U.S. PATENT DOCUMENTS

D33,222 S * 9/1900 Spencer D8/327
1,626,139 A * 4/1927 Kraysler A44C 5/02
16/229

(Continued)

FOREIGN PATENT DOCUMENTS

AT 389630 B 1/1990
CN 2888922 Y 4/2007
WO 88/06414 A1 9/1988

OTHER PUBLICATIONS

Wood Ties, [on-line video]; [video posted to the Internet on Oct. 11, 2011]; [retrieved from the Internet on May 15, 2017]; URL: <https://www.youtube.com/watch?v=WRt7Gm_gUvU>. (2 pages).*

(Continued)

Primary Examiner — Karen E Eldridge Powers

Assistant Examiner — Jasmine Mlinarcik

(Continued)

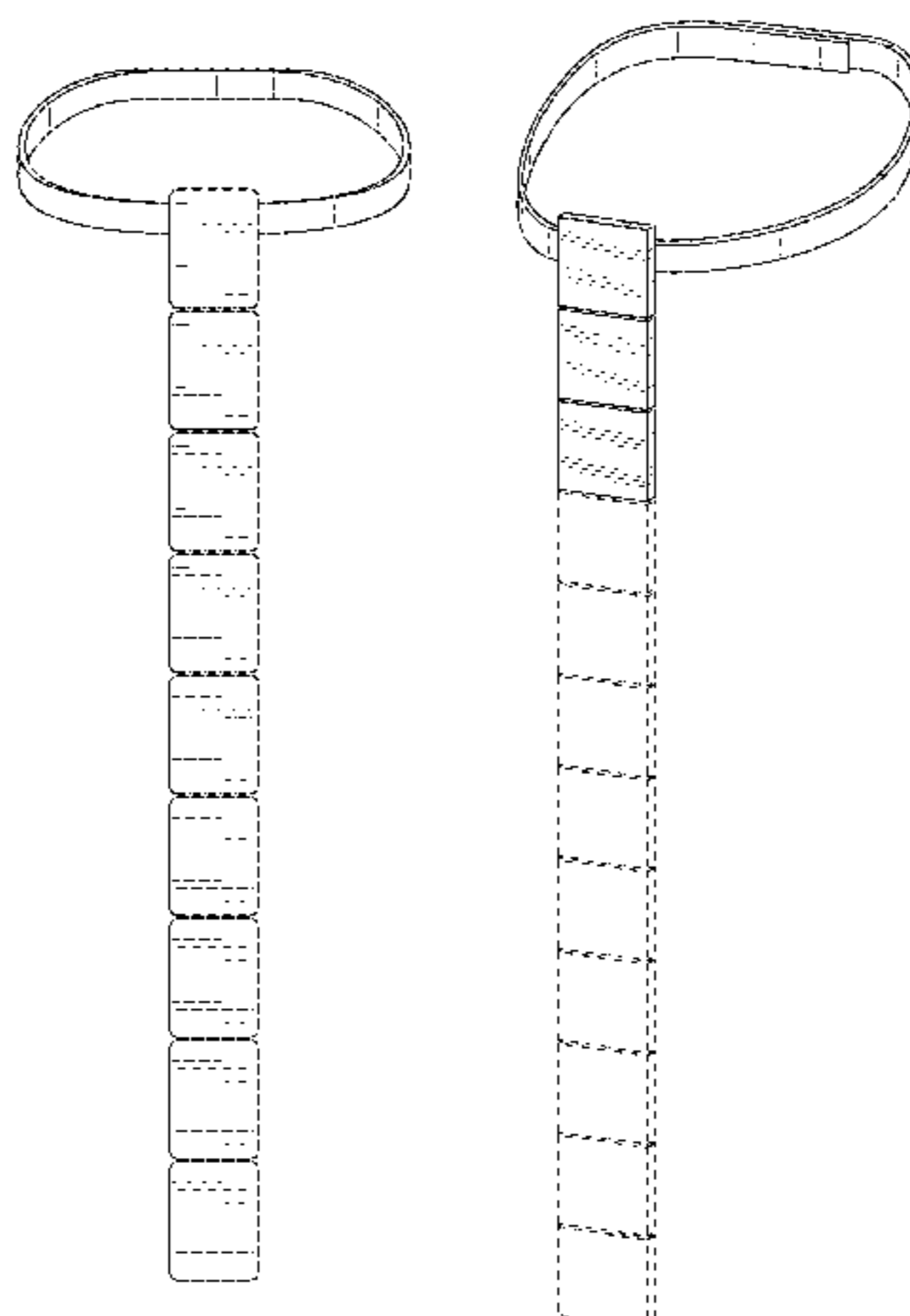

FIG. 31 is a front, right-sided perspective view thereof;
 FIG. 32 is a rear, left-sided perspective view thereof;
 FIG. 33 is a front elevation view of a fifth embodiment of a neckwear of my new design;
 FIG. 34 is a rear elevation view thereof;
 FIG. 35 is a right side elevation view thereof;
 FIG. 36 is a left side elevation view thereof;
 FIG. 37 is a top plan view thereof;
 FIG. 38 is a bottom plan view thereof;
 FIG. 39 is a front, right-sided perspective view thereof;
 FIG. 40 is a rear, left-sided perspective view thereof;
 FIG. 41 is a front elevation view of a sixth embodiment of a neckwear of my new design;
 FIG. 42 is a rear elevation view thereof;
 FIG. 43 is a right side elevation view thereof;
 FIG. 44 is a left side elevation view thereof;
 FIG. 45 is a top plan view thereof;
 FIG. 46 is a bottom plan view thereof;
 FIG. 47 is a front, right-sided perspective view thereof;
 FIG. 48 is a rear, left-sided perspective view thereof;
 FIG. 49 is a front elevation view of a seventh embodiment of a neckwear of my new design;
 FIG. 50 is a rear elevation view thereof;
 FIG. 51 is a right side elevation view thereof;
 FIG. 52 is a left side elevation view thereof;
 FIG. 53 is a top plan view thereof;
 FIG. 54 is a bottom plan view thereof;
 FIG. 55 is a front, right-sided perspective view thereof;
 FIG. 56 is a rear, left-sided perspective view thereof;
 FIG. 57 is a front elevation view of an eight embodiment of a neckwear of my new design;
 FIG. 58 is a rear elevation view thereof;
 FIG. 59 is a right side elevation view thereof;
 FIG. 60 is a left side elevation view thereof;
 FIG. 61 is a top plan view thereof;
 FIG. 62 is a bottom plan view thereof;
 FIG. 63 is a front, right-sided perspective view thereof; and,
 FIG. 64 is a rear, left-sided perspective view thereof.
 The features shown in broken lines illustrate environmental structure that forms no part of the claimed design.

1 Claim, 32 Drawing Sheets

(58) **Field of Classification Search**

CPC A41D 23/00; A41D 25/00; A41D 25/003;
 A41D 25/005; A41D 25/006; A41D
 25/008; A41D 25/02; A41D 25/06
 See application file for complete search history.

(56) **References Cited**

U.S. PATENT DOCUMENTS

1,635,269 A * 7/1927 Grant A44C 5/105
 59/78
 D112,303 S 11/1938 Huddle
 D156,650 S * 12/1949 Woodrow et al. D11/12

D161,798 S * 1/1951 Spielmann D2/605
 D178,725 S * 9/1956 Flynn D2/637
 2,874,386 A * 2/1959 Loomis A41D 25/02
 2/150
 D230,540 S 3/1974 Gillman
 4,546,494 A 10/1985 Garber
 D285,314 S * 8/1986 Galoppo D19/157
 4,627,113 A 12/1986 Lord
 D294,658 S * 3/1988 Davenport, Sr. D2/633
 D301,520 S * 6/1989 Campbell D2/608
 D308,852 S * 6/1990 Wakamatsu D11/25
 5,016,285 A * 5/1991 Just A41D 25/00
 2/144
 D318,754 S 8/1991 Hughes
 5,036,550 A 8/1991 Wilsey
 D320,499 S 10/1991 White et al.
 D322,227 S * 12/1991 Warhol D10/32
 5,238,528 A * 8/1993 Heinrich A41D 25/00
 216/36
 D340,879 S * 11/1993 French D11/3
 D374,111 S 10/1996 Wilson
 D376,971 S * 12/1996 Schutz D8/327
 5,673,434 A 10/1997 Risk
 D398,435 S 9/1998 Gray
 D457,287 S * 5/2002 Geisen D2/608
 D553,134 S * 10/2007 Marne D14/448
 D605,376 S * 12/2009 Dickerson D2/605
 D623,827 S * 9/2010 Pauling D2/605
 D636,251 S * 4/2011 Herglotz D8/328
 D663,916 S 7/2012 Bracey
 D668,429 S * 10/2012 Ross D2/606
 D681,496 S * 5/2013 Goerges D11/26
 D710,181 S * 8/2014 Christensen D8/323
 D714,178 S * 9/2014 Sabbioni D11/3
 D726,525 S * 4/2015 Kenerly D8/328
 9,161,582 B2 10/2015 Anderson
 D746,718 S * 1/2016 Akana D11/3
 D748,370 S 2/2016 Johnson
 D775,777 S 1/2017 Peral
 D779,780 S * 2/2017 Bowers D2/605
 D802,251 S * 11/2017 Walker D2/605

OTHER PUBLICATIONS

Wooden Tie, [on-line]; [Wayback Machine crawl-back Internet posting date Oct. 19, 2011]; [retrieved from the Internet on May 15, 2017]; URL: <<https://web.archive.org/web/20111019082900/http://www.thegreenhead.com/2011/08/wooden-tie.php>>. (3 pages).*

How to Make a Wooden Necktie, [on-line]; [video posted to the Internet on Nov. 9, 2012]; [retrieved from the Internet on May 15, 2017]; URL: <<https://www.youtube.com/watch?v=V800RKmEaWs>>. (4 pages).*

Engineering Corner, <https://www.shapeways.com/product/MUT37CQWA/articulated-necktie-clips-on-to-your-top-button>; author and publication date unknown.

The fusionguy, <https://thefusionguy.wordpress.com/category/wood-working/>; author and publication date unknown.

<http://woodknot.com/>; author and publication date unknown.

<http://www.jebiga.com/cams-wooden-ties-new-take-fashion/>; author and publication date unknown.

<https://www.vat19.com/item/wood-tie>; author and publication date unknown.

* cited by examiner

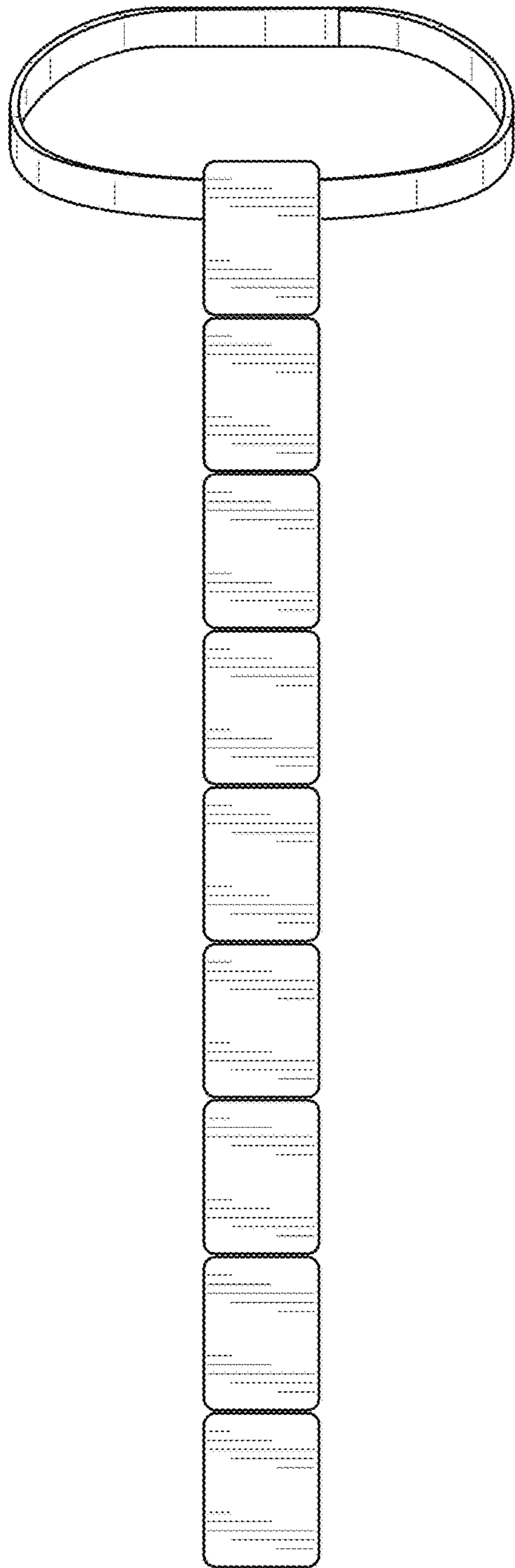

FIG. 1

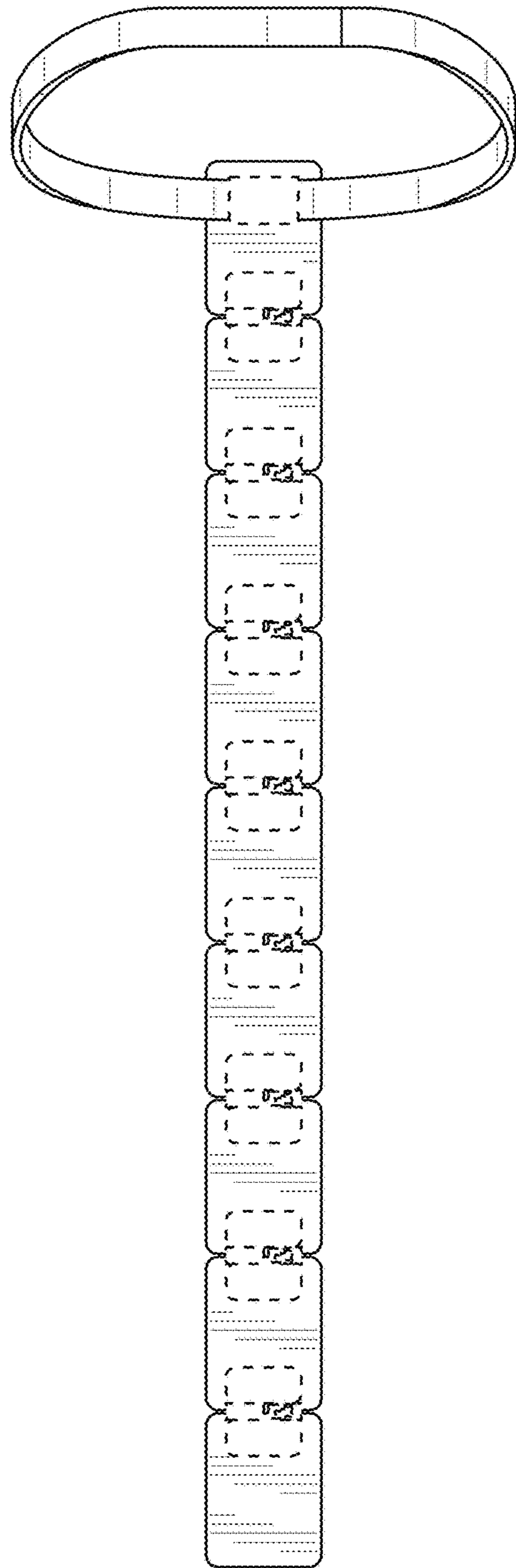

FIG. 2

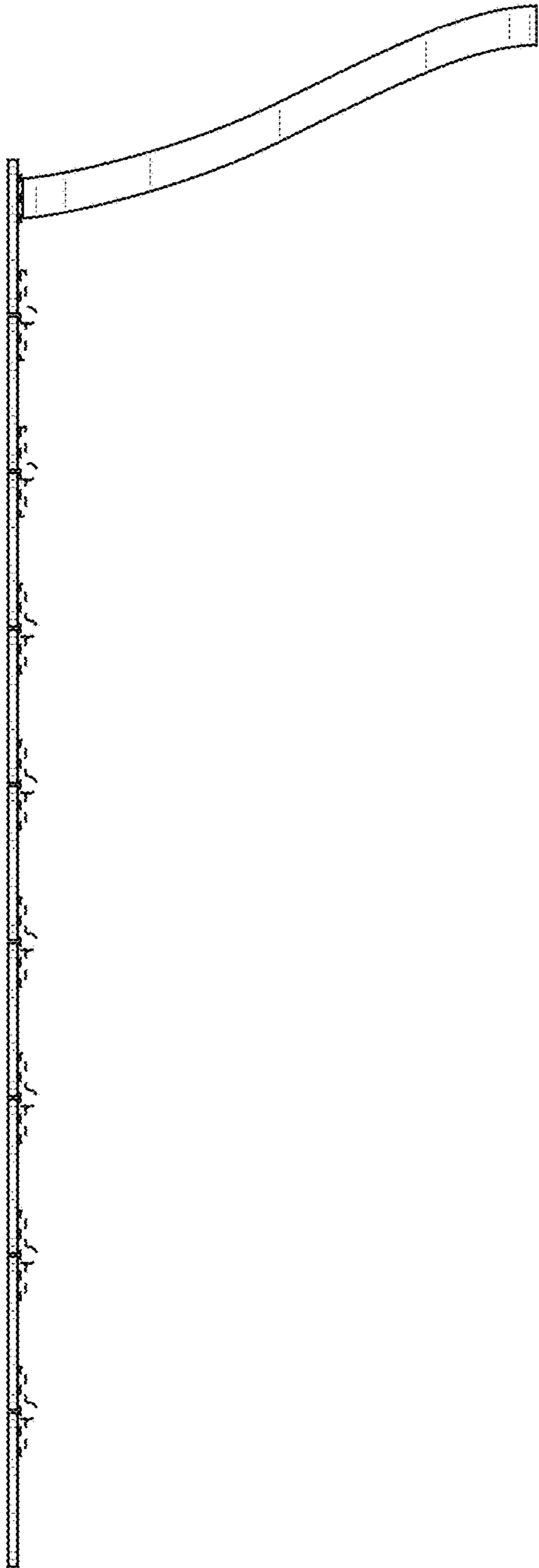

FIG. 3

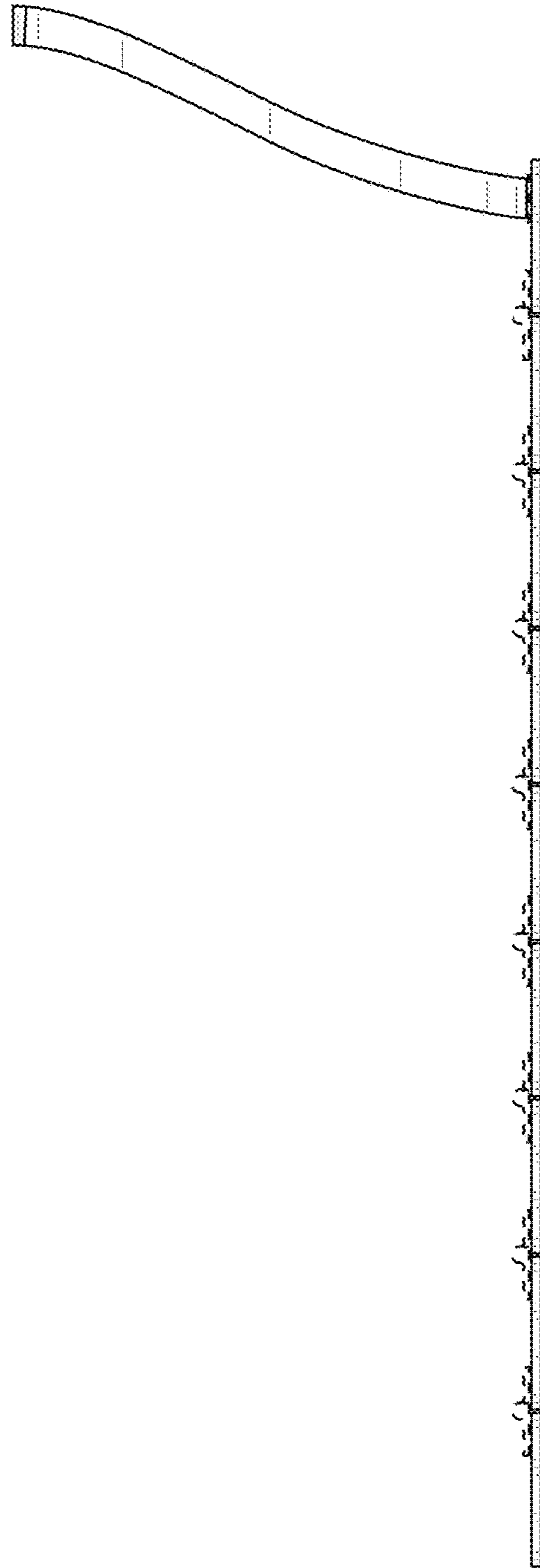

FIG. 4

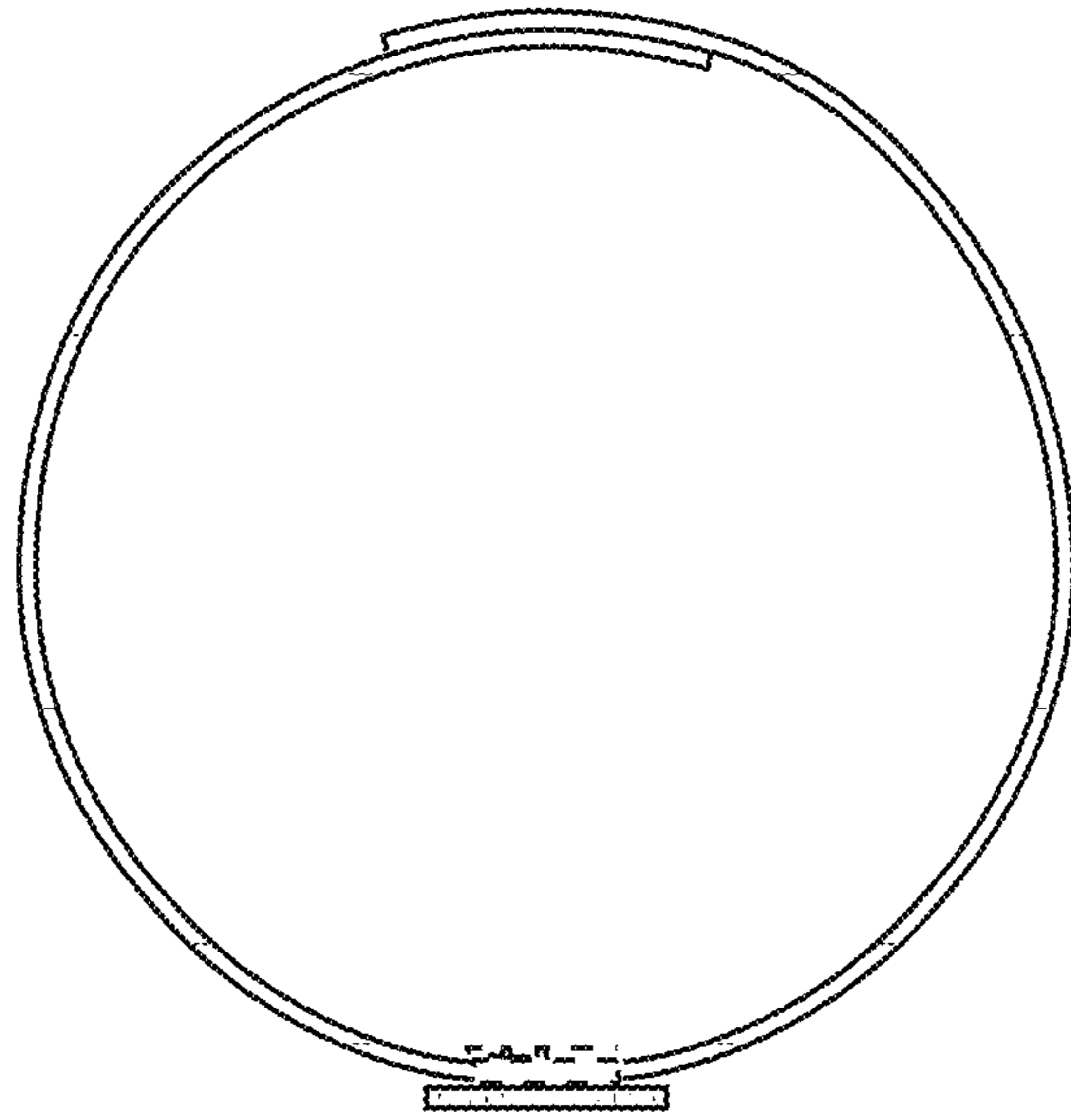

FIG. 5

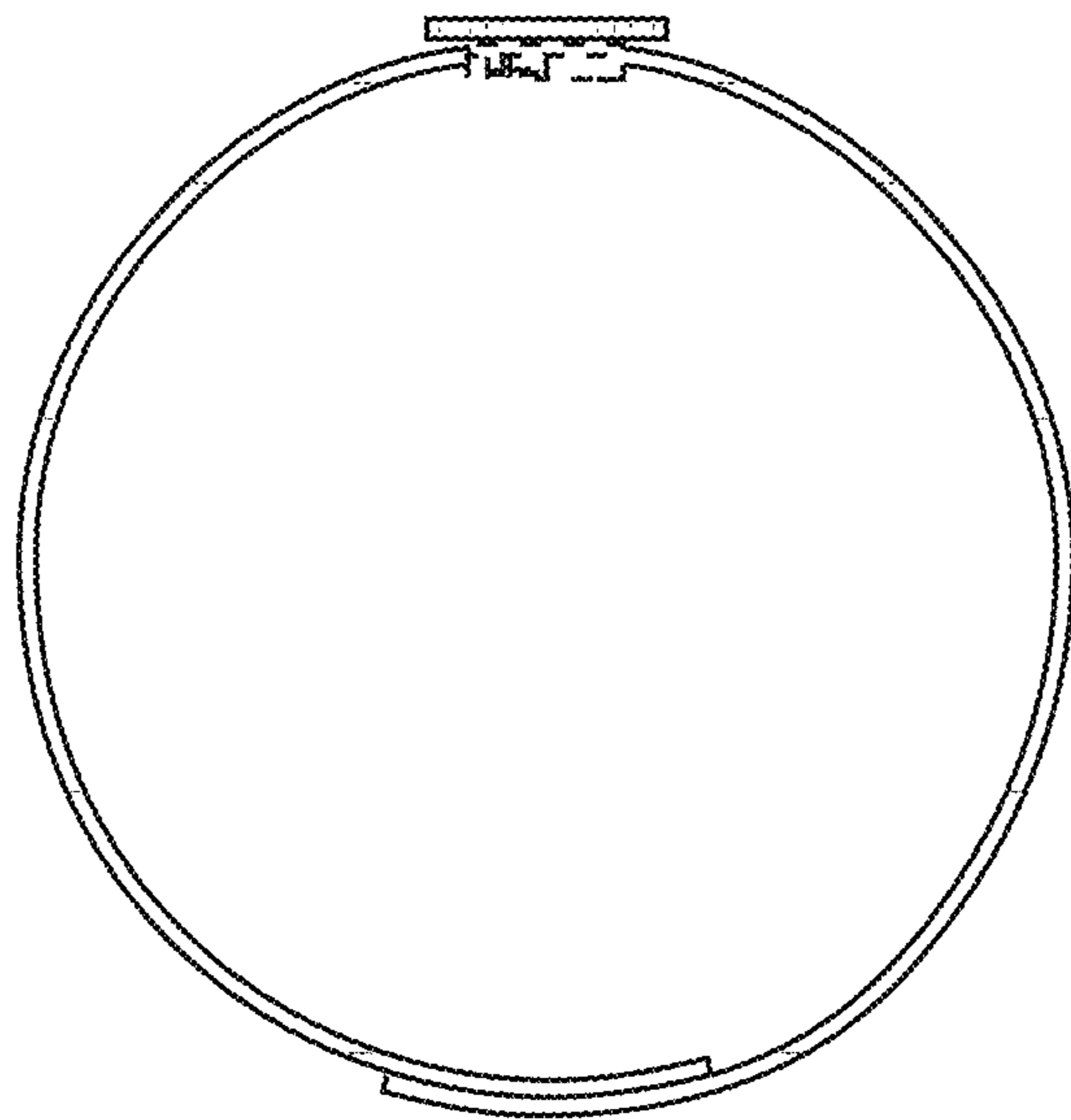

FIG. 6

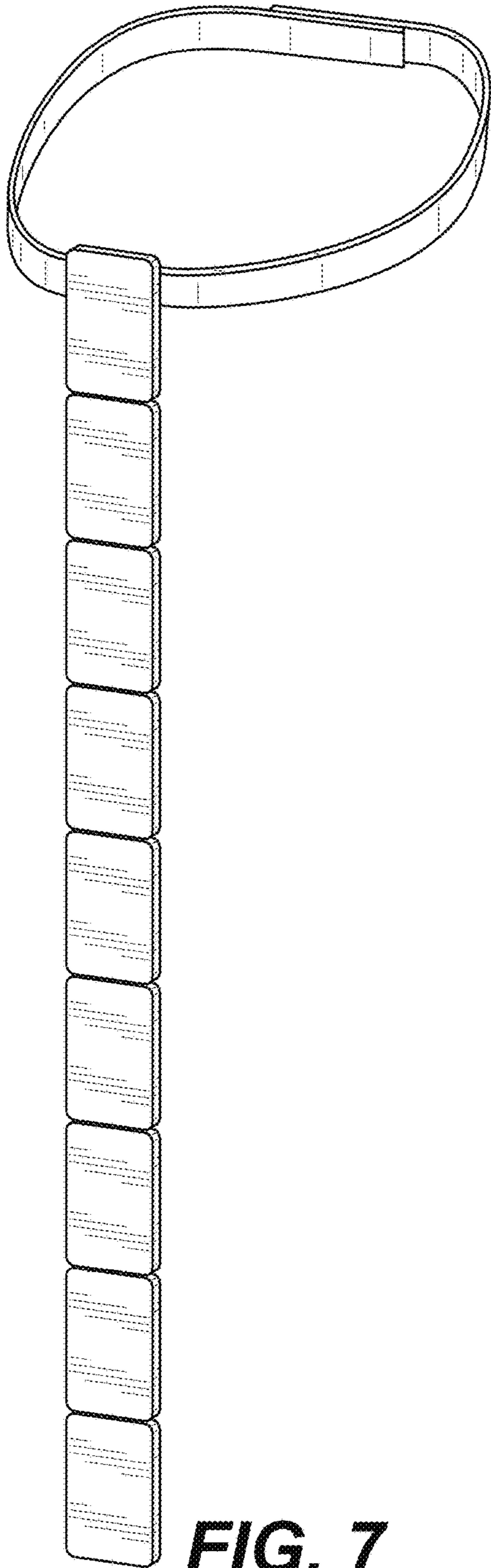

FIG. 7

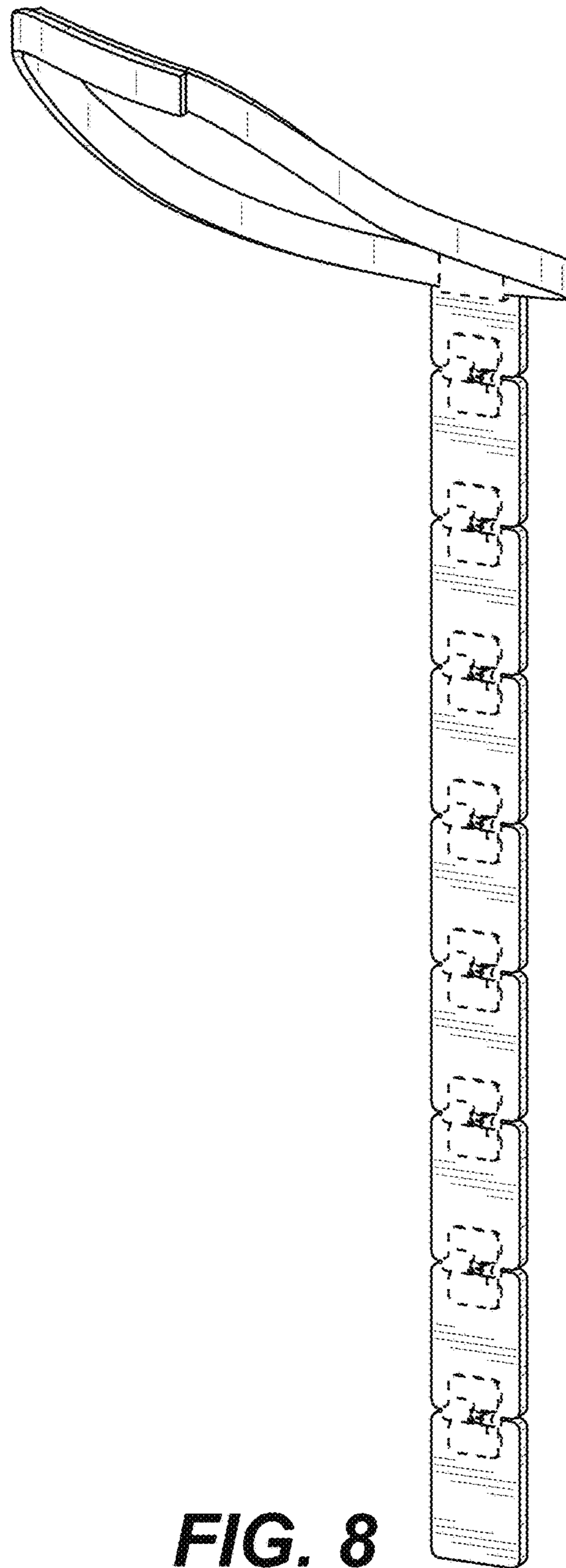

FIG. 8

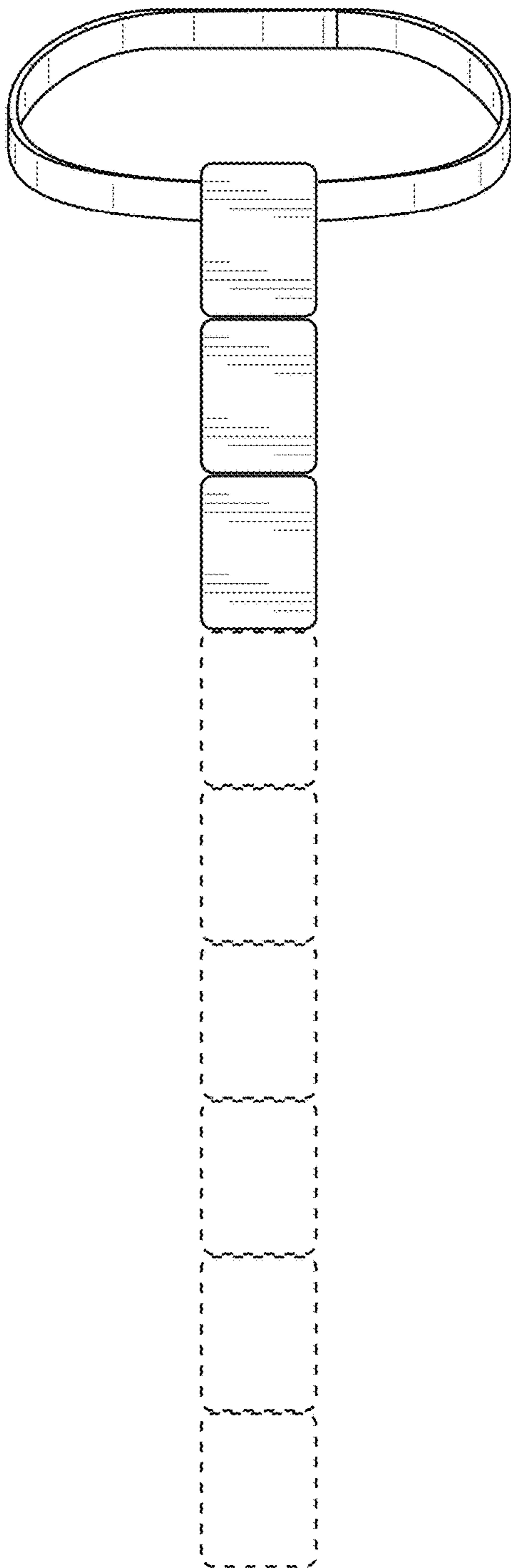

FIG. 9

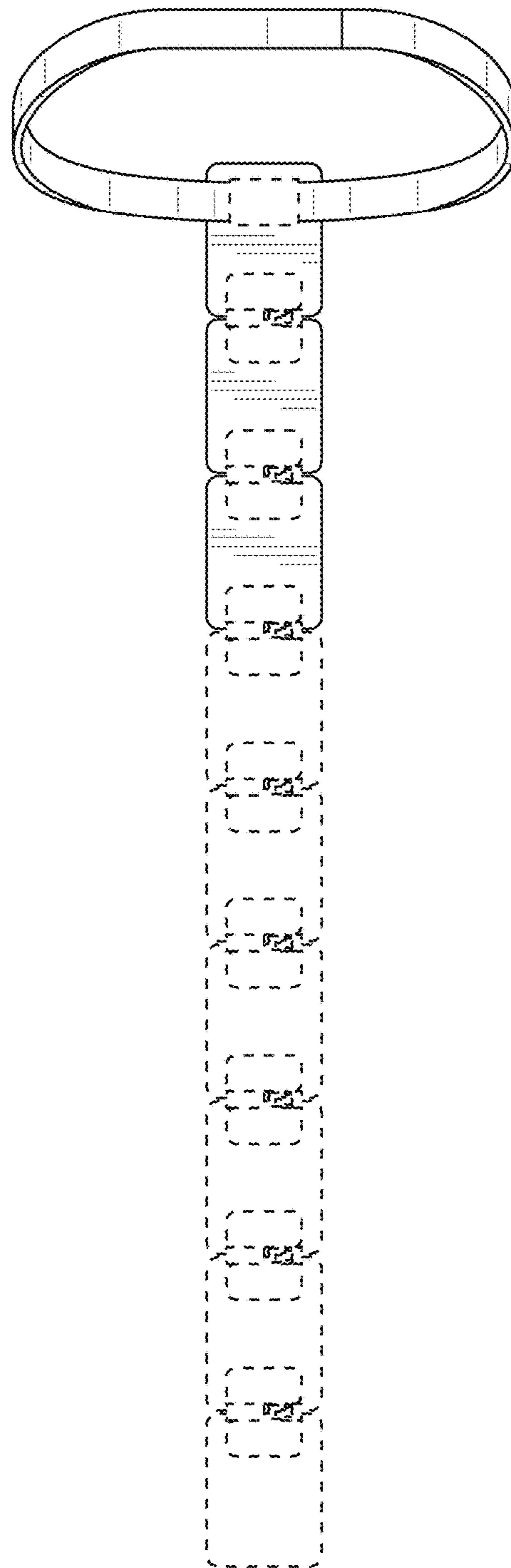

FIG. 10

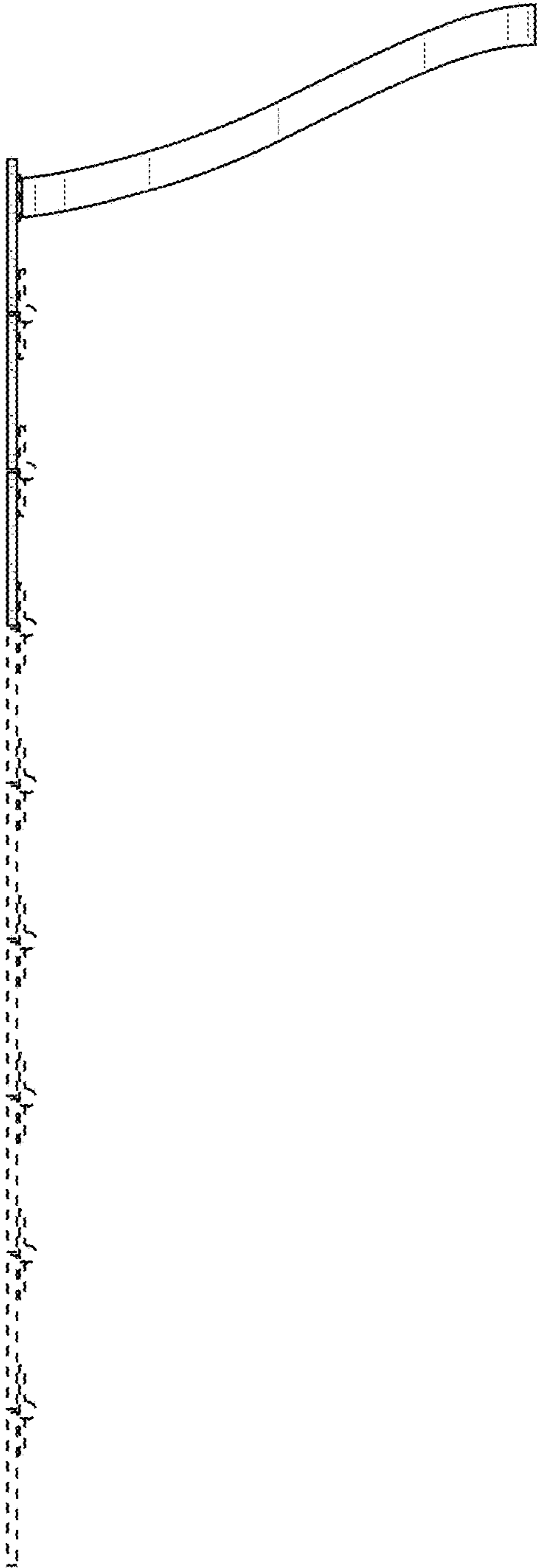

FIG. 11

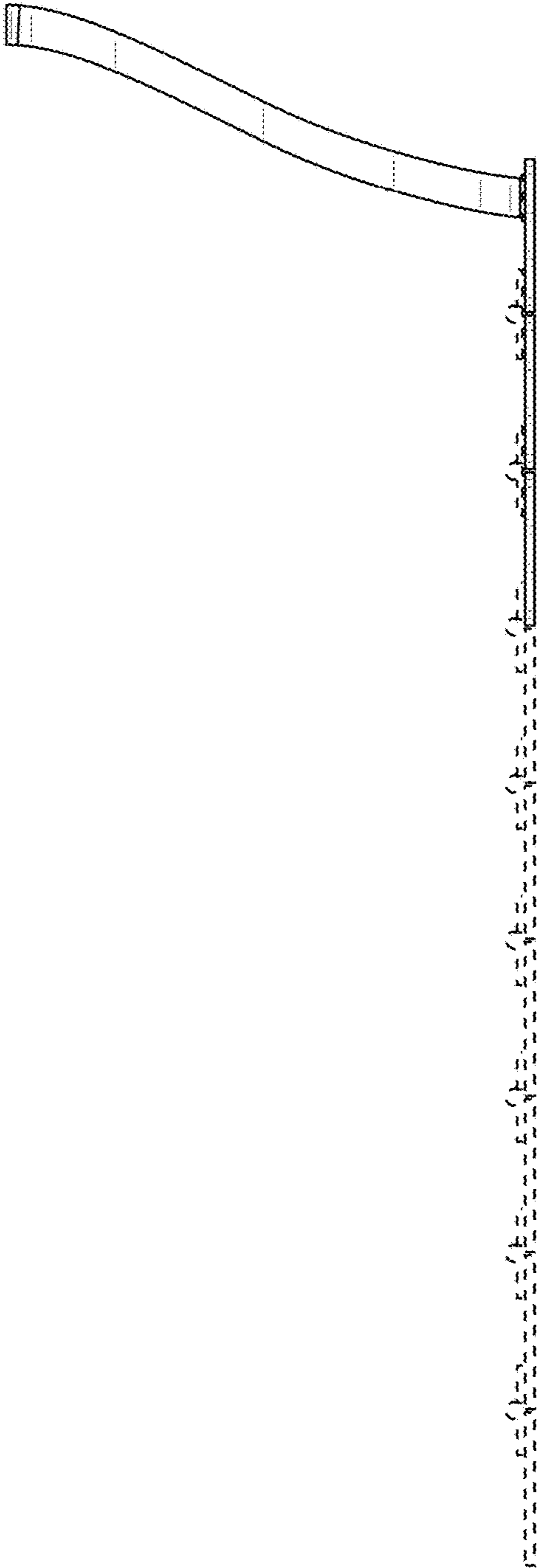

FIG. 12

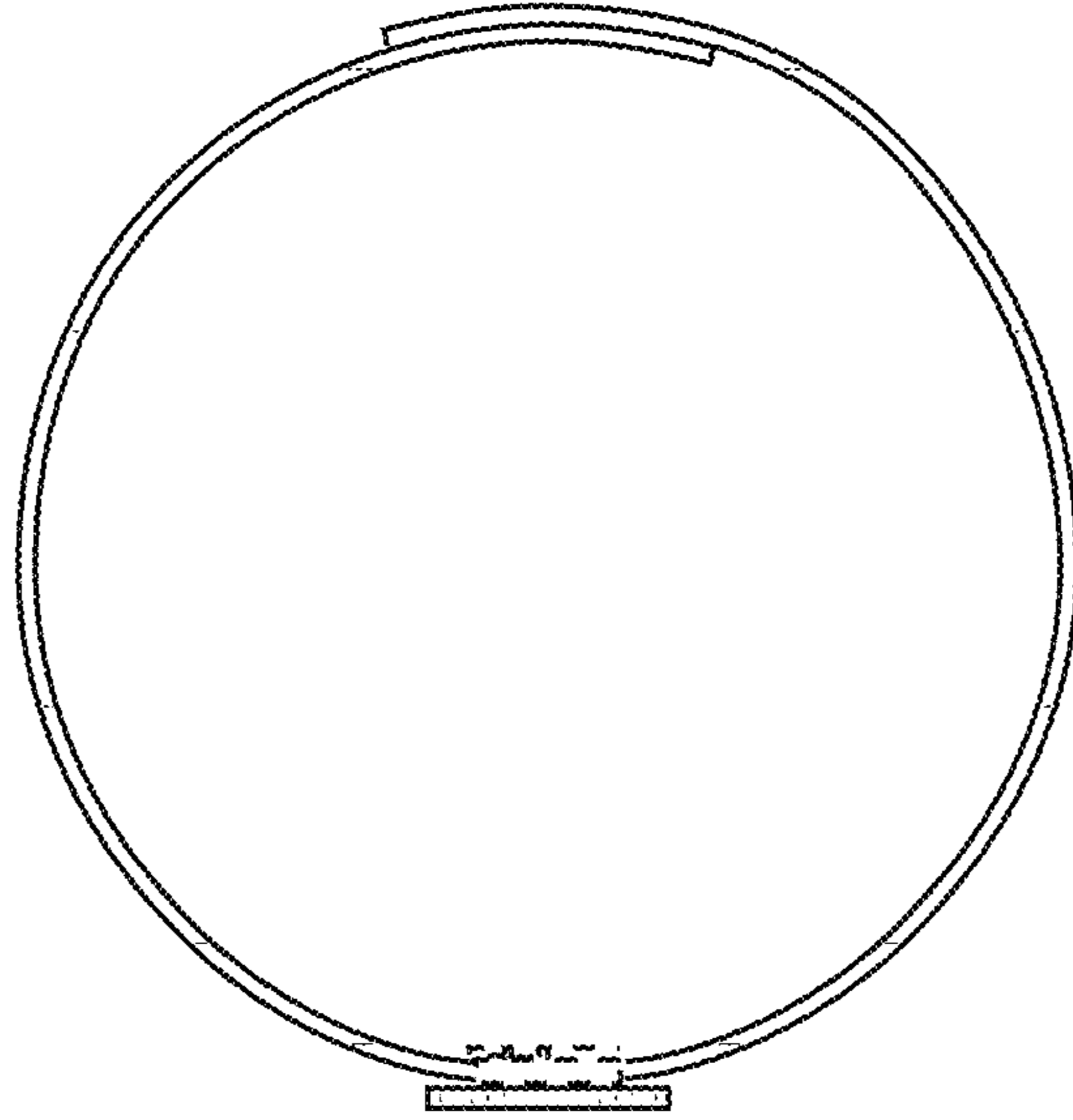

FIG. 13

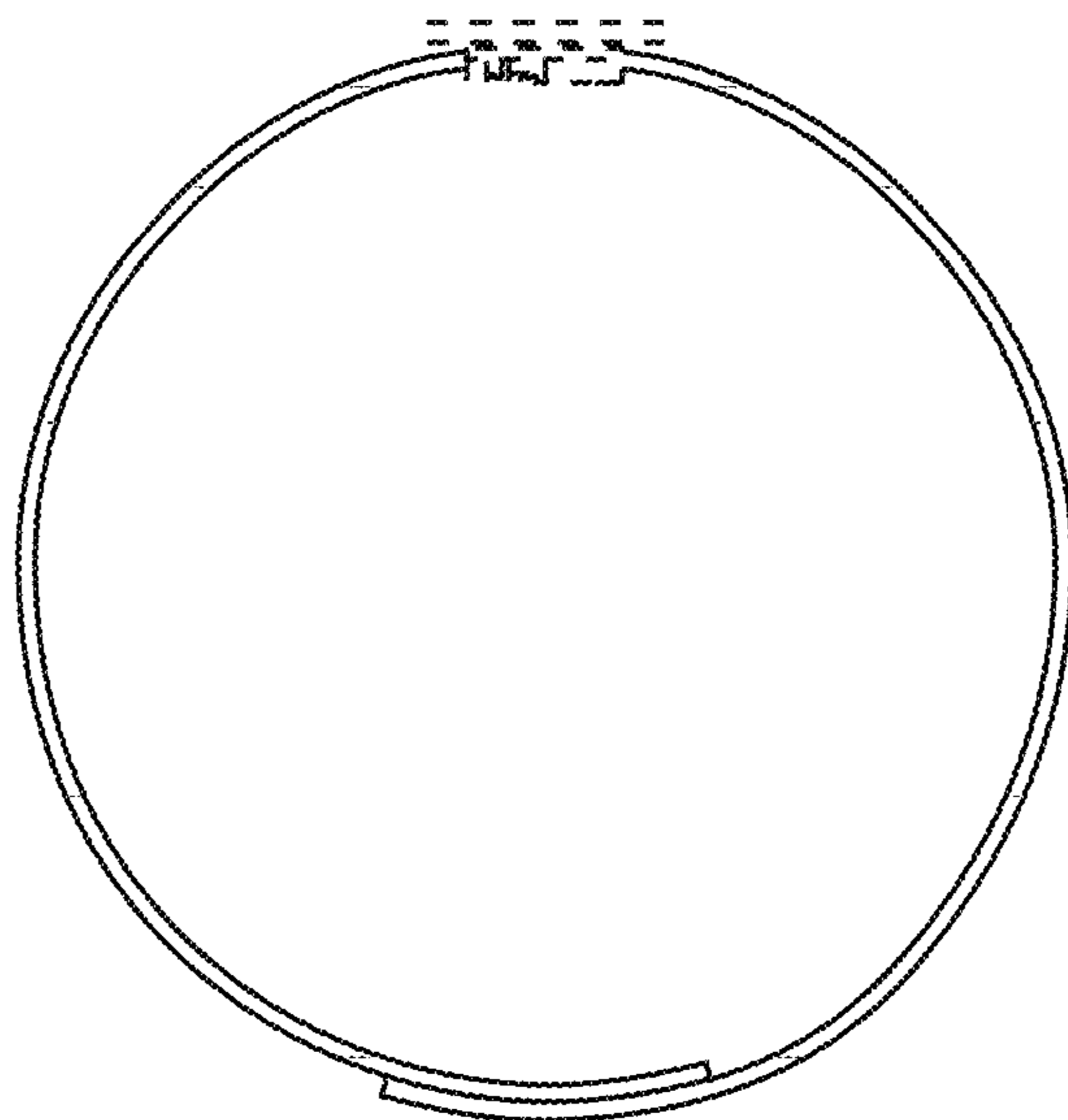

FIG. 14

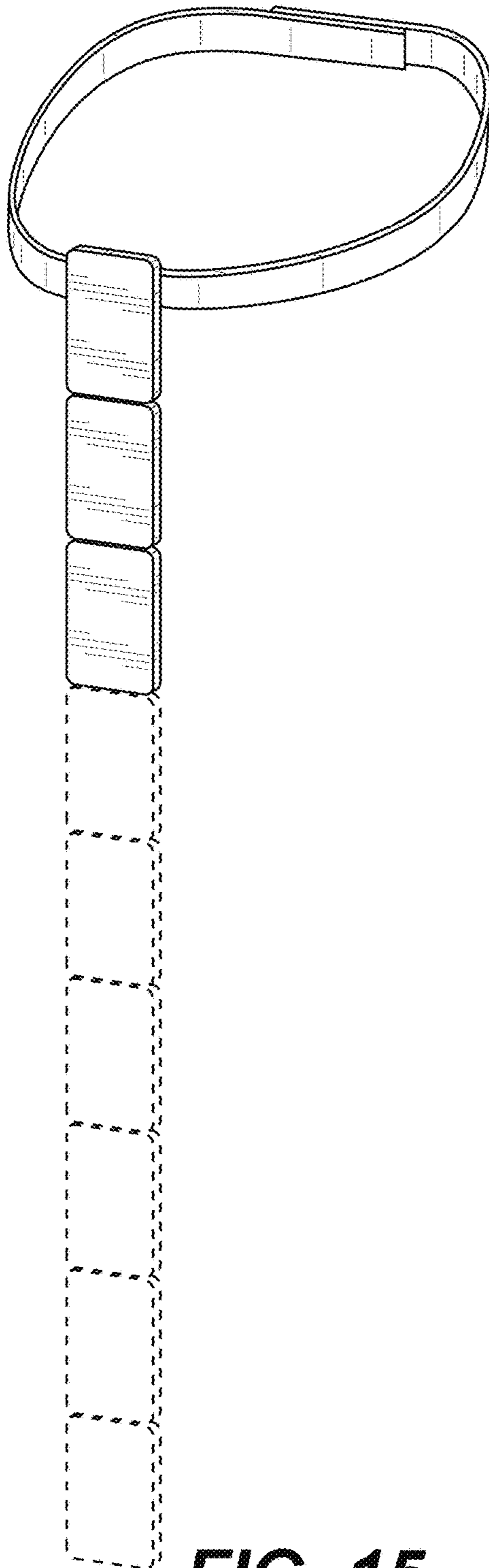

FIG. 15

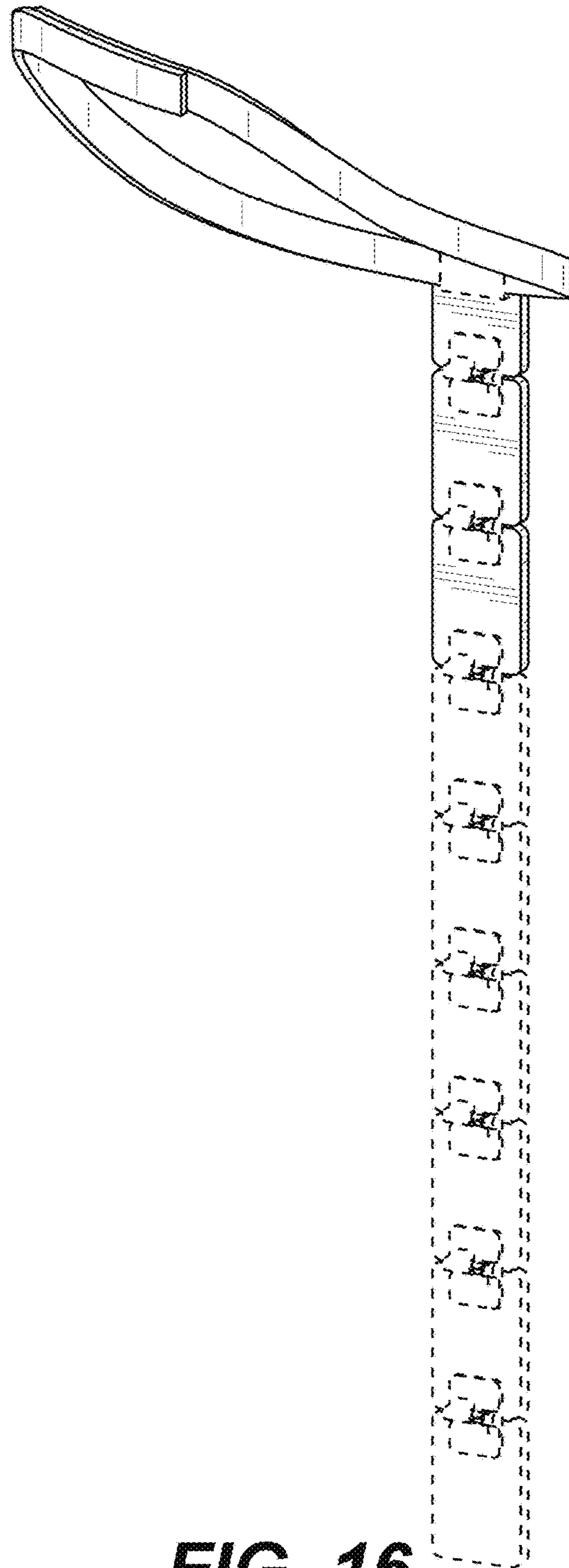

FIG. 16

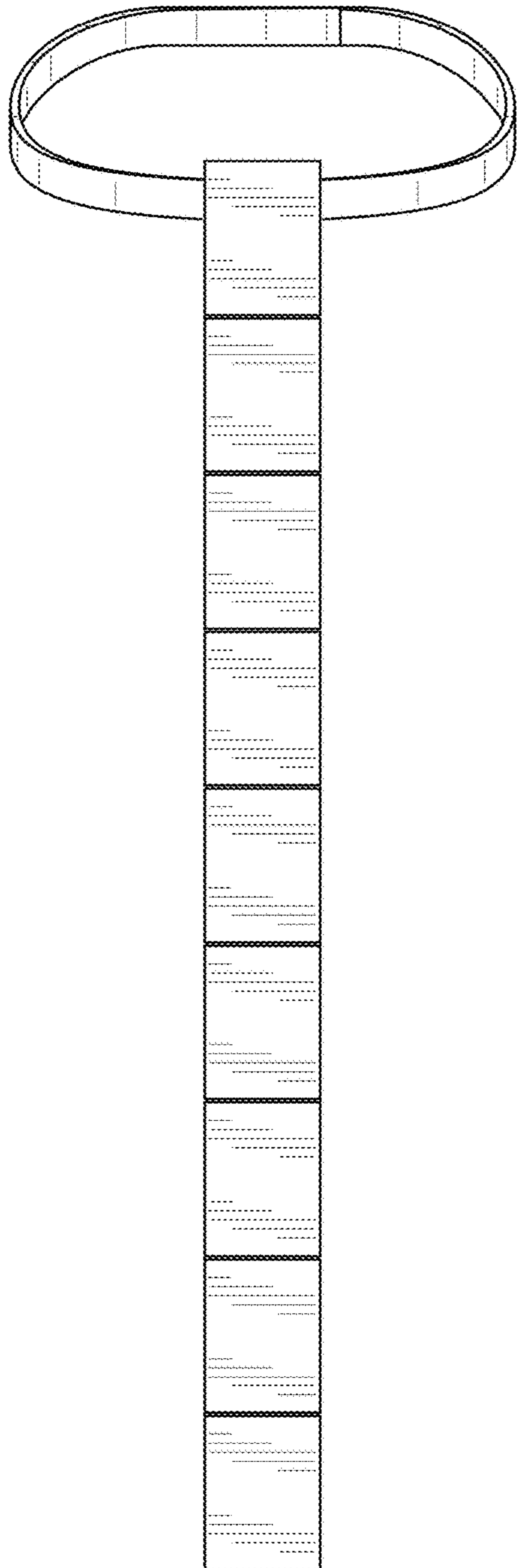

FIG. 17

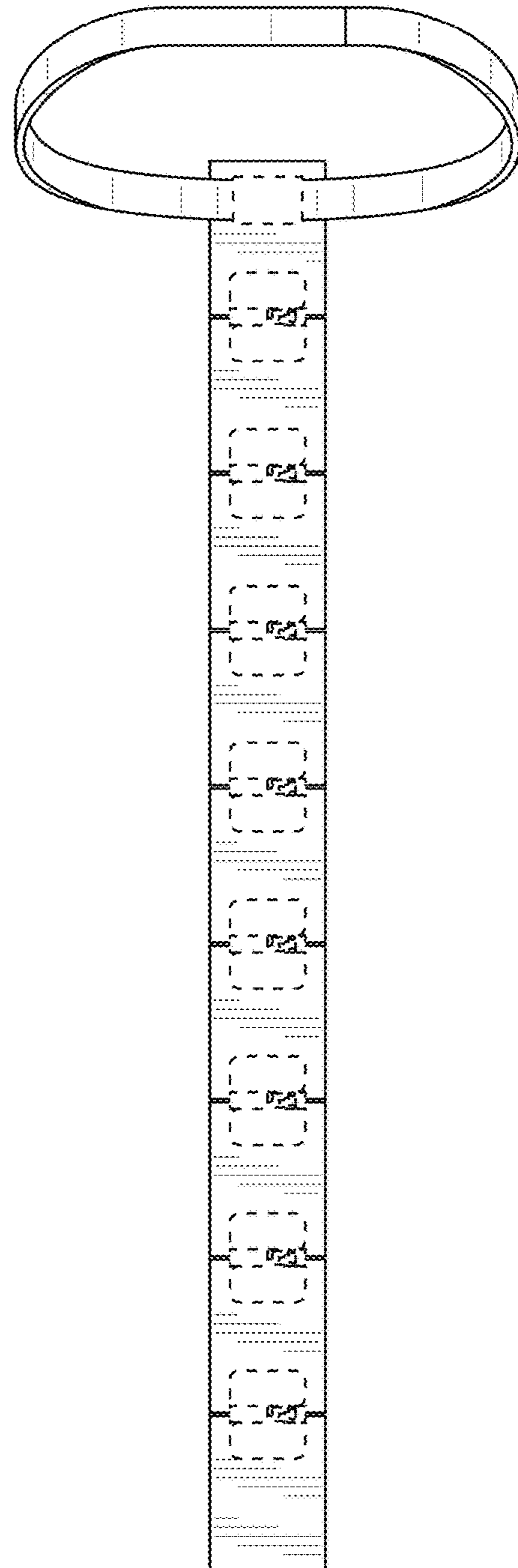

FIG. 18

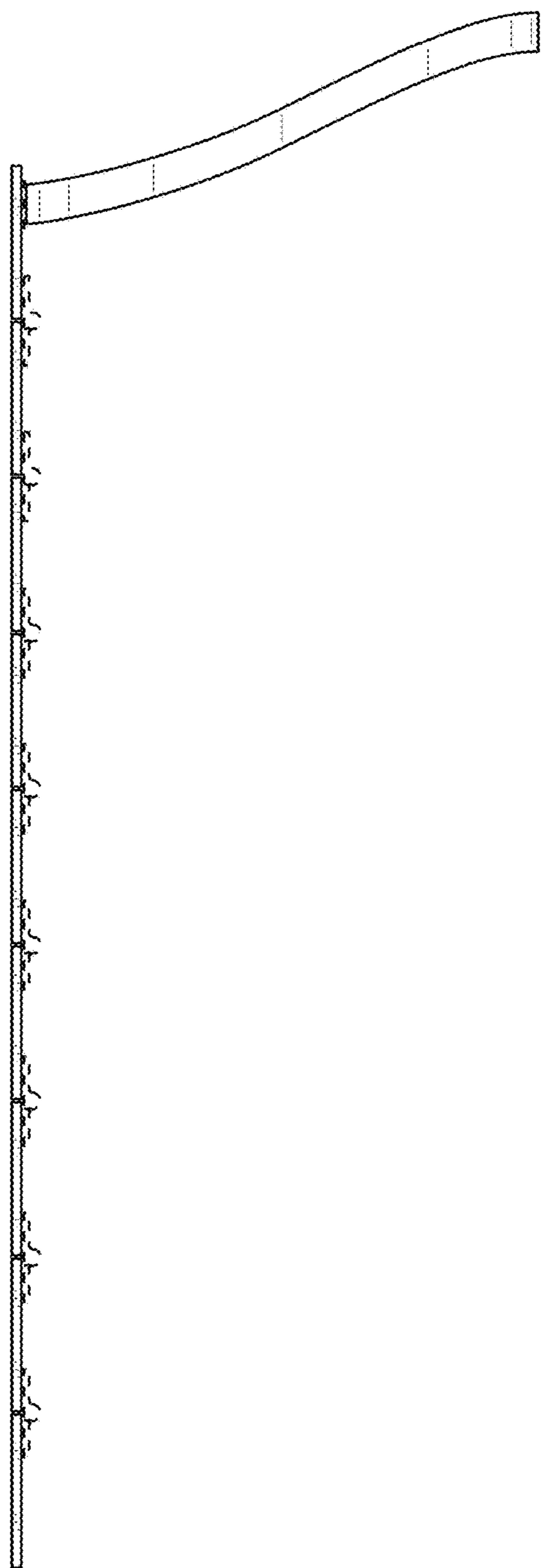

FIG. 19

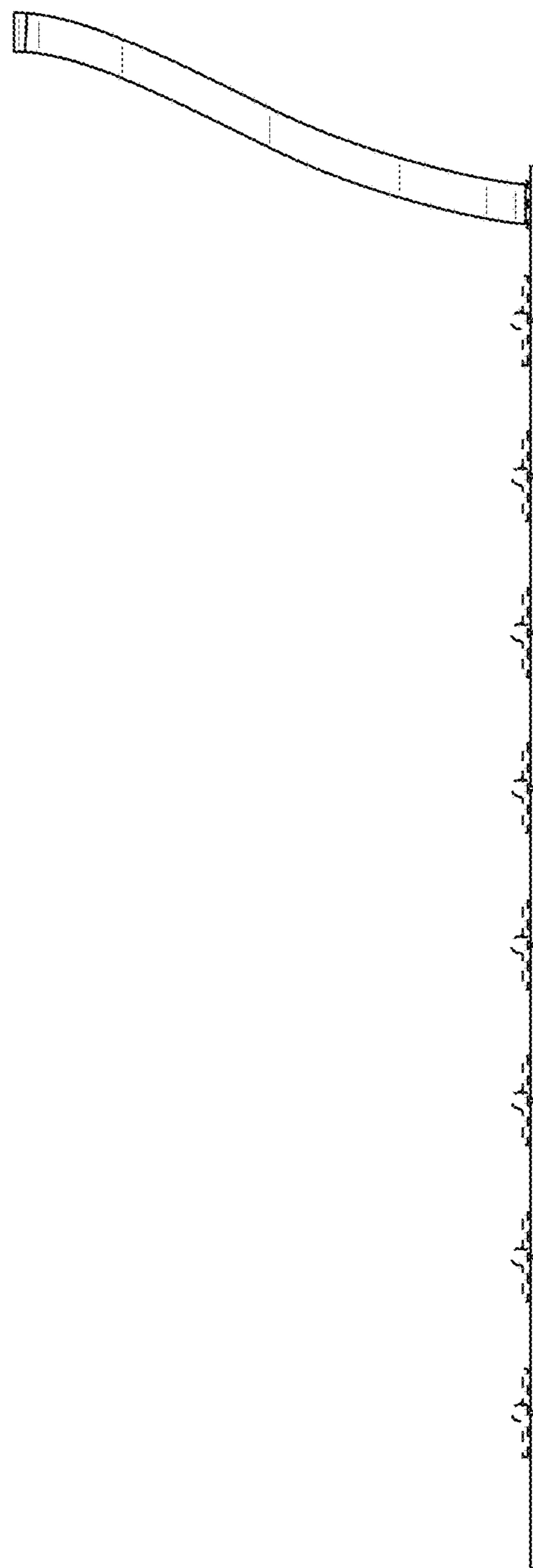

FIG. 20

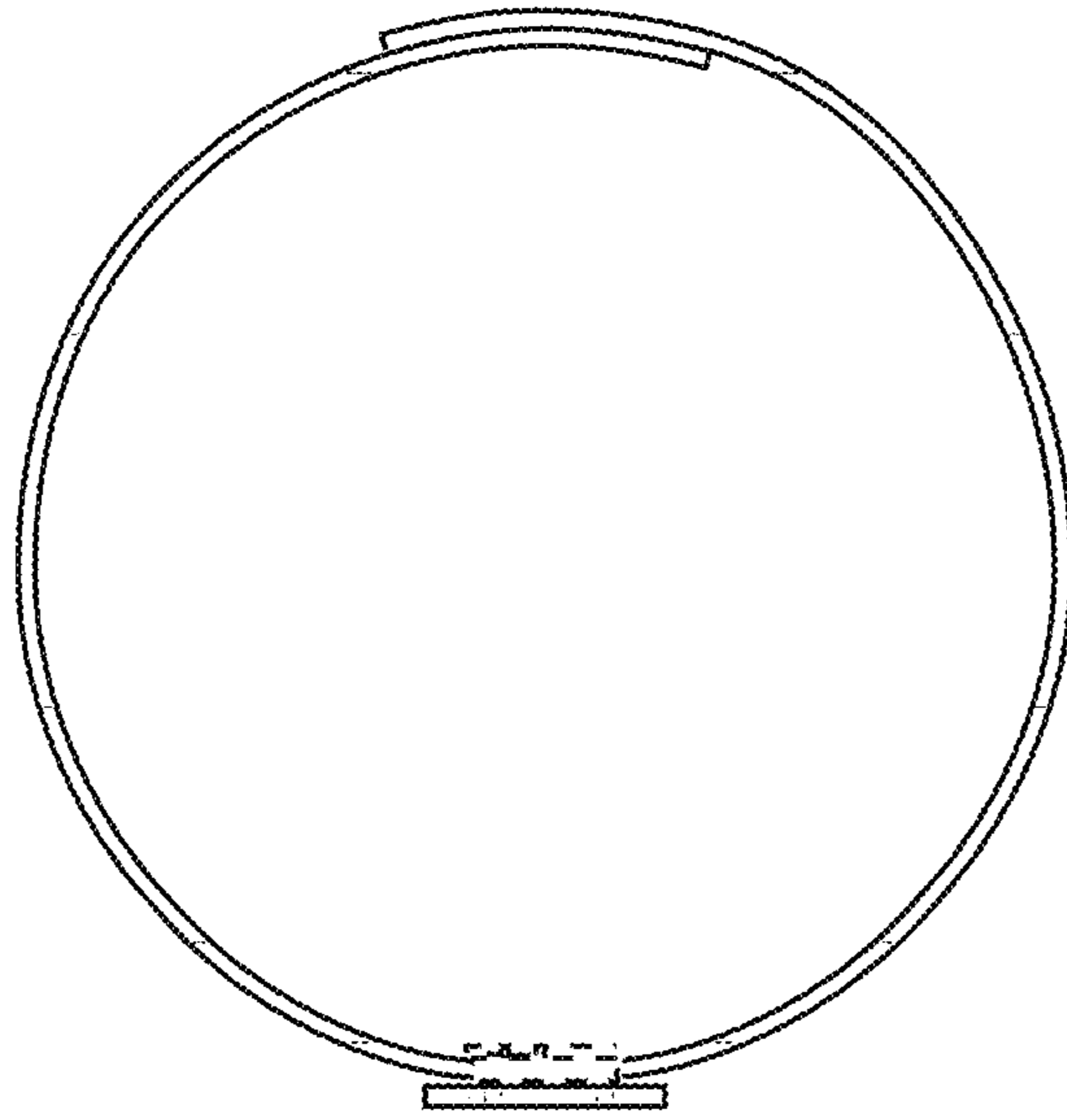

FIG. 21

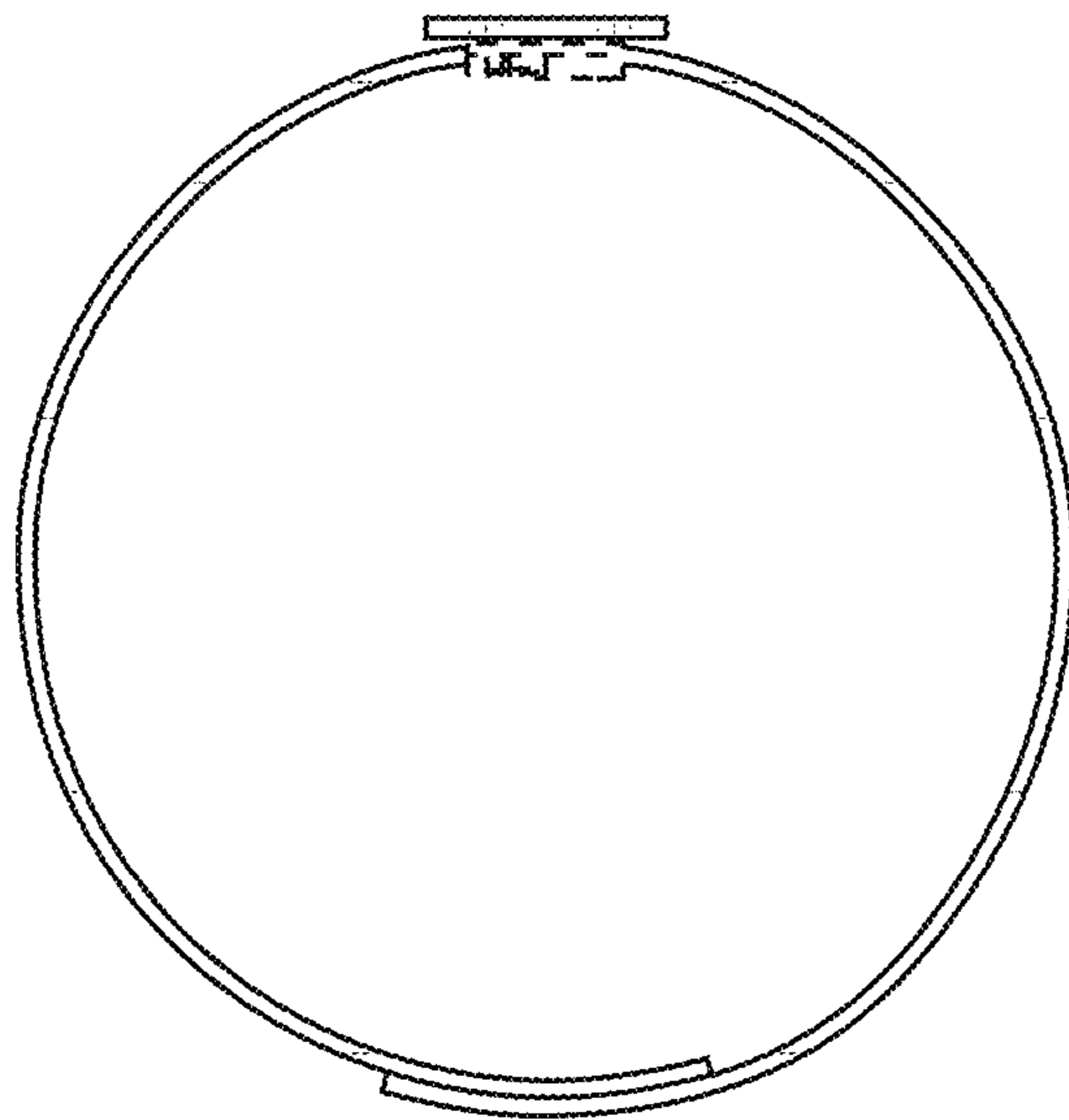

FIG. 22

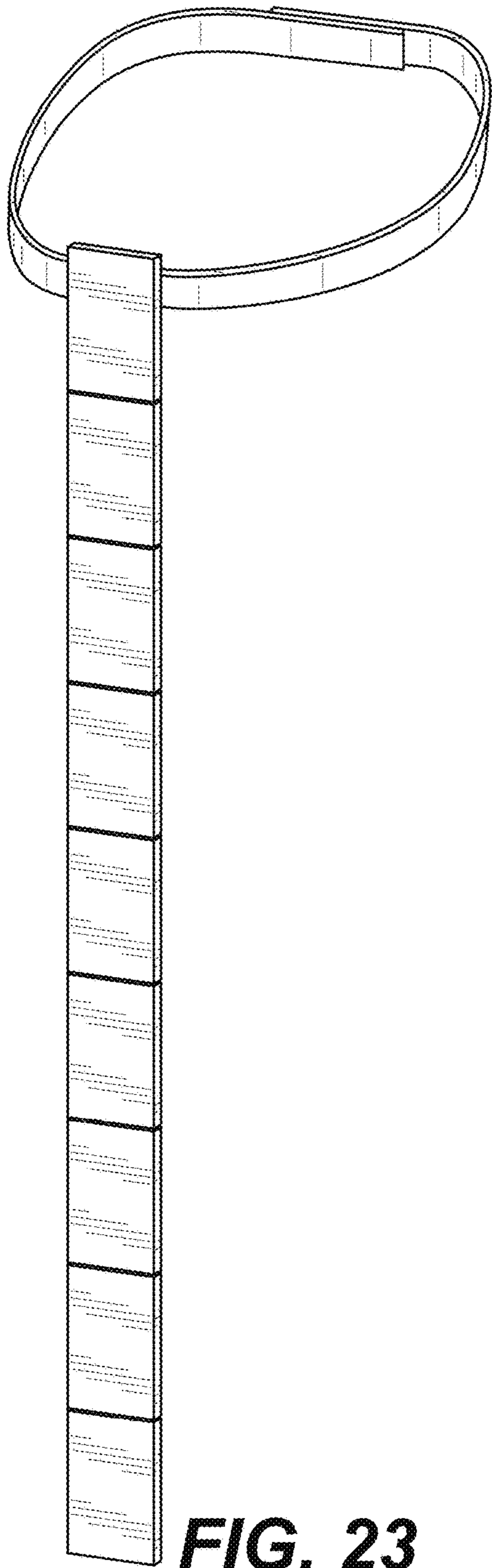

FIG. 23

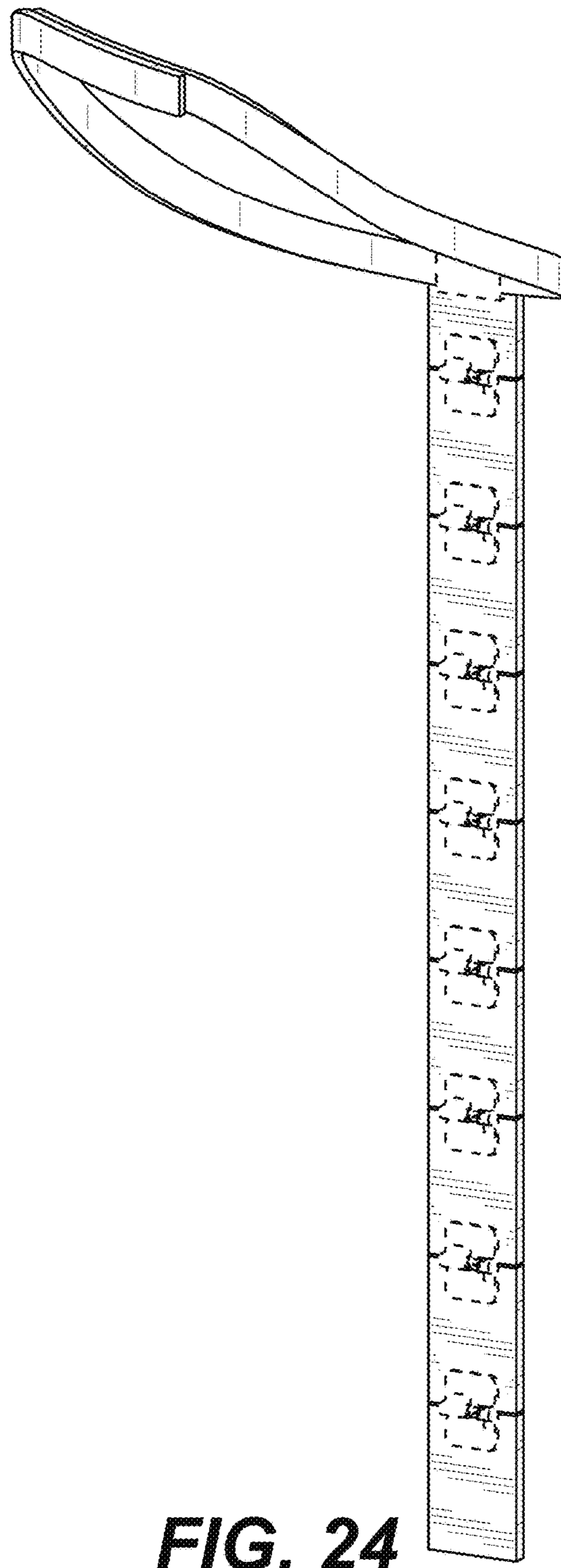

FIG. 24

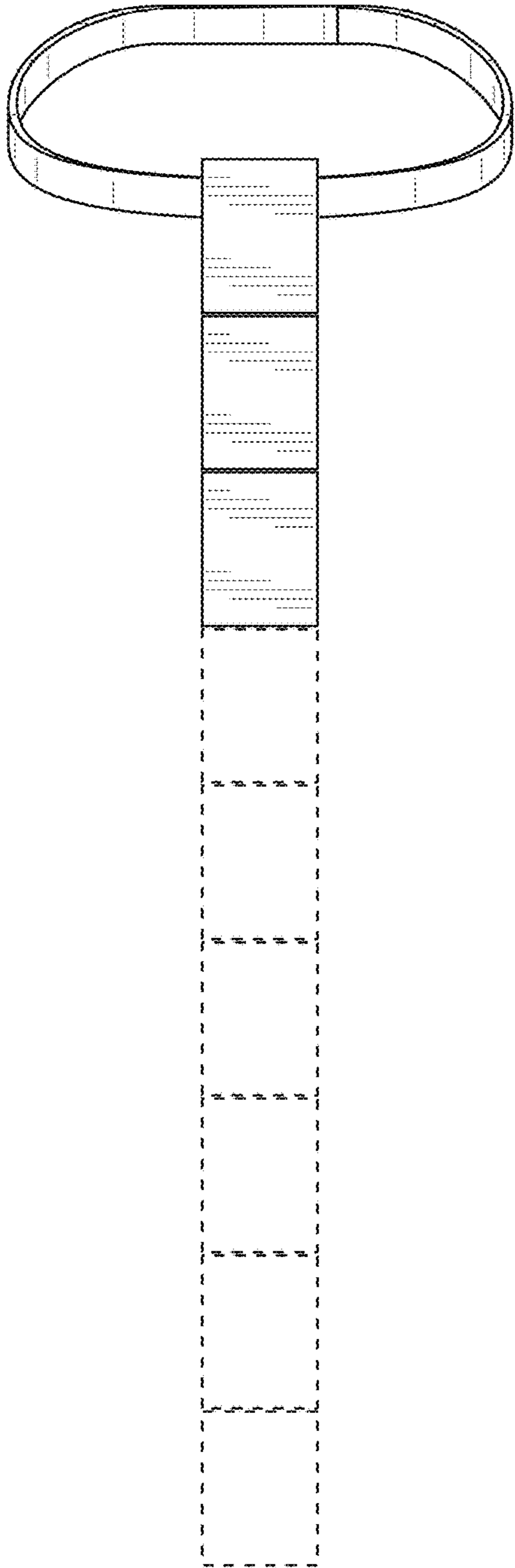

FIG. 25

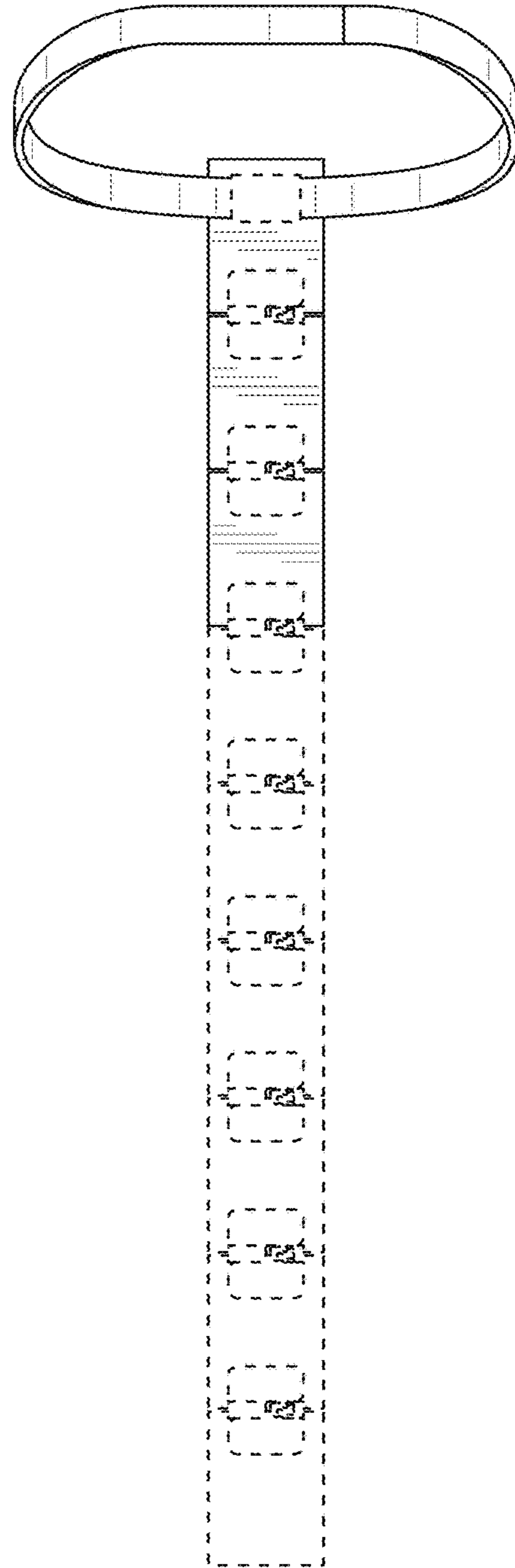

FIG. 26

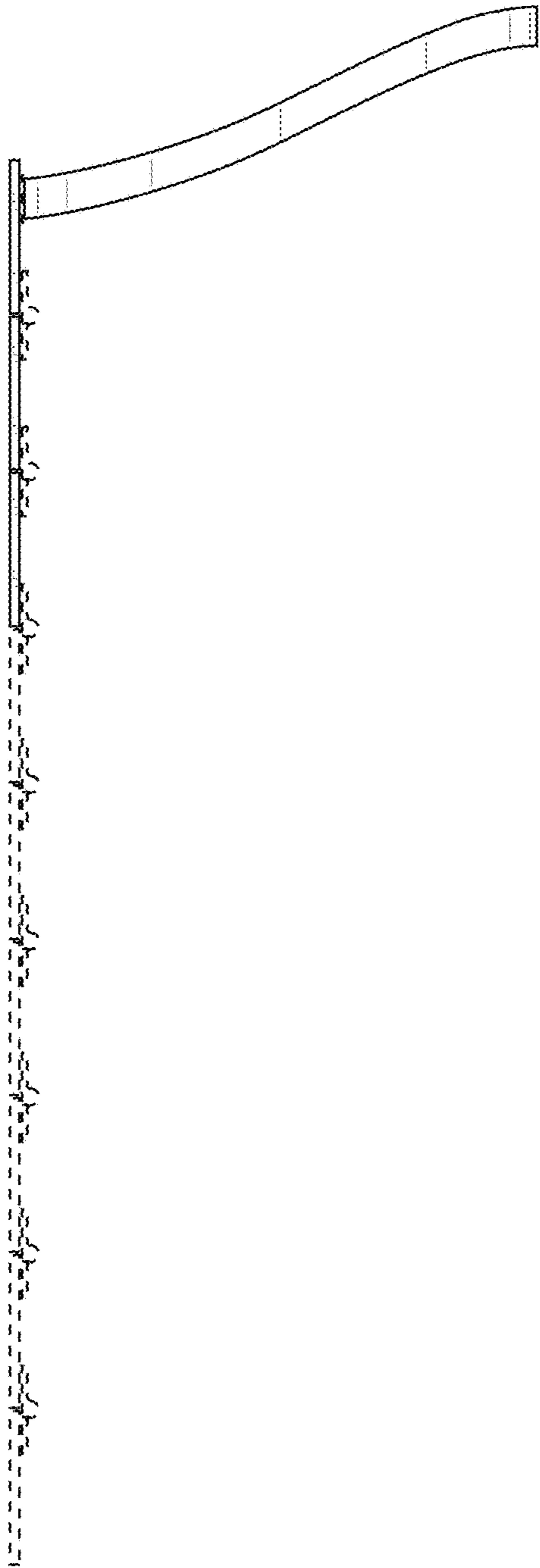

FIG. 27

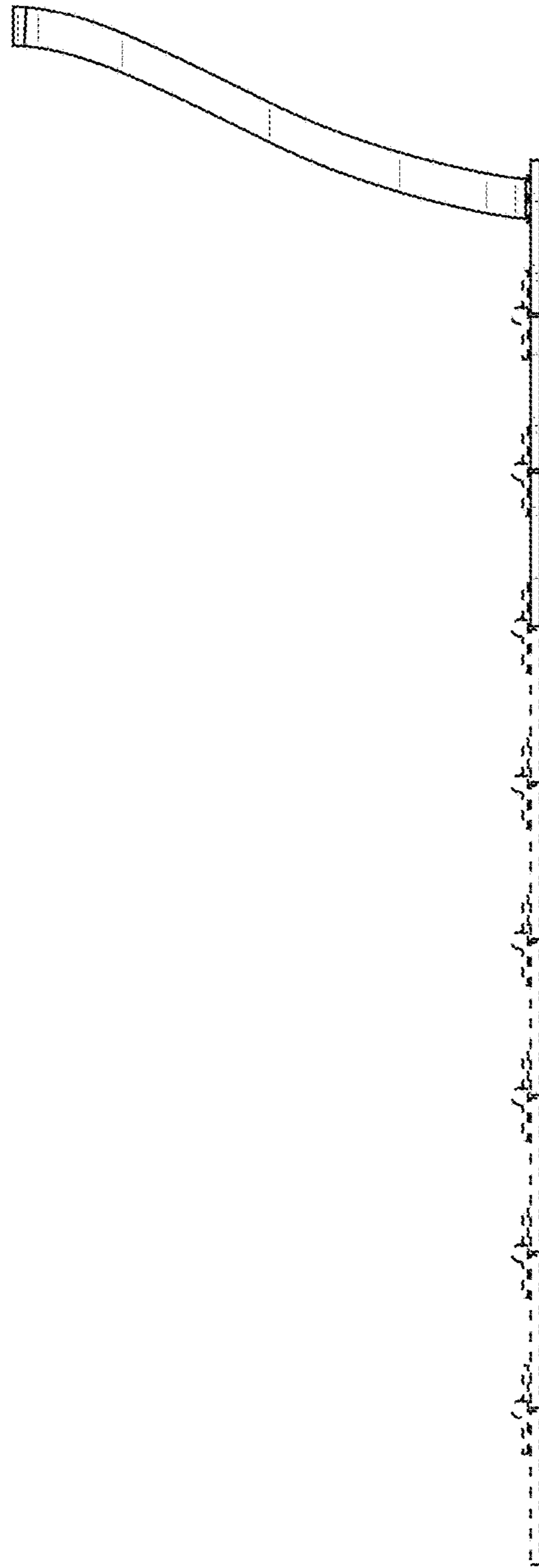

FIG. 28

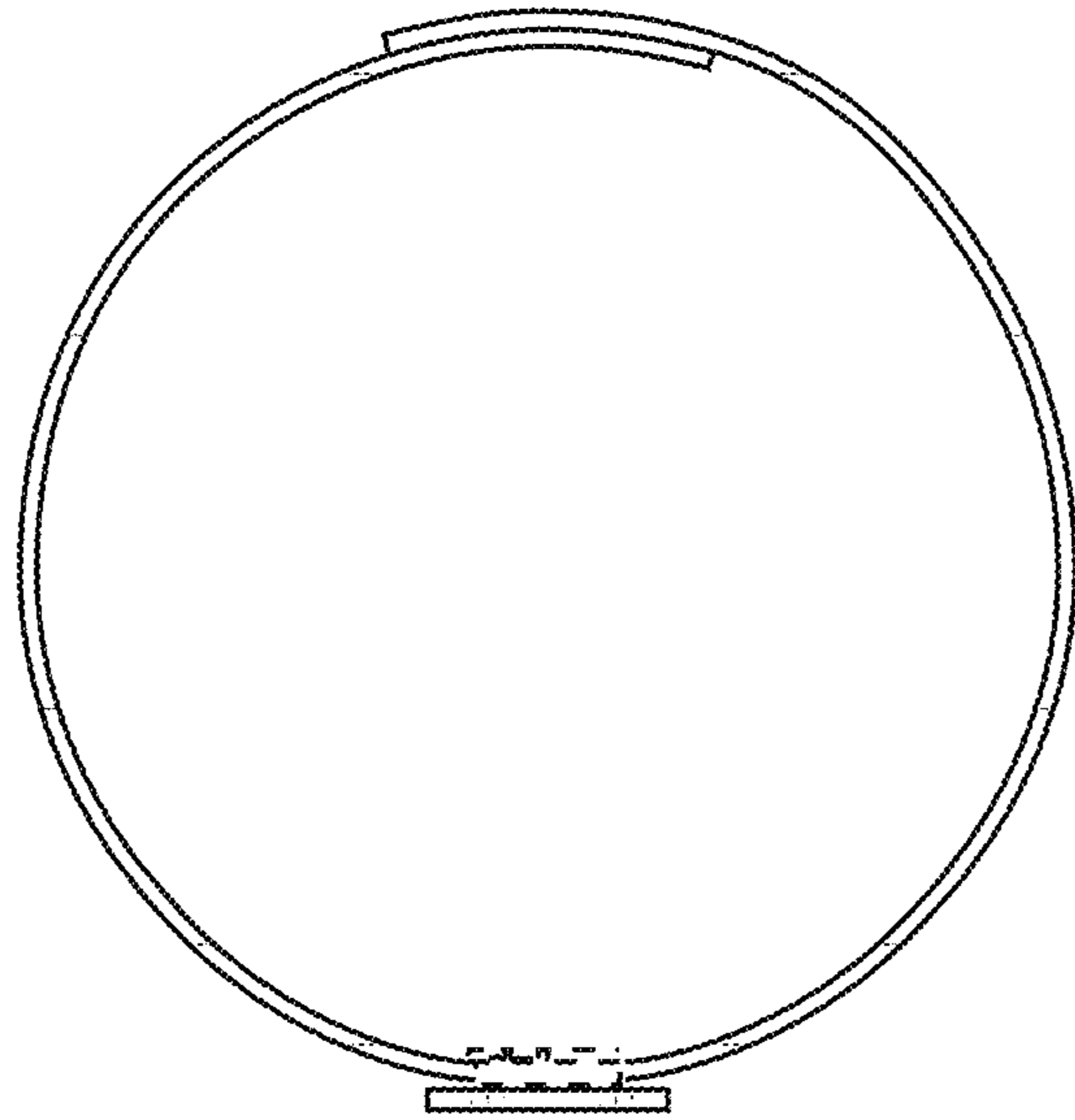

FIG. 29

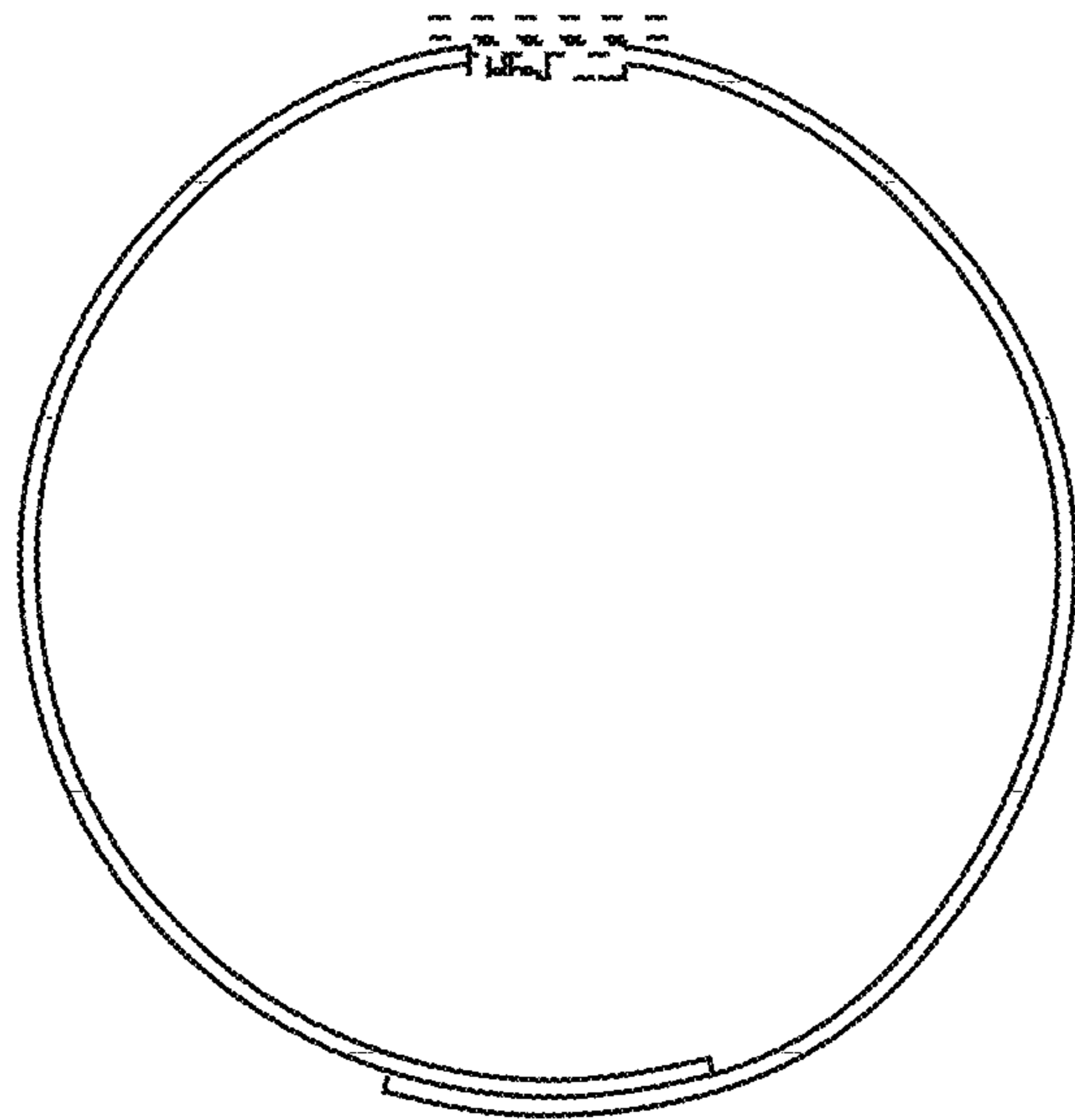

FIG. 30

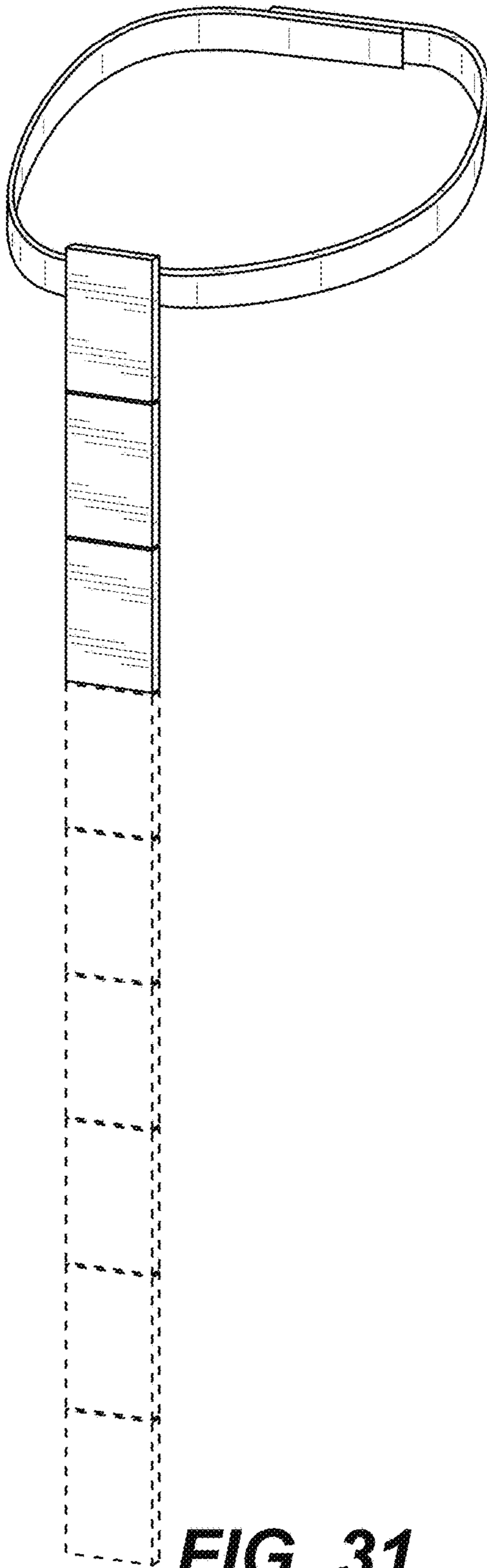

FIG. 31

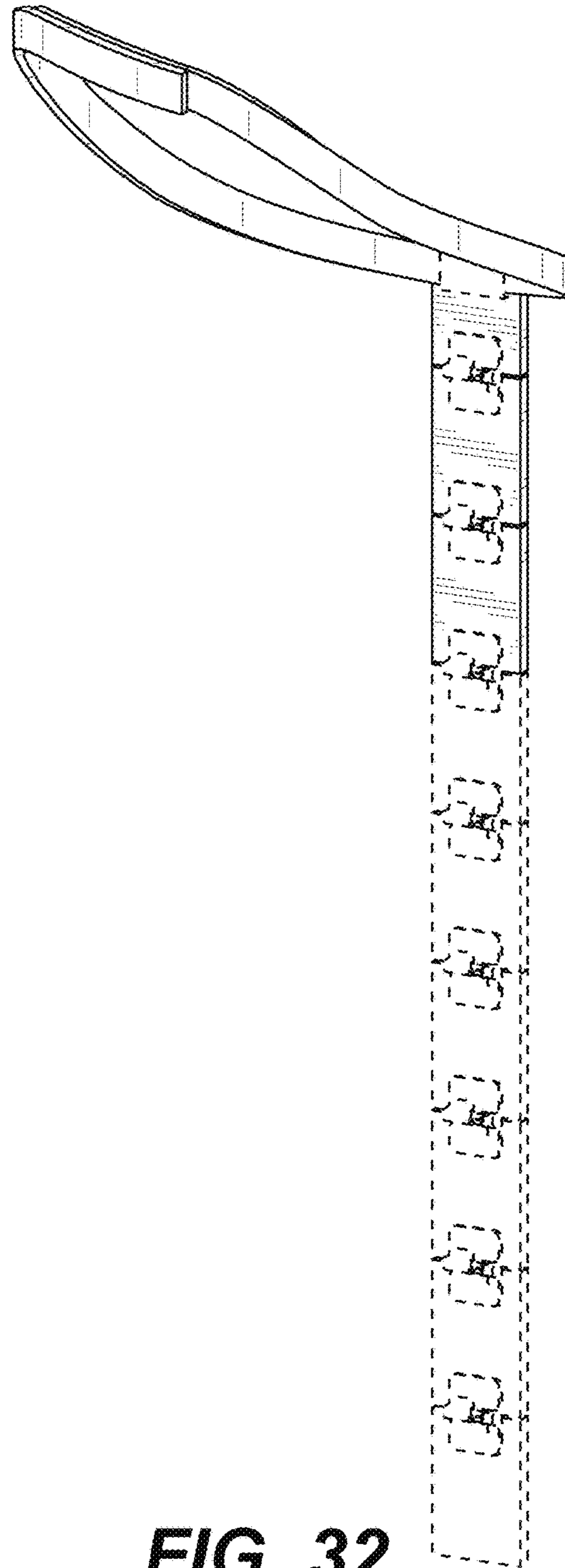

FIG. 32

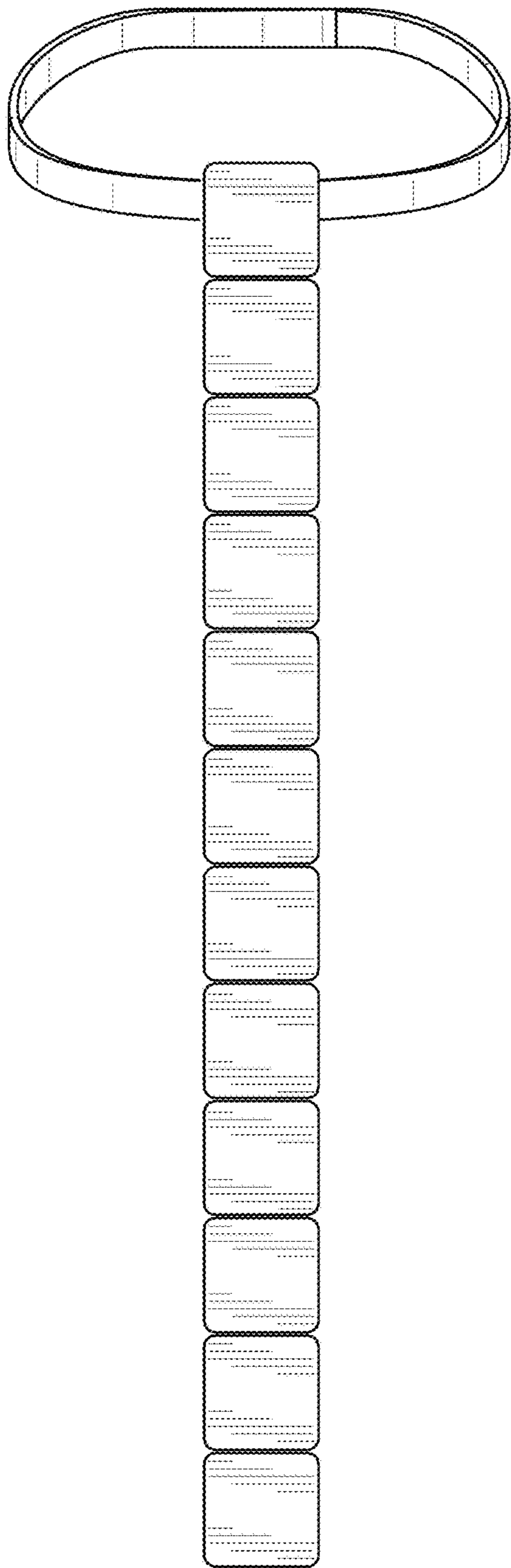

FIG. 33

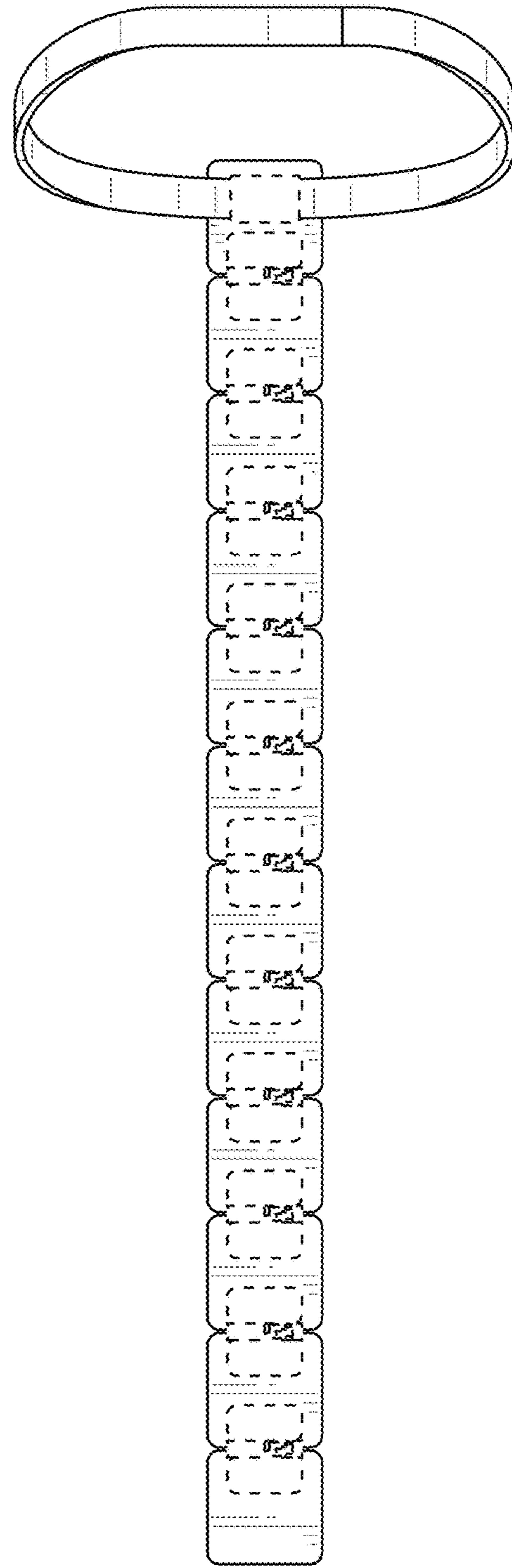

FIG. 34

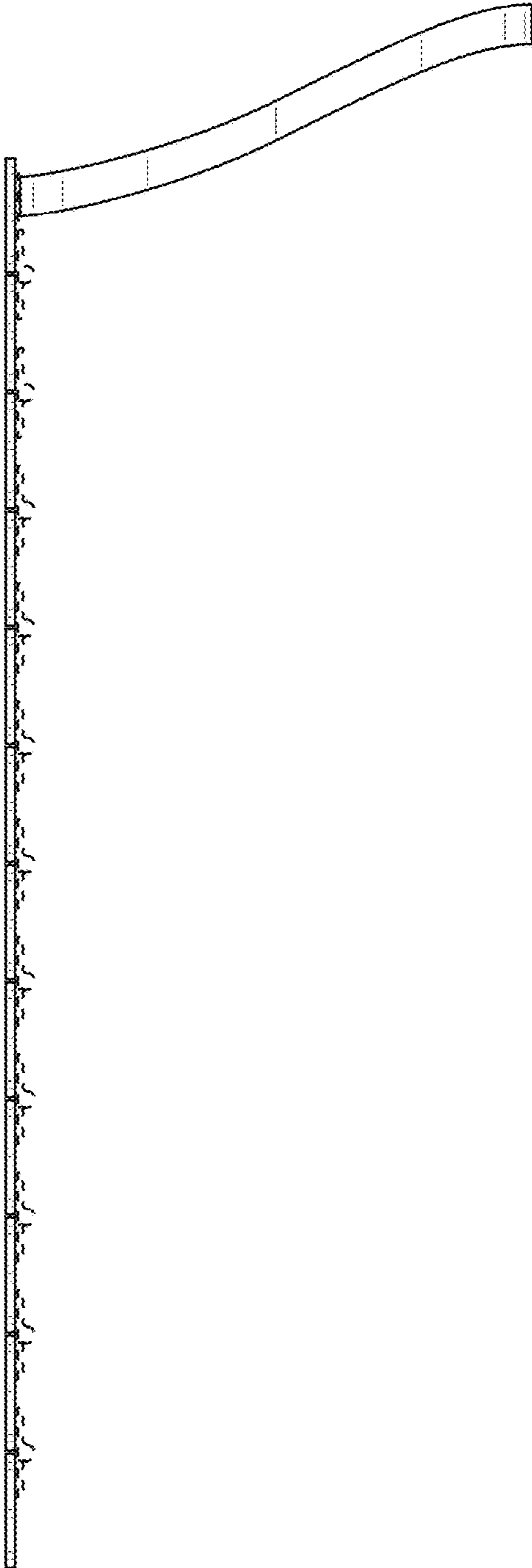

FIG. 35

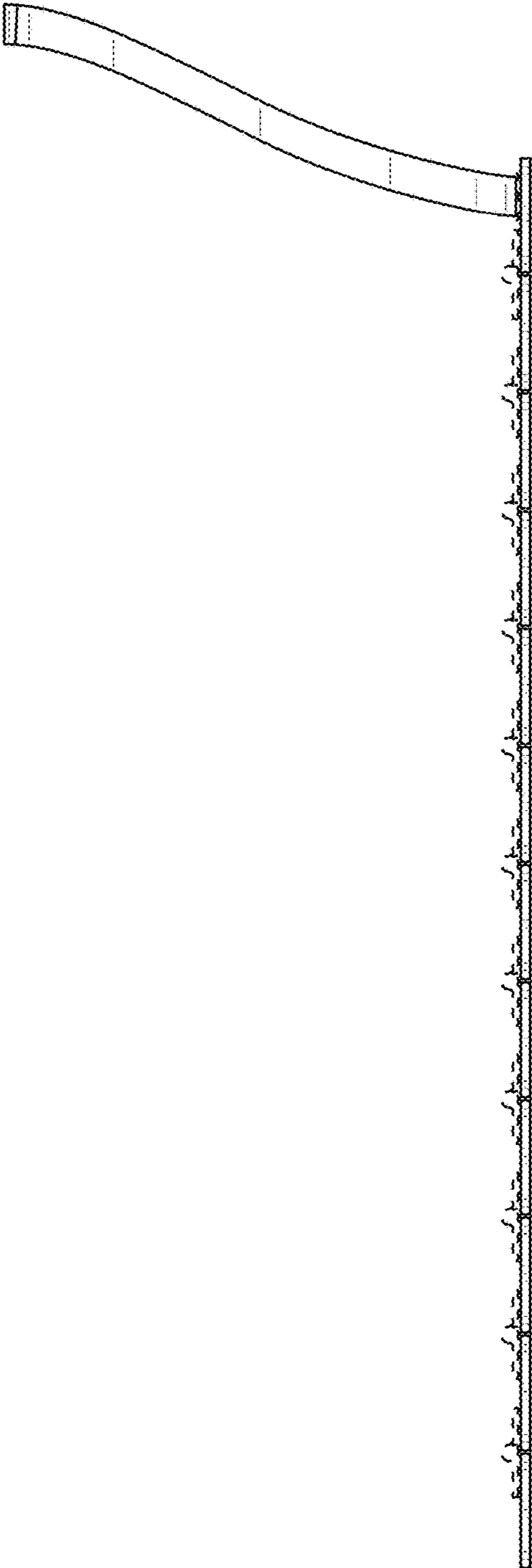

FIG. 36

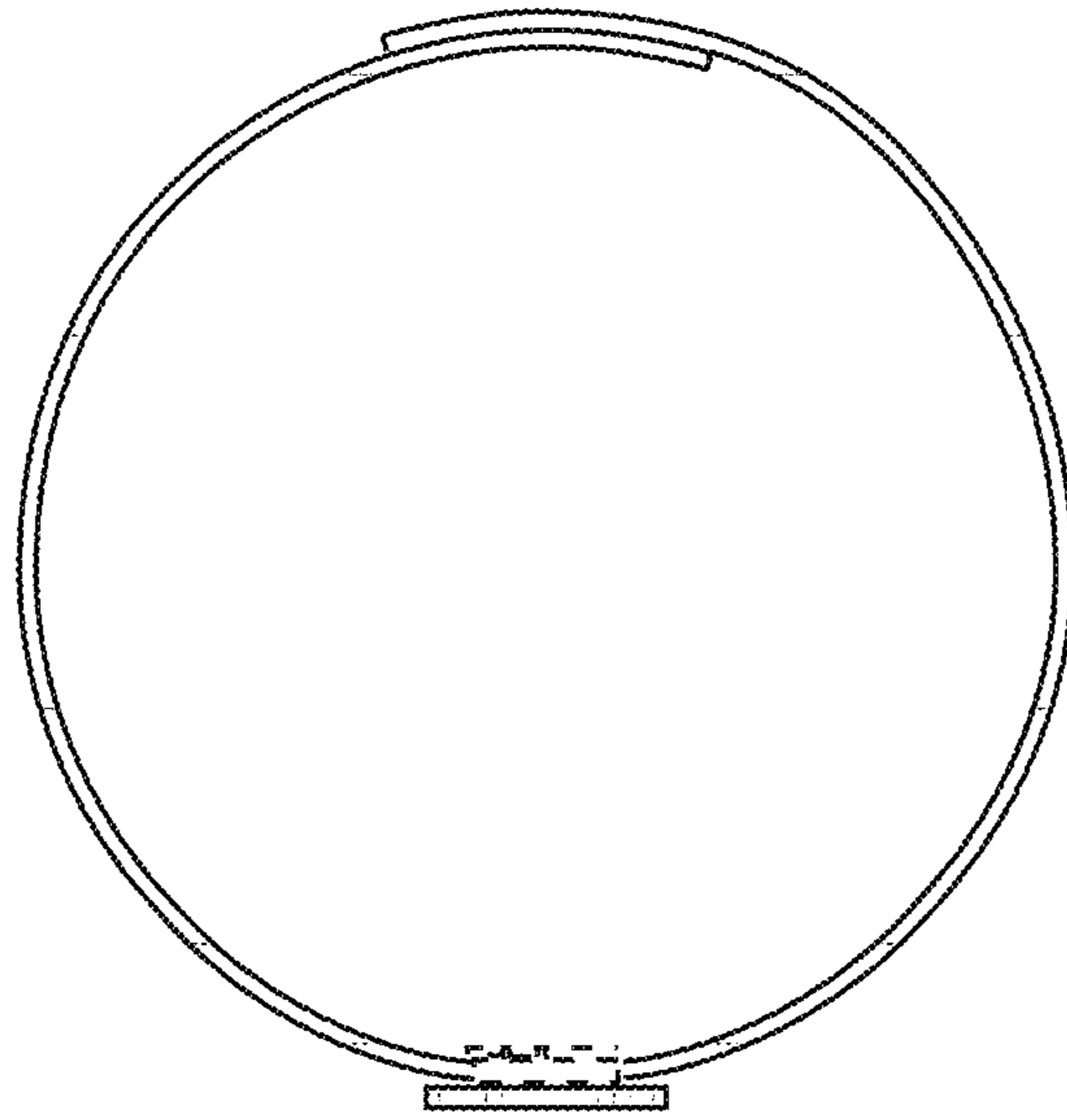

FIG. 37

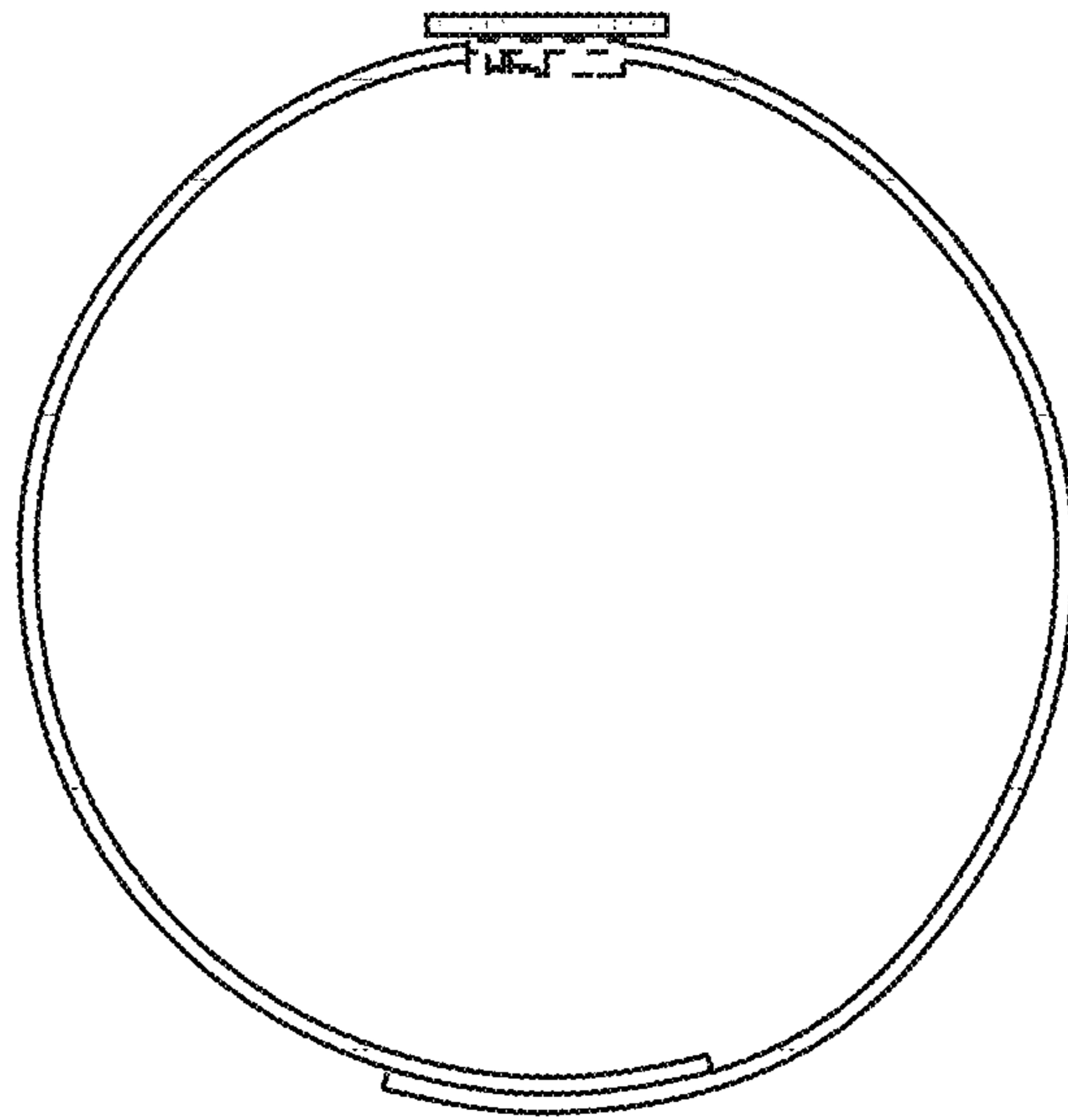

FIG. 38

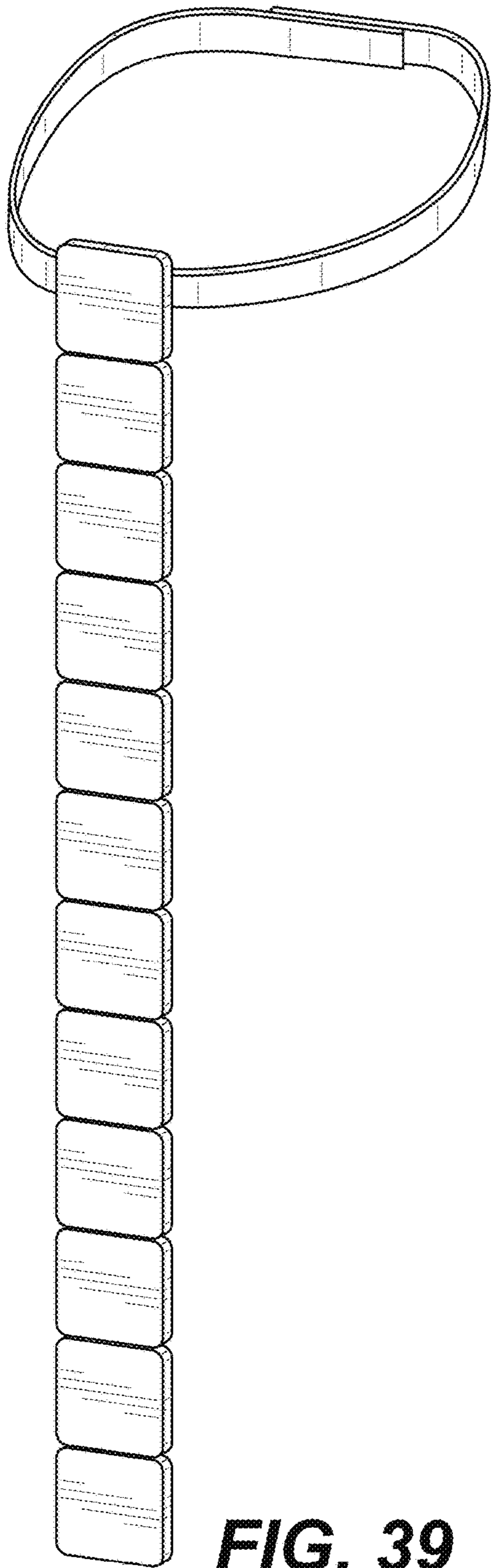

FIG. 39

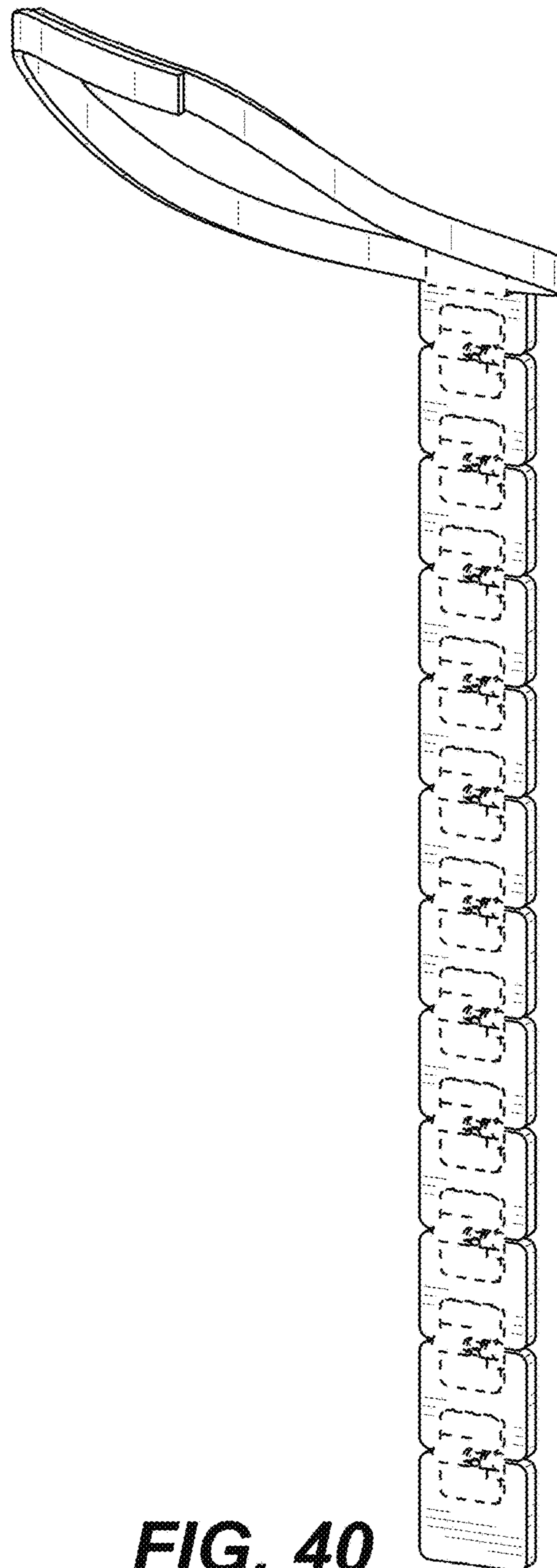

FIG. 40

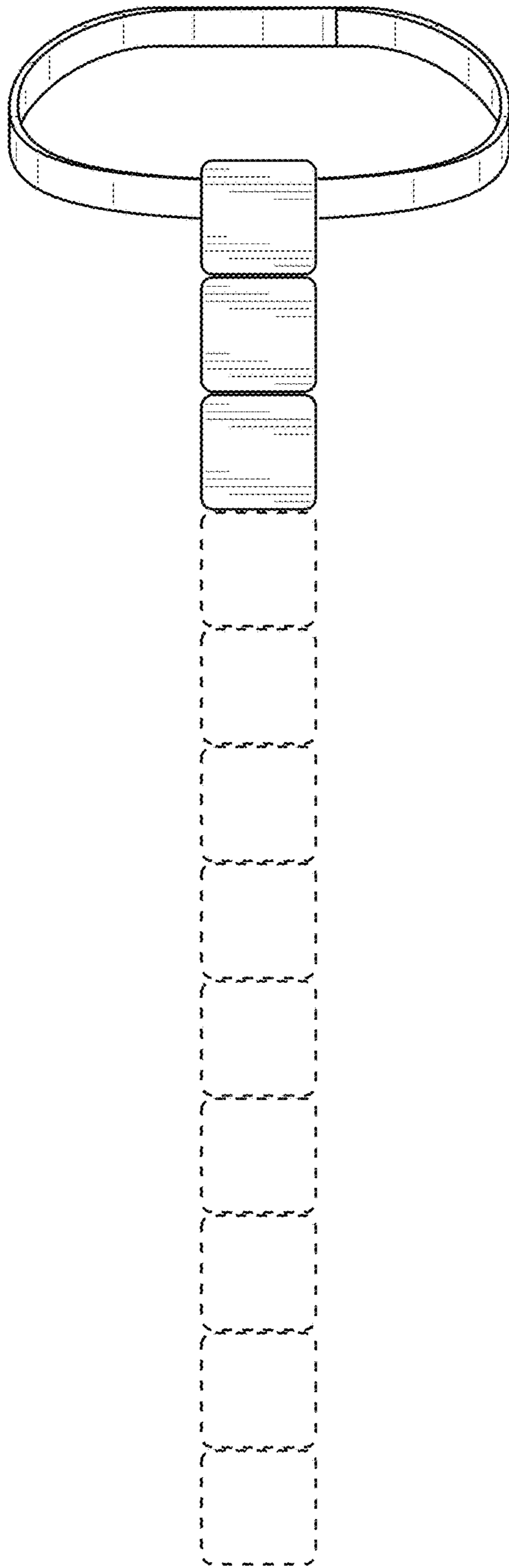

FIG. 41

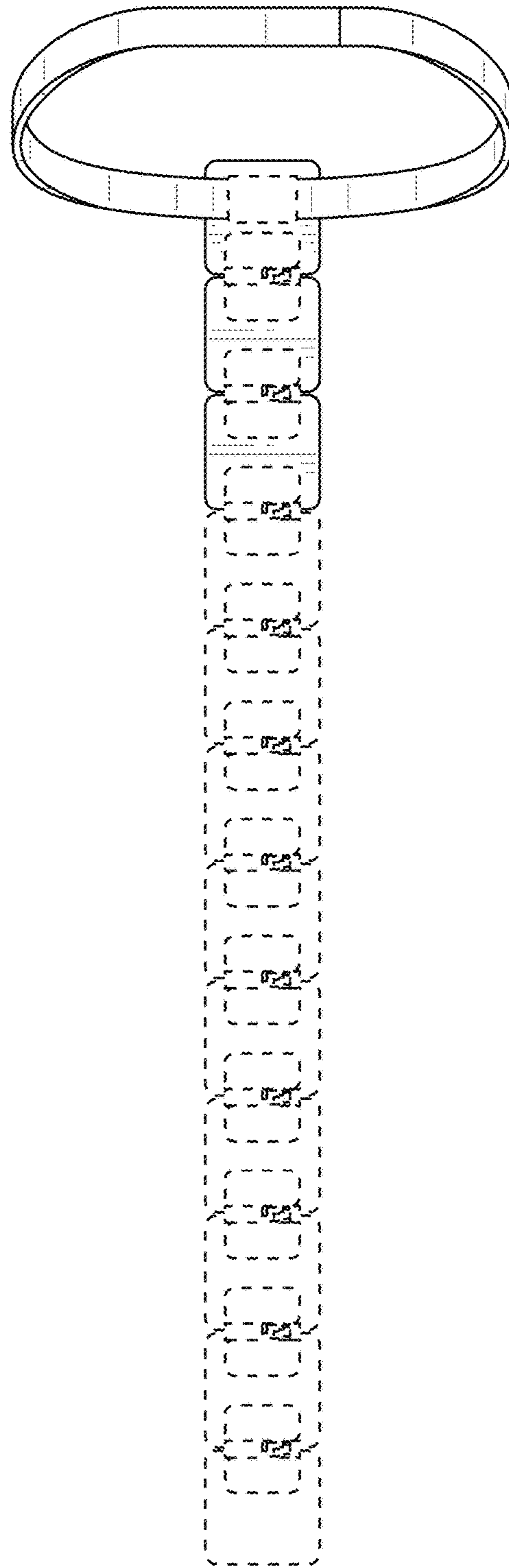

FIG. 42

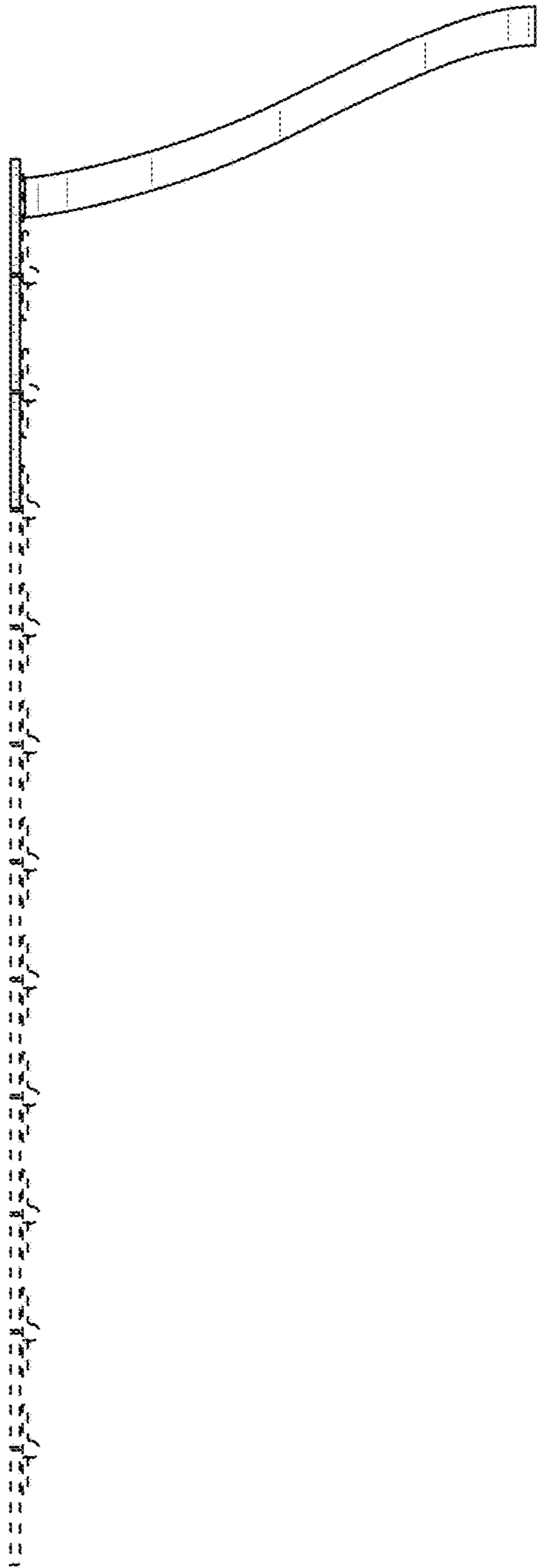

FIG. 43

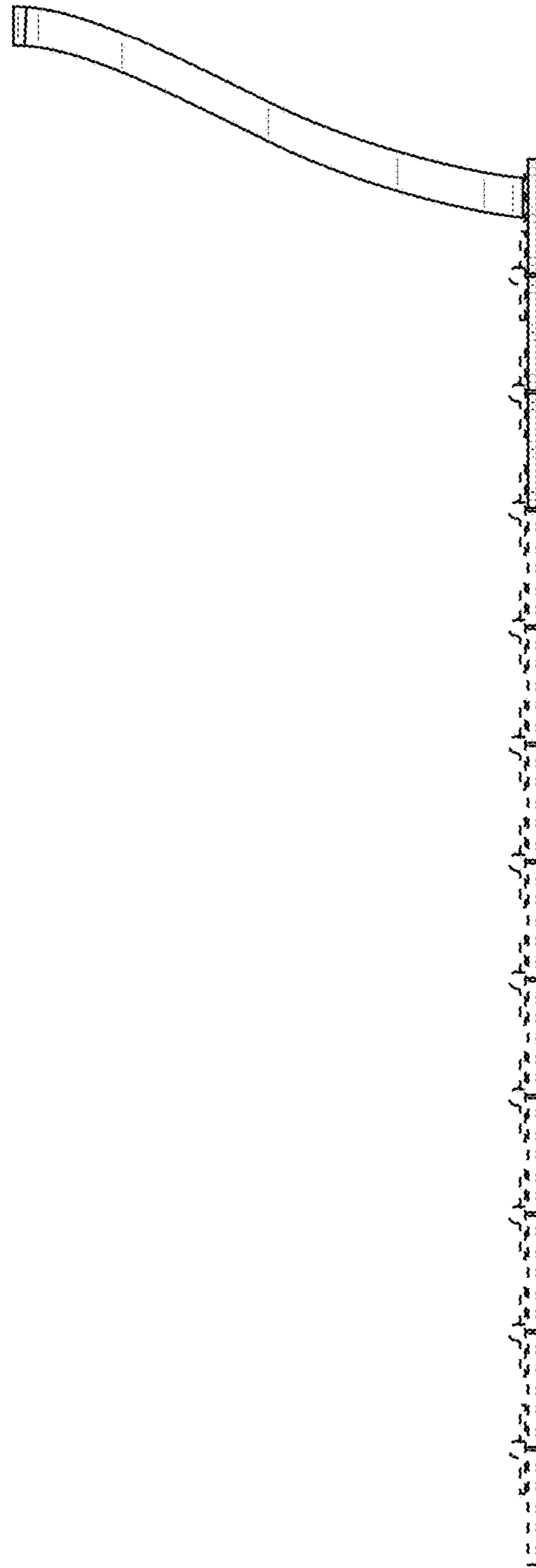

FIG. 44

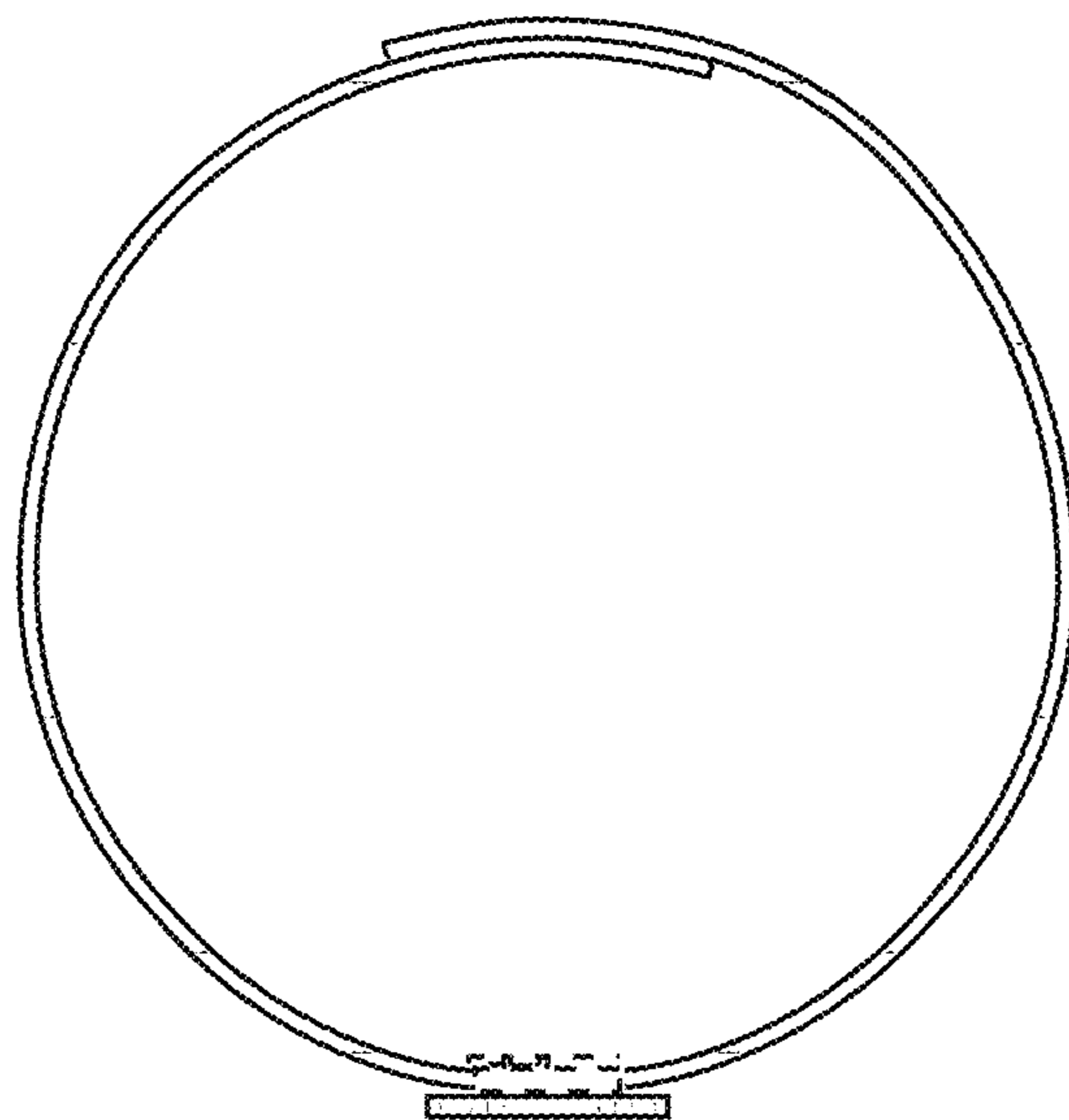

FIG. 45

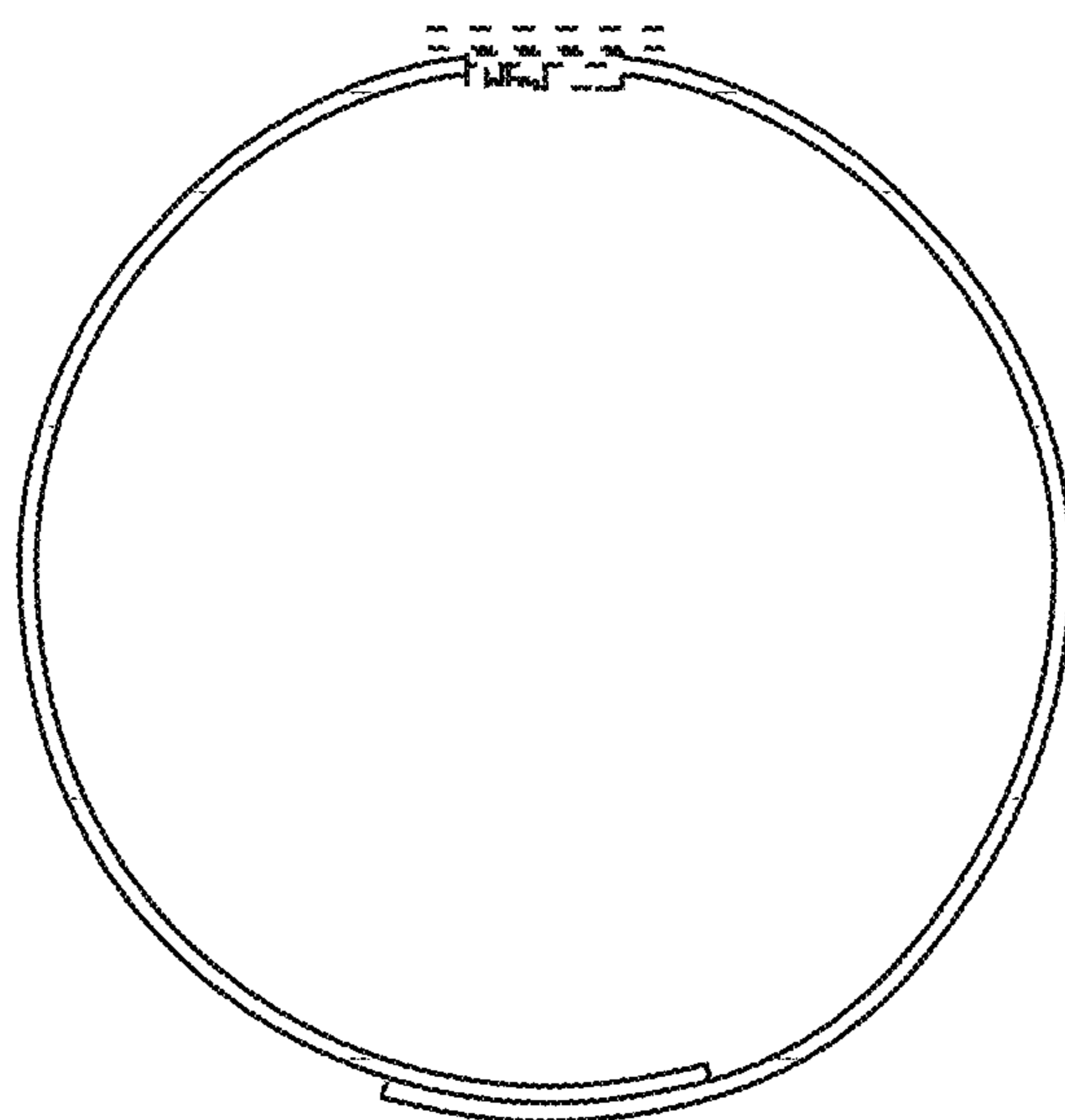

FIG. 46

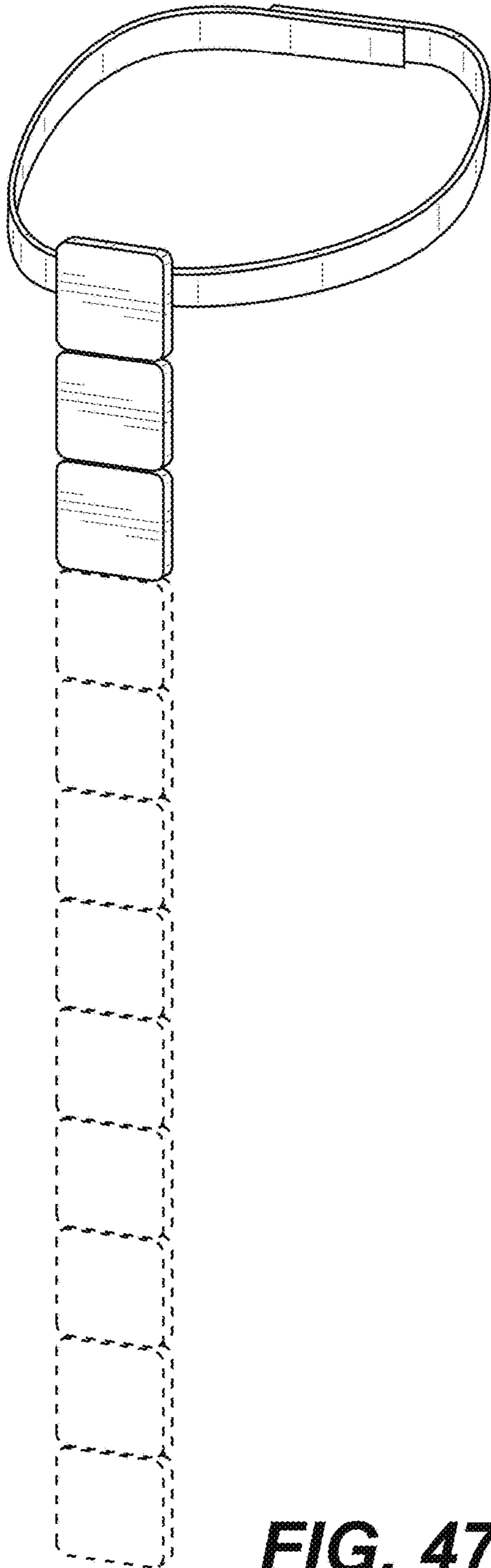

FIG. 47

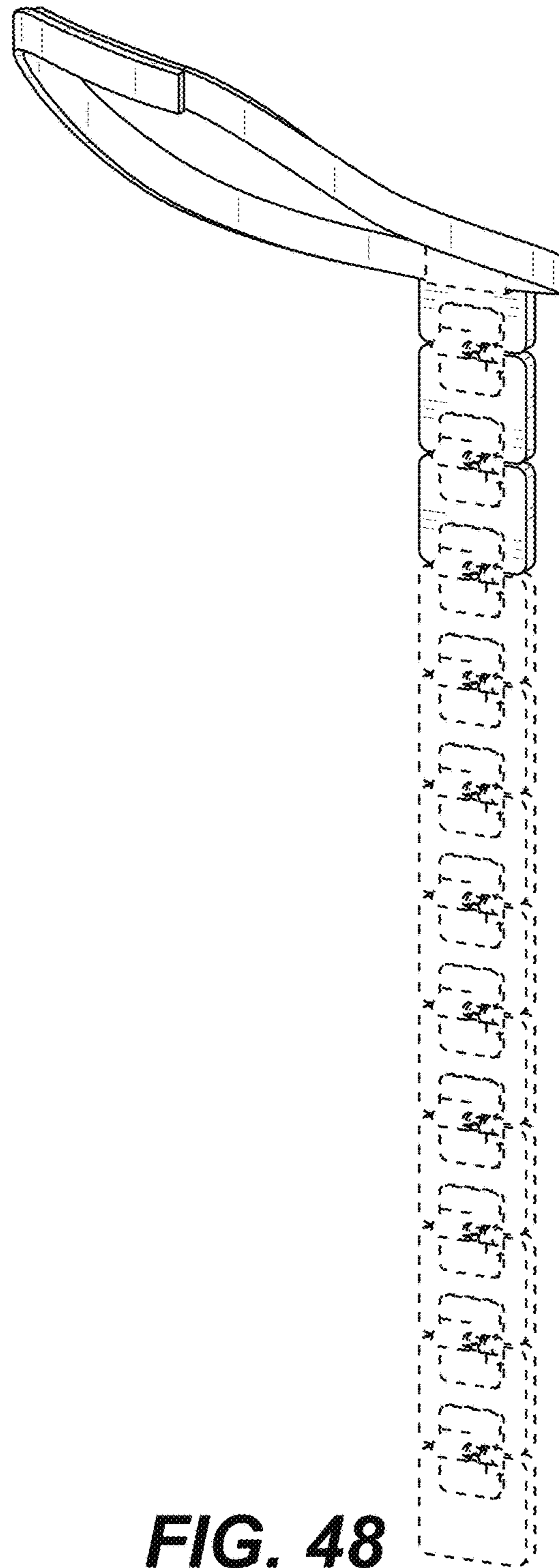

FIG. 48

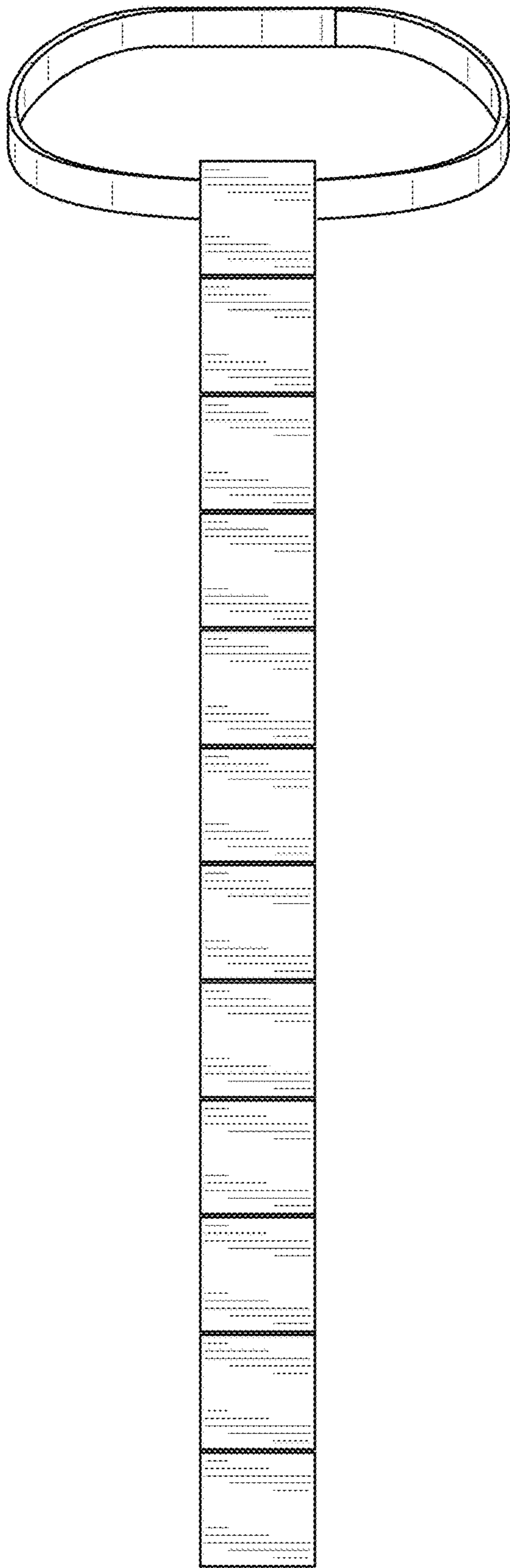

FIG. 49

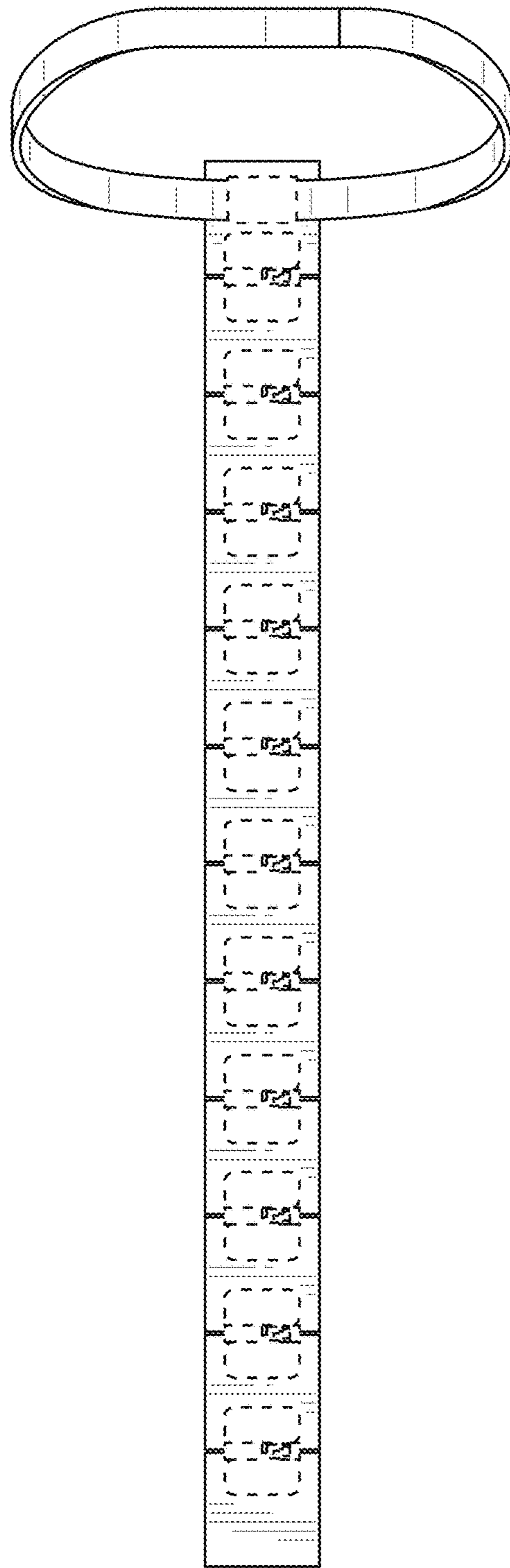

FIG. 50

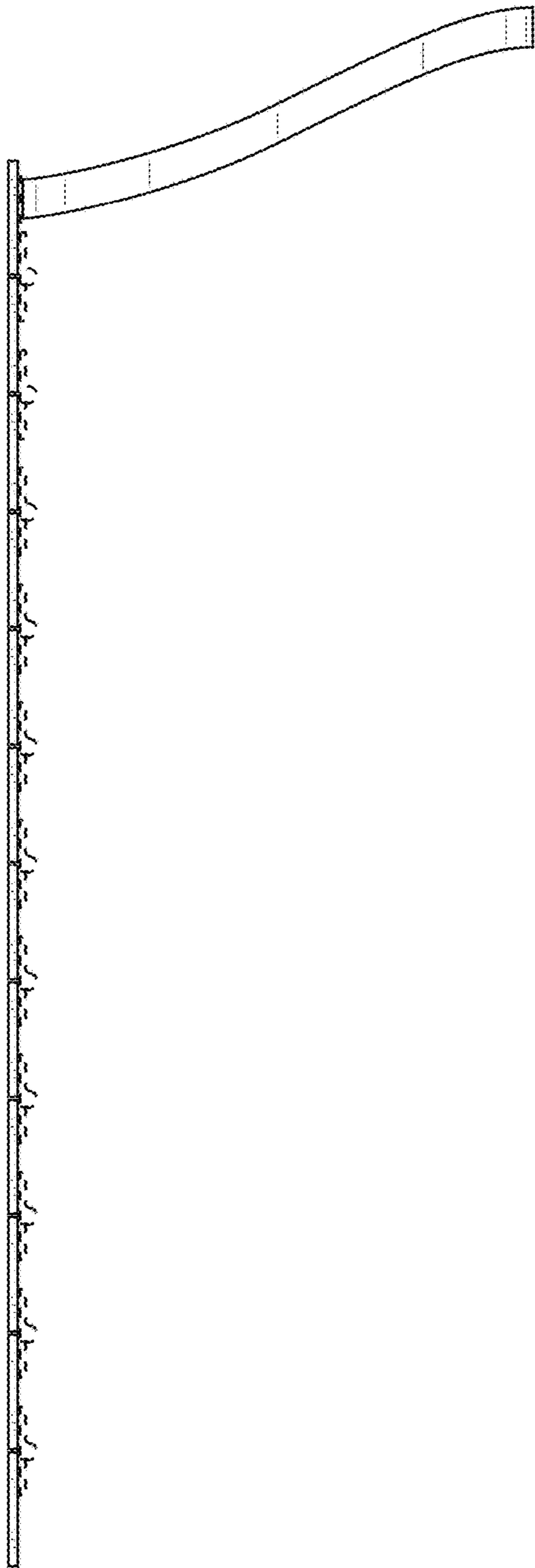

FIG. 51

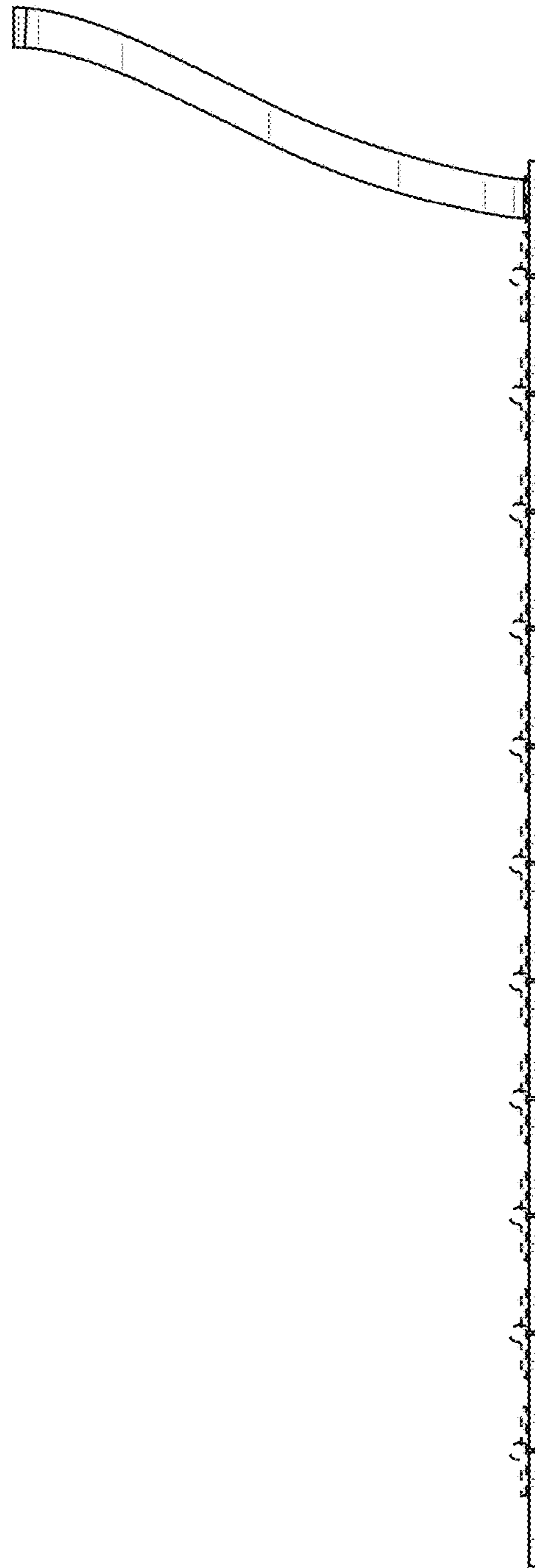

FIG. 52

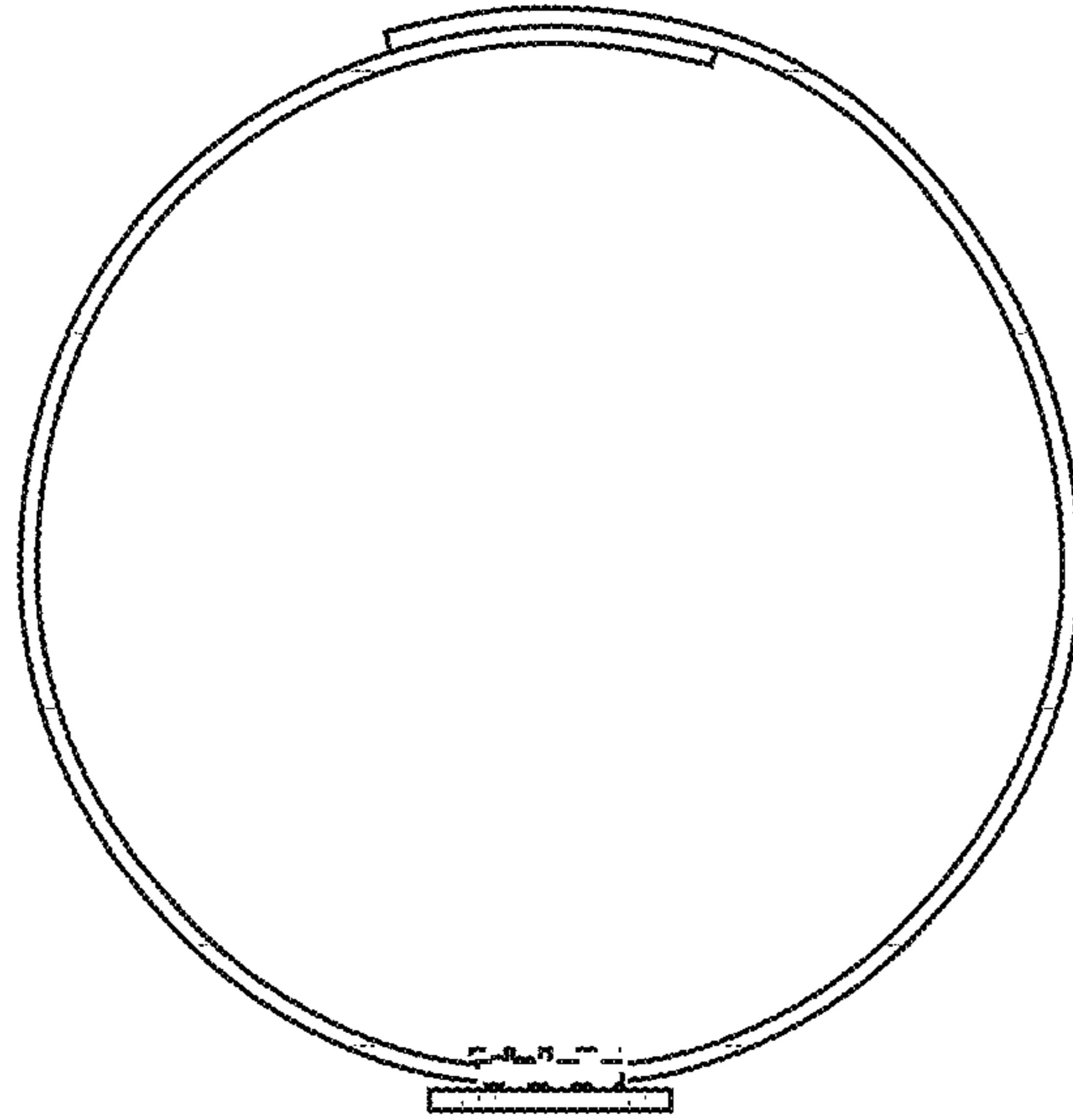

FIG. 53

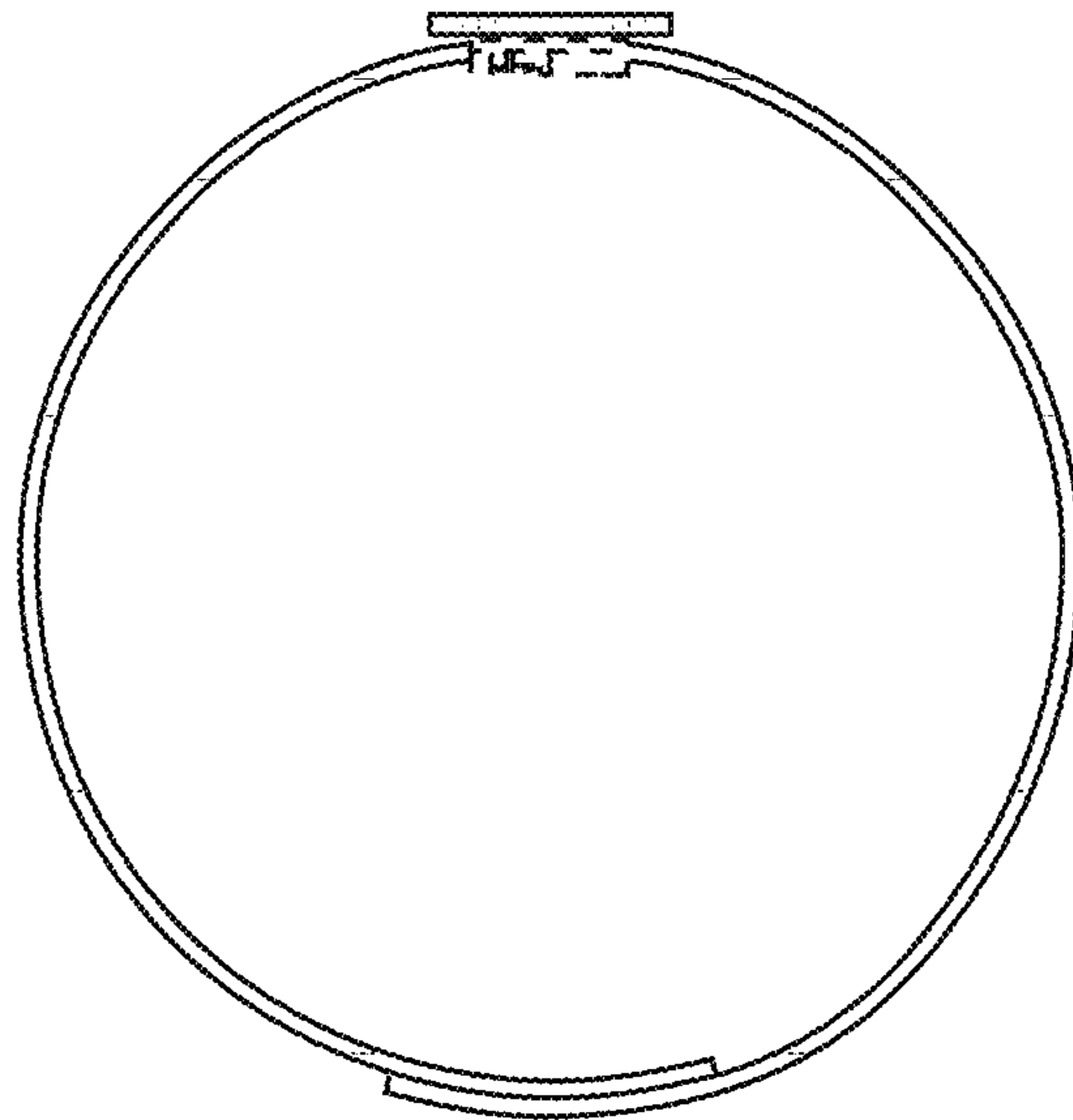

FIG. 54

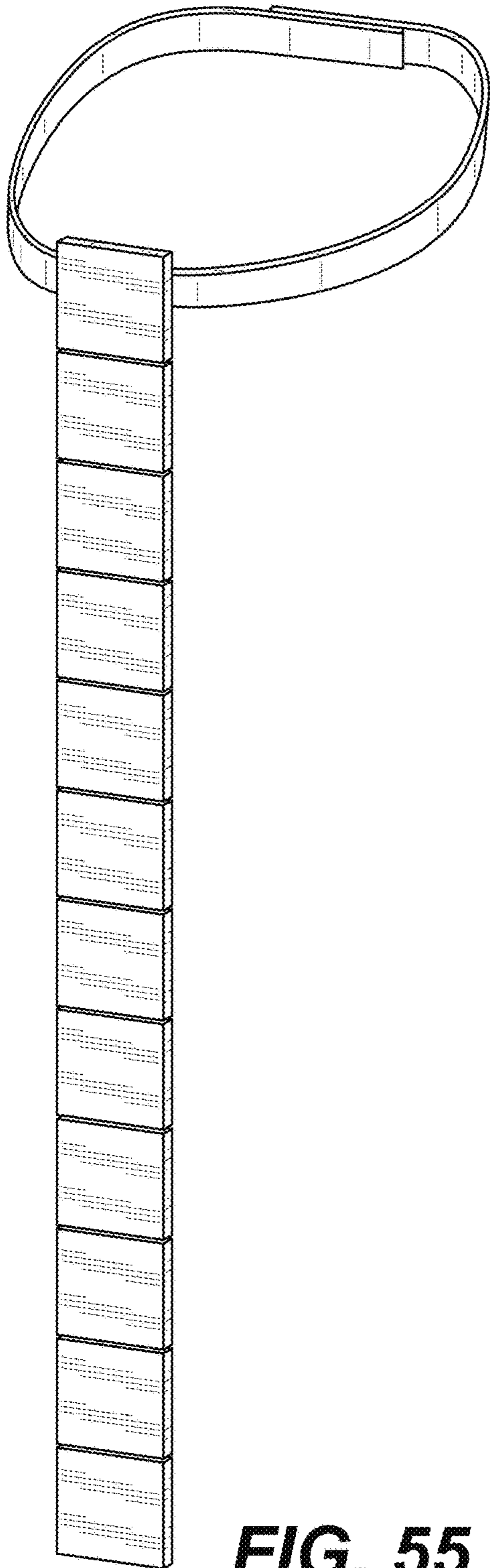

FIG. 55

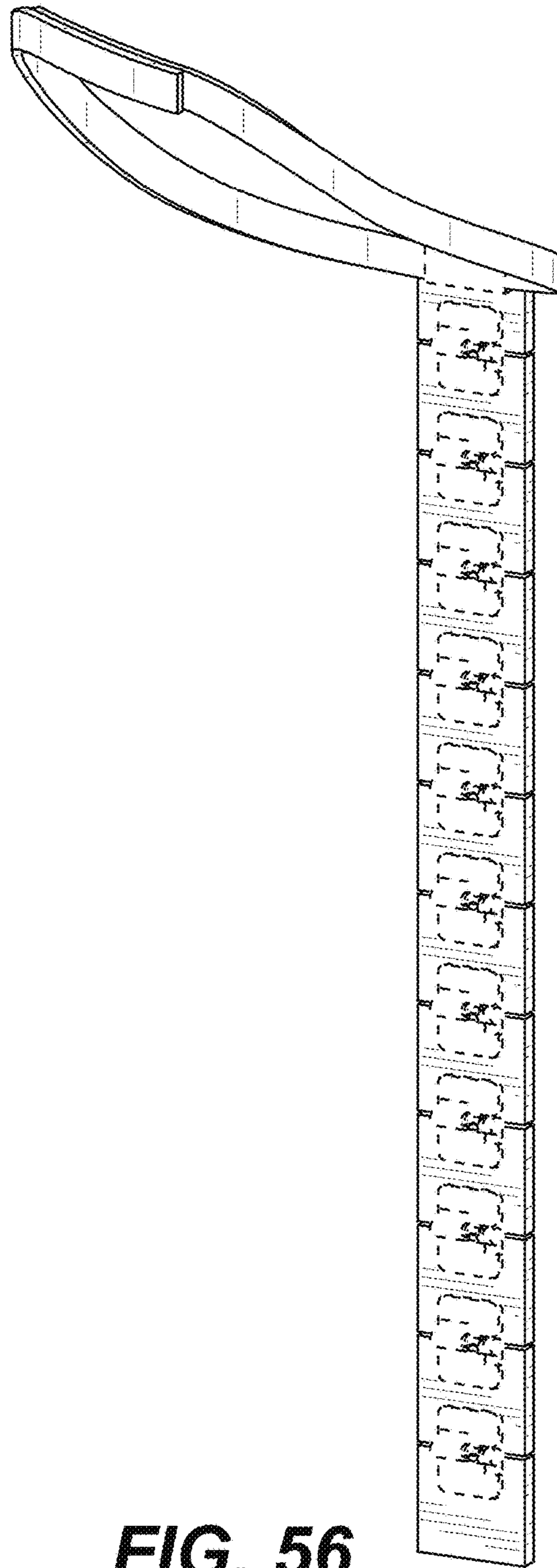

FIG. 56

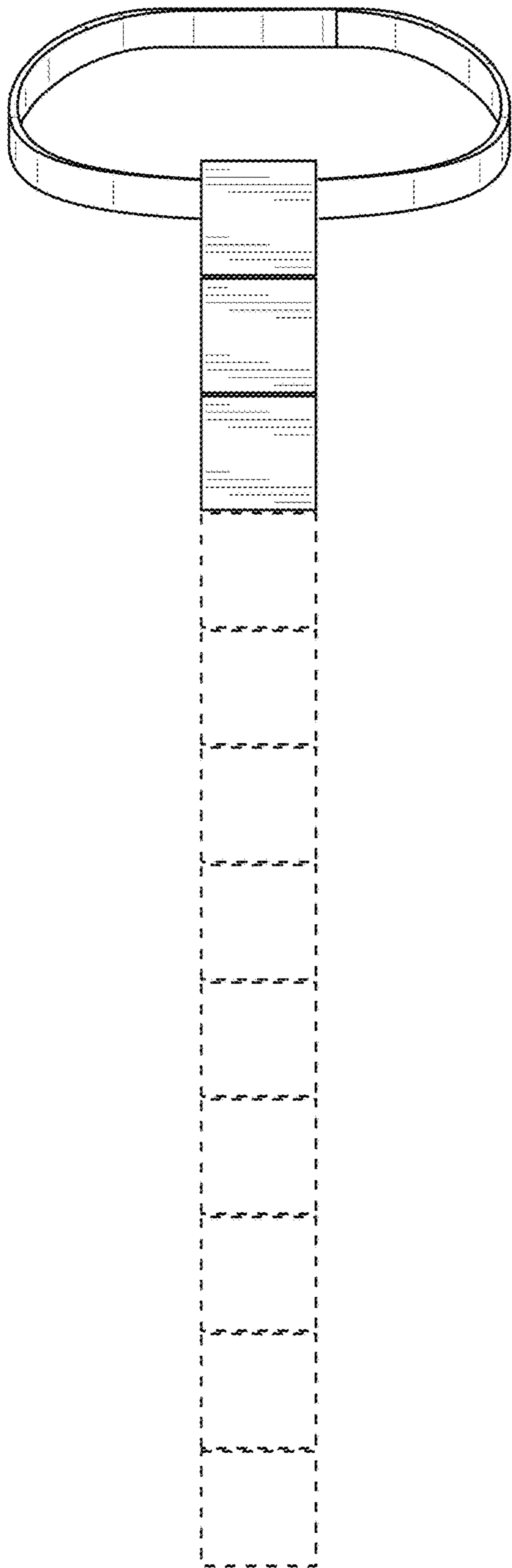

FIG. 57

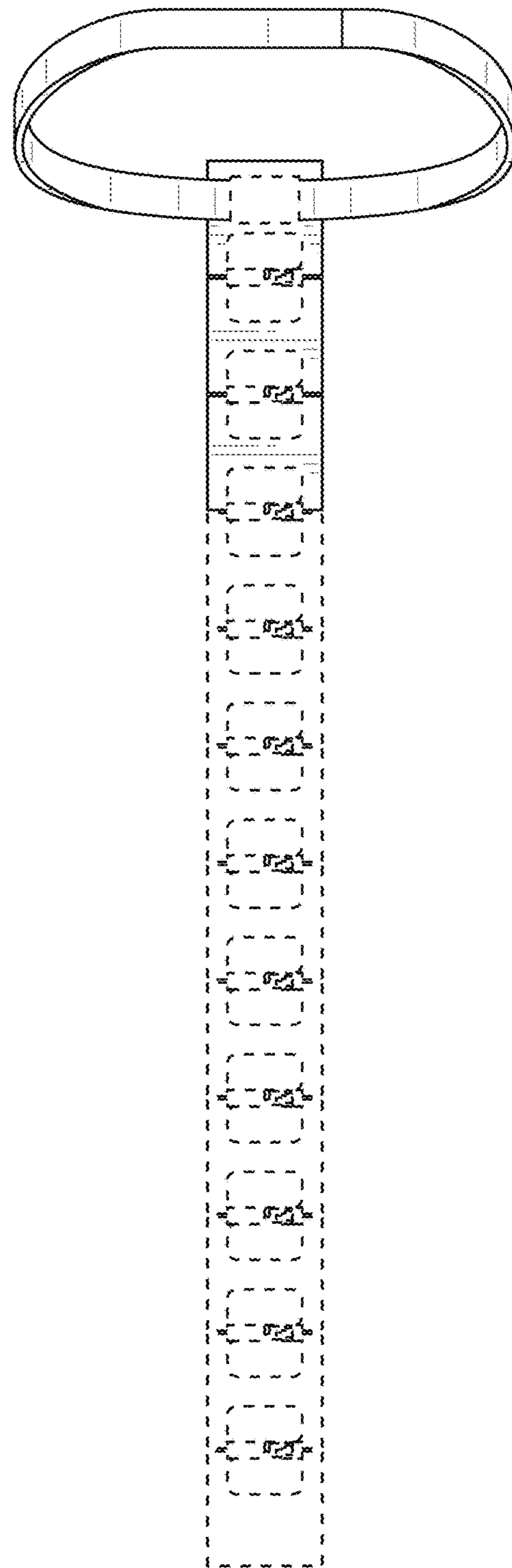

FIG. 58

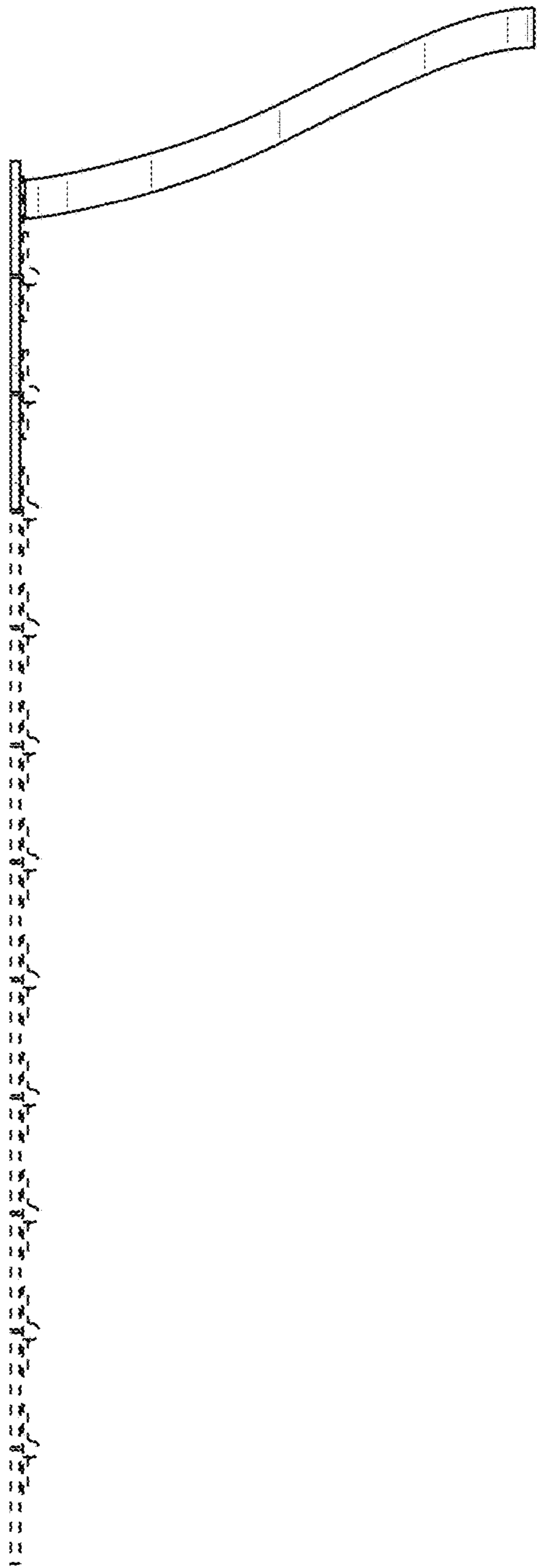

FIG. 59



FIG. 60

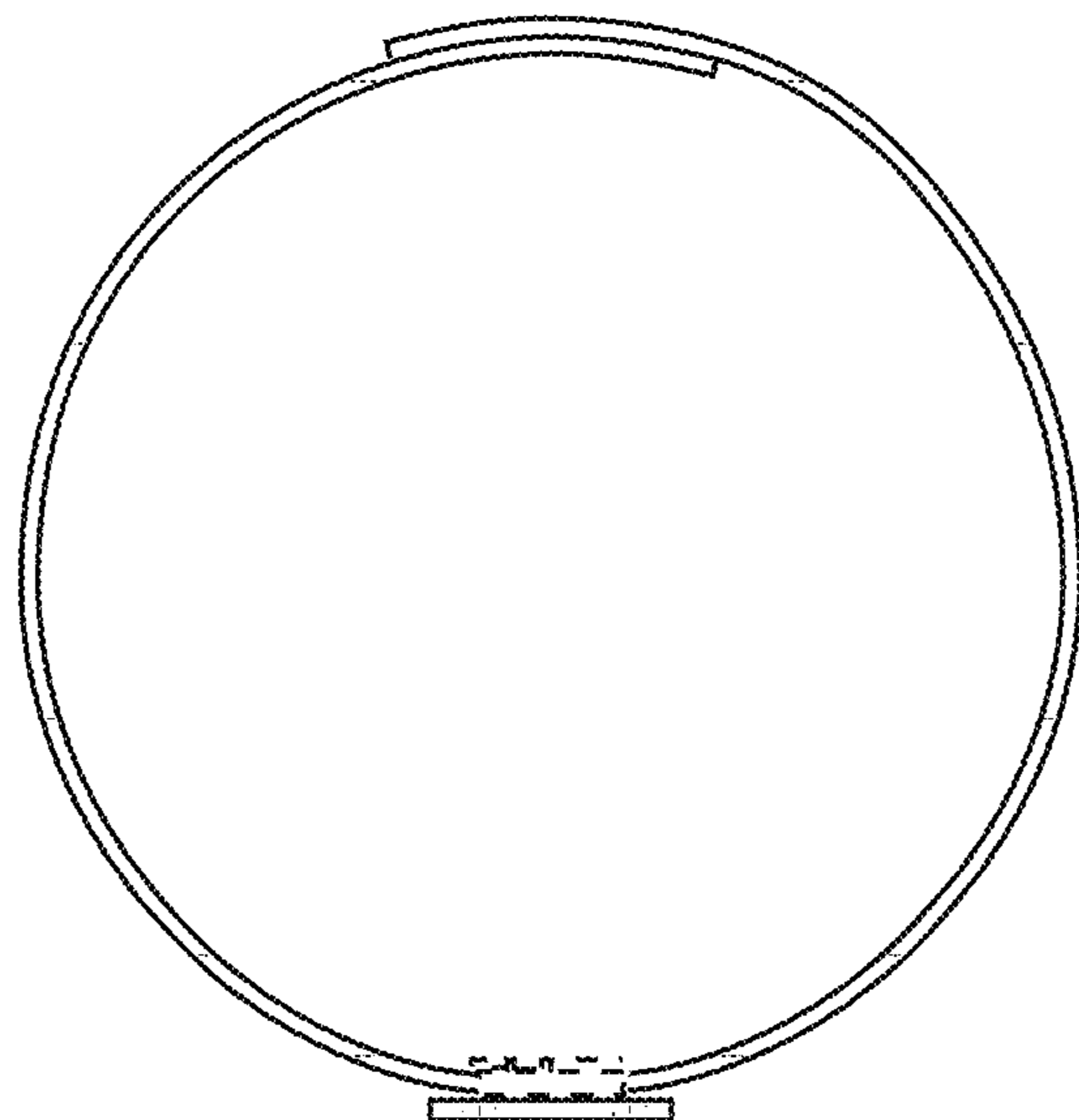

FIG. 61

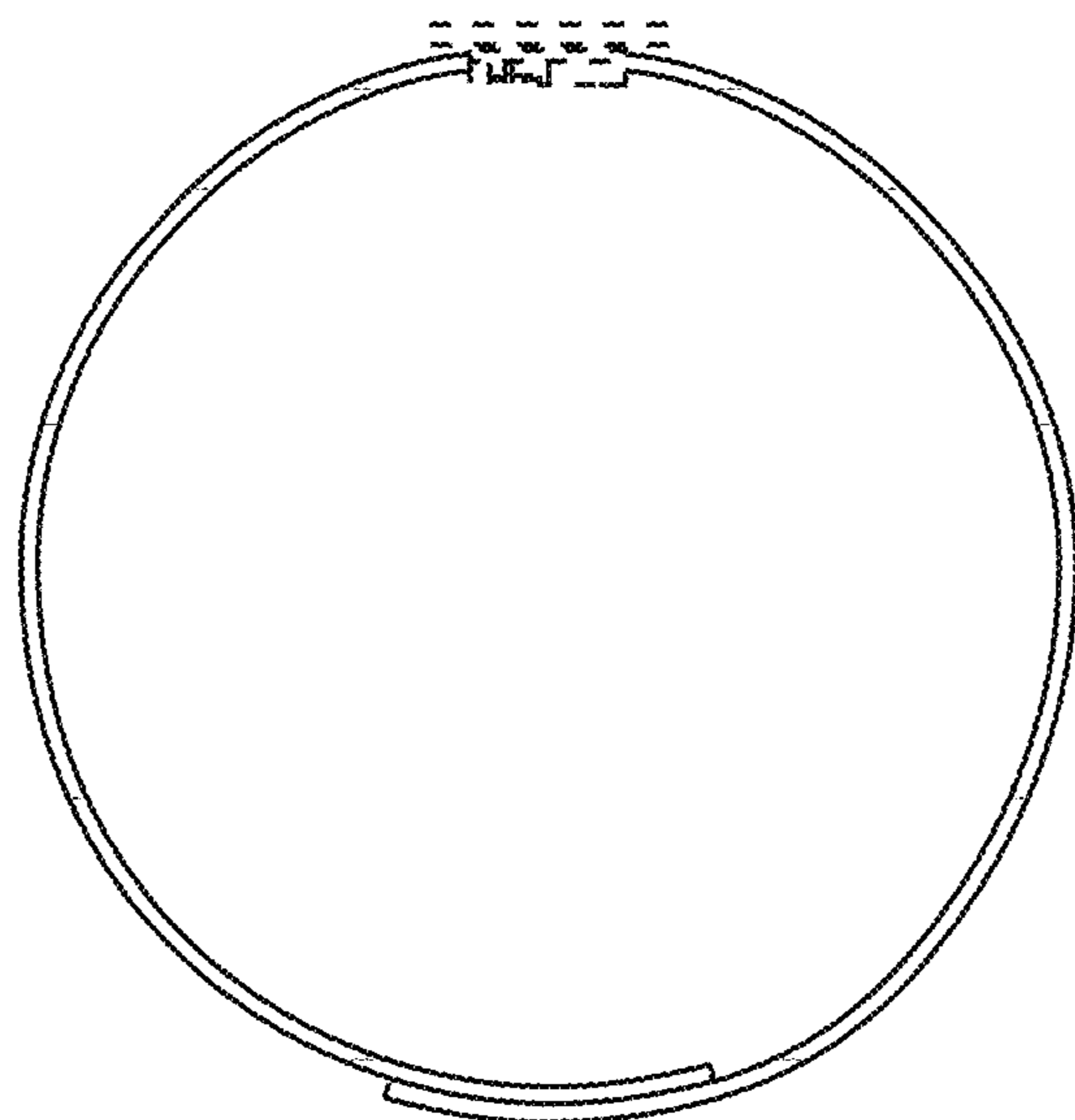

FIG. 62

