



US00D817589S

(12) **United States Design Patent** (10) **Patent No.:** **US D817,589 S**
Culbreth (45) **Date of Patent:** **** May 8, 2018**

- (54) **VAULT**
- (71) Applicant: **Vaultek Safe Inc.**, Orlando, FL (US)
- (72) Inventor: **Dustin Thomas Culbreth**, Savannah, GA (US)
- (73) Assignee: **Vaultek Safe Inc.**, Orlando, FL (US)
- (**) Term: **15 Years**
- (21) Appl. No.: **29/579,182**
- (22) Filed: **Sep. 28, 2016**
- (51) **LOC (11) Cl.** **06-04**
- (52) **U.S. Cl.**
USPC **D99/28**
- (58) **Field of Classification Search**
USPC D99/29, 34, 35, 36, 37, 38, 39, 40, 41, D99/42, 43, 28; D14/900, 901, 902, 307; 109/1 V; 232/4 R; D9/414, 423, 424, D9/432; D7/351; D3/273, 292, 304, D3/323, 201, 302, 294; D18/3.1, 3.2, D18/3.3; D8/334; D15/9.1, 9.2; D10/42; D25/16; D21/394; D27/189
CPC . B65D 45/16; B65D 1/00; B65D 1/22; B65D 7/00; B65D 7/06; G06Q 20/1085; A47B 43/00
See application file for complete search history.

- D627,967 S * 11/2010 Kuhls D3/273
- D732,264 S * 6/2015 Hine D99/28
- D749,846 S * 2/2016 Koeniger D3/294

OTHER PUBLICATIONS

Vaultek® Launch, Aug. 3, 2016, [online], [site visited Jul. 10, 2017]. Retrieved from url: <https://youtube.com/watch?v=TVUmFQg4HuA>.
Gunvault MicroVault XL MVB1000 gun safe Biometric fingerprint, Dec. 21, 2011, [site visited Jul. 10, 2017]. Retrieved from url: <https://www.amazon.com/product/dp/B006OGINCG/>.
“Instruction Manual: VT20i/VT10i,” vaulteksafe.com, downloaded Sep. 27, 2016, all enclosed pages cited.

* cited by examiner

Primary Examiner — Jeffrey D Asch
Assistant Examiner — Tracey J Bell

(74) *Attorney, Agent, or Firm* — Nelson Mullins Riley & Scarborough, LLP

(57) **CLAIM**

The ornamental design for a vault, substantially as shown and described.

DESCRIPTION

FIG. 1 is a front perspective view of a vault embodying the design of the present invention.
FIG. 2 is a right side elevational view of the vault illustrated in FIG. 1.
FIG. 3 is a left side elevational view of the vault illustrated in FIG. 1.
FIG. 4 is a rear side elevational view of the vault illustrated in FIG. 1.
FIG. 5 is a front side elevational view of the vault illustrated in FIG. 1.
FIG. 6 is a top view of the vault illustrated in FIG. 1; and, FIG. 7 is a bottom view of the vault illustrated in FIG. 1.
The portions shown in broken lines form no part of the claimed design.

1 Claim, 5 Drawing Sheets

(56) **References Cited**

U.S. PATENT DOCUMENTS

- D291,139 S * 7/1987 Warwicker D3/281
- D447,634 S * 9/2001 Snider D3/273
- D474,596 S * 5/2003 Osiecki D3/273
- D487,192 S * 3/2004 Farnham D3/294
- D489,158 S * 4/2004 Magee D99/28
- D496,495 S * 9/2004 Jeffers D28/73
- D518,640 S * 4/2006 Hoofnagle D3/273
- D528,735 S * 9/2006 Osiecki D99/43
- D552,352 S * 10/2007 Lin D3/294
- D616,200 S * 5/2010 Riedel D3/281

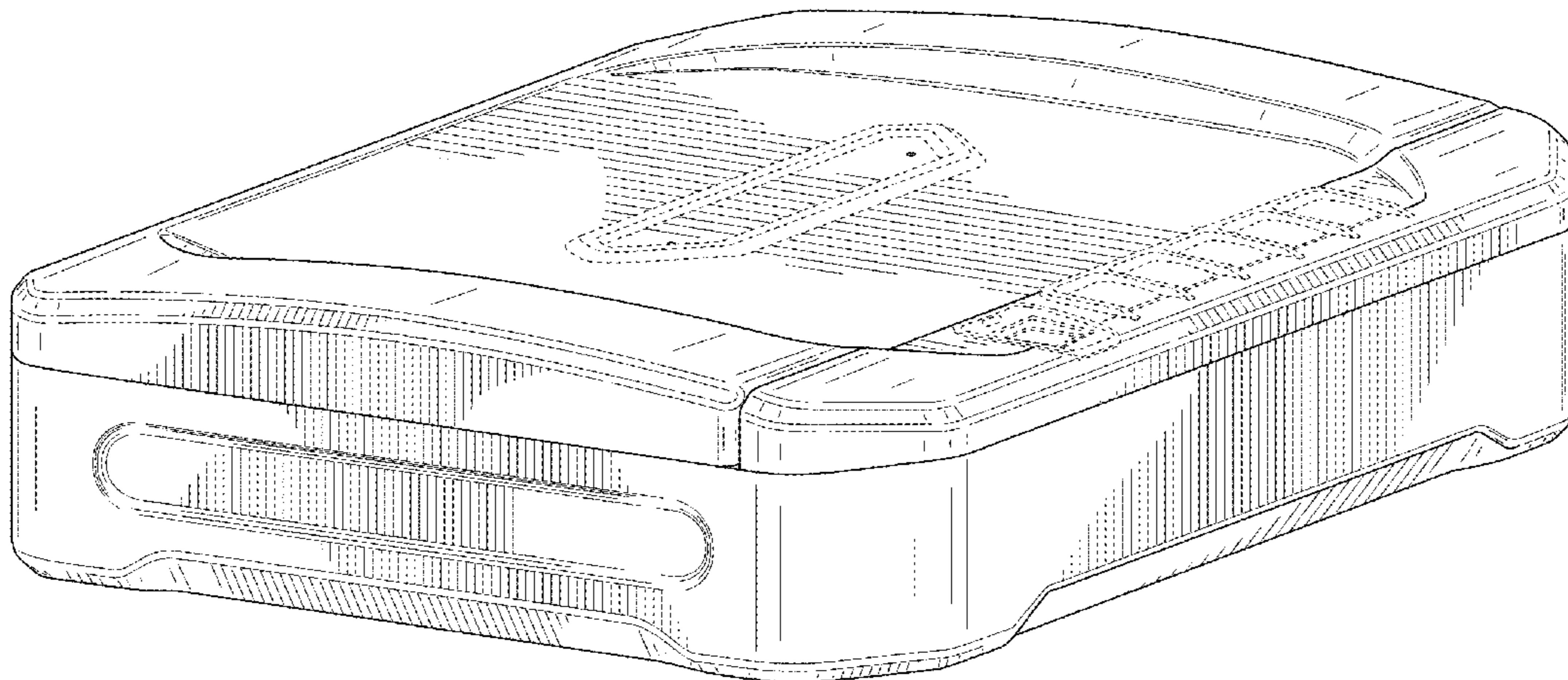

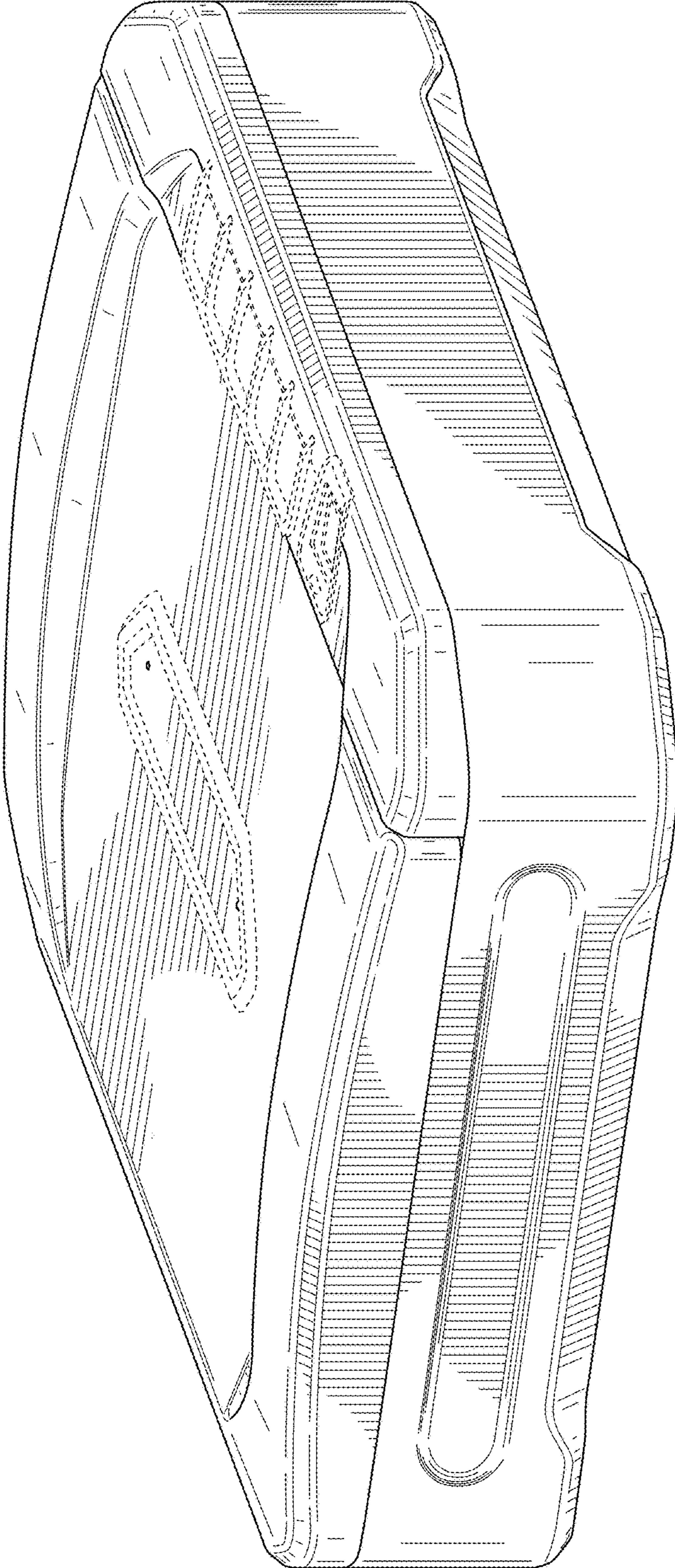

FIG. 1

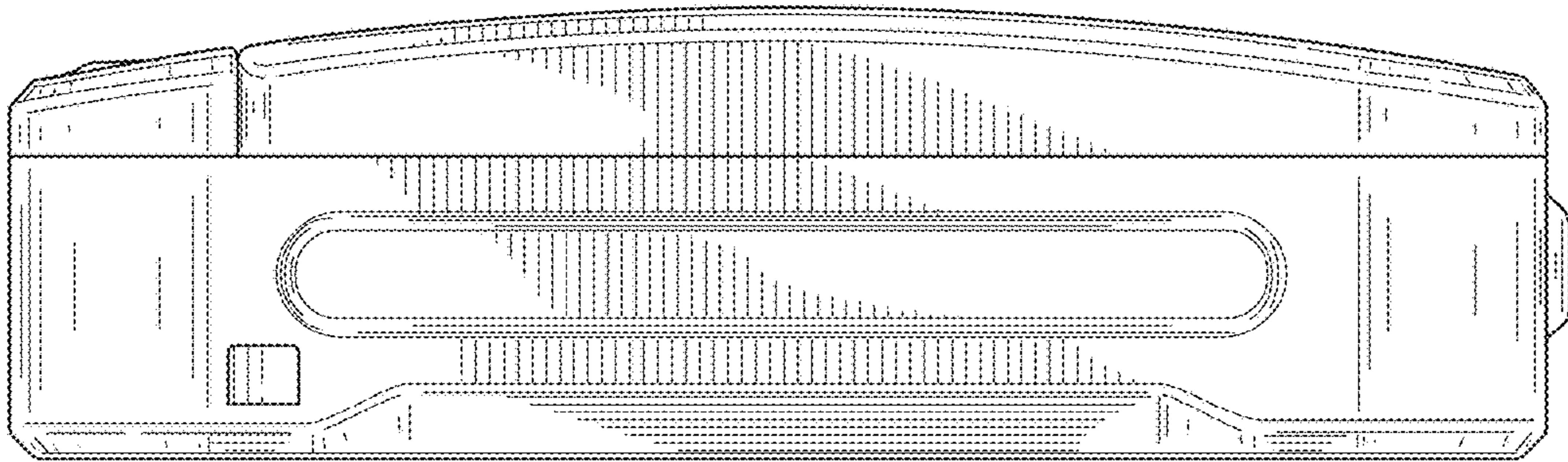

FIG. 2

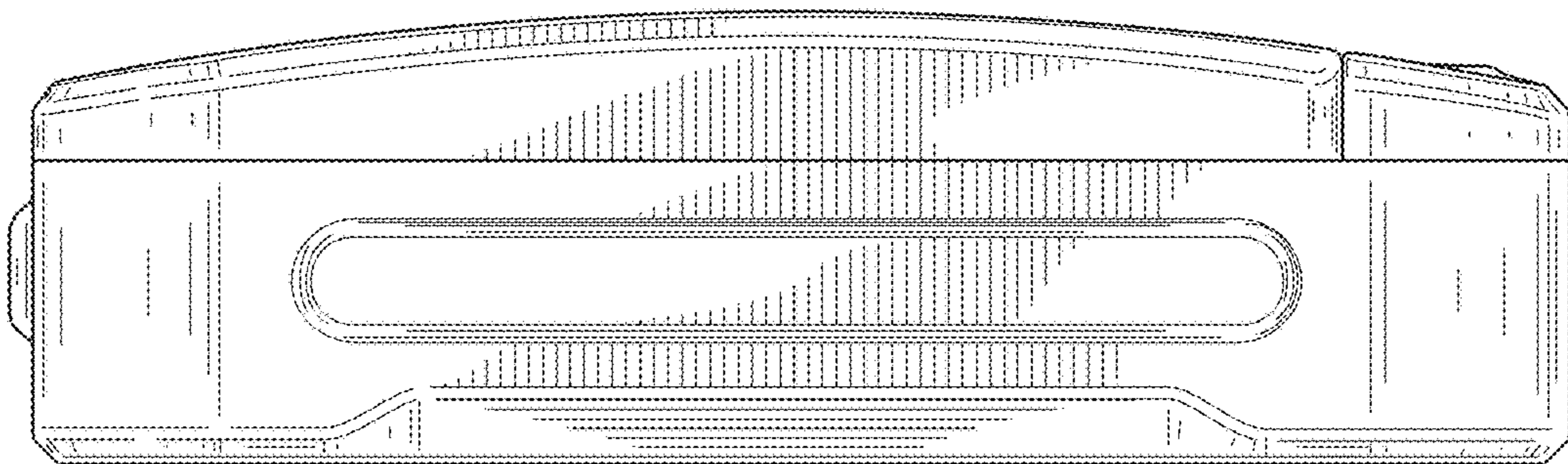

FIG. 3

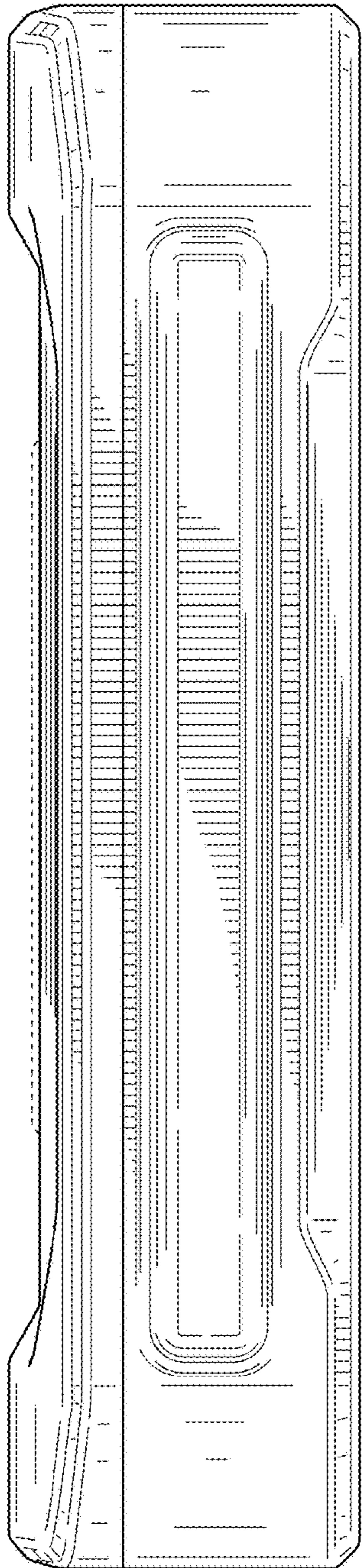

FIG. 4

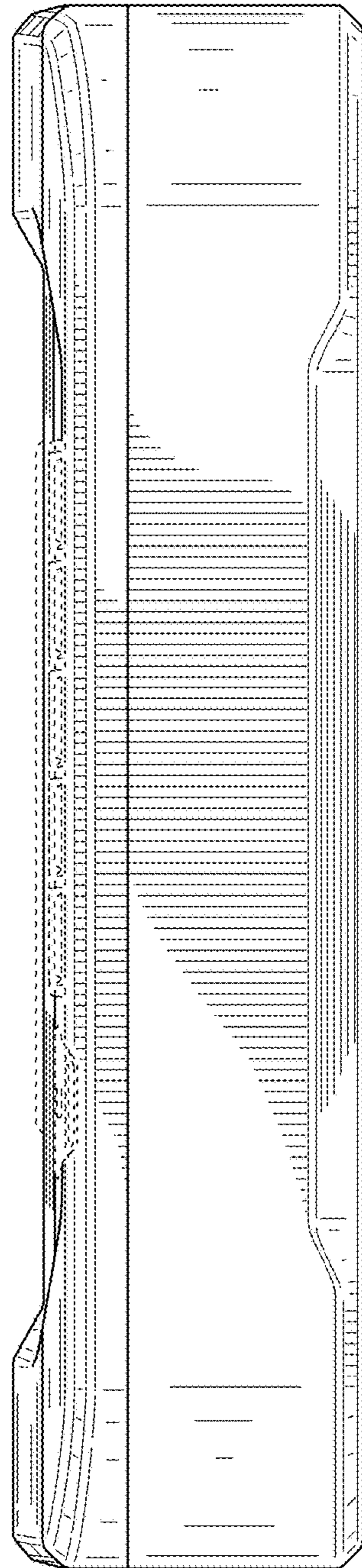

FIG. 5

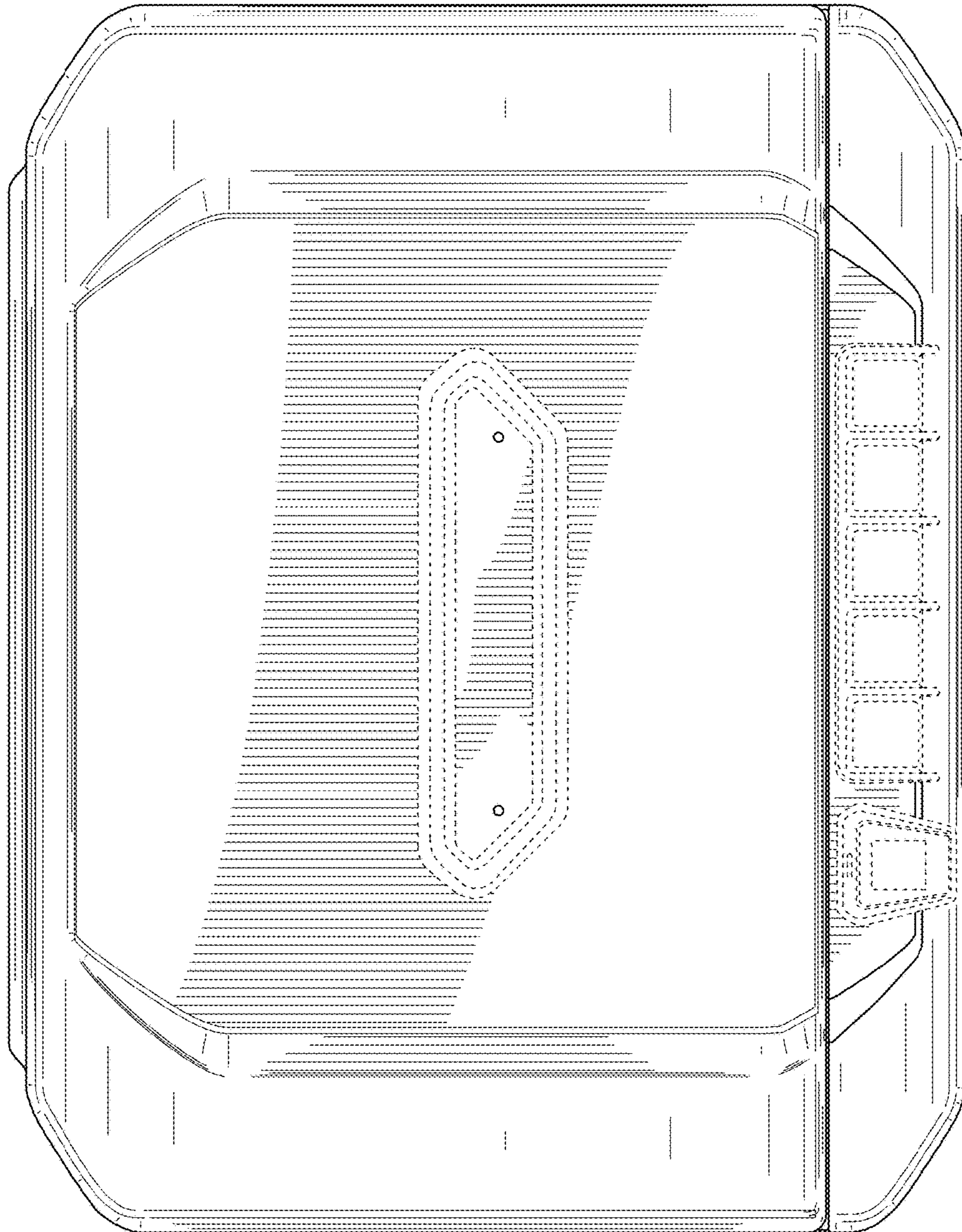

FIG. 6

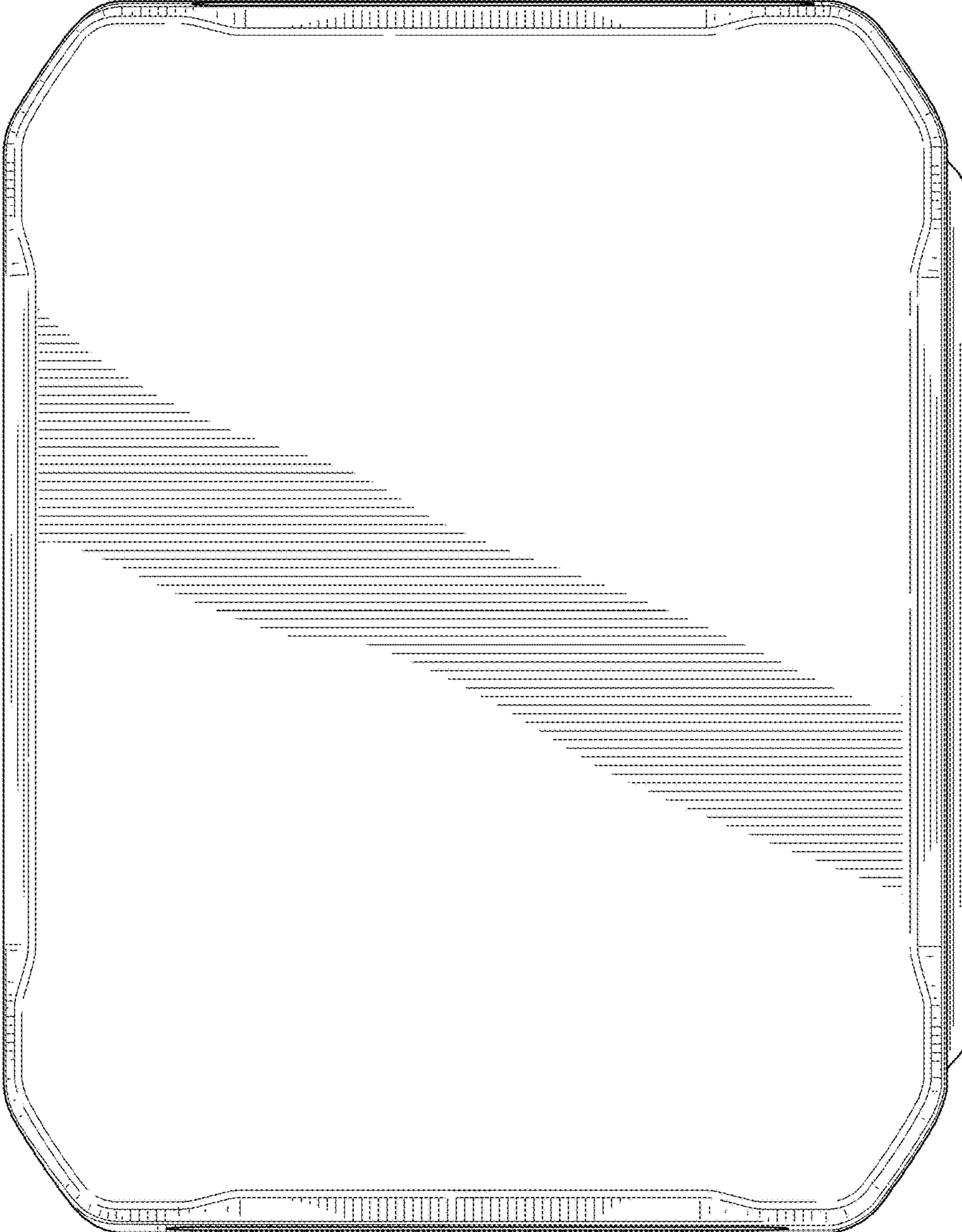

FIG. 7