



US00D817545S

(12) **United States Design Patent**
Castellano et al.

(10) **Patent No.:** **US D817,545 S**
(45) **Date of Patent:** **** May 8, 2018**

(54) **FACIAL MAKE-UP APPLICATOR**

(71) Applicant: **Tokiwa Corp.**, Tokyo (JP)

(72) Inventors: **Michele F. Castellano**, West Harrison, NY (US); **Thomas Van Dyk**, Ramsey, NJ (US)

(73) Assignee: **Tokiwa Corp.**, Tokyo (JP)

(**) Term: **15 Years**

(21) Appl. No.: **29/555,867**

(22) Filed: **Feb. 25, 2016**

(51) **LOC (11) Cl.** **28-02**

(52) **U.S. Cl.**
USPC **D28/7**

(58) **Field of Classification Search**
USPC D28/7, 44, 46, 50, 52, 55-57, 99, 76-77, D28/82, 85, 68; D24/170, 176, 232, 181; D4/116, 118-119, 122, 127, 132, 135; D19/108, 125, 123, 159, 115, 158, 163; D21/181; D30/162; D3/7, 9; D8/72, 73
CPC A45D 34/041; A45D 2/22; A45D 2/2471; A45D 26/0066; A45D 26/0071; A45D 29/004; A45D 29/007; A45D 29/04; A45D 34/045; A45D 34/042; A45D 34/04; A45D 33/36; A45D 33/12; A45D 29/16; A45D 29/12; A45D 34/06; A45D 40/00; A45D 33/00; A45D 40/02; A45D 40/065; A45D 40/20; A45D 40/205; A45D 40/06; A45D 40/16; A45D 40/28; A61K 8/02; A61K 9/00; A61B 17/24
See application file for complete search history.

(56) **References Cited**

U.S. PATENT DOCUMENTS

D190,333 S * 5/1961 Gunderson D21/795
3,467,100 A * 9/1969 Rubin A61B 17/1604
606/84

3,871,392 A * 3/1975 Thomas A61C 15/046
132/323
D288,824 S * 3/1987 Ijiri D19/123
D296,459 S * 6/1988 Johnson D22/150
4,828,418 A * 5/1989 Sauer A61F 4/00
173/30
D327,910 S * 7/1992 Cantlon 401/195
D354,689 S * 1/1995 Figard 401/195
D412,043 S * 7/1999 Dolan D28/68
D420,768 S * 2/2000 Garofano D28/25
D424,748 S * 5/2000 Dolan D28/68
D425,668 S * 5/2000 Garofano D28/7
D448,082 S * 9/2001 Blank D24/152
D450,371 S * 11/2001 Liao D19/108
6,637,962 B1 * 10/2003 Roche B43K 5/005
16/430
D531,758 S * 11/2006 Jansheski D28/68

(Continued)

Primary Examiner — Shannon W Morgan

(74) *Attorney, Agent, or Firm* — Richard M. Goldberg

(57) **CLAIM**

The ornamental design for a facial make-up applicator, as shown and described.

DESCRIPTION

FIG. 1 is a perspective view of the facial make-up applicator of our design;
FIG. 2 is a rear elevational view thereof;
FIG. 3 is a top plan view thereof;
FIG. 4 is a right side elevational view thereof, with the left side elevational view being a mirror image thereof;
FIG. 5 is a bottom plan view thereof;
FIG. 6 is a front elevational view thereof;
FIG. 7 is an exploded, perspective view thereof; and,
FIG. 8 is a perspective view thereof with the cap removed for ease of illustration.
The broken lines shown in FIG. 8 represent environmental subject matter and form no part of the claimed design.

1 Claim, 5 Drawing Sheets

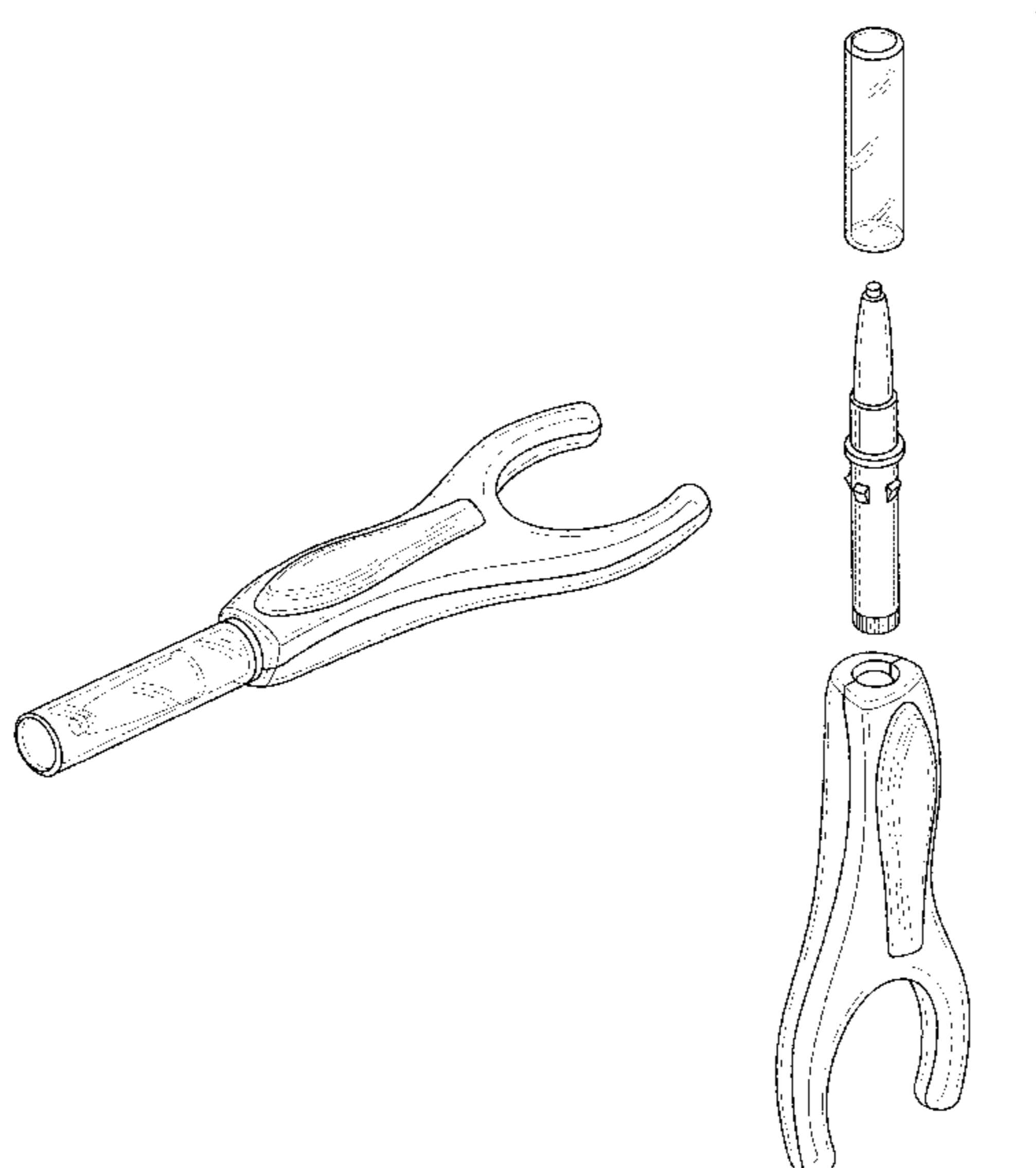

(56)

References Cited

U.S. PATENT DOCUMENTS

D533,965 S * 12/2006 Chodorow D28/68
D624,703 S * 9/2010 Misner D28/68
D662,098 S * 6/2012 Leto D14/411
D726,376 S * 4/2015 Stofko D28/68
D734,556 S * 7/2015 Brett D24/181
2006/0042650 A1* 3/2006 Ochs A61C 15/00
132/323
2011/0222952 A1* 9/2011 Gueret A45D 34/042
401/8
2012/0027497 A1* 2/2012 Huang A46B 9/021
401/16

* cited by examiner

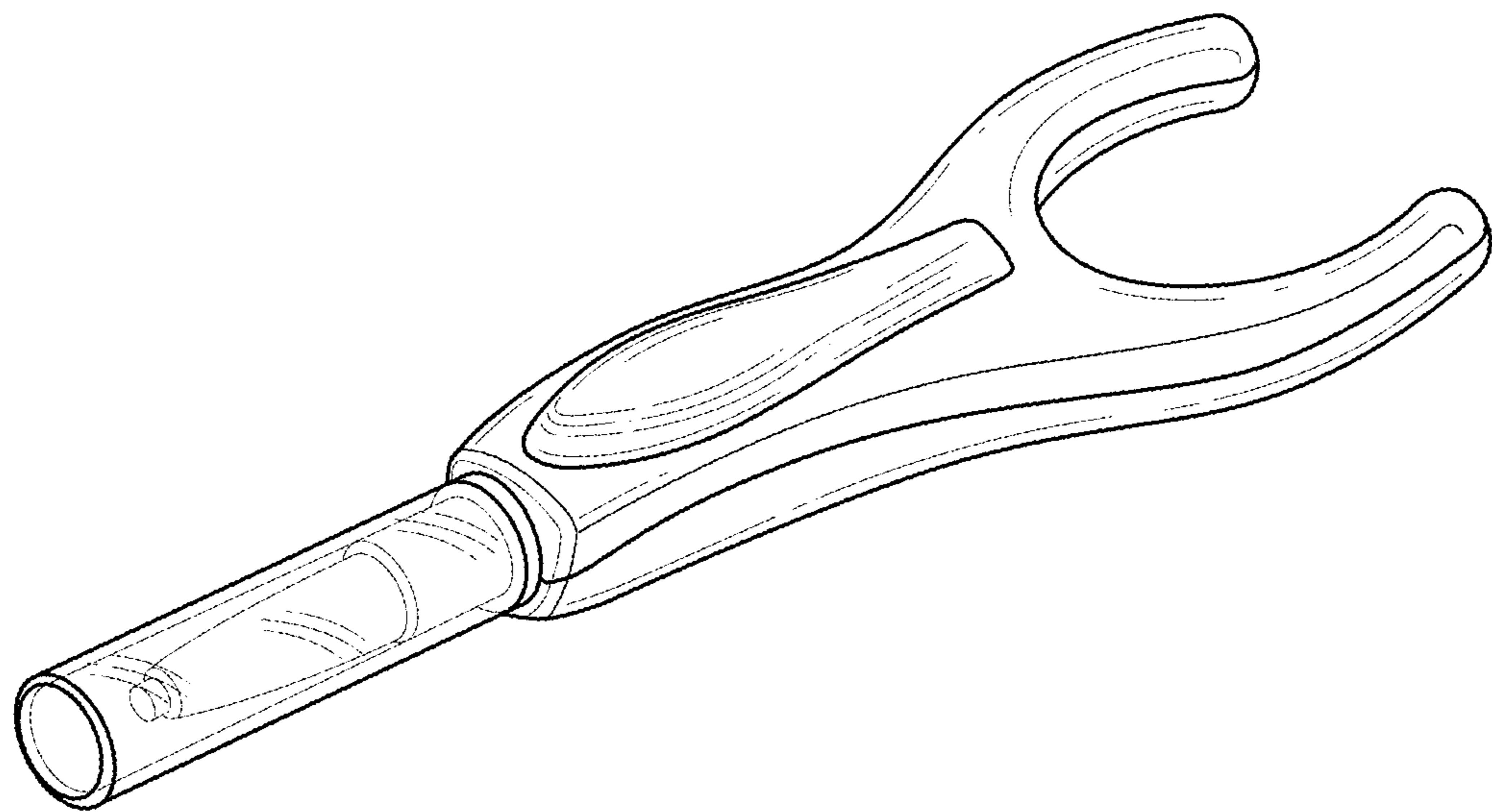

FIG. 1

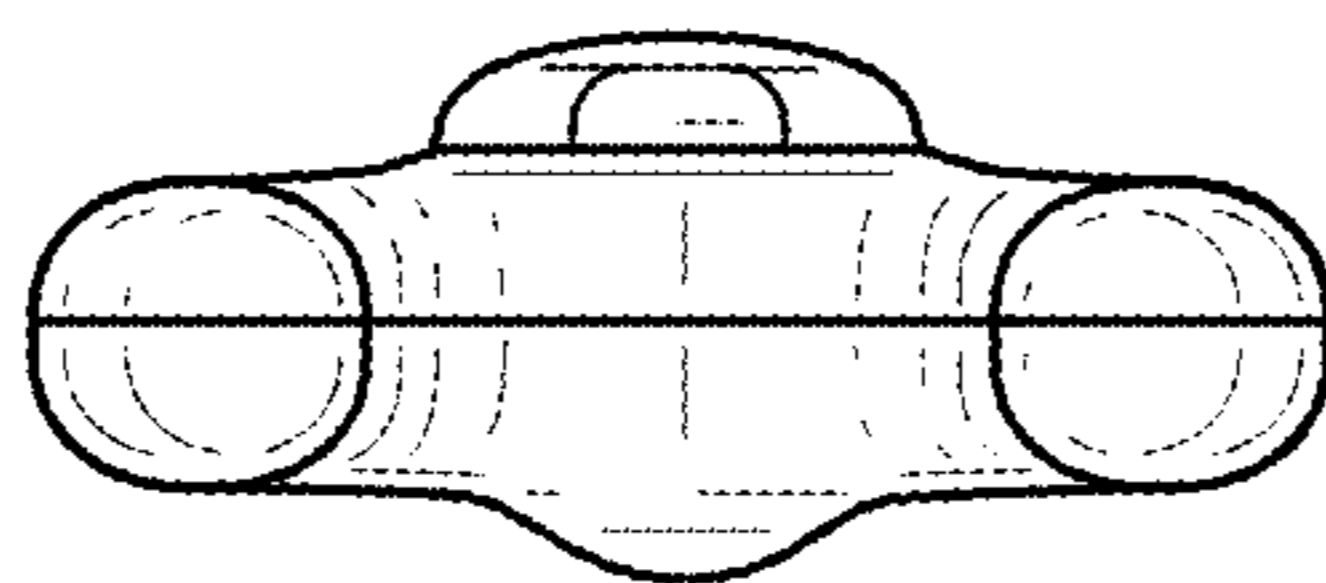

FIG. 2

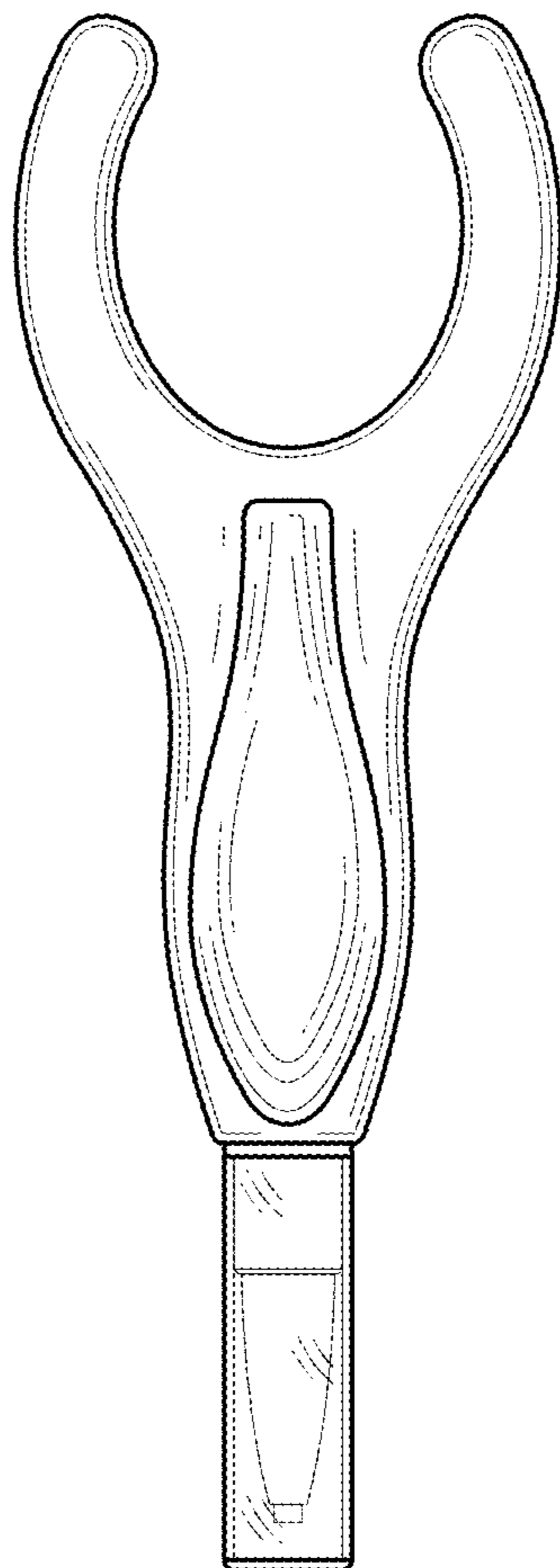

FIG. 3

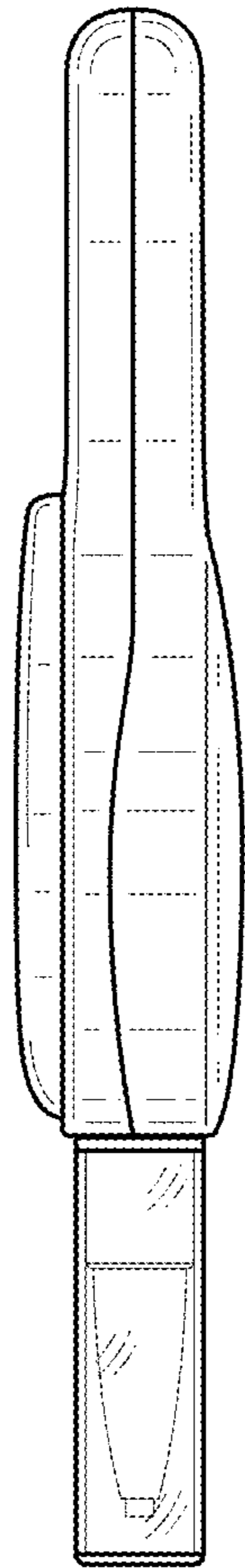

FIG. 4

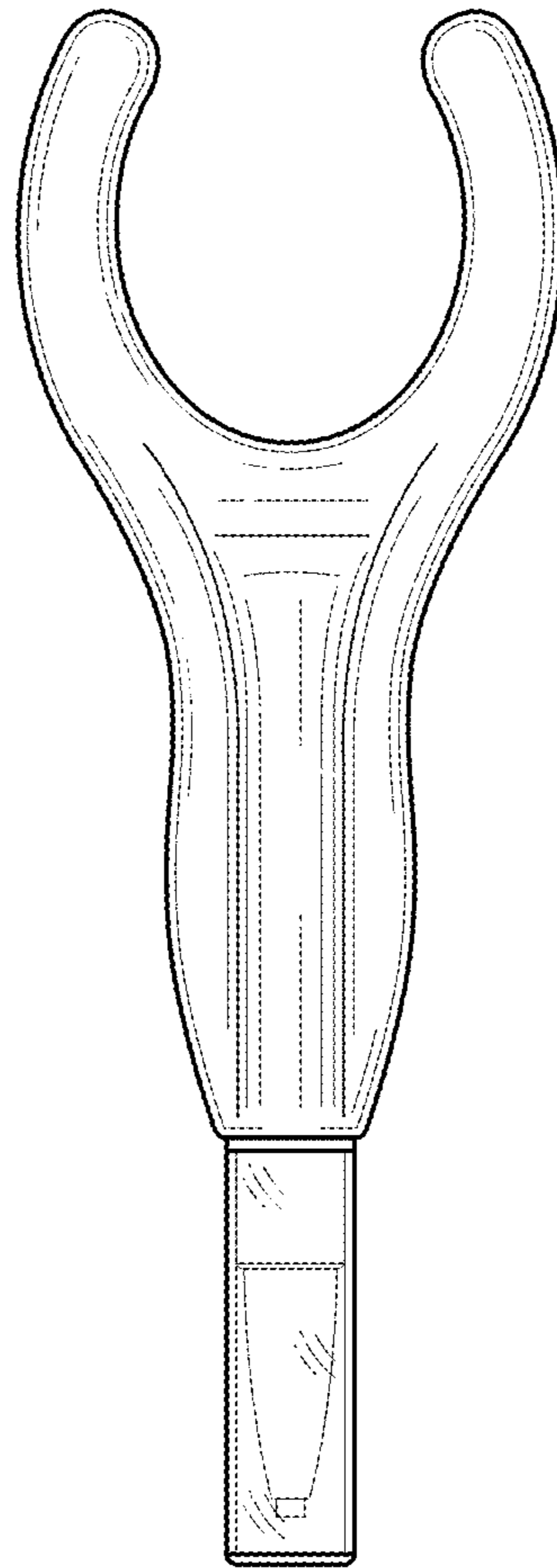

FIG. 5

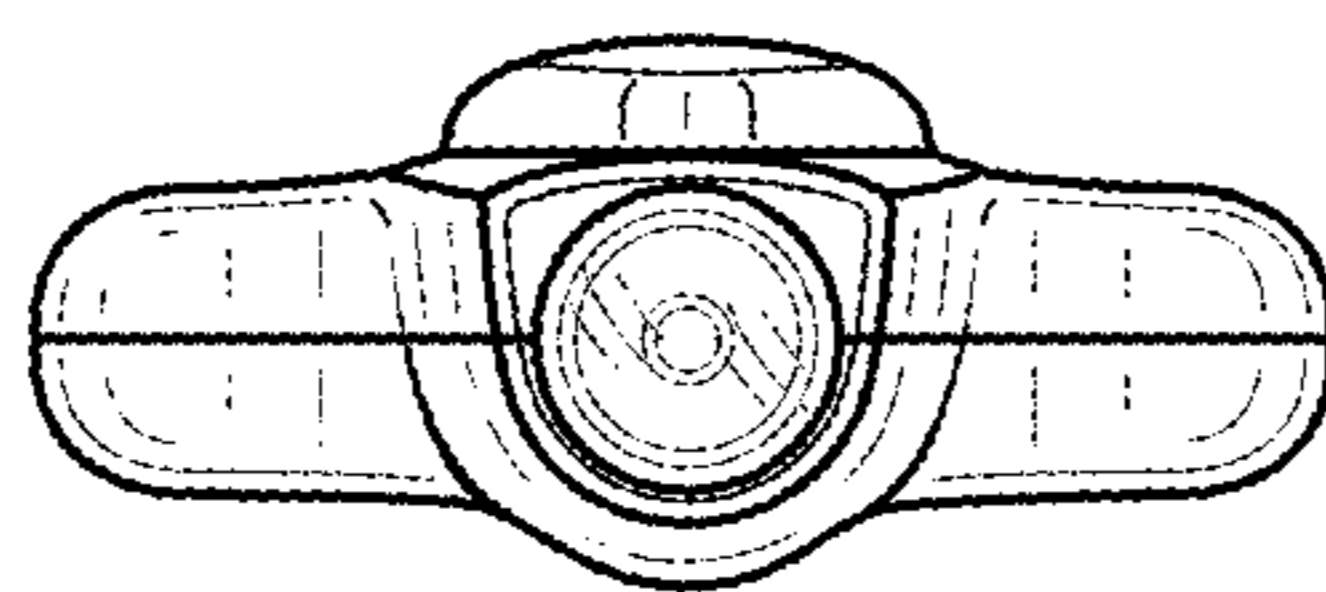

FIG. 6

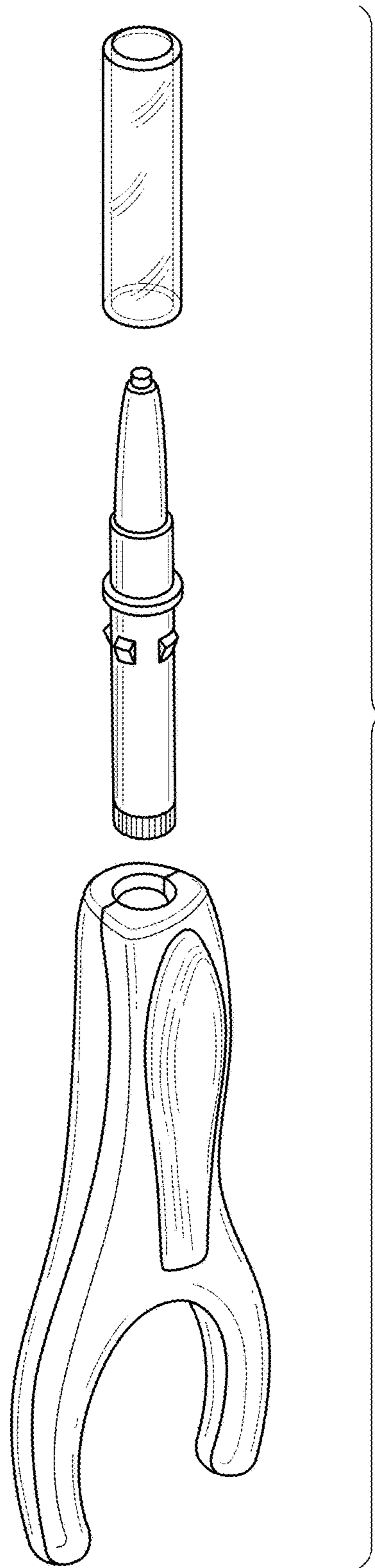

FIG. 7

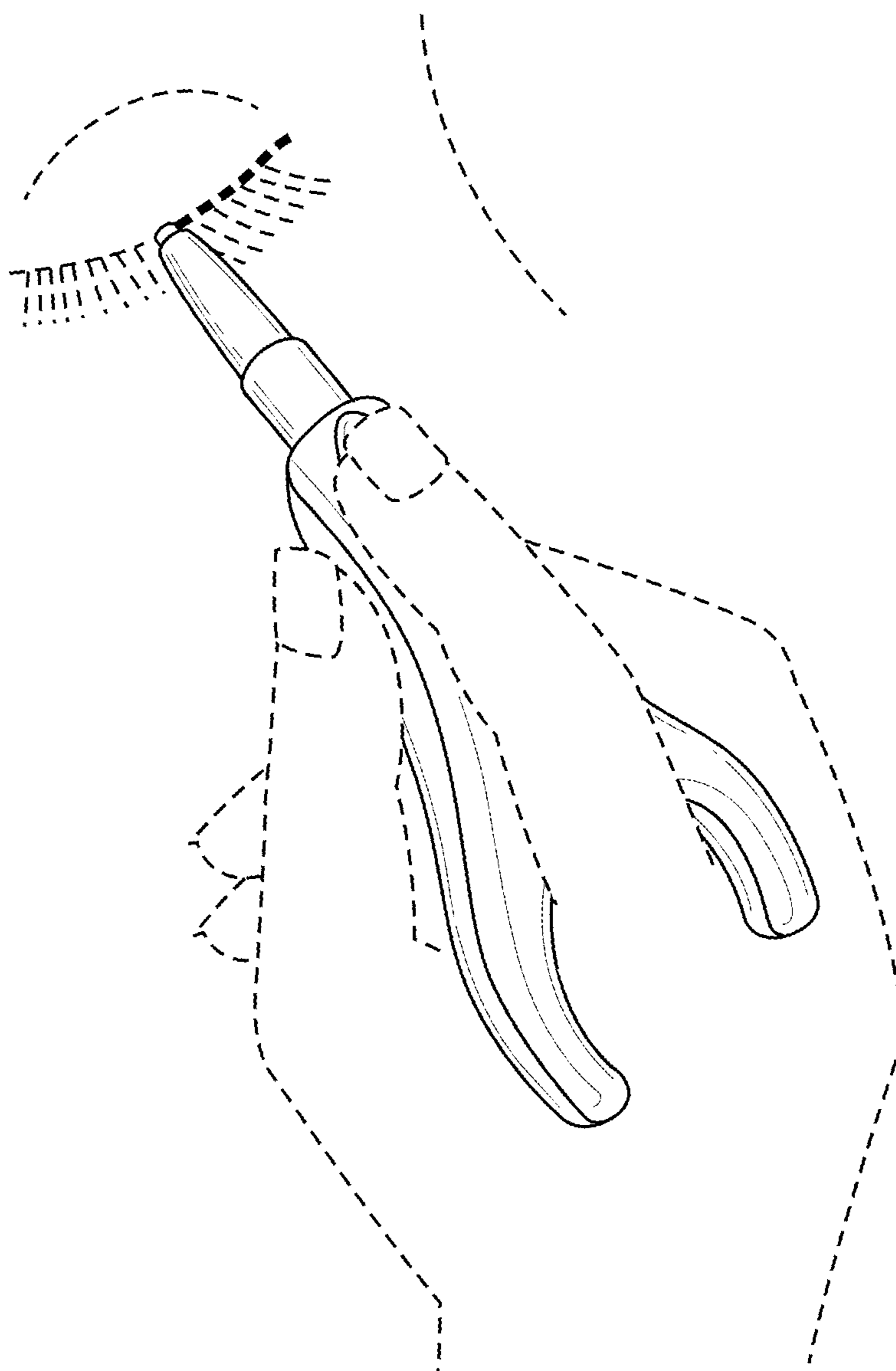

FIG. 8