



US00D817436S

(12) **United States Design Patent** (10) **Patent No.:** **US D817,436 S**
Bender (45) **Date of Patent:** **** May 8, 2018**

- (54) **FIREARM HAMMER**
- (71) Applicant: **In Ovation LLC**, Vadnais Heights, MN (US)
- (72) Inventor: **Terrence Dwight Bender**, Minneapolis, MN (US)
- (73) Assignee: **In Ovation, LLC**, Vadnais Heights, MN (US)
- (**) Term: **15 Years**
- (21) Appl. No.: **29/565,736**
- (22) Filed: **May 24, 2016**

Primary Examiner — Michael A. Pratt
(74) *Attorney, Agent, or Firm* — Vidas, Arrett & Steinkraus

(57) **CLAIM**

The ornamental design for a firearm hammer, as shown and described.

DESCRIPTION

- Related U.S. Application Data**
- (62) Division of application No. 29/504,295, filed on Oct. 3, 2014, now Pat. No. Des. 757,199.
 - (51) **LOC (11) Cl.** **22-01**
 - (52) **U.S. Cl.**
USPC **D22/108**
 - (58) **Field of Classification Search**
USPC D22/104, 108
CPC F41C 3/14; F41C 3/16; F41C 3/04
See application file for complete search history.

FIG. 1 is a front left isometric view of another embodiment of the firearm hammer.
 FIG. 2 is a left side view of the firearm hammer.
 FIG. 3 is a right side view of the firearm hammer.
 FIG. 4 is a front view of the firearm hammer.
 FIG. 5 is a rear view of the firearm hammer.
 FIG. 6 is a top view of the firearm hammer.
 FIG. 7 is a bottom view of the firearm hammer.
 FIG. 8 is a front left isometric view of another embodiment of the firearm hammer.
 FIG. 9 is a left side view of the firearm hammer.
 FIG. 10 is a right side view of the firearm hammer.
 FIG. 11 is a front view of the firearm hammer.
 FIG. 12 is a rear view of the firearm hammer.
 FIG. 13 is a top view of the firearm hammer.
 FIG. 14 is a bottom view of the firearm hammer.
 FIG. 15 is a front left isometric view of another embodiment of the firearm hammer.
 FIG. 16 is a left side view of the firearm hammer.
 FIG. 17 is a right side view of the firearm hammer.
 FIG. 18 is a front view of the firearm hammer.
 FIG. 19 is a rear view of the firearm hammer.
 FIG. 20 is a top view of the firearm hammer; and,
 FIG. 21 is a bottom view of the firearm hammer.
 Broken lines in the Figures show environmental structure or boundaries of the claim, with the broken lines themselves forming no part of the claimed design.

- (56) **References Cited**
- U.S. PATENT DOCUMENTS
- | | | | |
|--------------|---------|---------------|---------|
| 4,208,947 A | 6/1980 | Hillberg | |
| 4,310,981 A | 1/1982 | Waddell | |
| D301,911 S * | 6/1989 | Ruger | D22/104 |
| 5,400,537 A | 3/1995 | Meller et al. | |
| D362,709 S * | 9/1995 | Huening | D22/108 |
| 5,463,829 A | 11/1995 | Sprangers | |
| 5,881,485 A | 3/1999 | Milazzo | |
- (Continued)

OTHER PUBLICATIONS

Priority U.S. Appl. No. 61/461,434, filed Jan. 18, 2011; Inventor: Terrence D. Bender.

(Continued)

1 Claim, 6 Drawing Sheets

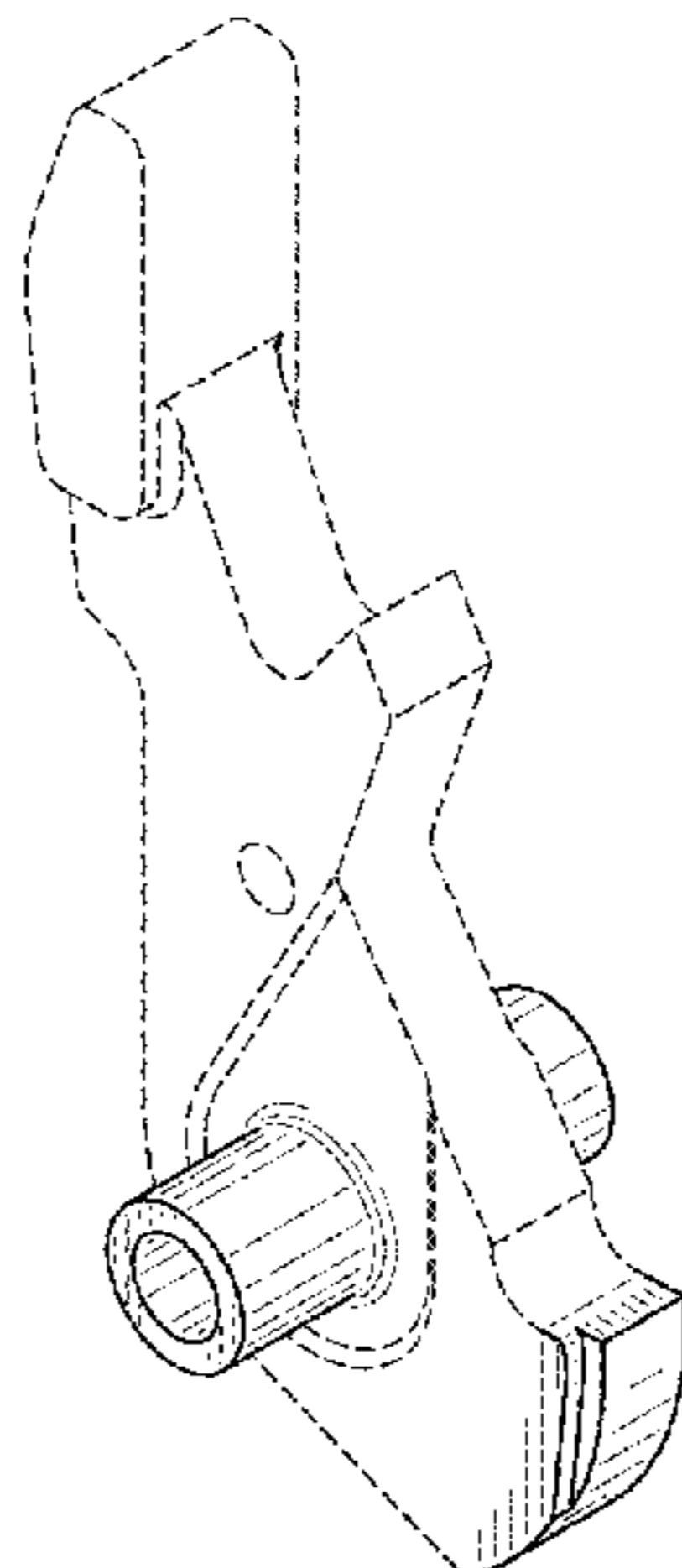

(56)

References Cited

U.S. PATENT DOCUMENTS

5,904,132	A	5/1999	Biller	
6,070,353	A	6/2000	Albrecht et al.	
6,615,527	B1	9/2003	Martin	
6,722,072	B1	4/2004	Mccormick	
7,162,824	B1	1/2007	McCormick	
7,188,561	B1	3/2007	Kelbly	
7,293,385	B2	11/2007	McCormick	
7,331,136	B2	2/2008	Geissele	
7,600,338	B2	10/2009	Geissele	
7,661,220	B2	2/2010	Crandall et al.	
7,854,084	B1	12/2010	Rutherford	
D661,769	S *	6/2012	Geissele	D22/108
8,572,880	B2	11/2013	Bender	
9,052,149	B2 *	6/2015	Bender	F41A 19/10
9,057,573	B1	6/2015	Cockerham et al.	
9,175,917	B2 *	11/2015	Bender	F41A 19/14
D757,199	S *	5/2016	Bender	D22/108
D777,285	S *	1/2017	Bender	D22/108
D777,286	S *	1/2017	Weigand	D22/108
D794,153	S *	8/2017	Capps	D22/108
2002/0088160	A1	7/2002	Beretta	
2008/0010889	A1	1/2008	Metzger et al.	
2009/0183414	A1	7/2009	Geissele	
2010/0281739	A1	11/2010	Geissele	
2011/0185615	A1	8/2011	Gangl	
2014/0338522	A1	11/2014	Bellione	
2015/0047243	A1	2/2015	Tusting	
2015/0233662	A1	8/2015	Ruiz	

OTHER PUBLICATIONS

Priority U.S. Appl. No. 61/462,263, filed Jan. 31, 2011; Inventor: Terrence D. Bender.

Priority U.S. Appl. No. 61/465,241, filed Mar. 16, 2011; Inventor: Terrence D. Bender.

Zediker, Glenn, AR15 Triggers, Zediker Publishing, 2007, pp. 1-3. <http://www.snipershide.com/forum/ubbthreads.php?ubb=showthreaded&Number=501733>, Jan. 26, 2012.

<http://www.compasslake.com/trigger.htm>, Jan. 26, 2012.

http://www.jp Rifles.com/1.4.8.1_ezt.php, Jan. 26, 2012.

<http://cmmginc.secure-mall.com/item/CMMG-Two-Stage-Trigger-1504>, Jan. 26, 2012.

<http://shopwilsoncombat.com/Tactical-Trigger-Unit-Single-Stage-Semi-Auto/productinfo/TR-TTU/?gclid=CP6b79SY8aYCFYQUKgodTRRBBg>, Jan. 26, 2012.

<http://geissele.com/index.aspx>, Jan. 26, 2012.

<http://www.midwayusa.com/product/709049/jewell-trigger-assembly-ar-15-small-pin-154-two-stage-matte>, Jan. 26, 2012.

http://www.jardinc.com/index.php?option=com_content&view=article&id=12:ar-le&catid=18:ar-15-single-stage&Itemid=6, Jan. 26, 2012.

Schematic drawing, Gun Assy, BFG-50A, Serbu Firearms, Inc., Apr. 25, 2011, p. 1.

Priority U.S. Appl. No. 61/963,410, filed Dec. 3, 2013; Inventor: Terrence D. Bender.

U.S. Appl. No. 14/226,576, filed Mar. 26, 2014; Inventor: Terrence D. Bender.

* cited by examiner

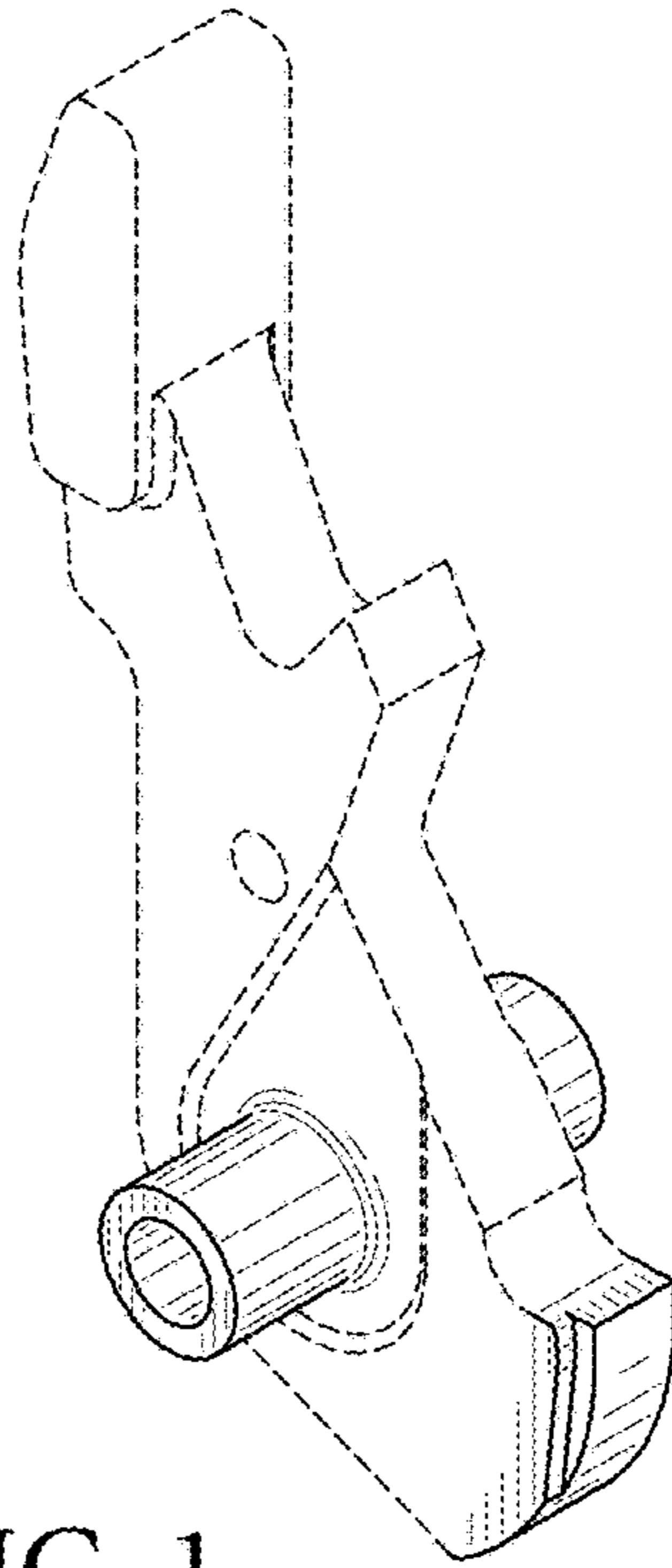

FIG. 1

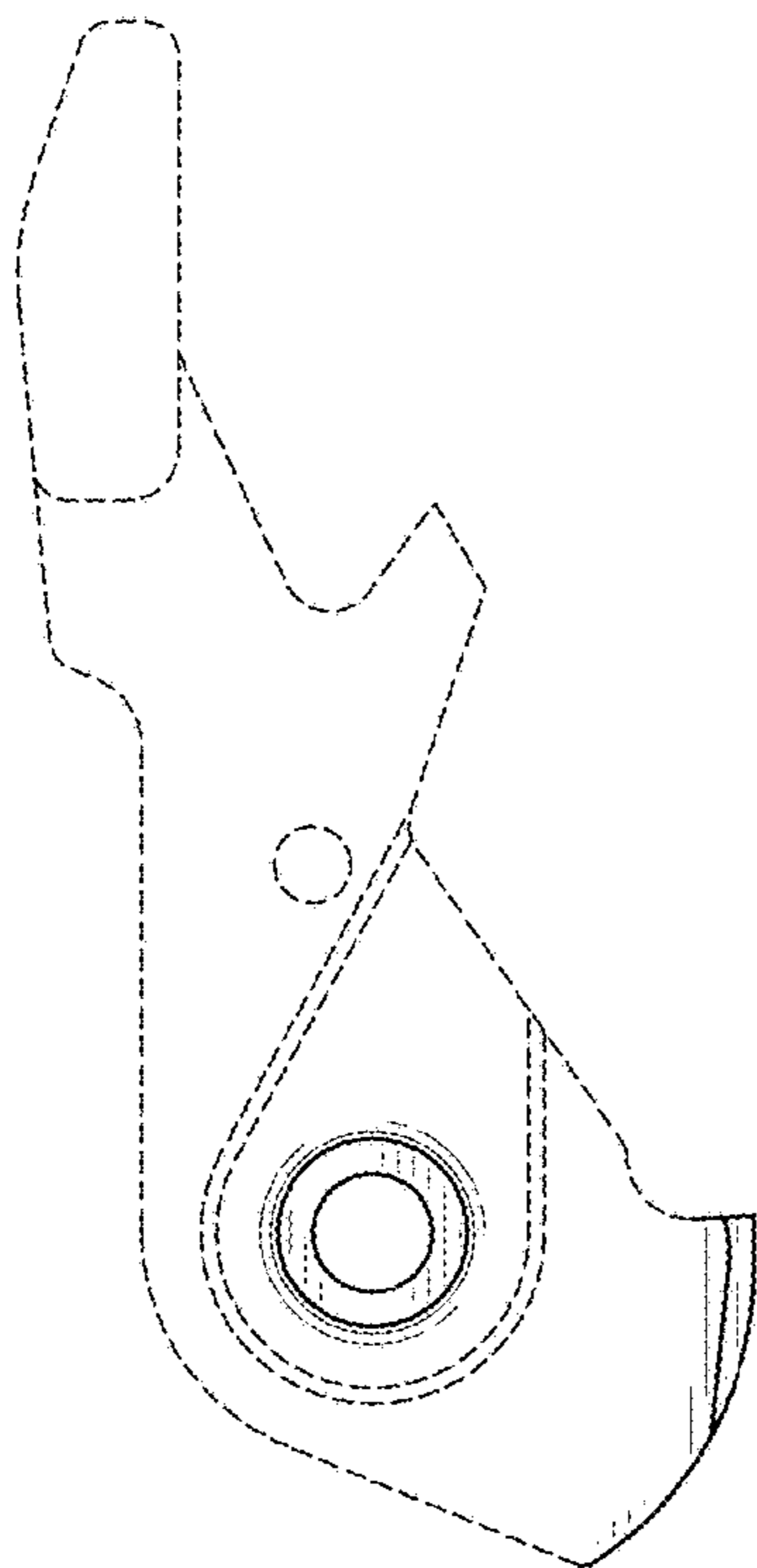

FIG. 2

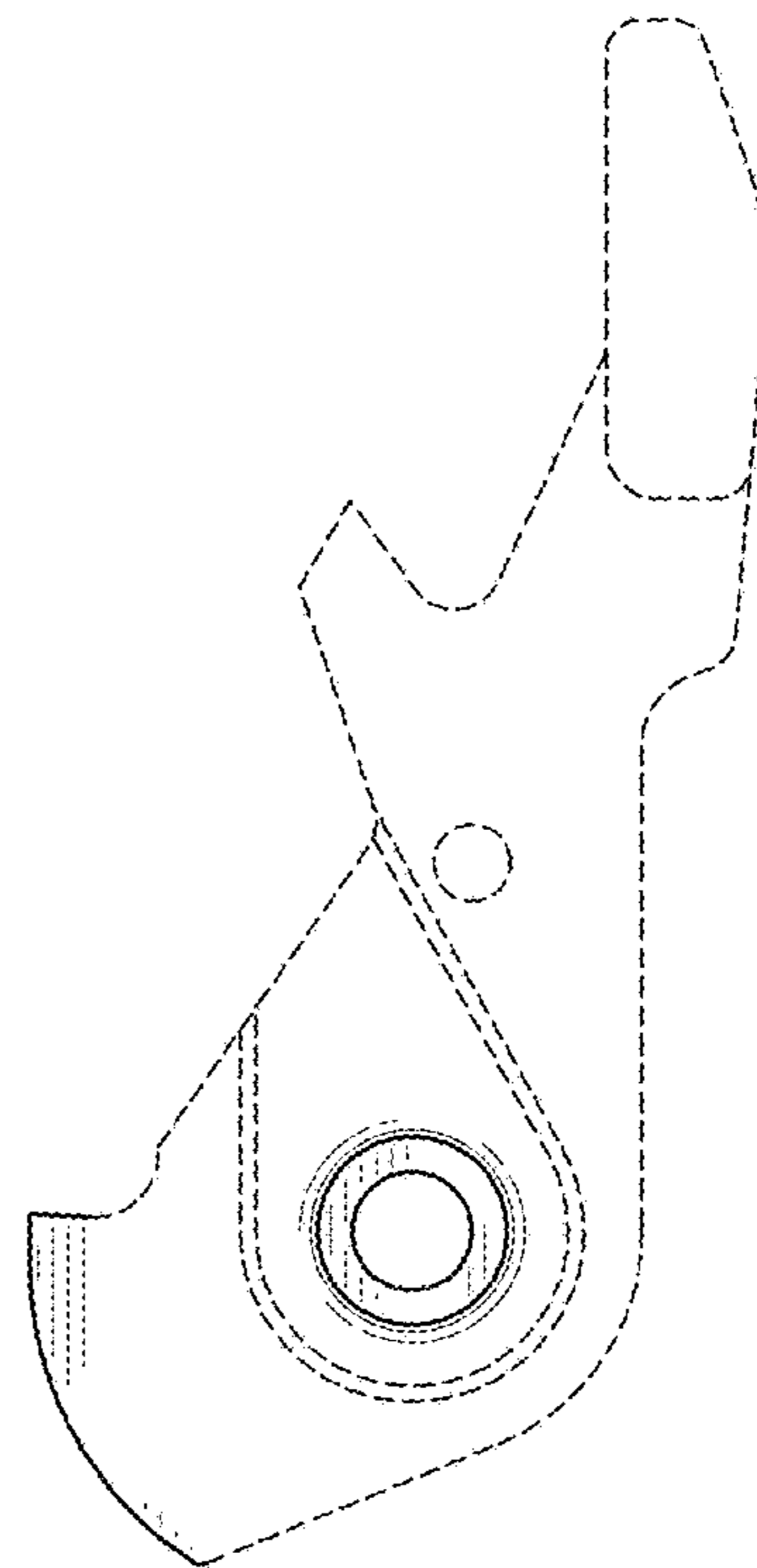

FIG. 3

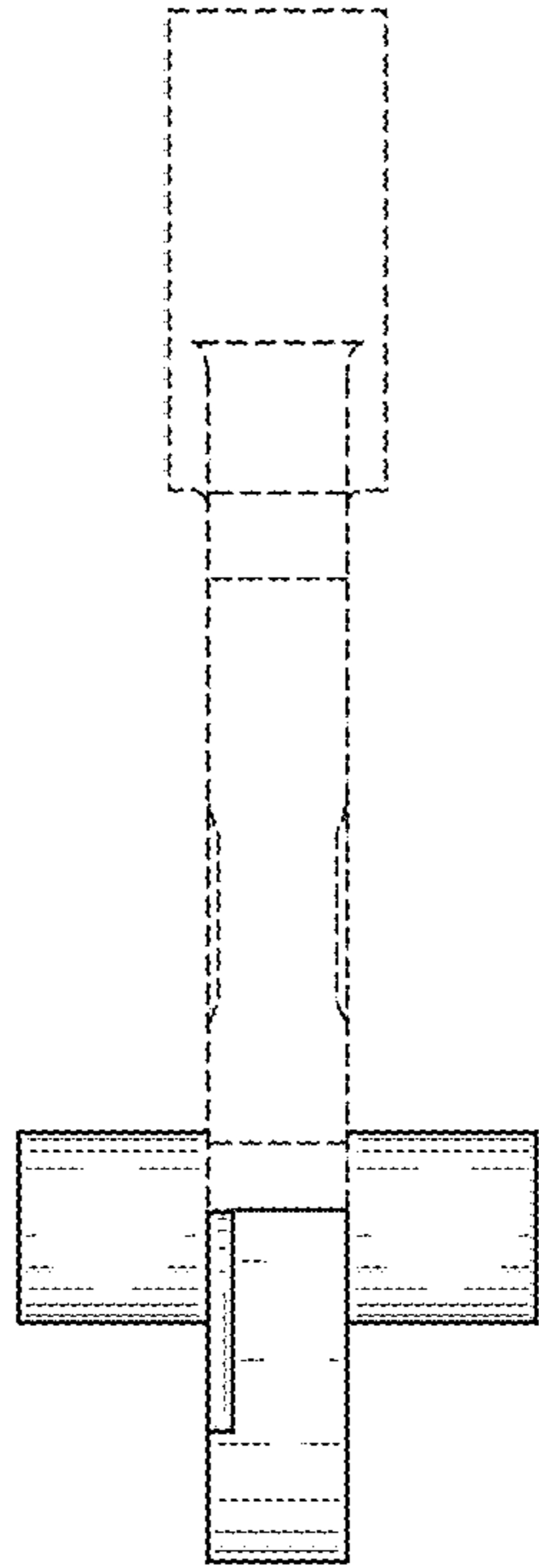

FIG. 4

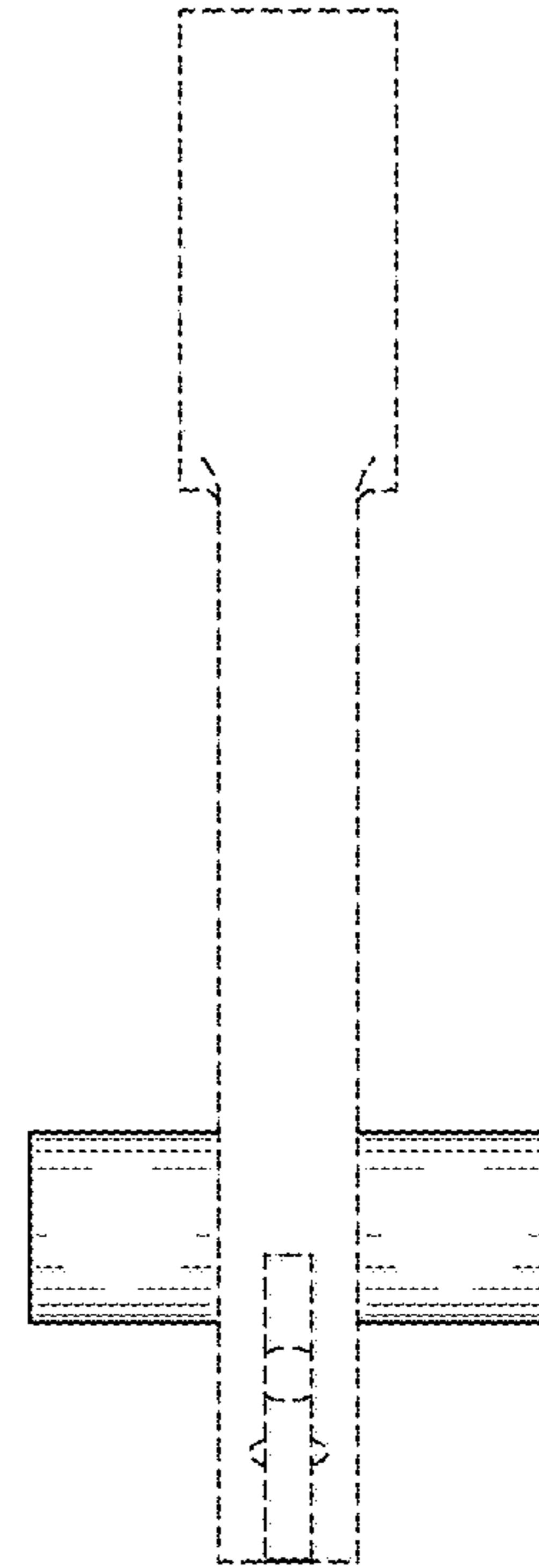

FIG. 5

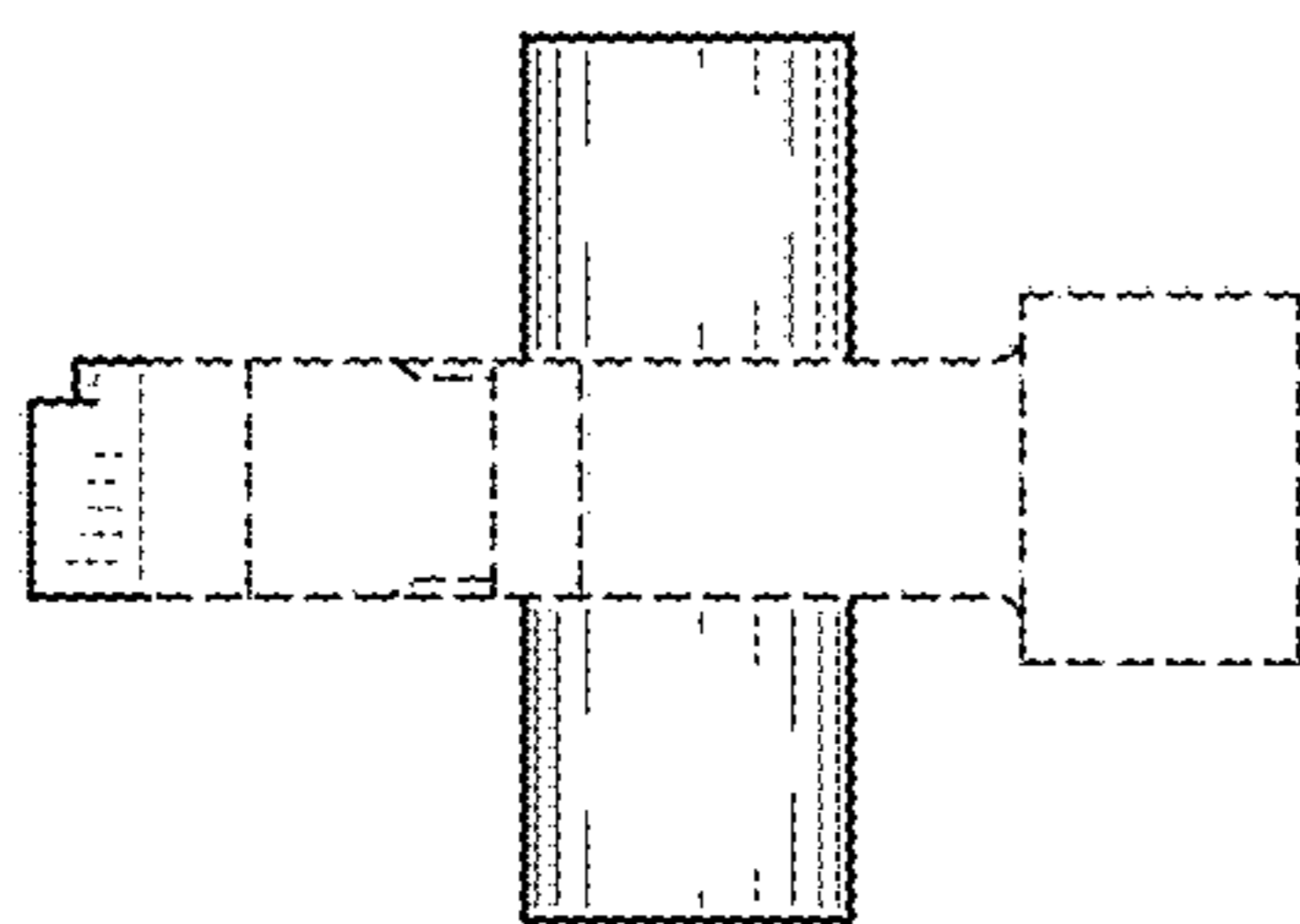

FIG. 6

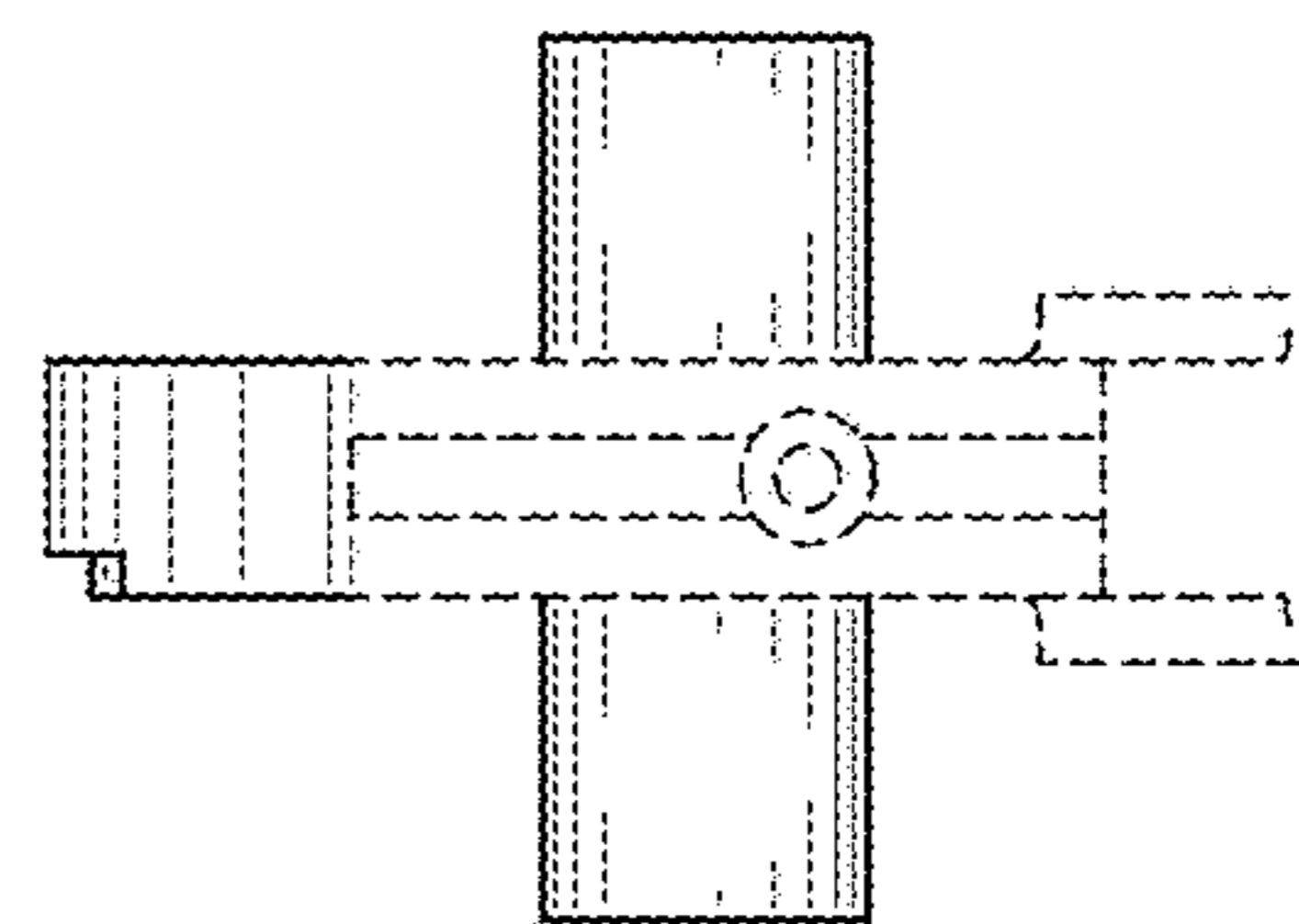

FIG. 7

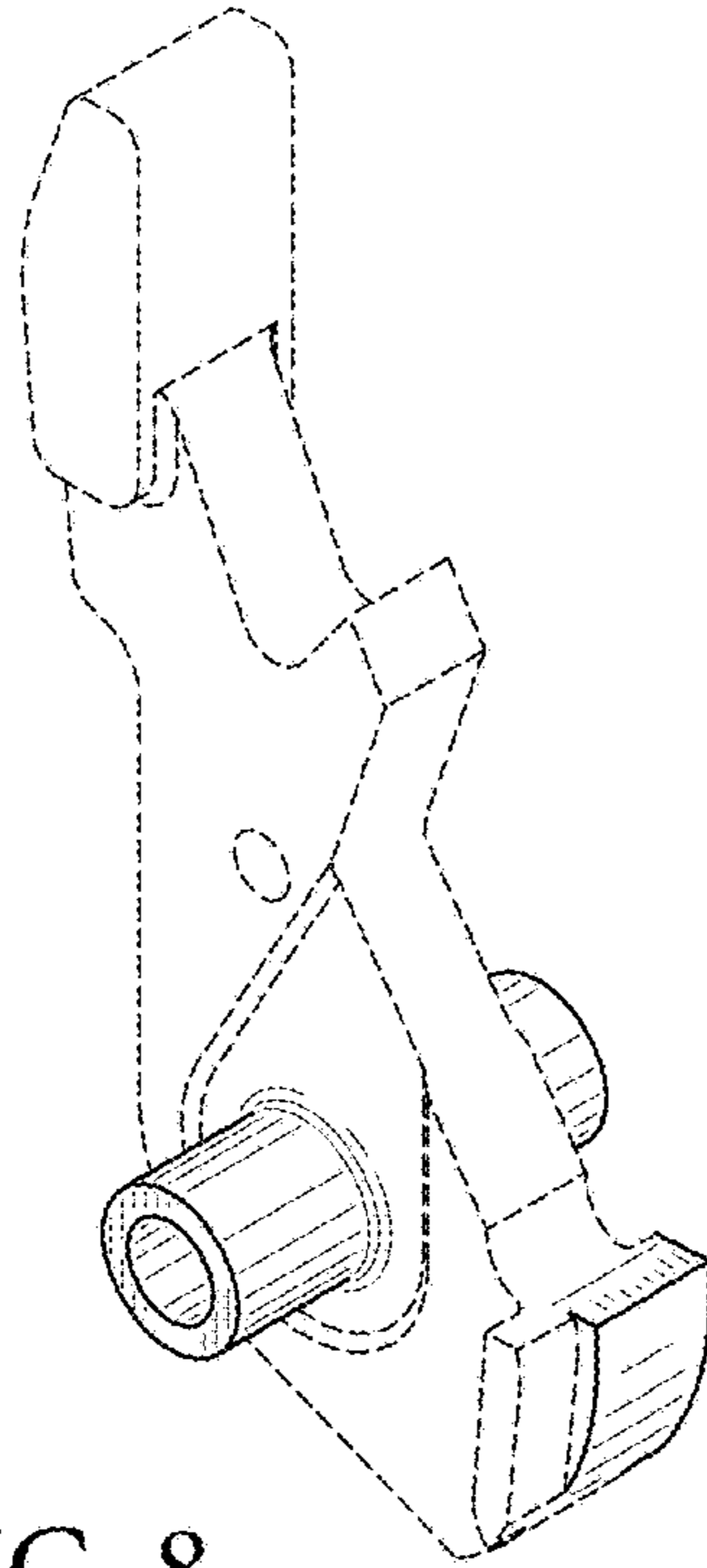

FIG. 8

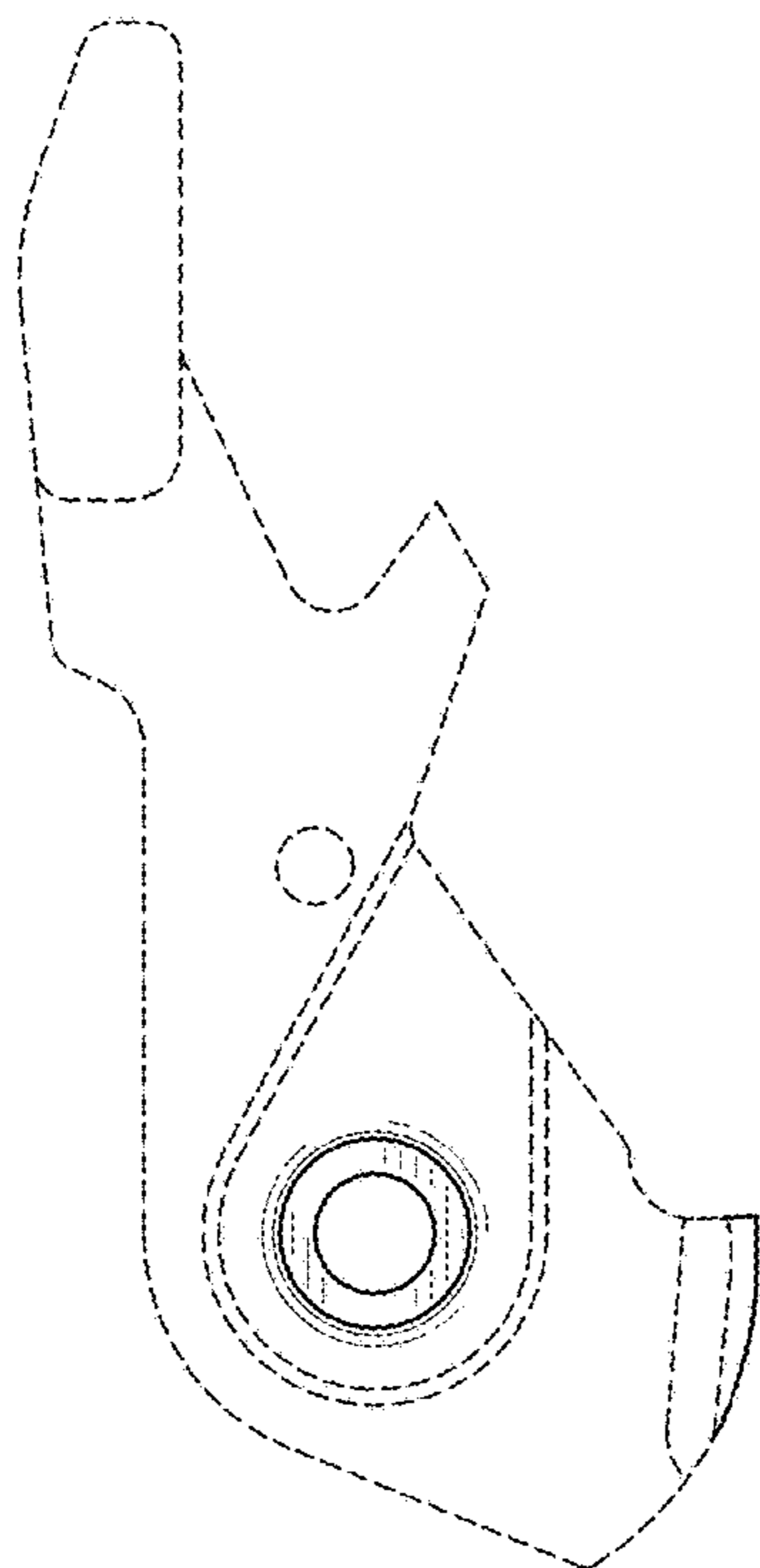

FIG. 9

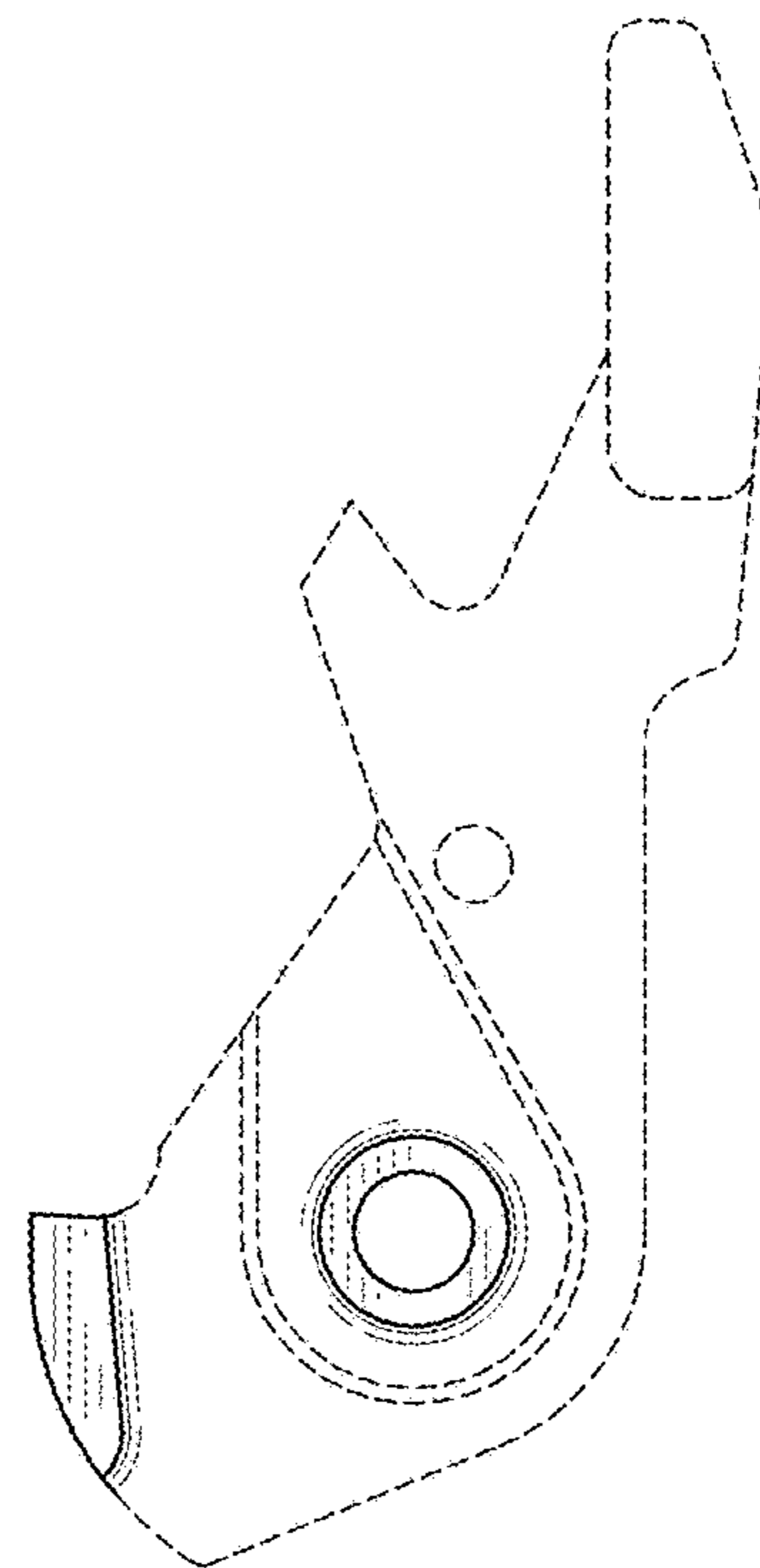

FIG. 10

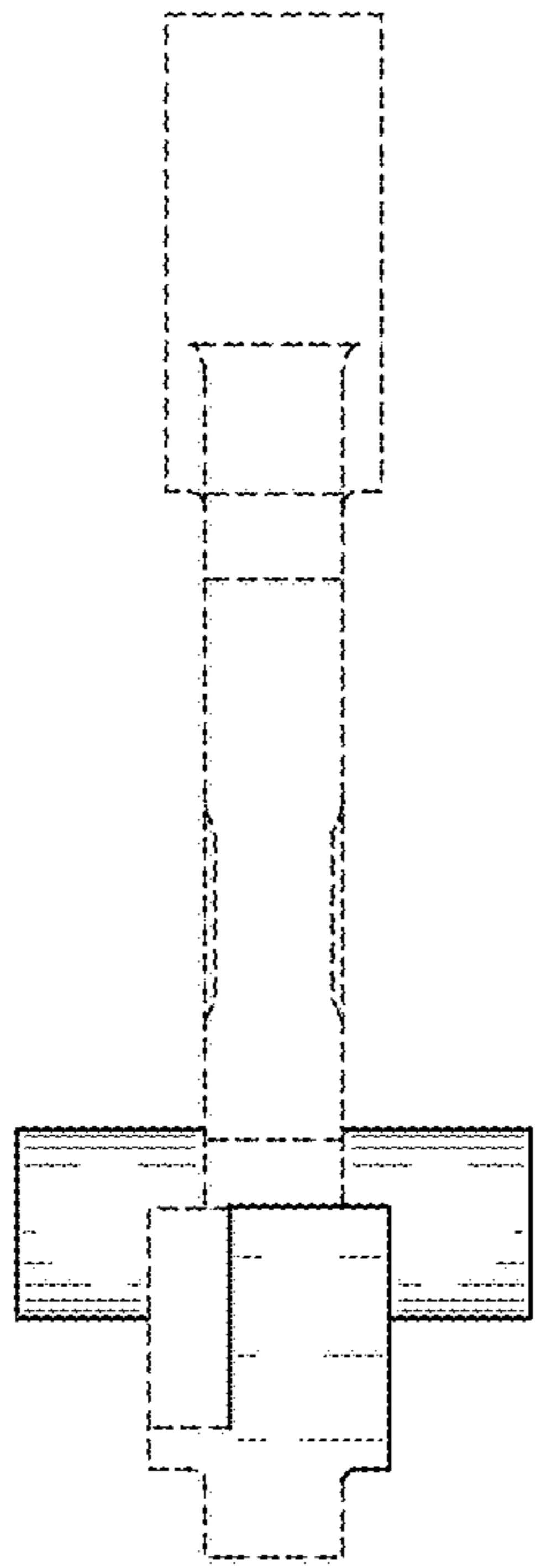

FIG. 11

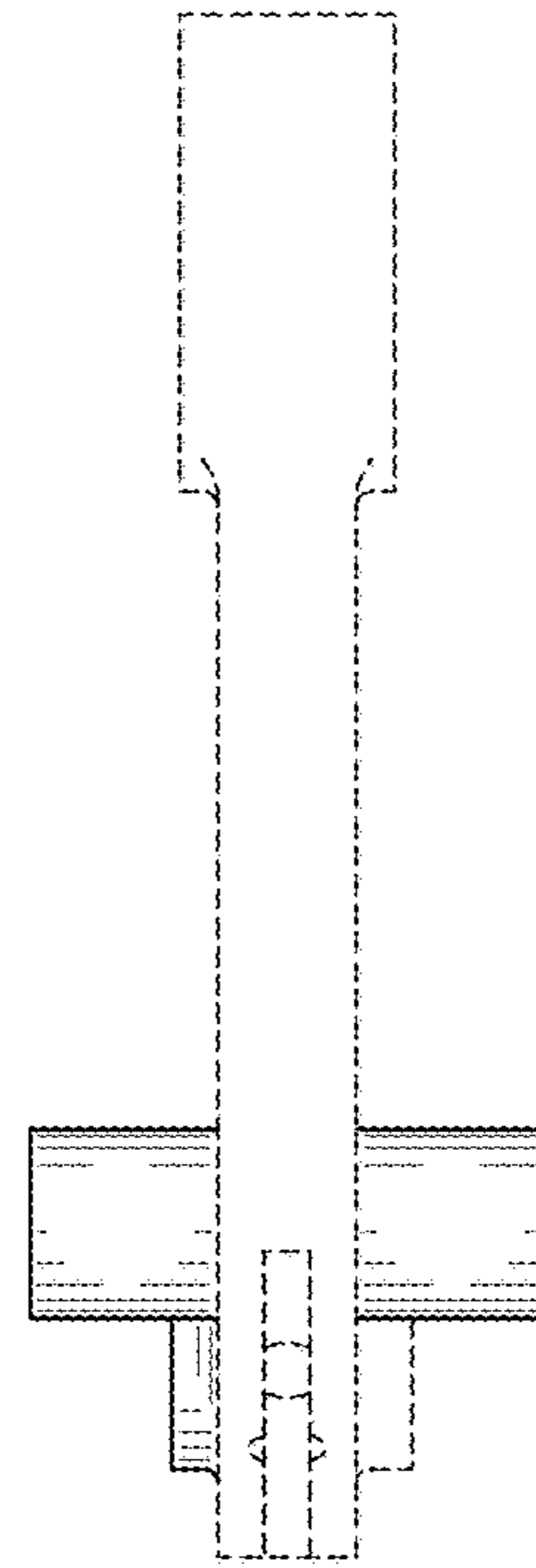

FIG. 12

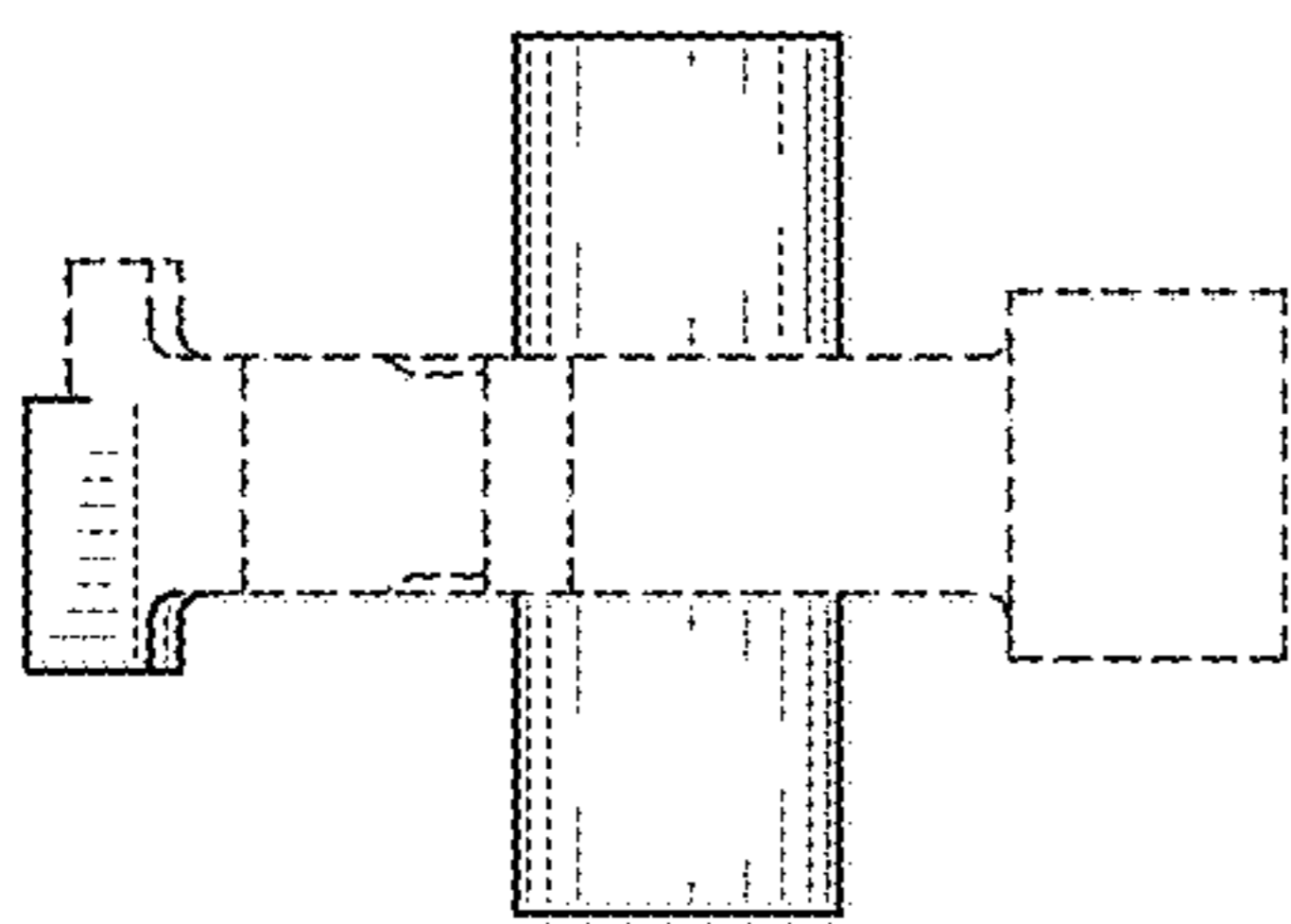

FIG. 13

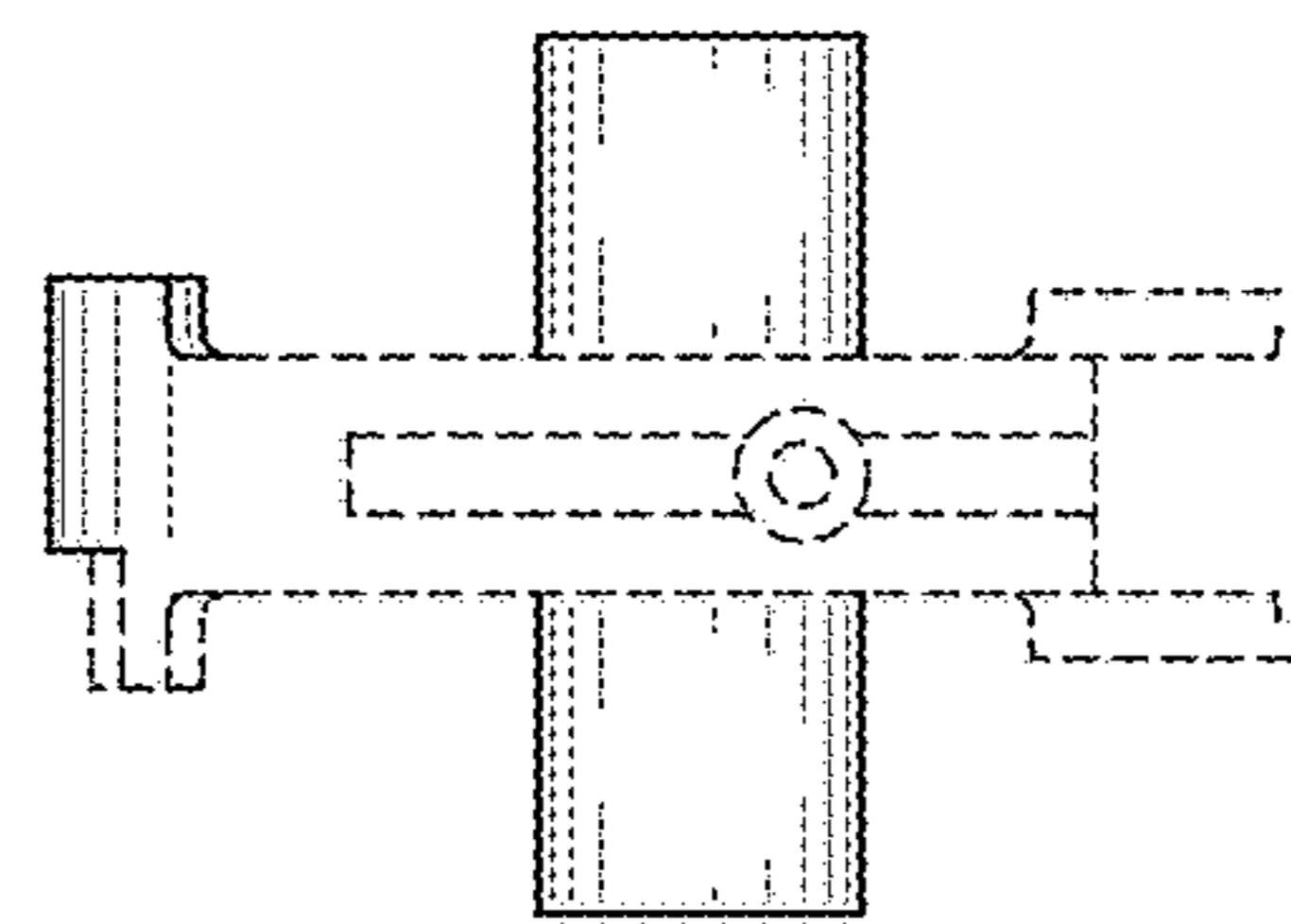

FIG. 14

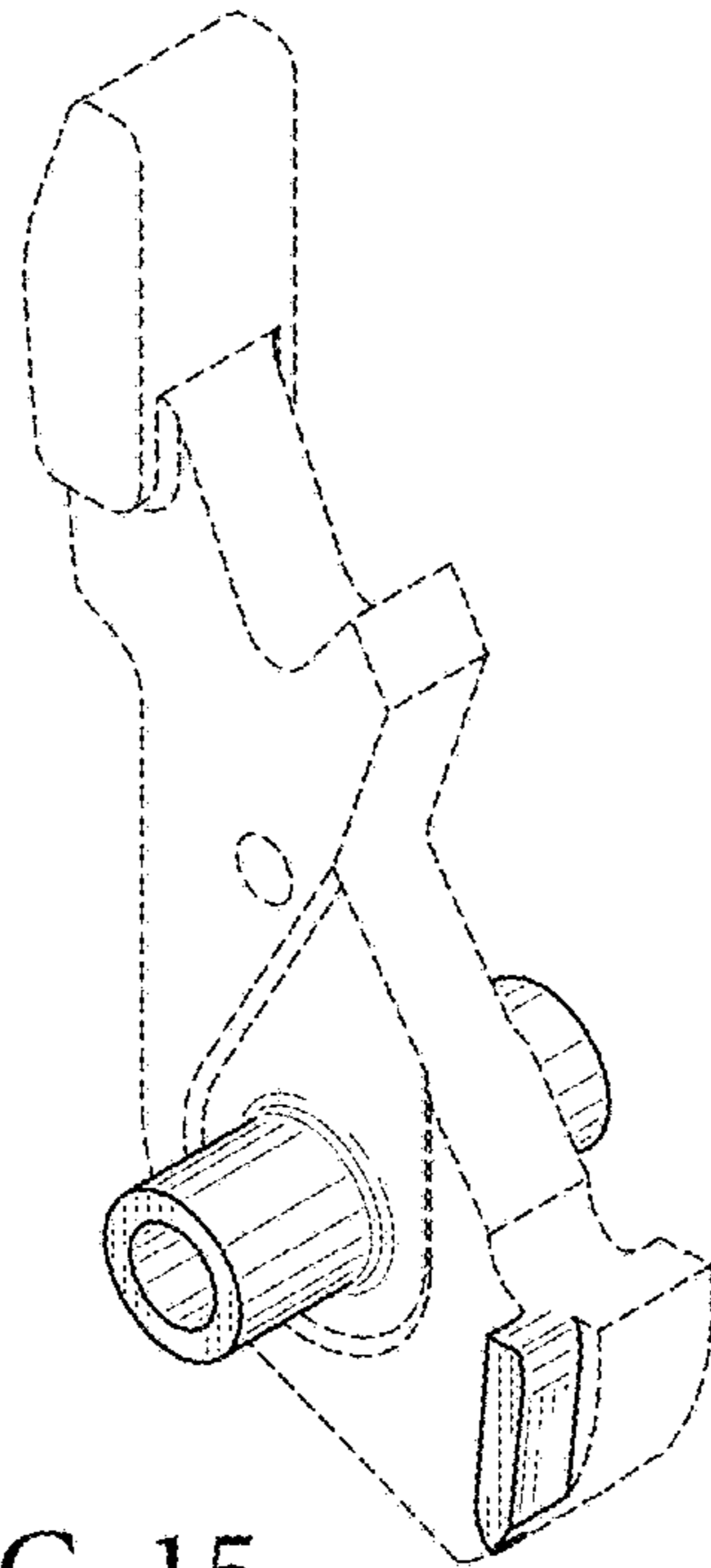

FIG. 15

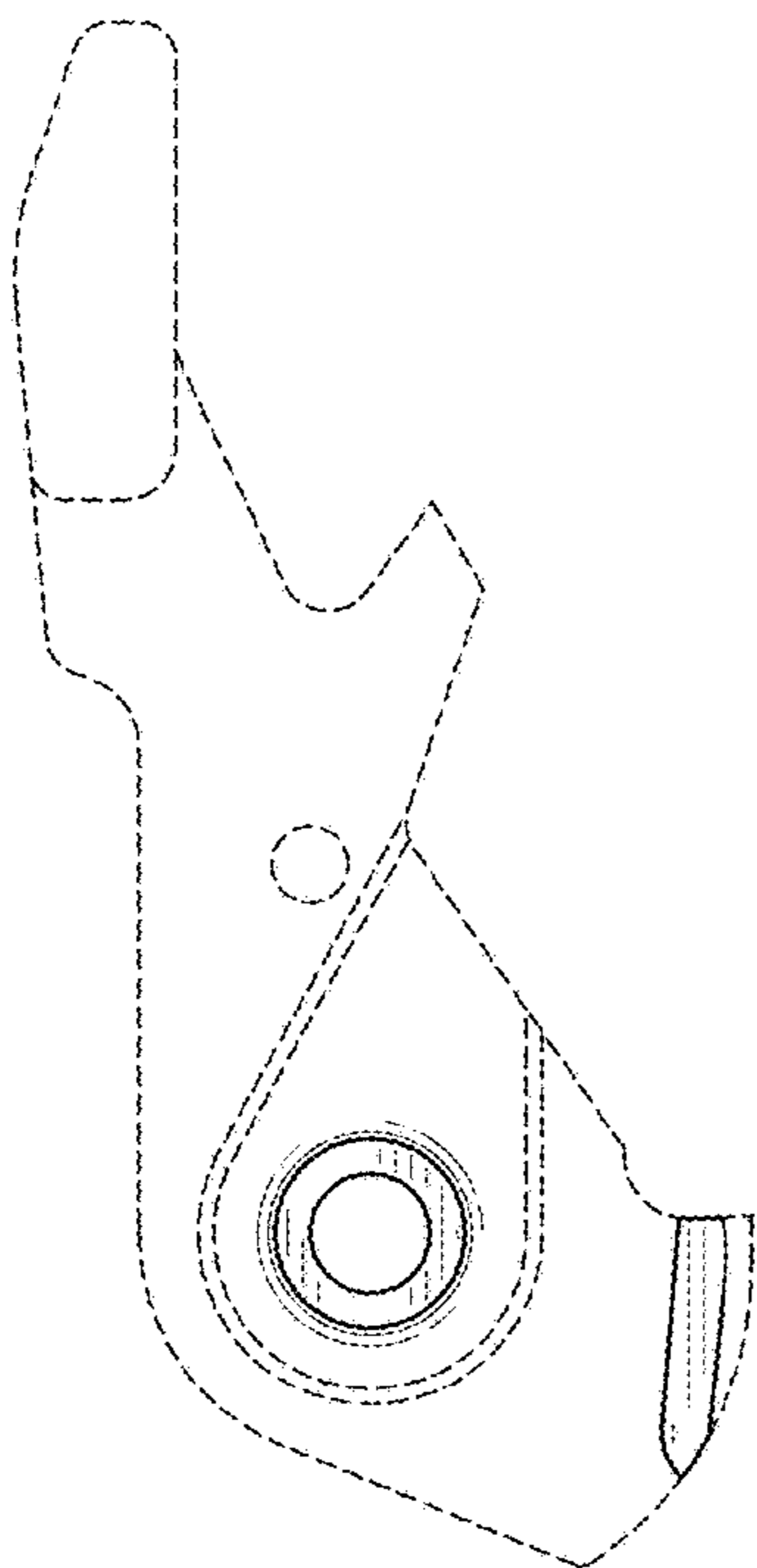

FIG. 16

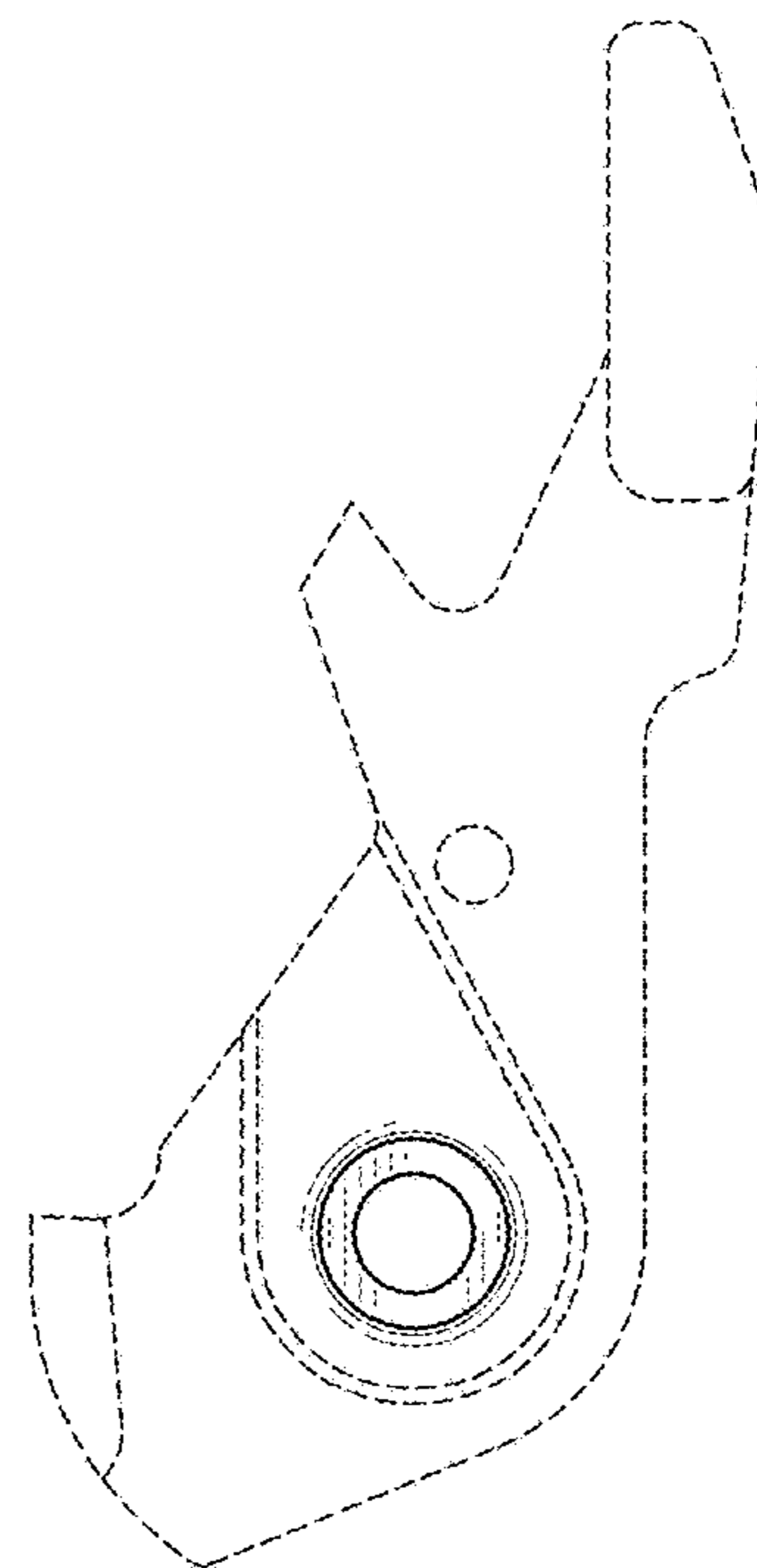

FIG. 17

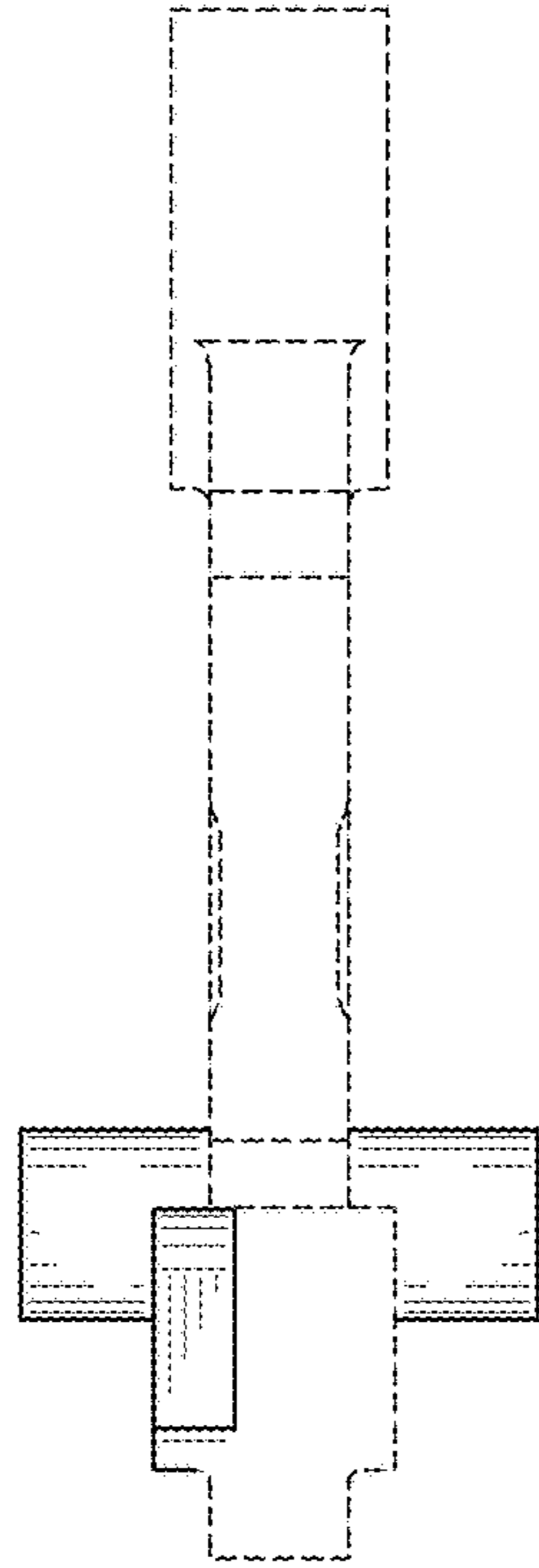

FIG. 18

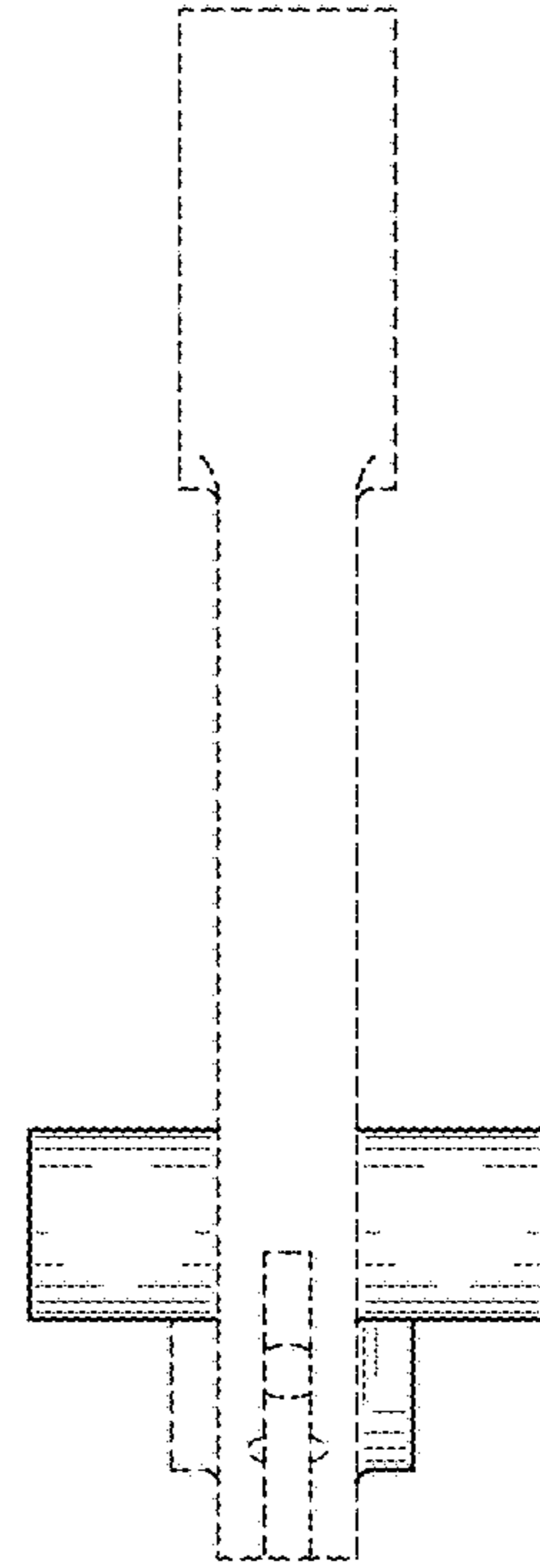

FIG. 19

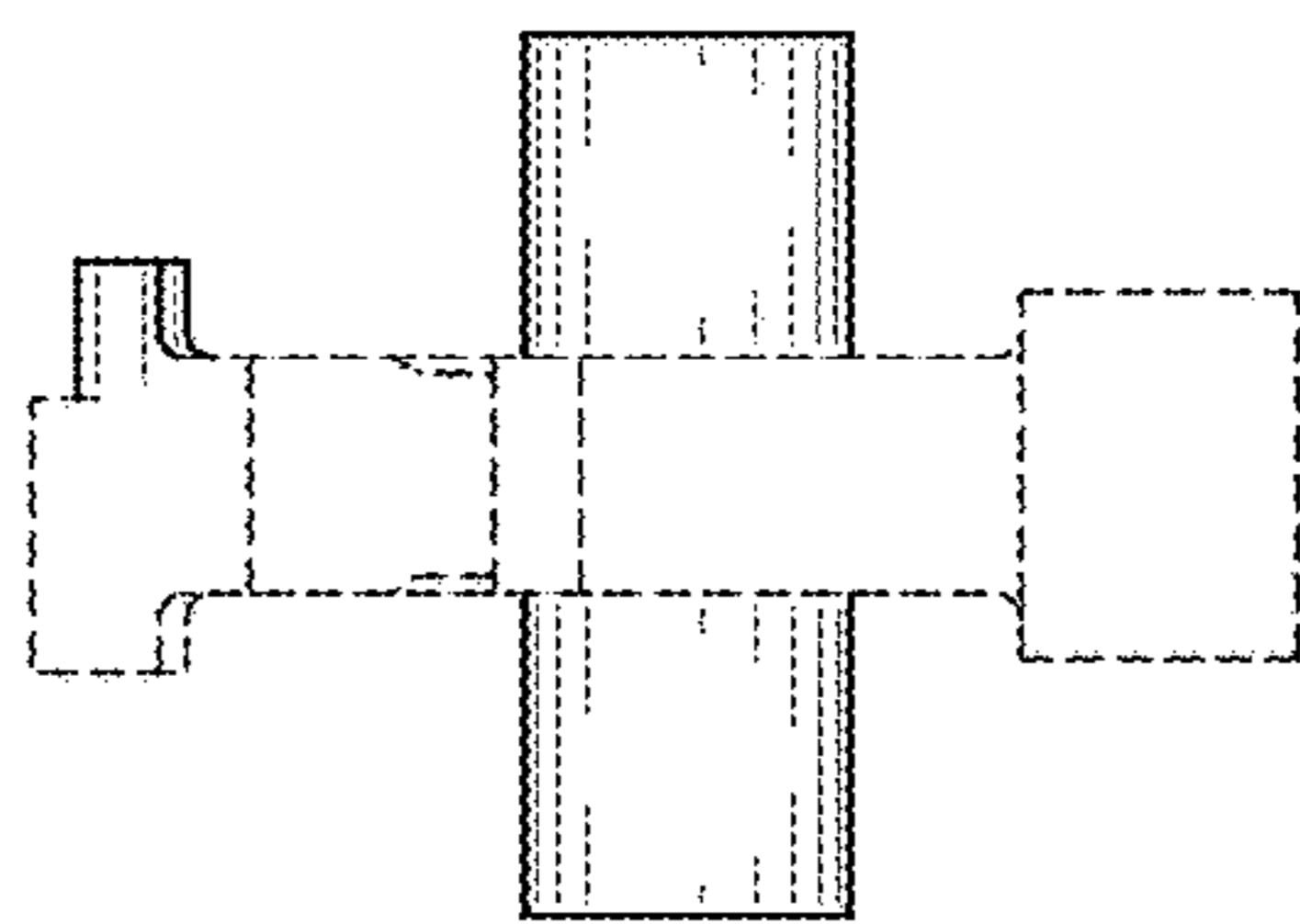

FIG. 20

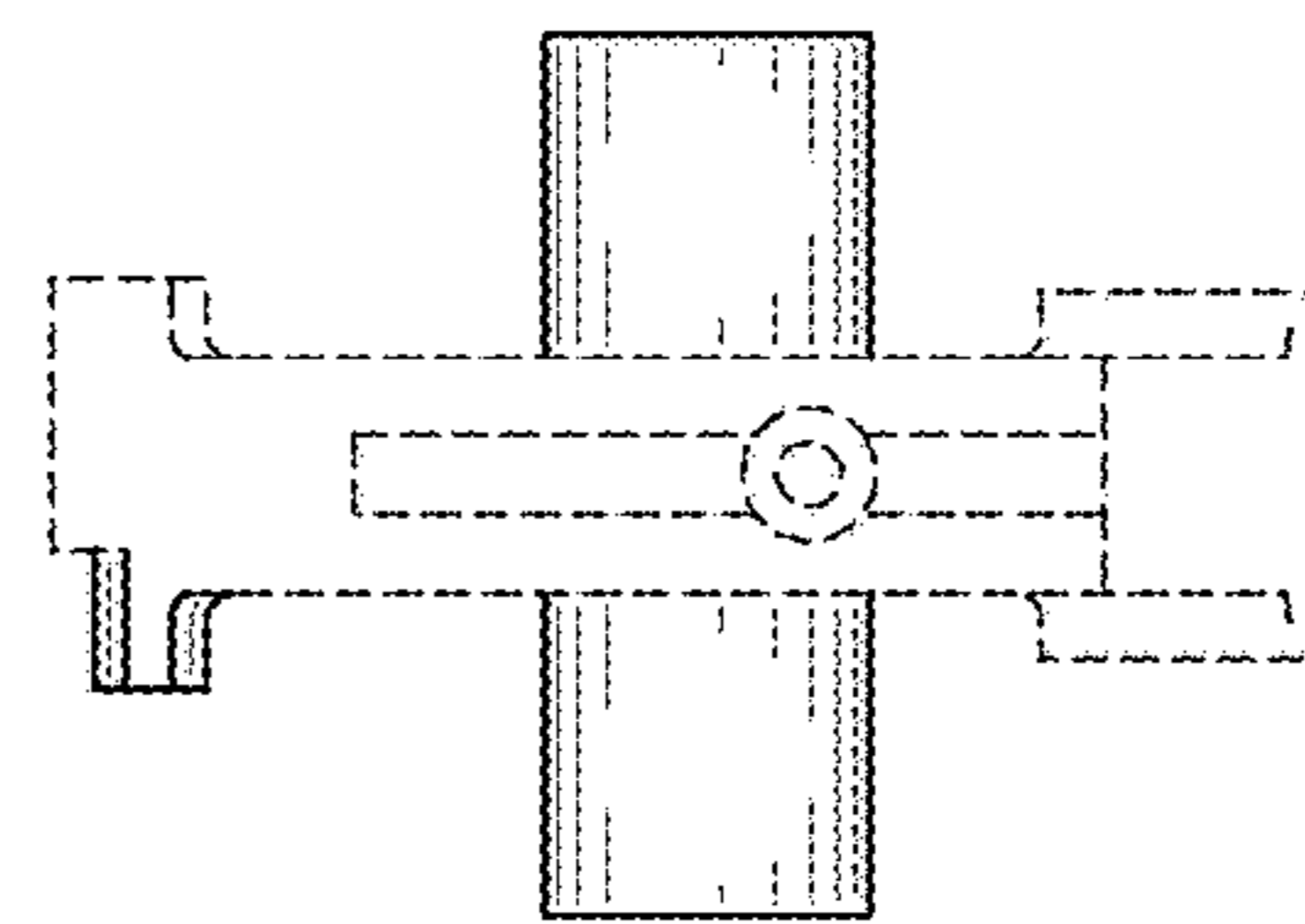

FIG. 21