



US00D817418S

(12) **United States Design Patent** (10) **Patent No.:** **US D817,418 S**  
**Cornell et al.** (45) **Date of Patent:** **\*\* May 8, 2018**

(54) **BASKETBALL BACKBOARD**

D10/113.4; D8/353, 400, 404; D11/86,  
D11/95, 132, 140, 164; D12/401, 167,  
D12/169, 172, 181, 191, 193, 195, 196,  
(Continued)

(71) Applicant: **Indian Industries, Inc.**, Evansville, IN  
(US)

(72) Inventors: **Robert W. Cornell**, Evansville, IN  
(US); **Philip Elpers**, Evansville, IN  
(US)

(56) **References Cited**

U.S. PATENT DOCUMENTS

(73) Assignee: **Indian Industries, Inc.**, Evansville, IN  
(US)

2,583,931 A \* 1/1952 Cummings ..... A47B 43/02  
108/162  
2,704,974 A \* 3/1955 Steman ..... A47G 23/06  
206/518

(\*\*) Term: **15 Years**

(Continued)

(21) Appl. No.: **29/553,727**

FOREIGN PATENT DOCUMENTS

(22) Filed: **Feb. 4, 2016**

EP 0278055 A2 \* 8/1988 ..... A21B 3/15

**Related U.S. Application Data**

*Primary Examiner* — Catherine A Tuttle

(63) Continuation-in-part of application No. 14/973,891,  
filed on Dec. 18, 2015, which is a continuation of  
application No. 14/794,218, filed on Jul. 8, 2015.

(74) *Attorney, Agent, or Firm* — Woodard, Emhardt,  
Moriarty, McNett & Henry, LLP; Charles Meyer

(51) **LOC (11) Cl.** ..... **21-02**

(57) **CLAIM**

(52) **U.S. Cl.**

The ornamental design for a basketball backboard, as shown  
and described.

USPC ..... **D21/701**

**DESCRIPTION**

(58) **Field of Classification Search**

USPC ..... D21/701–704, 301, 334, 338, 365, 392,  
D21/397, 491, 699, 780; D20/10, 13, 15,  
D20/17, 27, 39, 40, 41, 42, 43, 99;  
D25/48.1, 48.8, 138; D7/550.1, 554.3,  
D7/323, 354, 362, 363, 698, 388, 396.1,  
D7/402, 405, 406, 407, 408, 409, 411;  
D32/55–57, 92; D23/260, 354, 386, 388,  
D23/393, 402, 405, 406; D6/300, 406.1,  
D6/691, 691.3, 691.6, 691.7, 692.4,  
D6/692.5, 703, 703.1, 705, 705.4, 705.5,  
D6/707, 707.16, 707.19, 707.24, 707.26,  
D6/711, 553, 555, 574, 610, 612, 616;  
D13/152, 154, 156; D14/441; D15/89;  
D16/235, 241; D19/92, 103, 113;

FIG. 1 is a perspective view of a basketball goal including  
the basketball backboard showing the new design.

FIG. 2 is a perspective view of the basketball backboard in  
FIG. 1.

FIG. 3 is a front view thereof.

FIG. 4 is a rear view thereof.

FIG. 5 is a top view thereof, the bottom view being the same;  
and,

FIG. 6 is a side view thereof, the opposing side view being  
the same.

The broken lines showing the basketball goal and backboard  
surface apertures are for illustrative purposes only; and form  
no part of the claimed design.

**1 Claim, 4 Drawing Sheets**

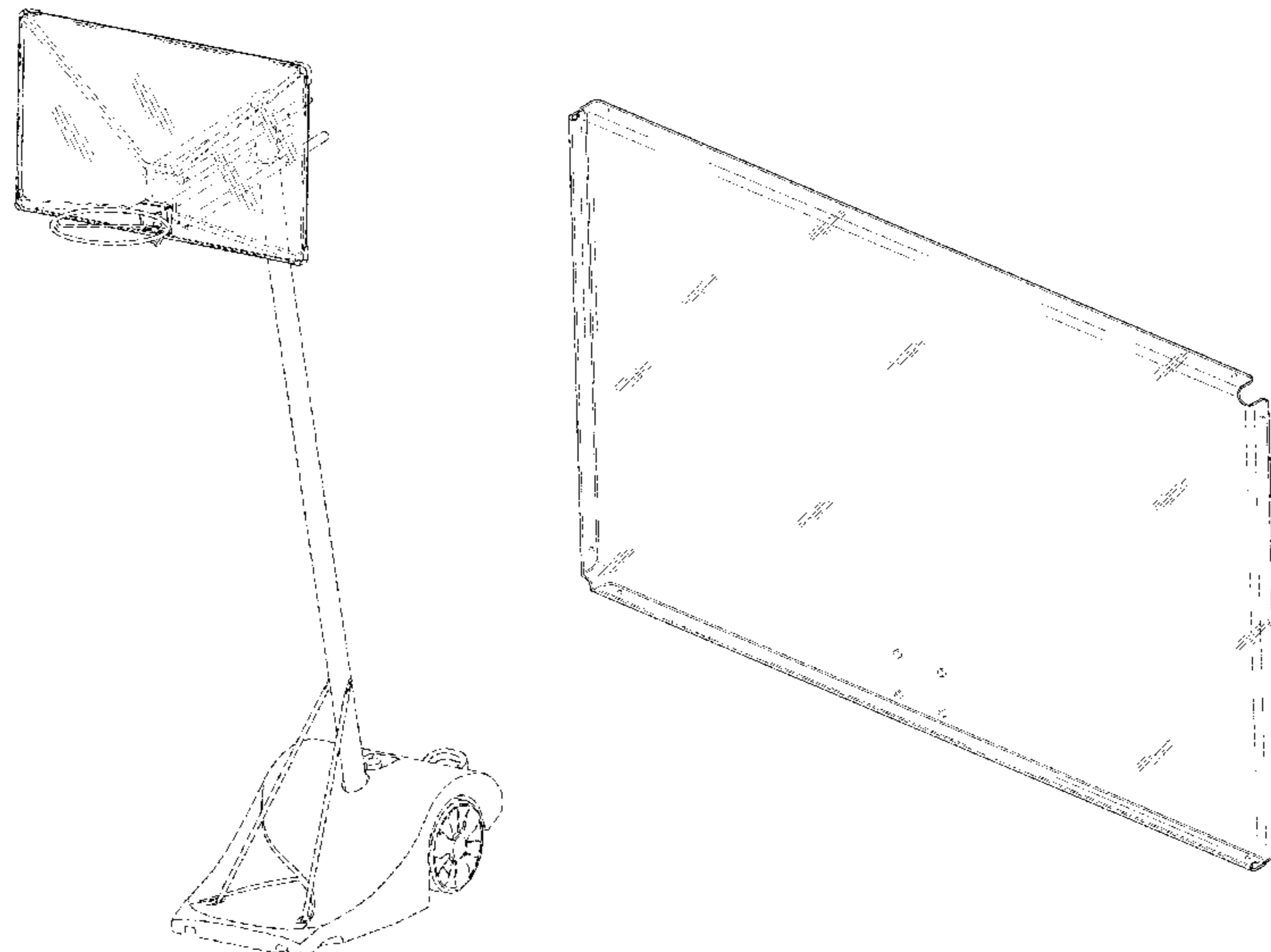

(58) **Field of Classification Search**

USPC ..... D12/203, 216, 221; D26/118-120, 152;  
 D3/247; 473/431, 433, 434, 435, 476,  
 473/479-489; 273/403, 404, 409, 410;  
 40/1, 486, 488-491, 592, 604, 607.1,  
 40/611.12, 611.13, 606.01, 607.06,  
 40/611.06, 612, 613, 616, 649, 651, 725,  
 40/748, 752, 759, 793, 799; 108/136,  
 108/157.1, 157.13, 157.14, 159.12,  
 108/159.11, 158.12, 160, 90, 118, 119,  
 108/151, 153.1, 162, 156, 157.15, 157.16,  
 108/157.17, 158.11, 159, 193;  
 211/119.003, 119.005, 126.16, 135  
 CPC ..... A63B 63/00; A63B 63/08; A63B 63/083;  
 A63B 2063/001; A63B 2063/006; A63B  
 2063/007; A63B 69/0097; A63B  
 2069/0006; A63B 2243/0037; A21B 3/13;  
 A21B 3/131; A21B 3/138; A21B 3/15;  
 F24C 15/14; A47J 37/067; A47J 37/10;  
 G09F 2007/1826; G09F 2007/1843; G09F  
 7/00; G09F 7/04; G09F 7/08; G09F 7/10;  
 G09F 7/12; G09F 7/18; G09F 15/00;  
 G09F 15/0012; G09F 15/0018; G09F  
 15/0025; G09F 15/0031; G09F 15/0056;  
 G09F 15/0062; G09F 1/12; A47B 47/021;  
 A47B 47/024; A47B 47/03; A47B 13/08;  
 A47B 13/083; A47B 13/086; A47B  
 96/02; A47B 96/021; A47B 96/024; A47B  
 96/028; A47B 96/06; A47B 3/06; A47B  
 3/12; A47B 2013/006; A47B 2013/026;  
 A47B 2013/085

See application file for complete search history.

(56) **References Cited**

U.S. PATENT DOCUMENTS

3,374,566 A \* 3/1968 Snediker ..... G09F 7/18  
 40/609

5,018,291 A \* 5/1991 Pasquale ..... G09F 1/12  
 40/584  
 5,215,792 A \* 6/1993 Miller ..... B42D 15/02  
 229/92.8  
 5,839,982 A \* 11/1998 Hying ..... A63B 63/083  
 473/481  
 D404,447 S \* 1/1999 Wiedner ..... 206/315.1  
 5,954,601 A 9/1999 Abrams et al.  
 6,004,231 A 12/1999 Schickert et al.  
 6,077,175 A \* 6/2000 Fearnow ..... A63B 69/0013  
 473/468  
 6,334,822 B1 \* 1/2002 Zider ..... A63B 63/083  
 473/479  
 6,758,788 B2 7/2004 Spencer  
 7,001,290 B2 2/2006 Mower et al.  
 7,331,882 B1 2/2008 White  
 7,393,293 B2 7/2008 Guertzini et al.  
 7,407,453 B2 8/2008 Shannon  
 7,419,445 B2 9/2008 Nye et al.  
 7,691,014 B2 4/2010 Nye et al.  
 D641,188 S \* 7/2011 Lin ..... D6/705  
 D641,210 S \* 7/2011 Hamilton ..... D7/554.3  
 8,109,667 B2 \* 2/2012 Wang ..... G02F 1/133308  
 349/58  
 8,167,745 B2 5/2012 Britto et al.  
 8,398,509 B2 3/2013 Elpers  
 8,523,715 B2 9/2013 Elpers  
 8,852,034 B2 10/2014 Stevens  
 D729,889 S \* 5/2015 Morton ..... D21/701  
 9,545,552 B1 \* 1/2017 Buchweitz, III ..... A63B 63/083  
 9,805,631 B2 \* 10/2017 Howell ..... G09F 15/0068  
 2005/0119074 A1 6/2005 Waite et al.  
 2005/0172531 A1 \* 8/2005 Doctoroff ..... G09F 1/12  
 40/661  
 2012/0000872 A1 \* 1/2012 Troyner ..... A47B 47/021  
 211/150  
 2014/0038731 A1 \* 2/2014 Manner ..... A63F 3/00533  
 463/48  
 2017/0007896 A1 \* 1/2017 Elpers ..... A63B 63/083

\* cited by examiner

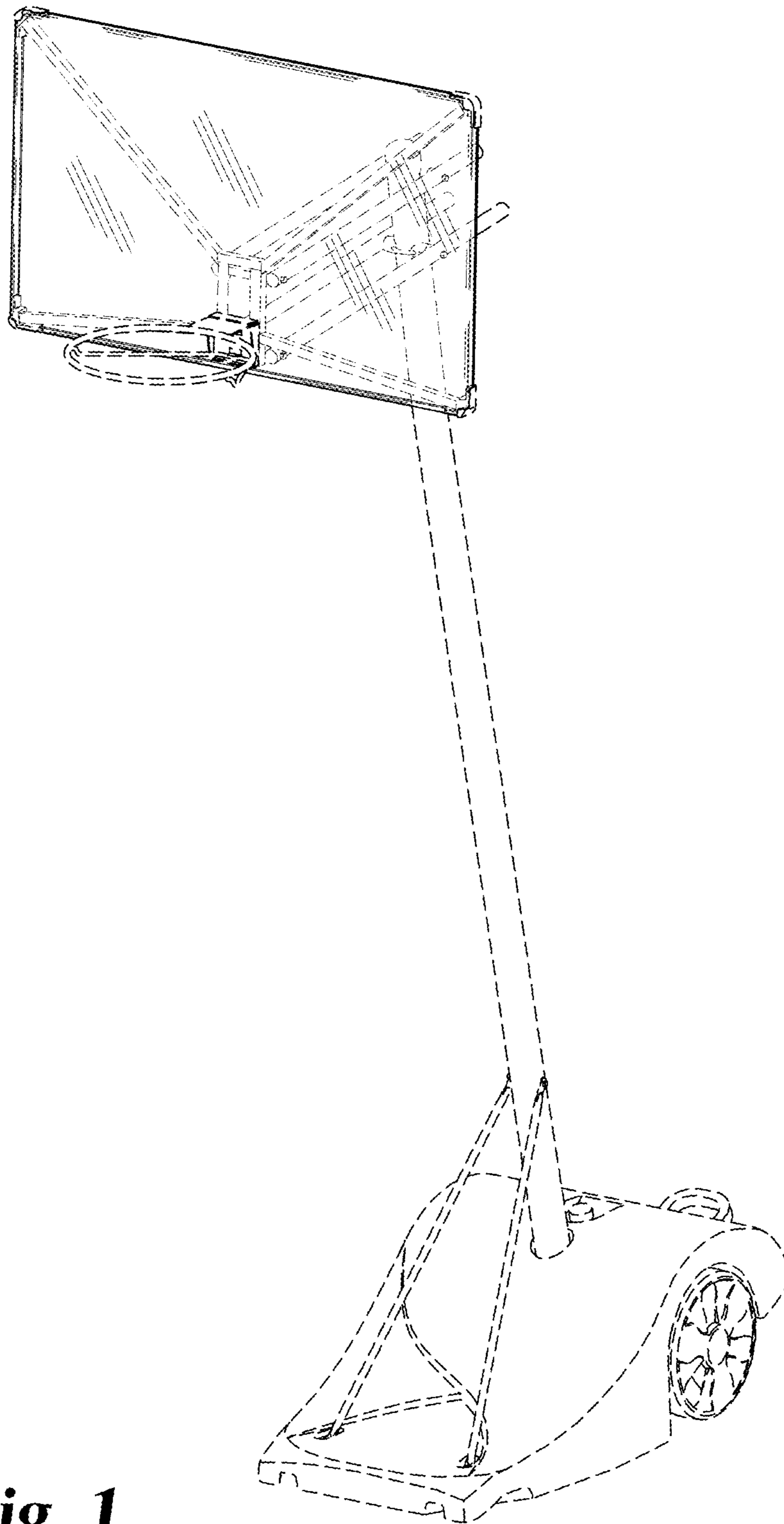

**Fig. 1**

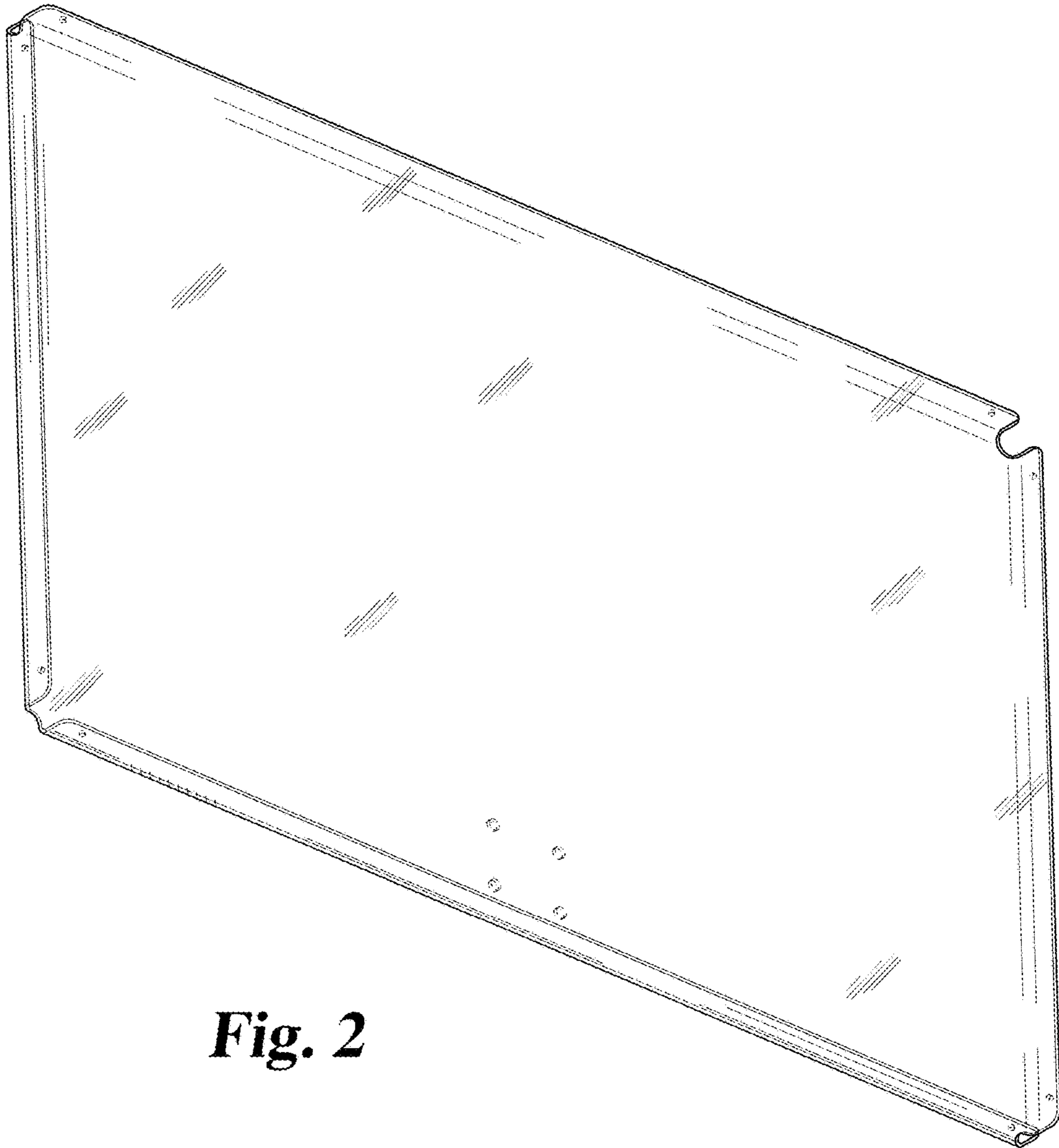

**Fig. 2**

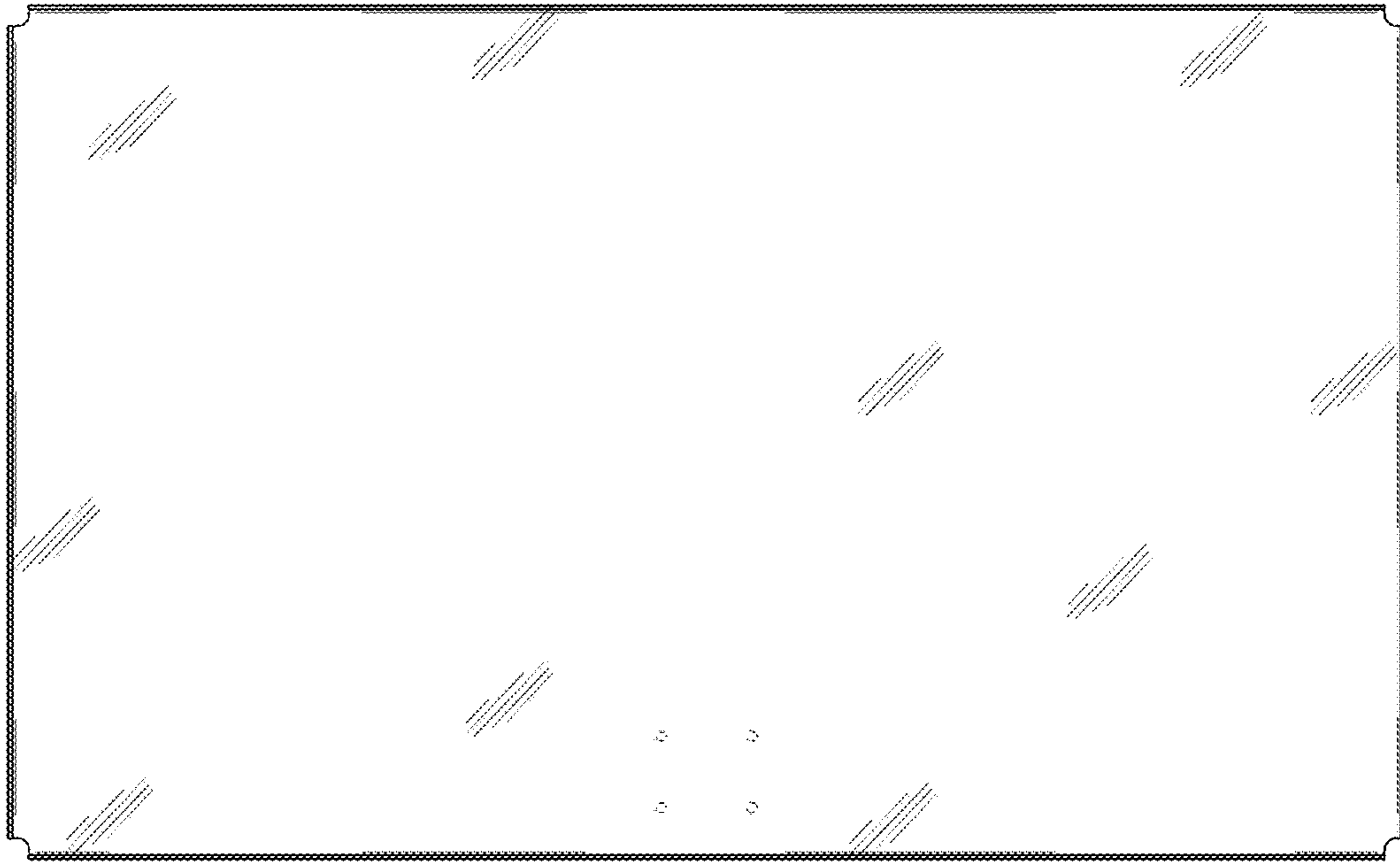

**Fig. 3**

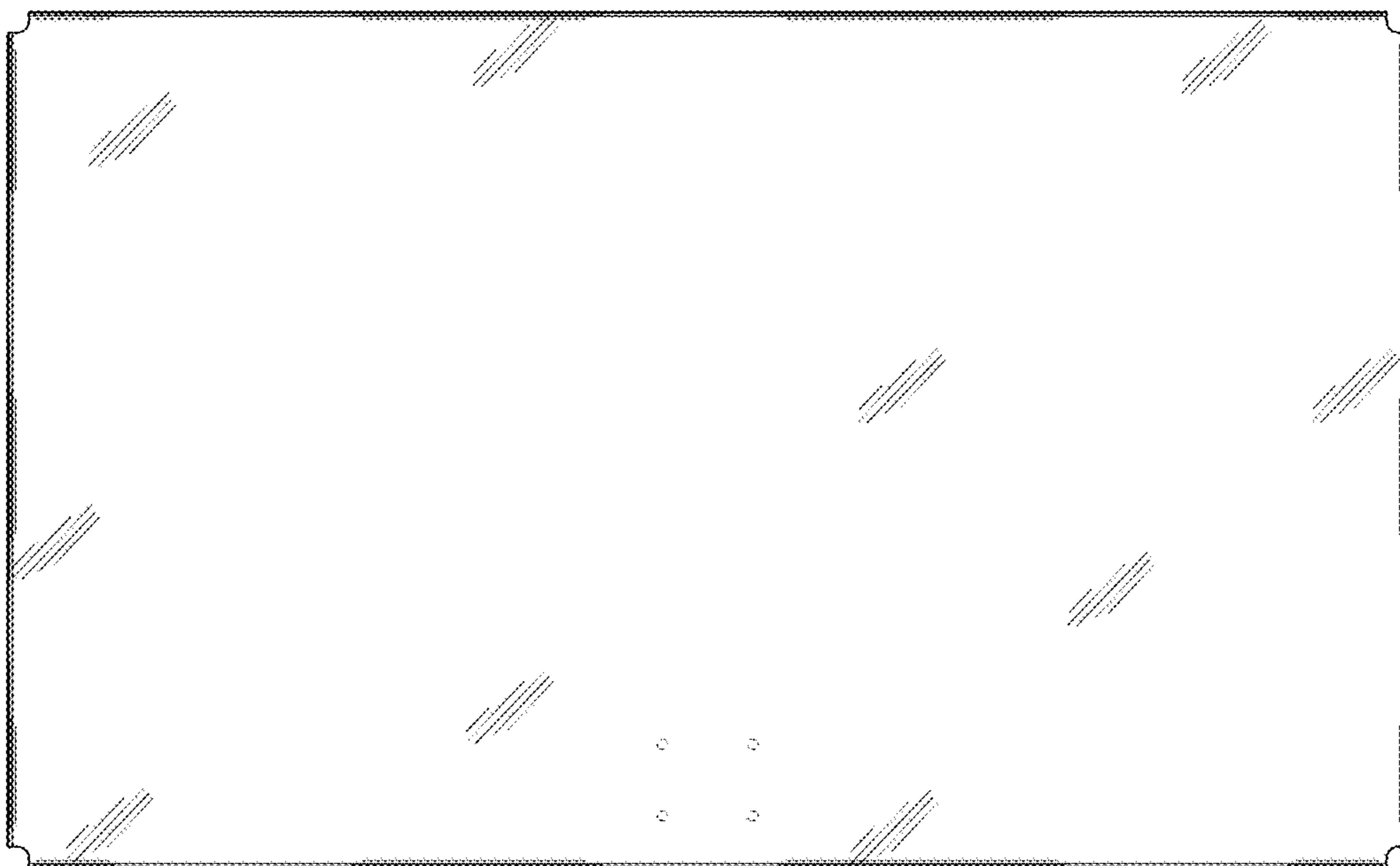

**Fig. 4**

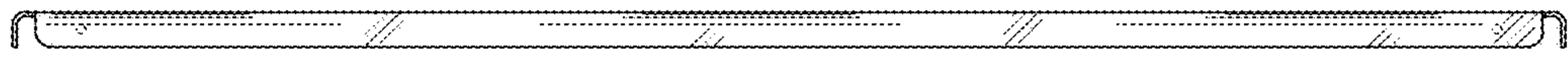

**Fig. 5**

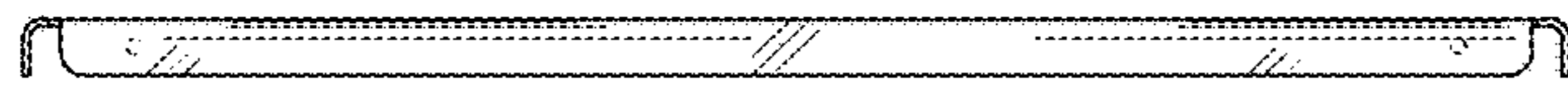

**Fig. 6**