



US00D817369S

(12) **United States Design Patent** (10) **Patent No.:** **US D817,369 S**
Kim (45) **Date of Patent:** **** May 8, 2018**

(54) **REFRIGERATOR**

(71) Applicant: **LG ELECTRONICS INC.**, Seoul (KR)

(72) Inventor: **Miok Kim**, Seoul (KR)

(73) Assignee: **LG Electronics Inc.**, Seoul (KR)

(**) Term: **15 Years**

(21) Appl. No.: **35/501,636**

(22) Filed: **Mar. 31, 2016**

(80) **Hague Agreement Data**

Int. Filing Date: **Mar. 31, 2016**

Int. Reg. No.: **DM/091794**

Int. Reg. Date: **Mar. 31, 2016**

Int. Reg. Pub. Date: **Sep. 30, 2016**

(30) **Foreign Application Priority Data**

Oct. 8, 2015 (KR) 30-2015-0050865

(51) **LOC (11) Cl.** **15-07**

(52) **U.S. Cl.**

USPC **D15/91**

CPC **F25D 23/00** (2013.01)

(58) **Field of Classification Search**

USPC D15/79-91

CPC F25D 23/00; F25D 2323/021; F25D 11/00;

F25D 2323/024; F25D 23/04; F25D

25/024; F25D 27/005; F25D 23/12; F25D

29/005; F25D 17/042; F25D 2325/021

See application file for complete search history.

(56) **References Cited**

U.S. PATENT DOCUMENTS

D615,565 S * 5/2010 Kristiansen D15/86

D629,022 S * 12/2010 Cho D15/85

D656,967 S * 4/2012 Yi D15/86
D673,189 S * 12/2012 Kwak D15/86
D681,075 S * 4/2013 Yi D15/86
D691,644 S * 10/2013 Cho D15/86
D701,539 S * 3/2014 Saejin D15/85
D702,739 S * 4/2014 Kim D15/86
D724,629 S * 3/2015 Choi D15/85
D729,286 S * 5/2015 Kwak D15/85
D732,584 S * 6/2015 Sin D15/86
D742,434 S * 11/2015 Yeo D15/86
D767,648 S * 9/2016 Shoemaker D15/86

* cited by examiner

Primary Examiner — Richard E Chilcot

(74) *Attorney, Agent, or Firm* — Birch, Stewart, Kolasch & Birch, LLP

(57) **CLAIM**

The ornamental design for a refrigerator, as shown and described.

DESCRIPTION

1. Refrigerator

1.1 is a perspective view of a refrigerator showing our new design;

1.2 is a front elevation view thereof;

1.3 is a rear elevation view thereof;

1.4 is a left-side elevation view thereof;

1.5 is a right-side elevation view thereof;

1.6 is a top plan view thereof;

1.7 is a bottom plan view thereof;

1.8 is another perspective view thereof, wherein the inside of the door is seen through a 'see-through' type of window.

1.9 is another perspective view thereof, wherein the outer door is in an opened position; and,

1.10 is another perspective view thereof, wherein each of the inner and outer doors is in an opened position.

The broken lines shown in figures **1.1-1.10** depict unclaimed portions of the refrigerator and form no part of the claimed design.

1 Claim, 9 Drawing Sheets

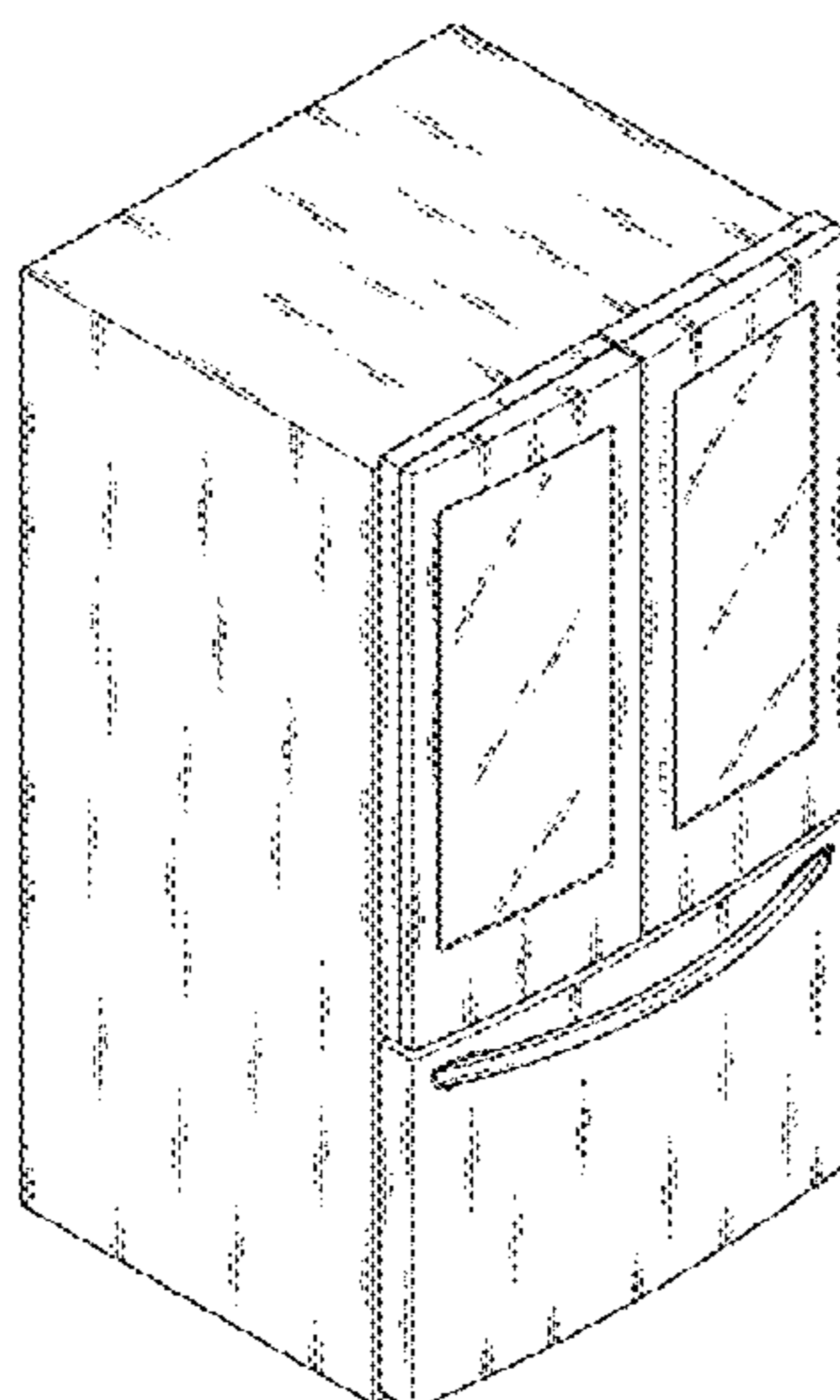

1.1

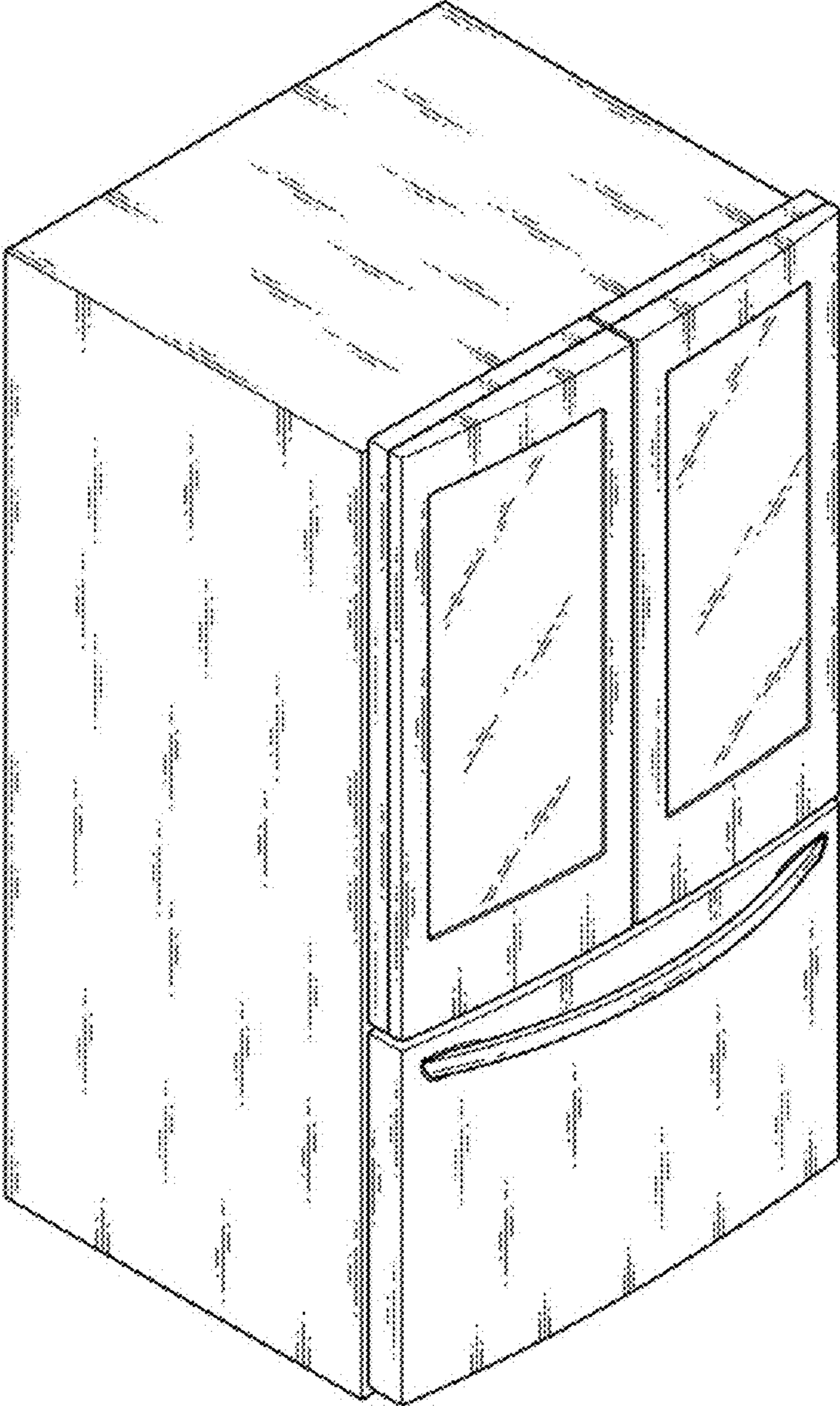

1.2

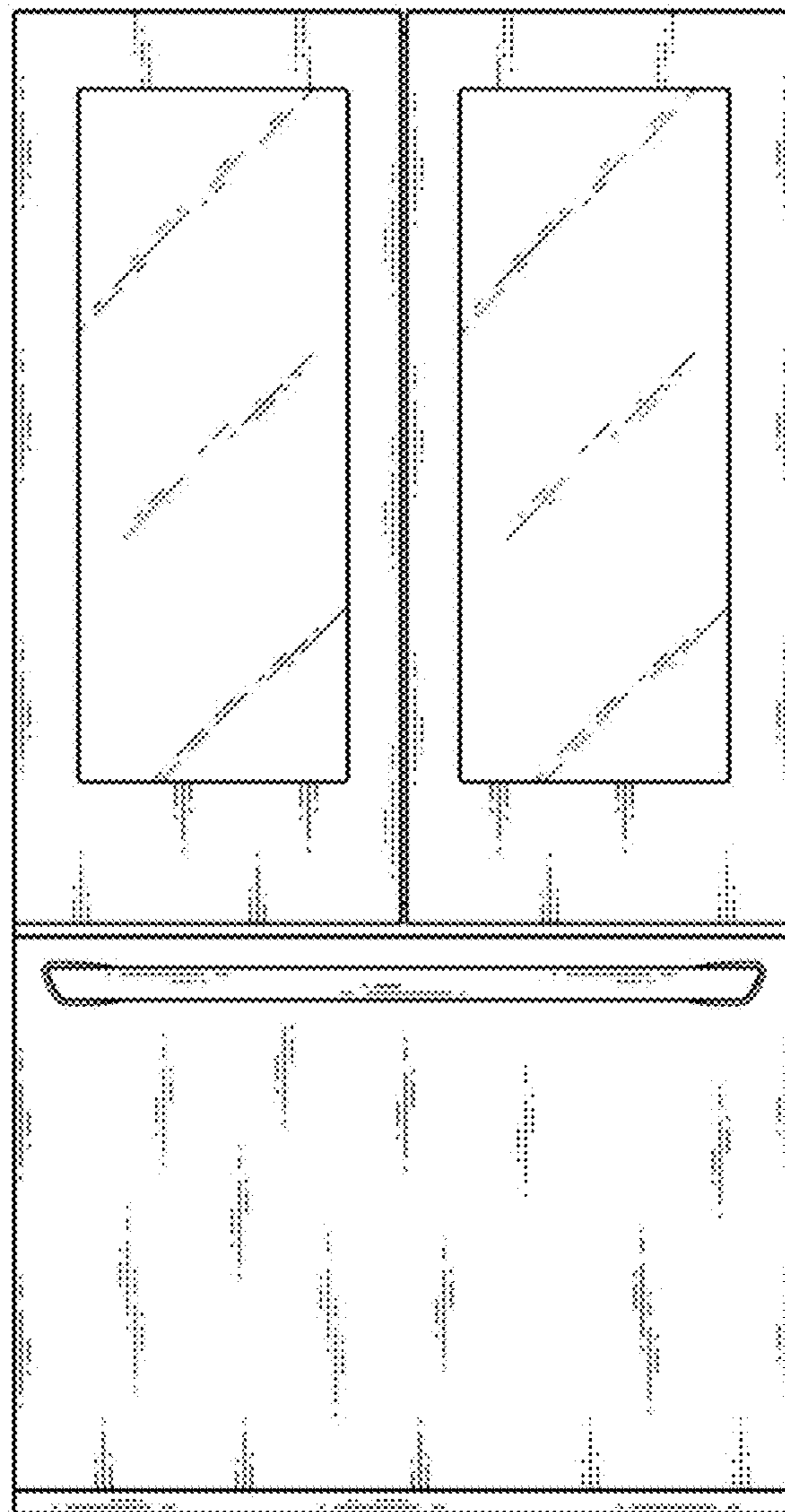

1.3

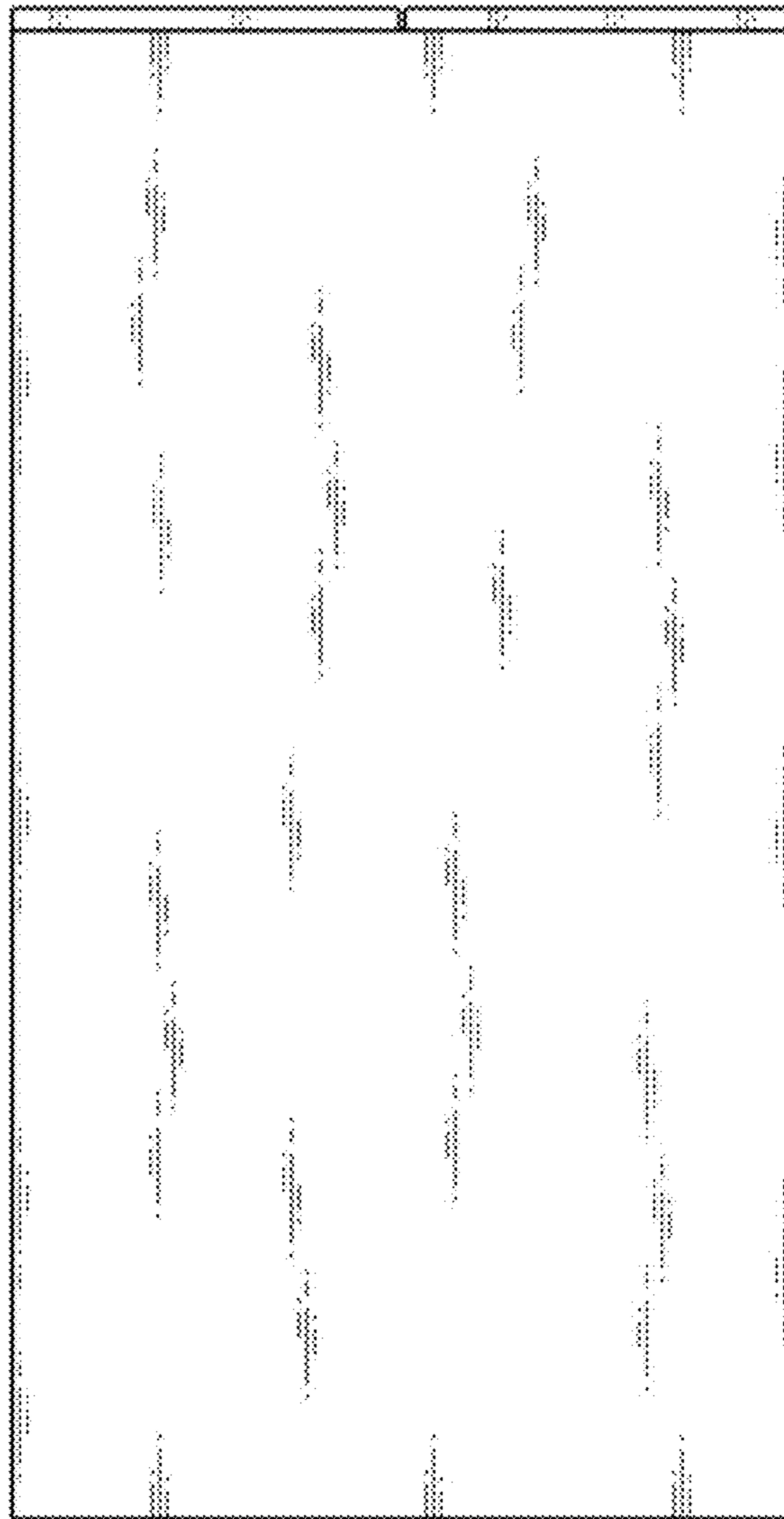

1.4

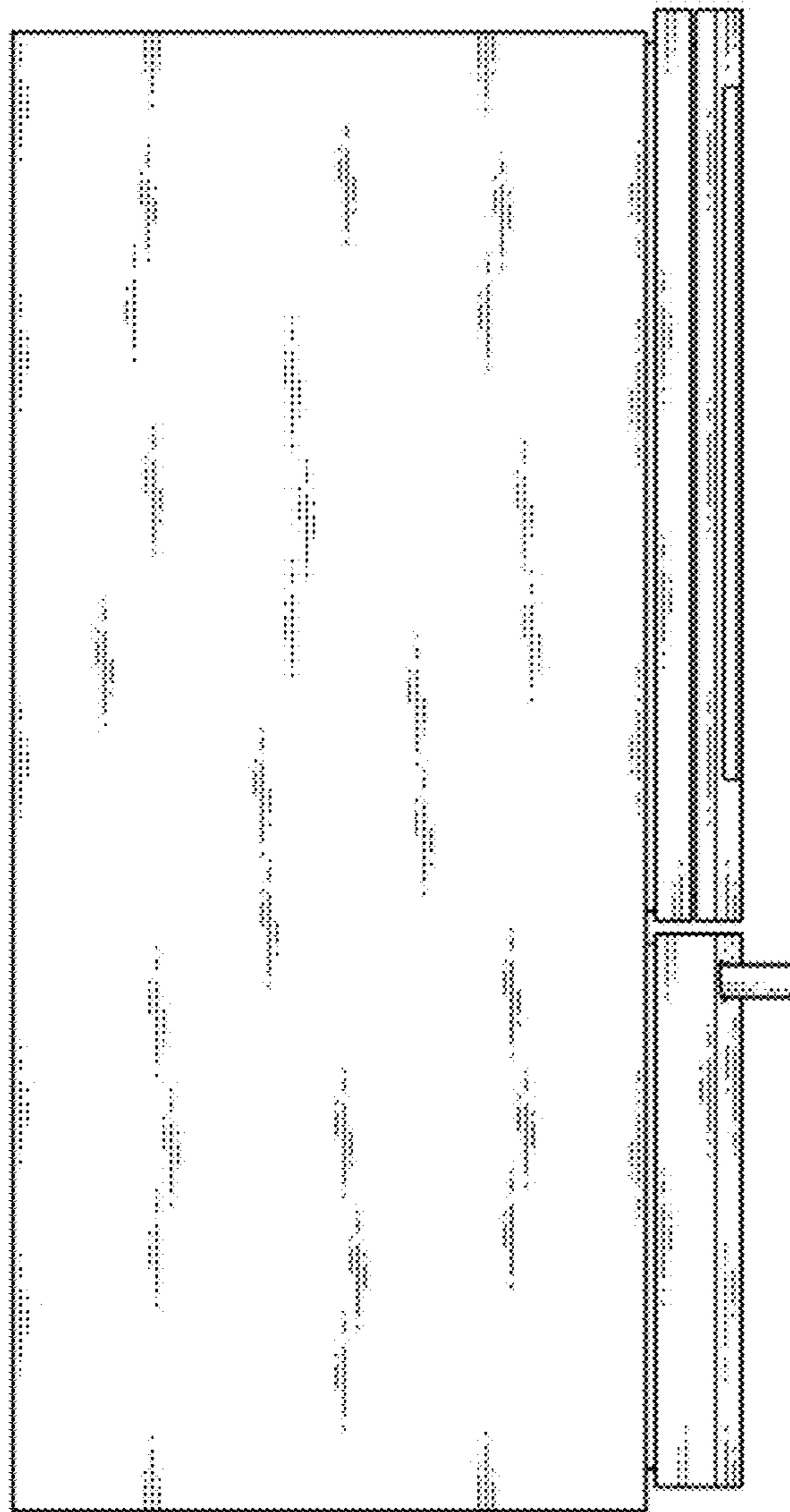

1.5

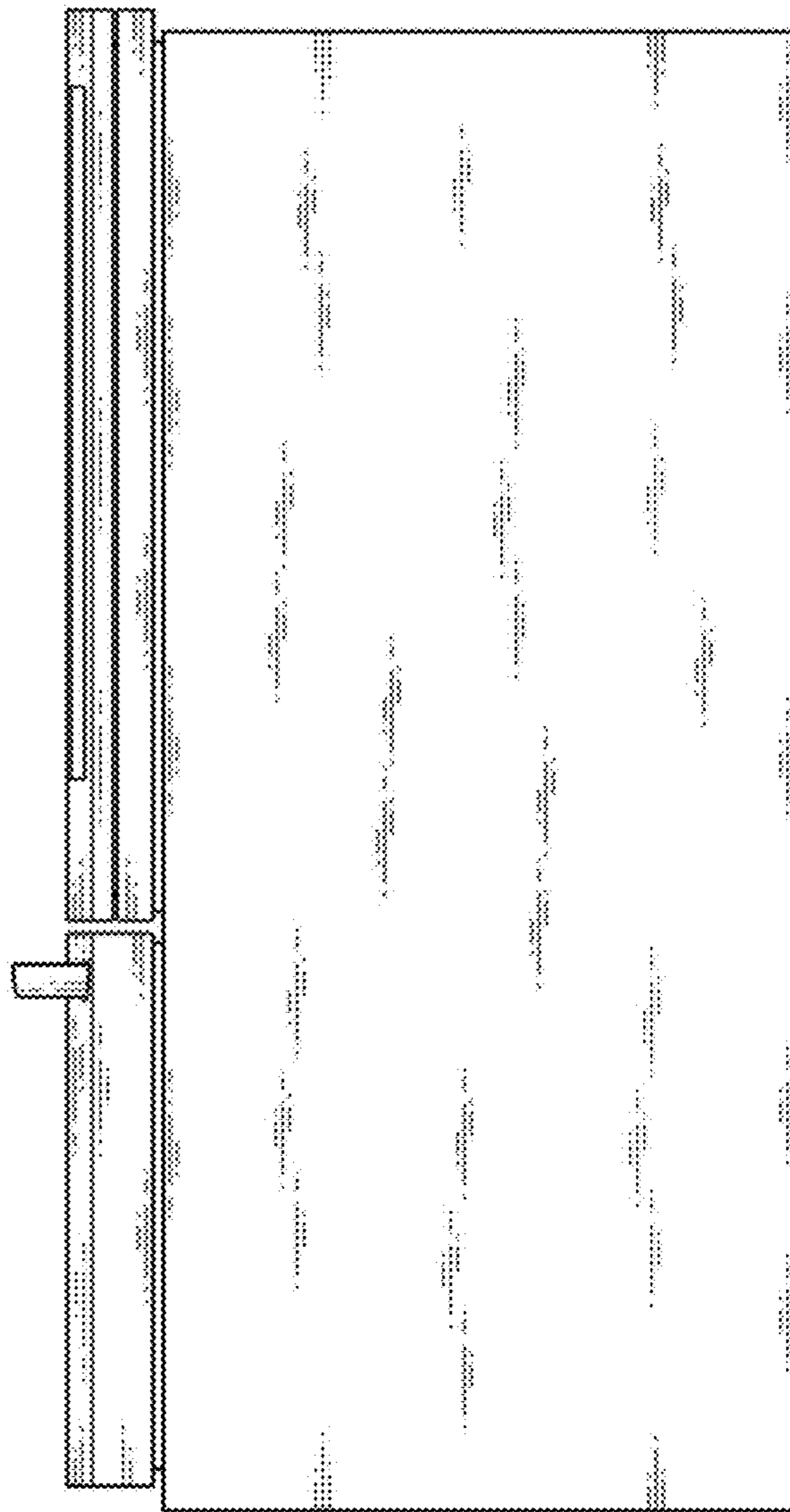

1.6

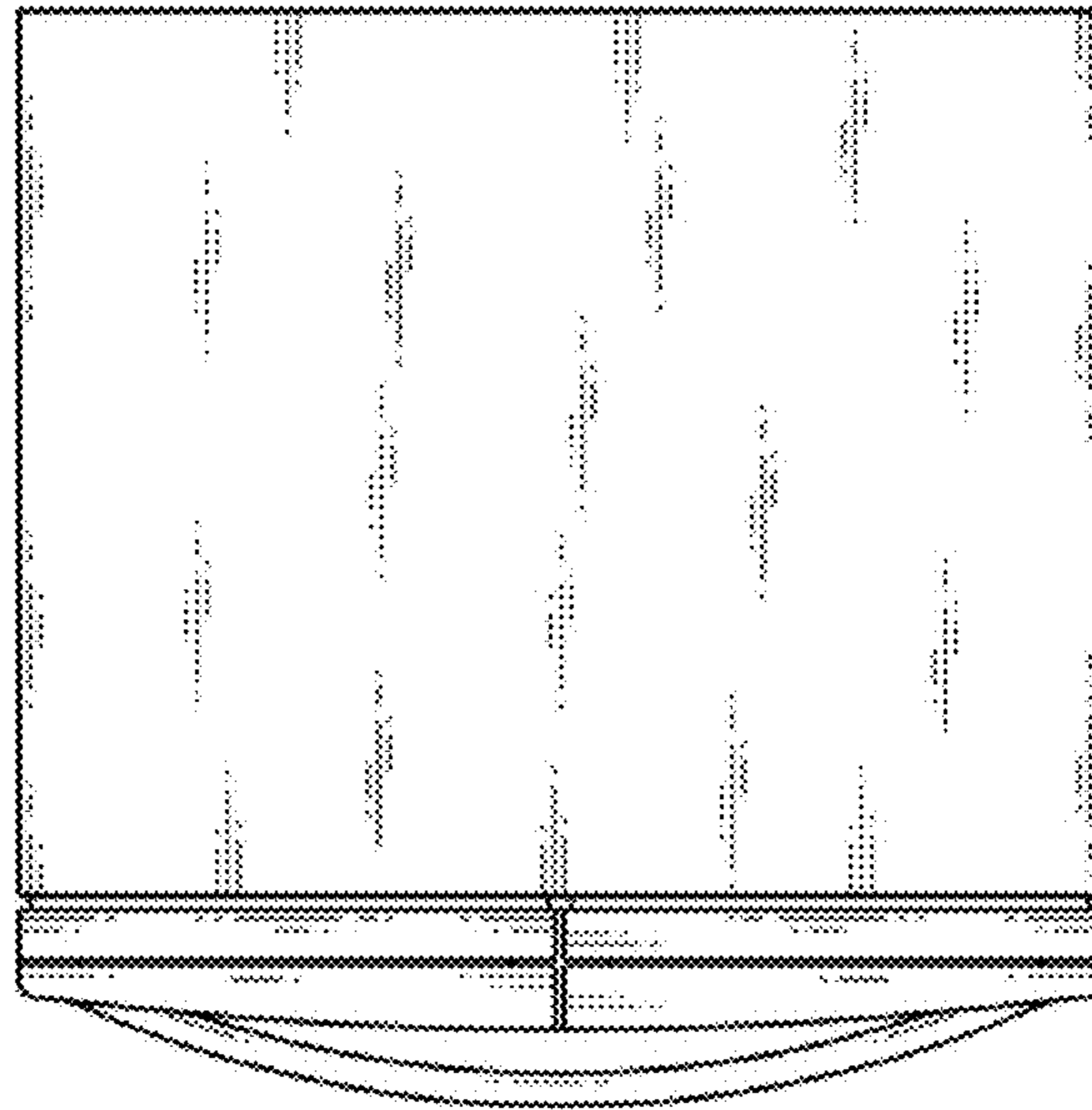

1.7

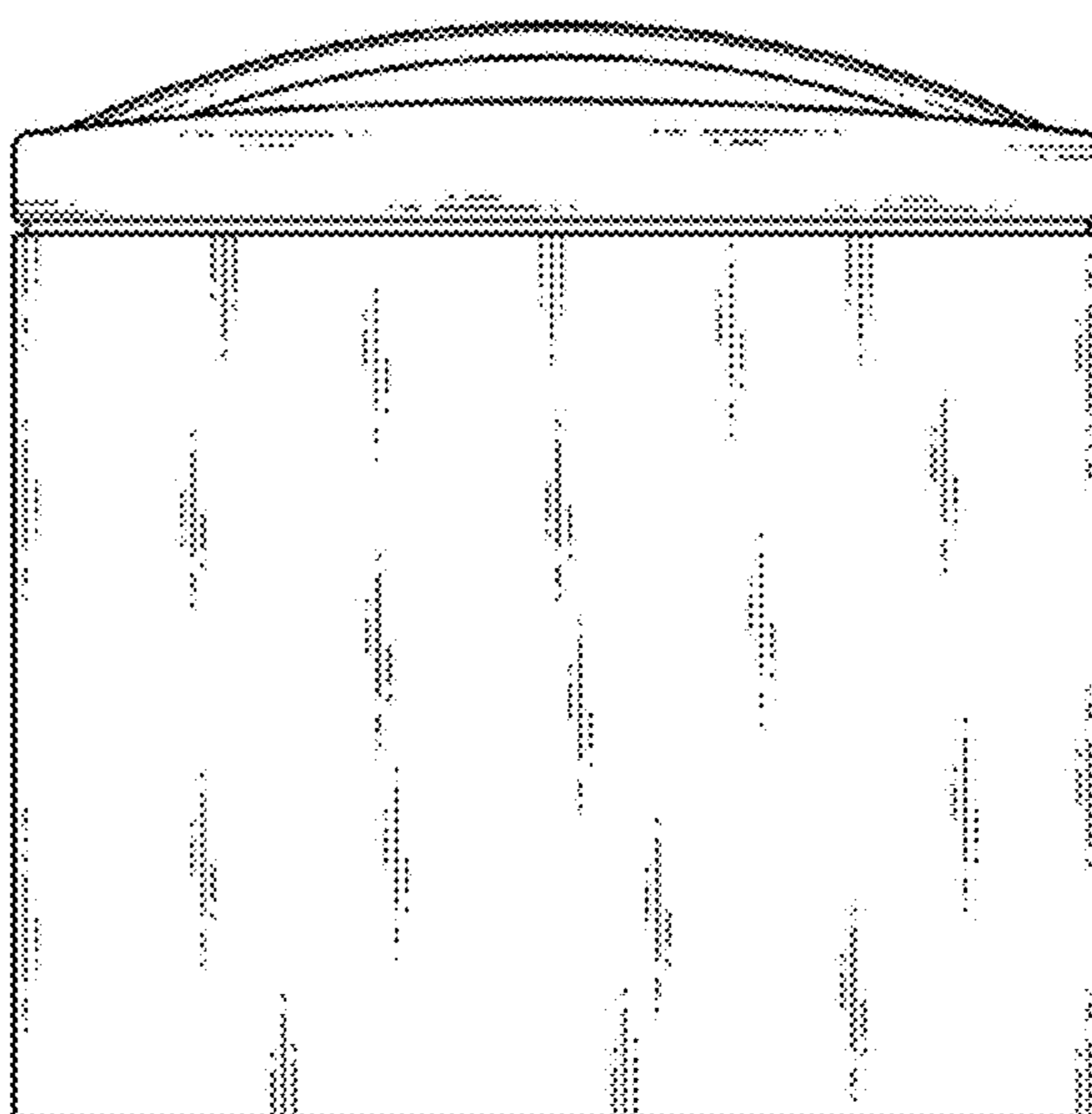

1.8

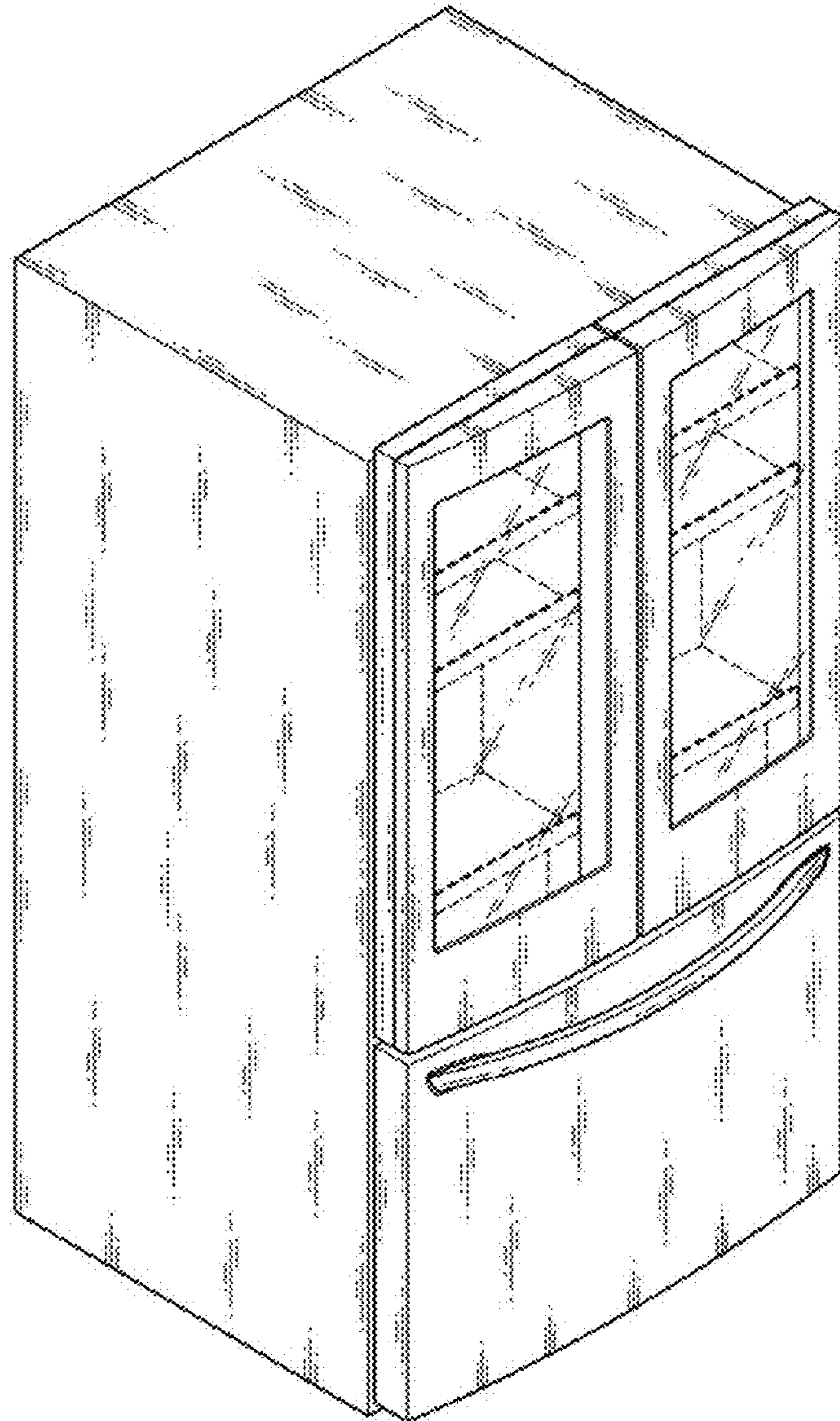

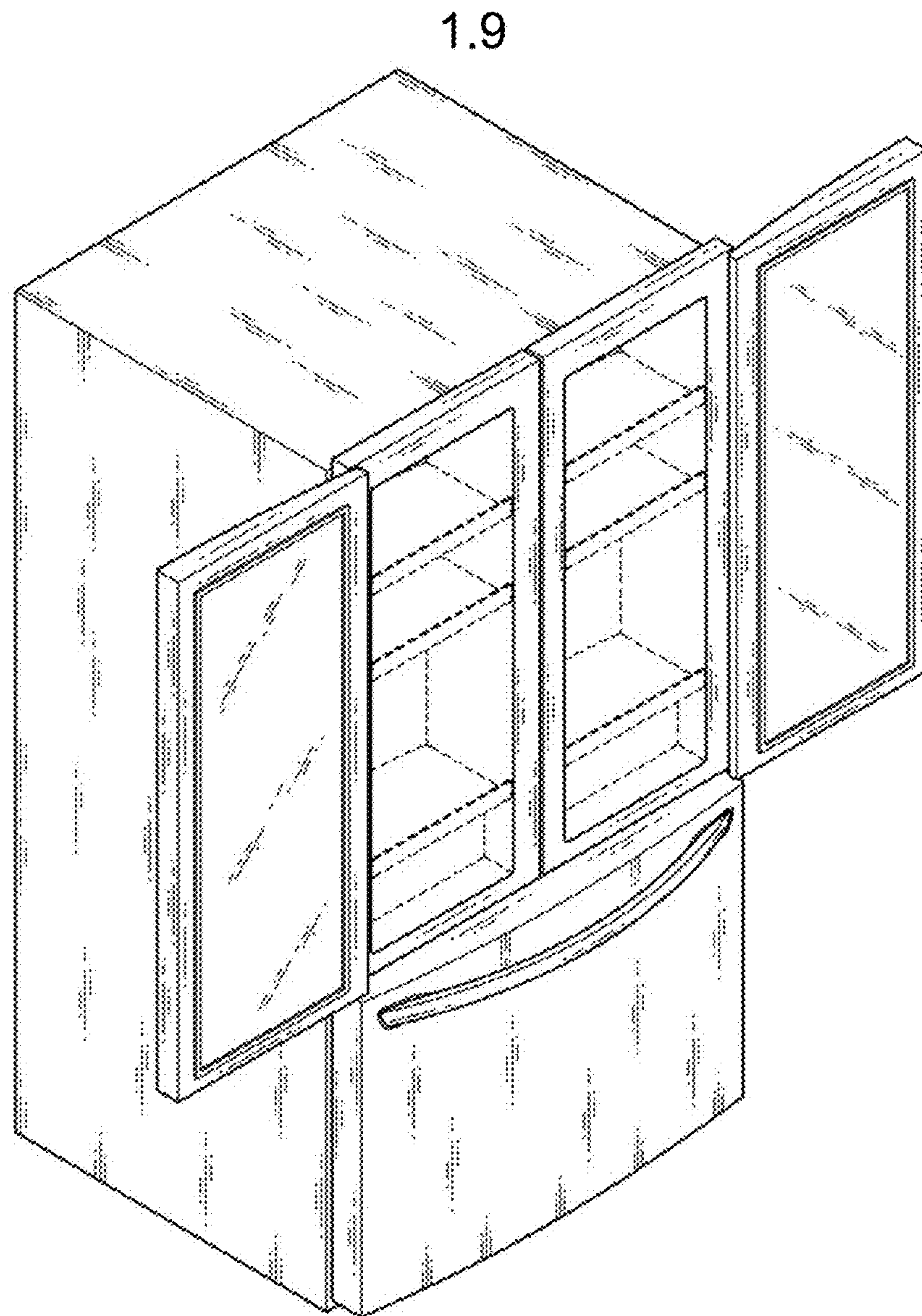

1.10

