



US00D817186S

(12) **United States Design Patent** (10) **Patent No.:** **US D817,186 S**
Blake (45) **Date of Patent:** **** May 8, 2018**

(54) **DEODORANT DISPENSER**

(71) Applicant: **Kickstart Logic, LLC**, Kansas City, MO (US)

(72) Inventor: **James Blake**, Kansas City, MO (US)

(73) Assignee: **Kickstart Logic, LLC**, Kansas City, MO (US)

(**) Term: **15 Years**

(21) Appl. No.: **29/581,998**

(22) Filed: **Oct. 24, 2016**

(51) **LOC (11) Cl.** **09-01**

(52) **U.S. Cl.**
USPC **D9/727**

(58) **Field of Classification Search**
USPC D9/522, 529-530, 539, 549, 558, 723,
D9/724, 726-729; 222/386, 390;
401/68, 75, 172, 175
CPC A45D 40/04; A45D 40/16; A61K 8/28;
A61K 8/342; A61K 8/732
See application file for complete search history.

(56) **References Cited**

U.S. PATENT DOCUMENTS

D248,373 S *	7/1978	Allen	D7/511
D372,872 S *	8/1996	Crawford	D9/449
5,725,133 A *	3/1998	Iaia	A45D 40/04
				222/390
5,879,096 A *	3/1999	Franta	A45D 40/04
				222/390
5,947,621 A *	9/1999	Szekely	A45D 40/16
				401/175
D430,279 S *	8/2000	Bunce	D23/366

(Continued)

Primary Examiner — Derrick E Holland
Assistant Examiner — Janice Julia Patyk

(74) *Attorney, Agent, or Firm* — Hovey Williams LLP

(57) **CLAIM**

The ornamental design for a deodorant dispenser, as shown and described.

DESCRIPTION

FIG. 1 is a top, front perspective view of embodiment one, of a deodorant dispenser, showing my new design; FIG. 2 is a bottom, rear perspective view thereof; FIG. 3 is a front elevation view thereof; FIG. 4 is a right side elevation view thereof, with the left side elevation view being a mirror image thereof; FIG. 5 is a rear elevation view thereof; FIG. 6 is a top view thereof; FIG. 7 is a bottom view thereof; FIG. 8 is a top, front perspective of embodiment two, of a deodorant dispenser, shown without the cap for ease of illustration, showing my new design; FIG. 9 is a bottom, rear perspective view thereof; FIG. 10 is a front elevation view thereof; FIG. 11 is a right side elevation view thereof, with the left side elevation view being a mirror image thereof; FIG. 12 is a rear elevation view thereof; FIG. 13 is a top view thereof; FIG. 14 is a bottom view thereof; FIG. 15 is a top, front perspective view of embodiment three, of a deodorant dispenser, shown without the body for ease of illustration, showing my new design; FIG. 16 is a bottom, rear perspective view thereof; FIG. 17 is a front elevation view thereof; FIG. 18 is a right side elevation view thereof, with the left side elevation view being a mirror image thereof; FIG. 19 is a rear elevation view thereof; FIG. 20 is a top view thereof; and, FIG. 21 is a bottom view thereof.

The broken dashed lines in the various Figures illustrate the portions of the design that form no part of the claimed design. The broken dashed-dotted lines shown in the various Figures illustrate the boundaries of the claimed surfaces of the claimed design.

1 Claim, 9 Drawing Sheets

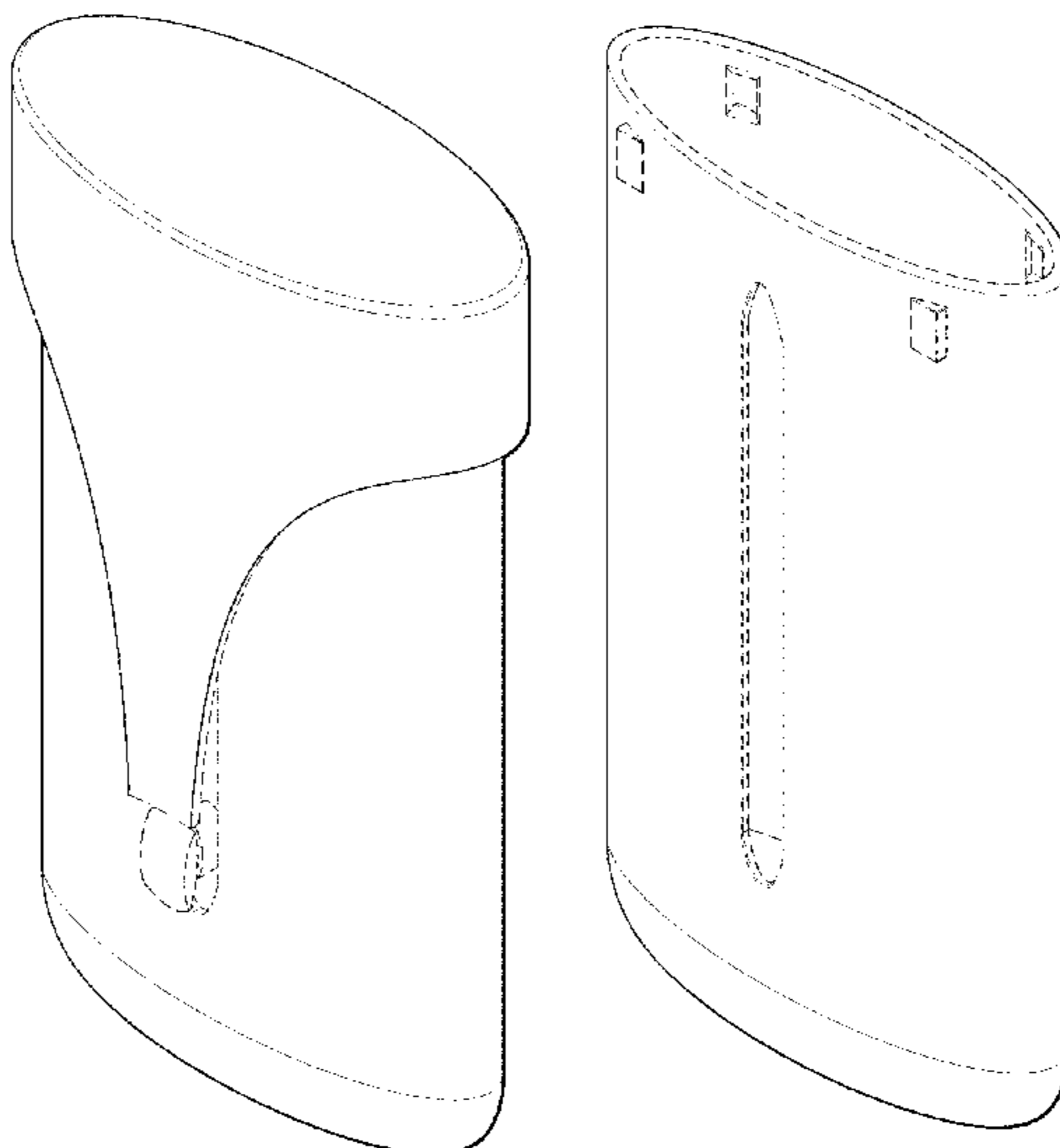

(56)

References Cited

U.S. PATENT DOCUMENTS

6,269,982 B1 * 8/2001 Kreiseder A45D 40/04
222/326
6,336,763 B1 * 1/2002 Losier A45D 40/04
401/205
D485,495 S * 1/2004 Cummings D9/529
D613,160 S * 4/2010 Ablo D9/436
D697,972 S * 1/2014 Jiang D19/194
8,714,402 B2 * 5/2014 Touchet B29C 65/08
220/613
8,875,955 B2 * 11/2014 Arora A45D 40/04
222/386
8,961,048 B2 * 2/2015 Baines A45D 40/04
401/172
2009/0162129 A1 * 6/2009 Ferrari A45D 40/265
401/122
2014/0154197 A1 * 6/2014 Swaile A45D 40/04
424/66

* cited by examiner

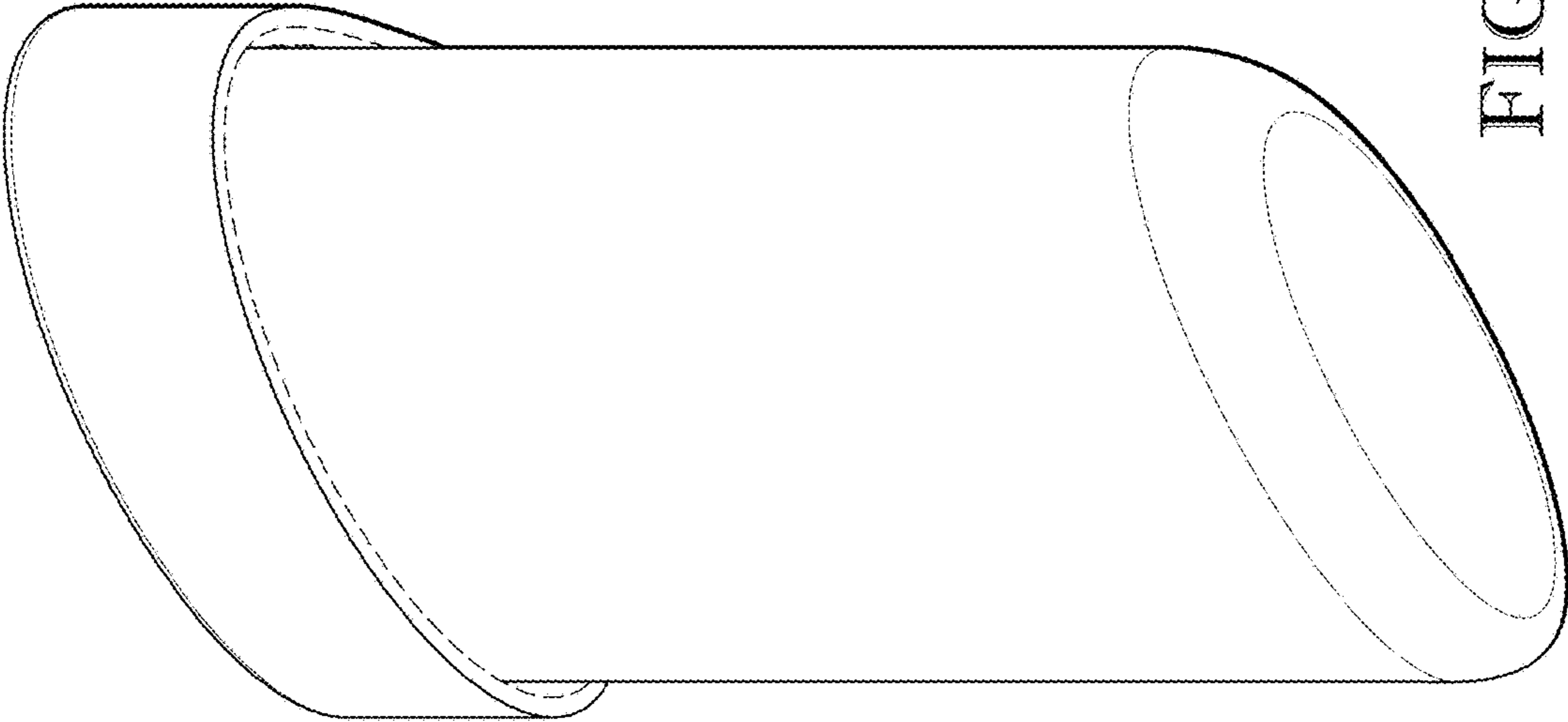

FIG. 2

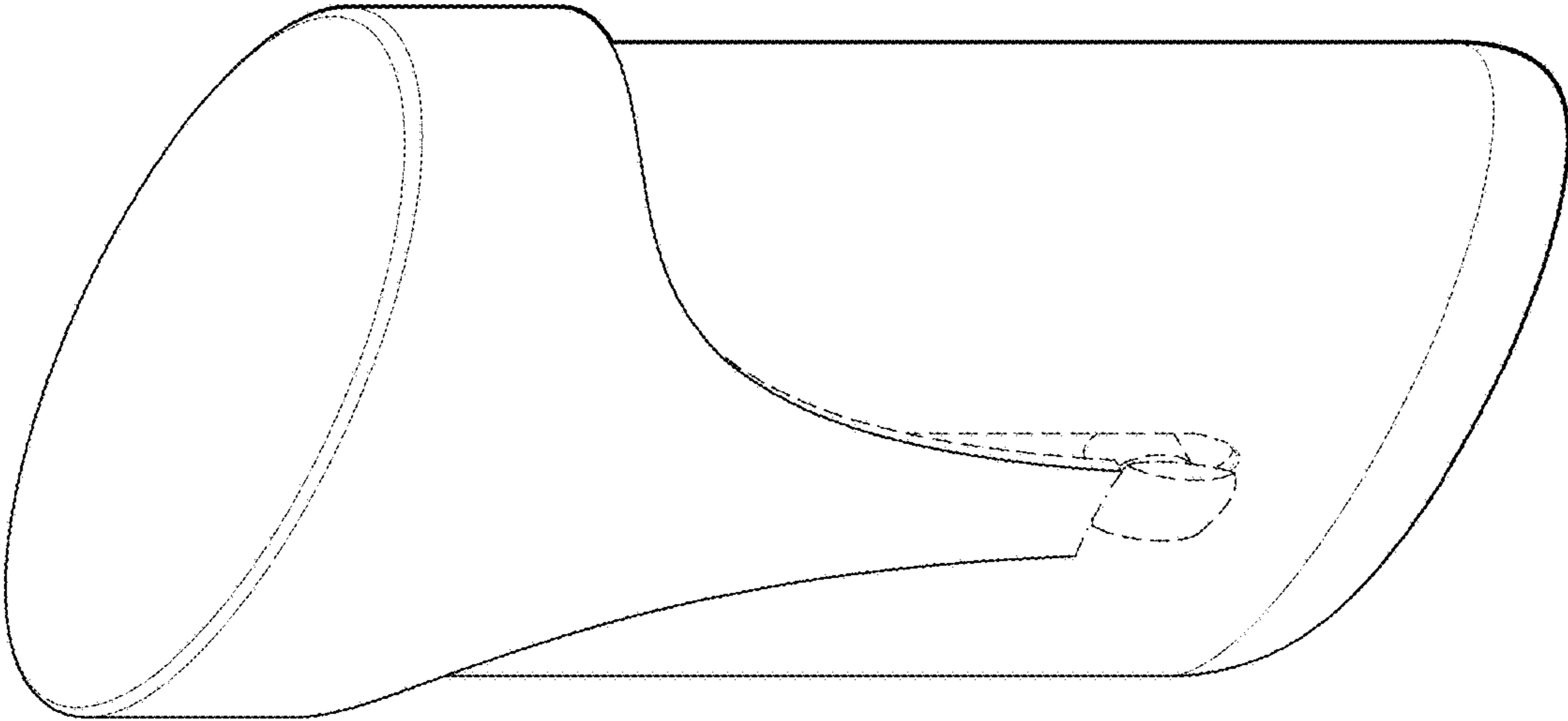

FIG. 1

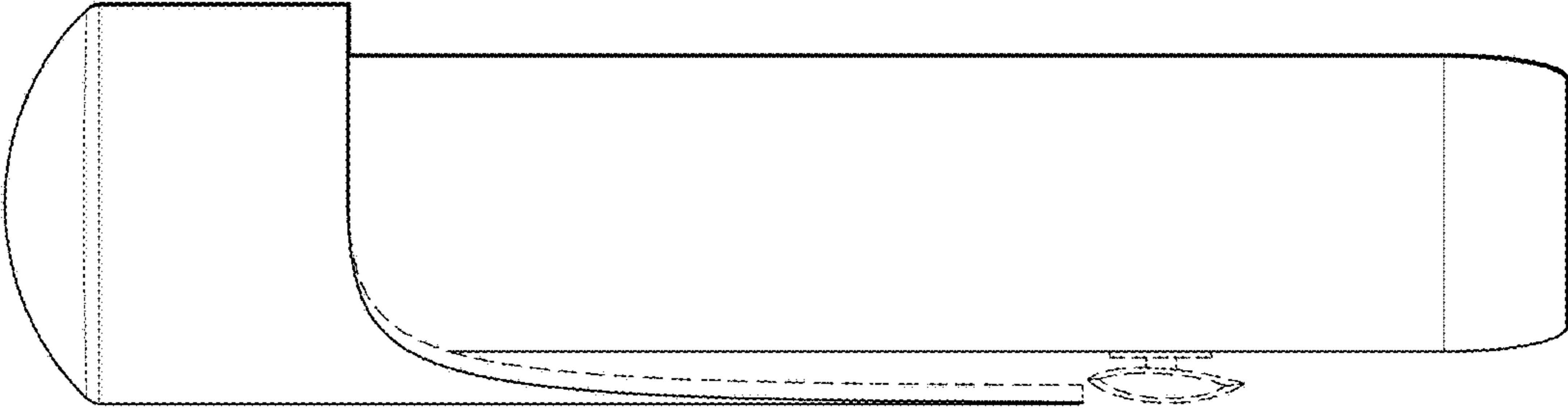

FIG. 4

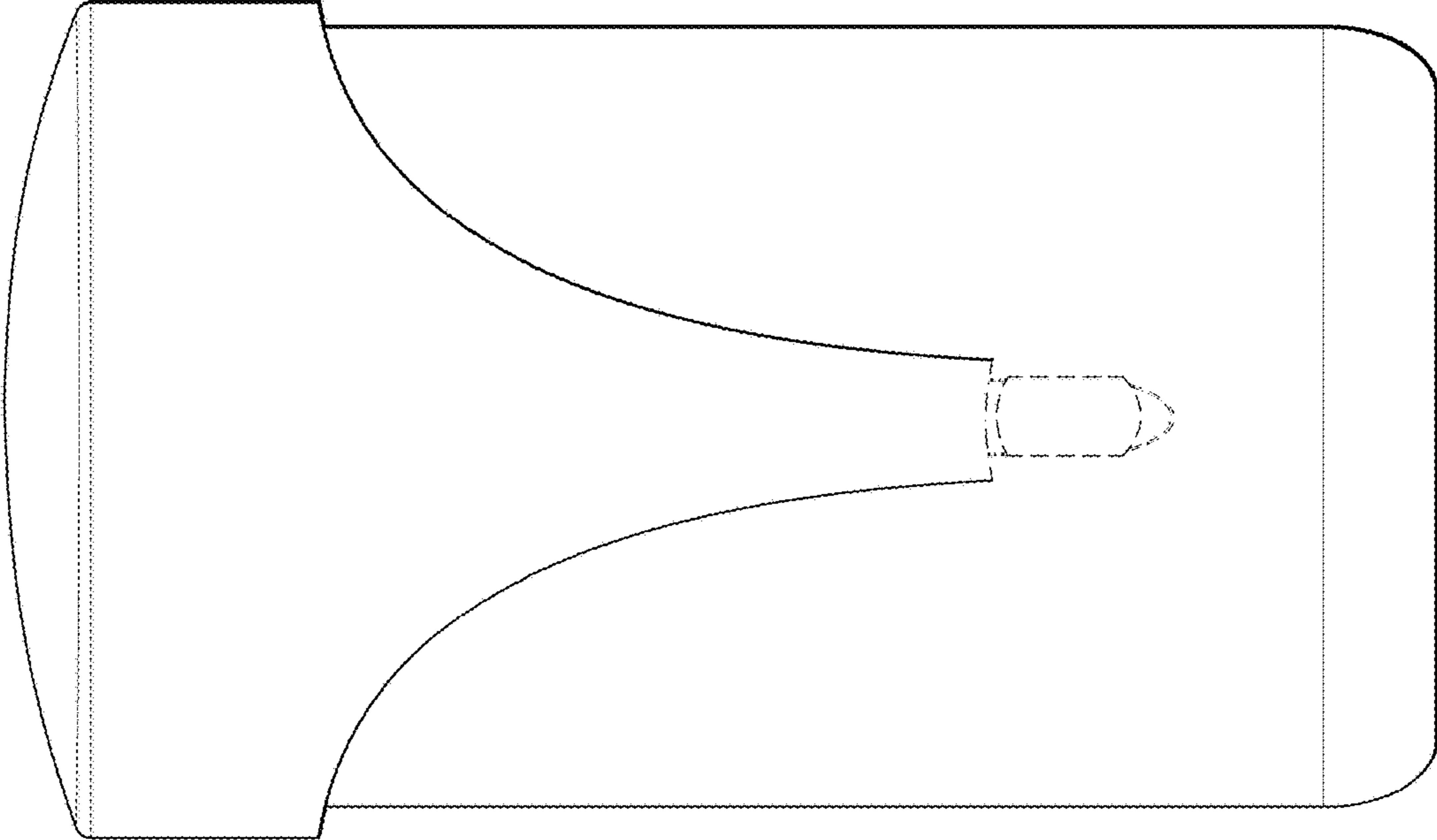

FIG. 3

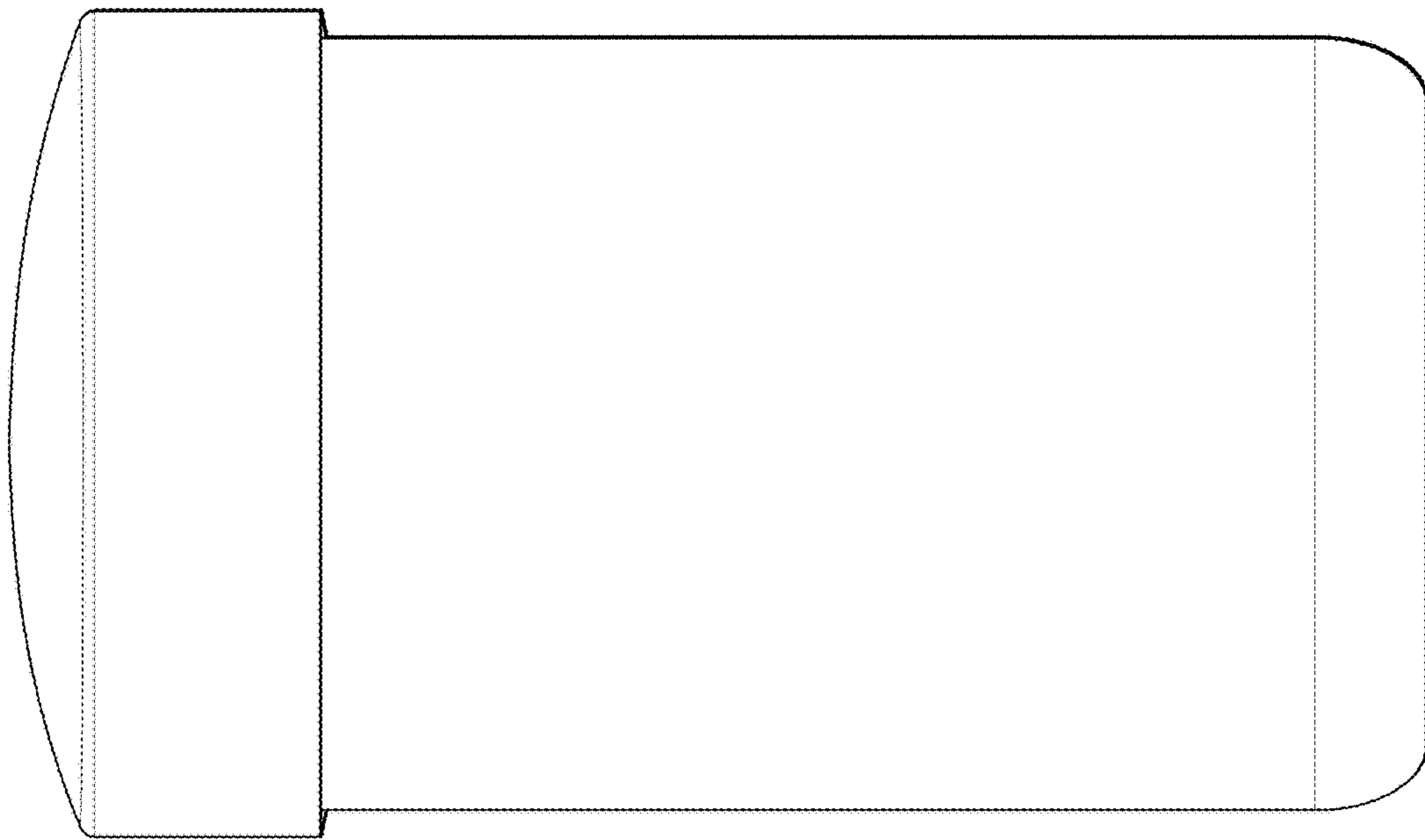

FIG. 5

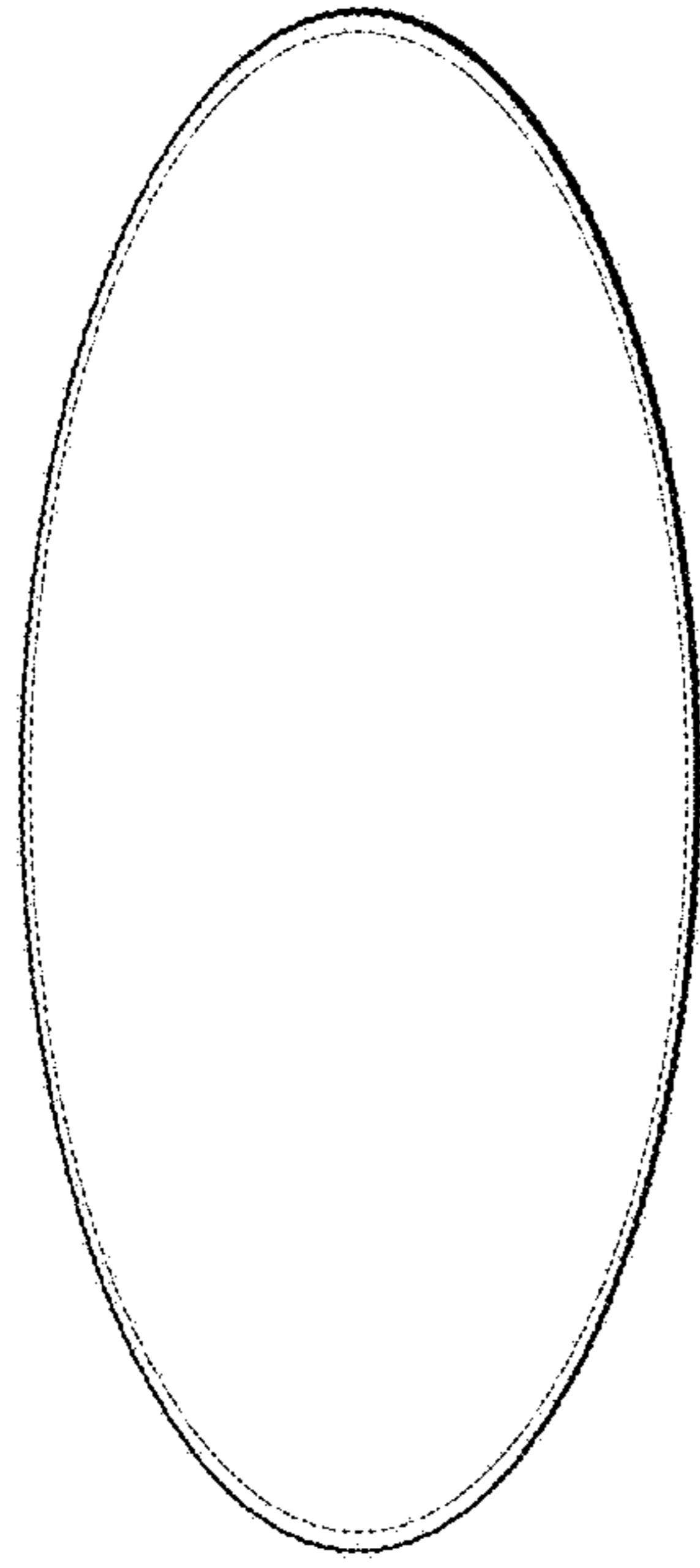

FIG. 6

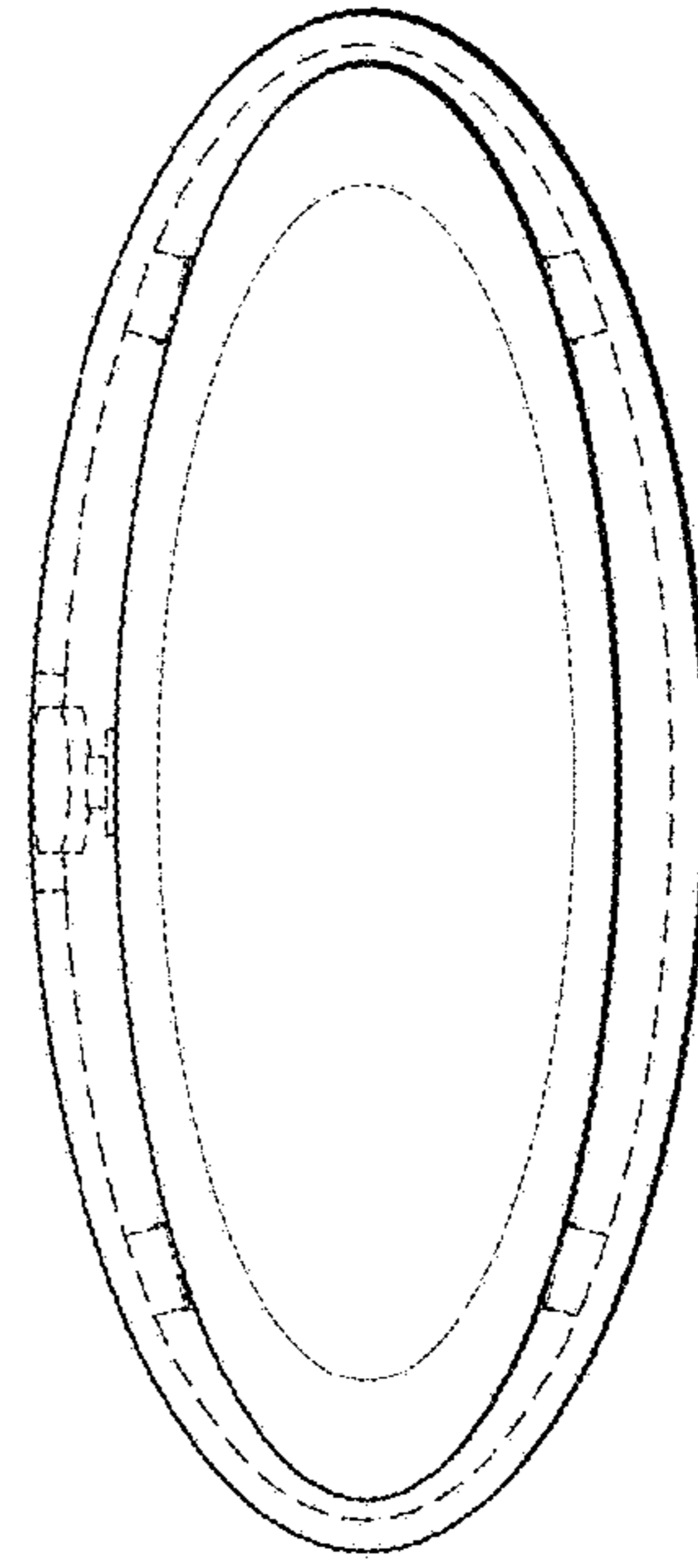

FIG. 7

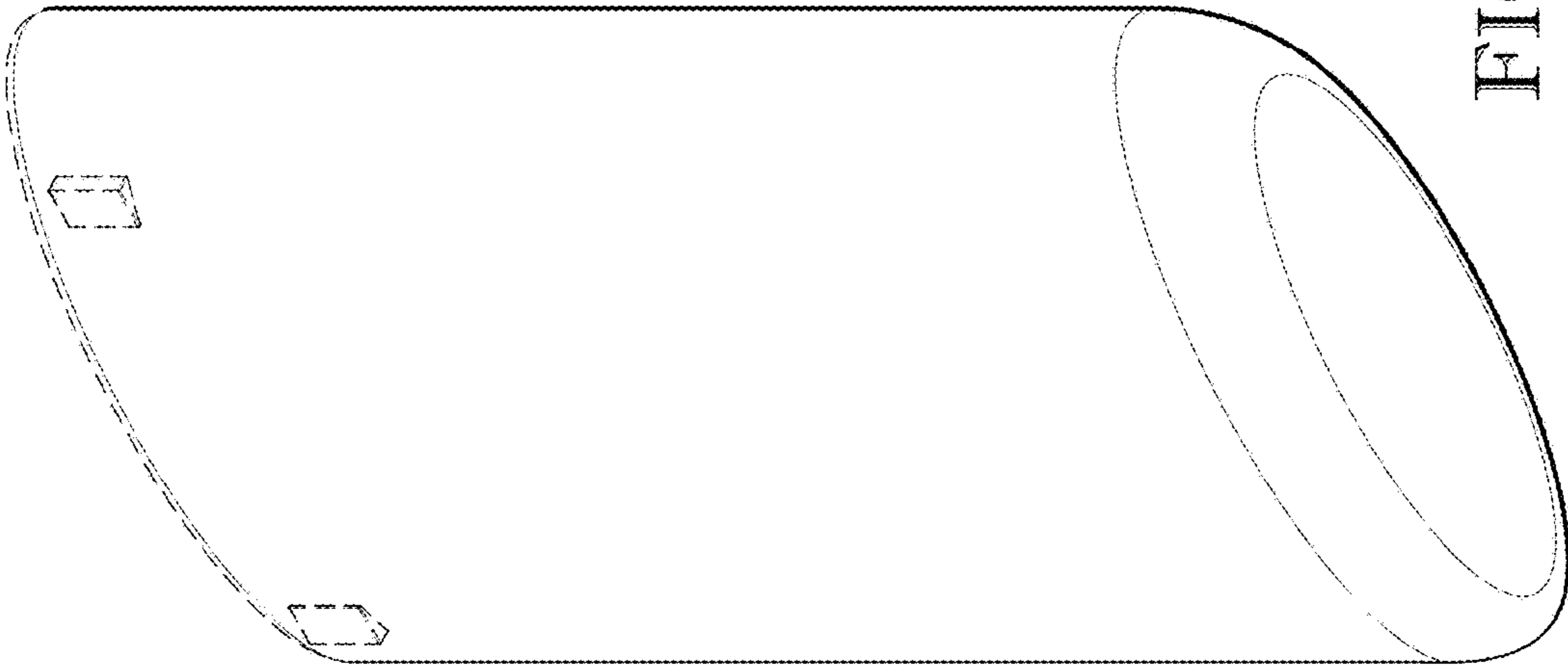

FIG. 9

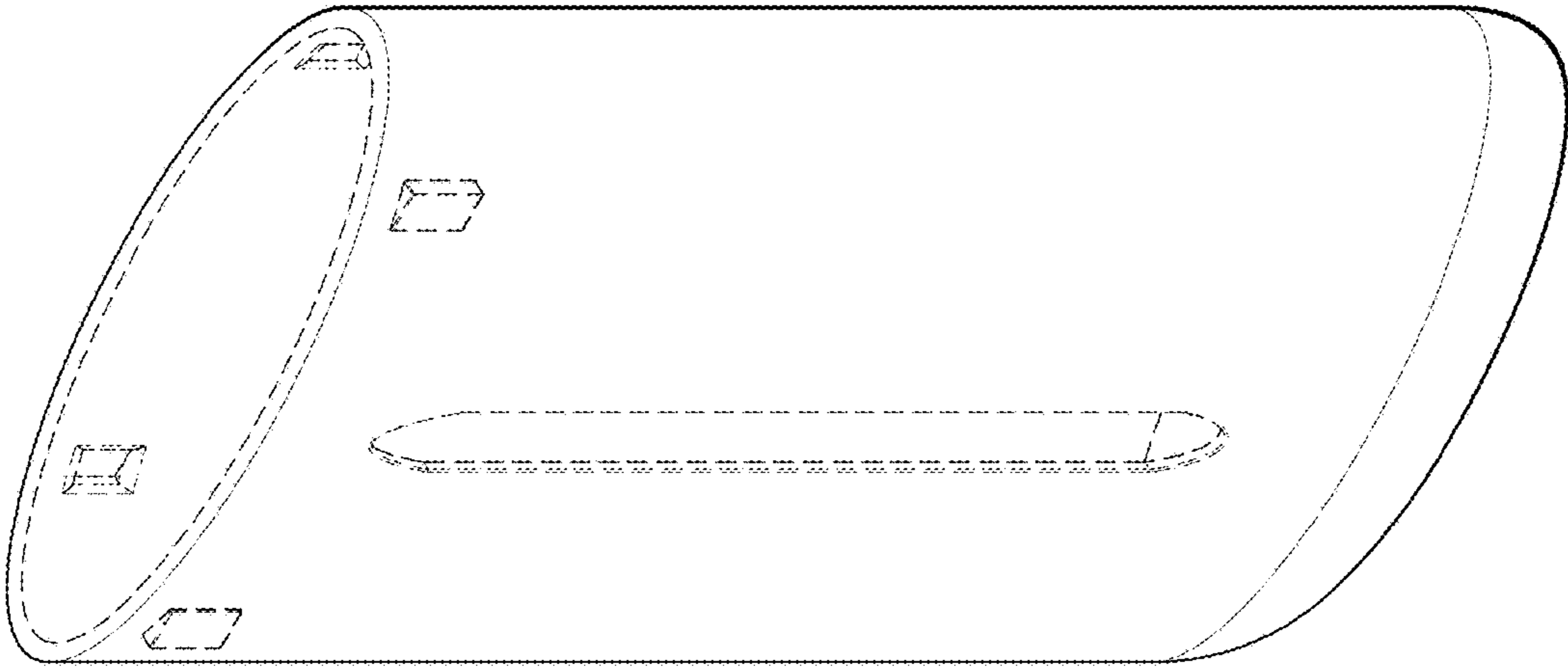

FIG. 8



FIG. 11

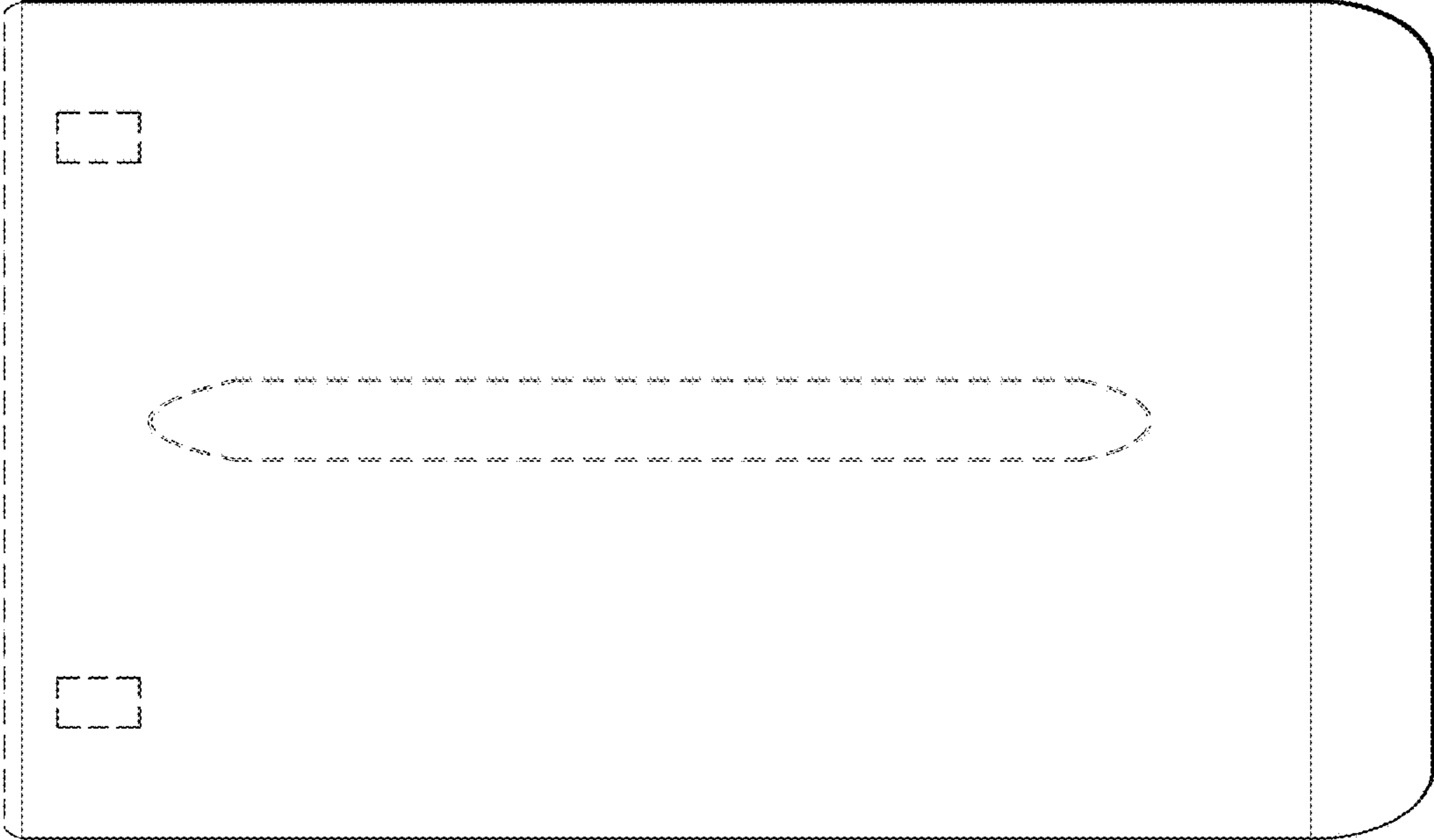

FIG. 10

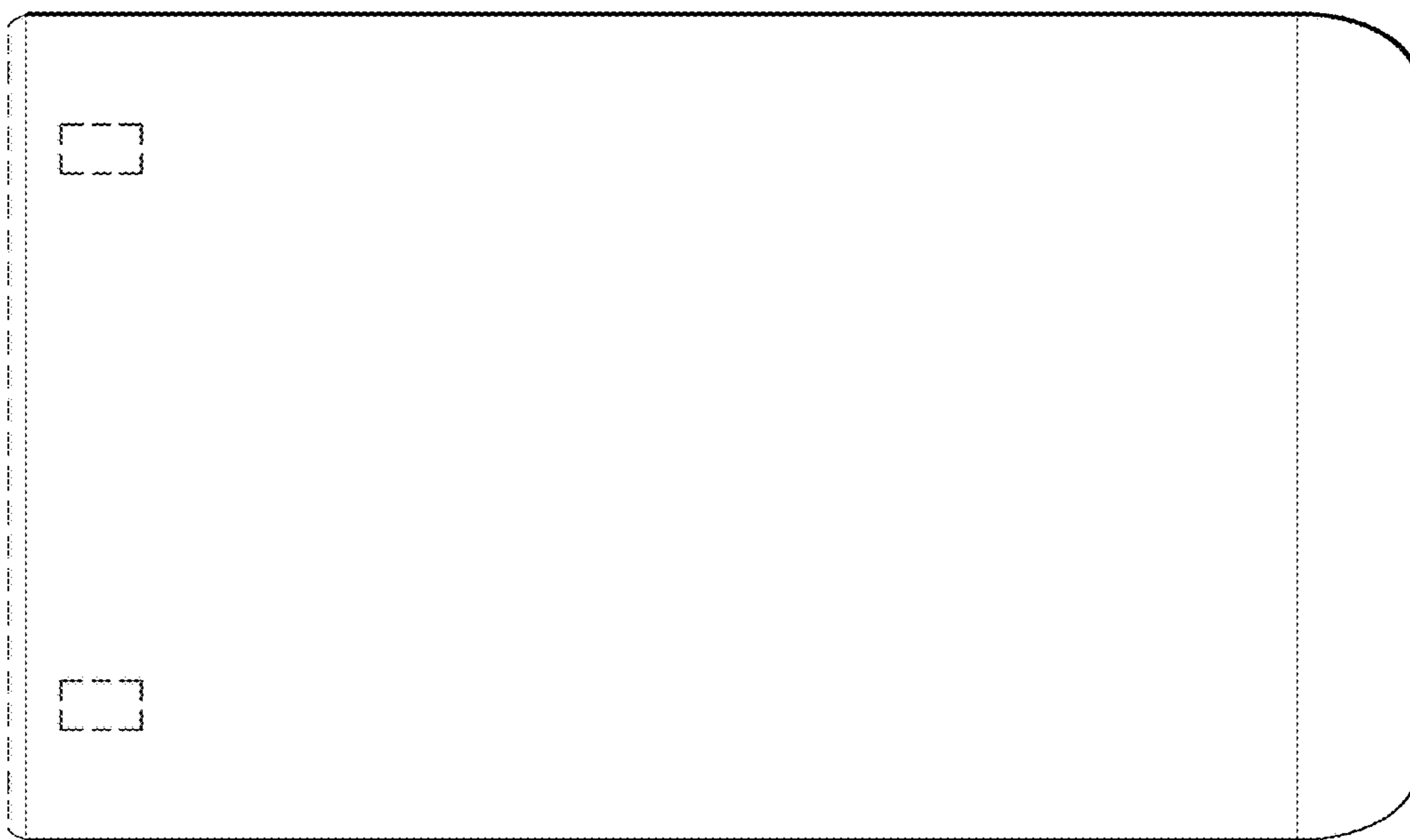

FIG. 12

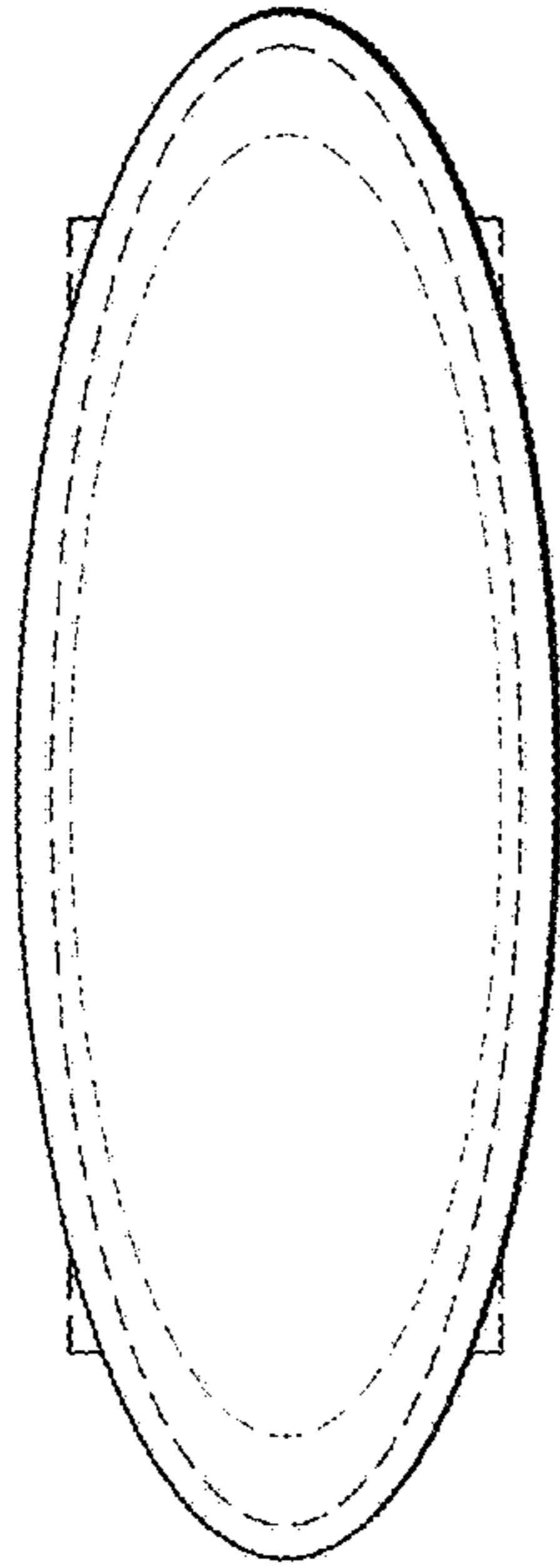

FIG. 13

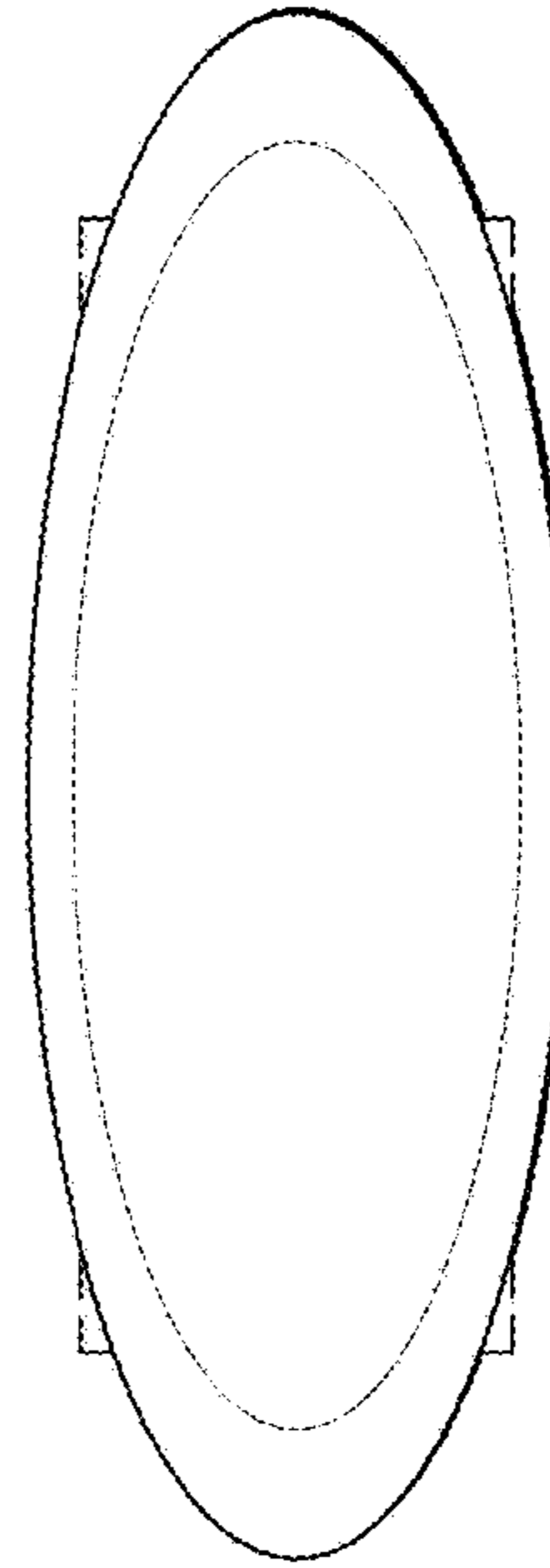

FIG. 14

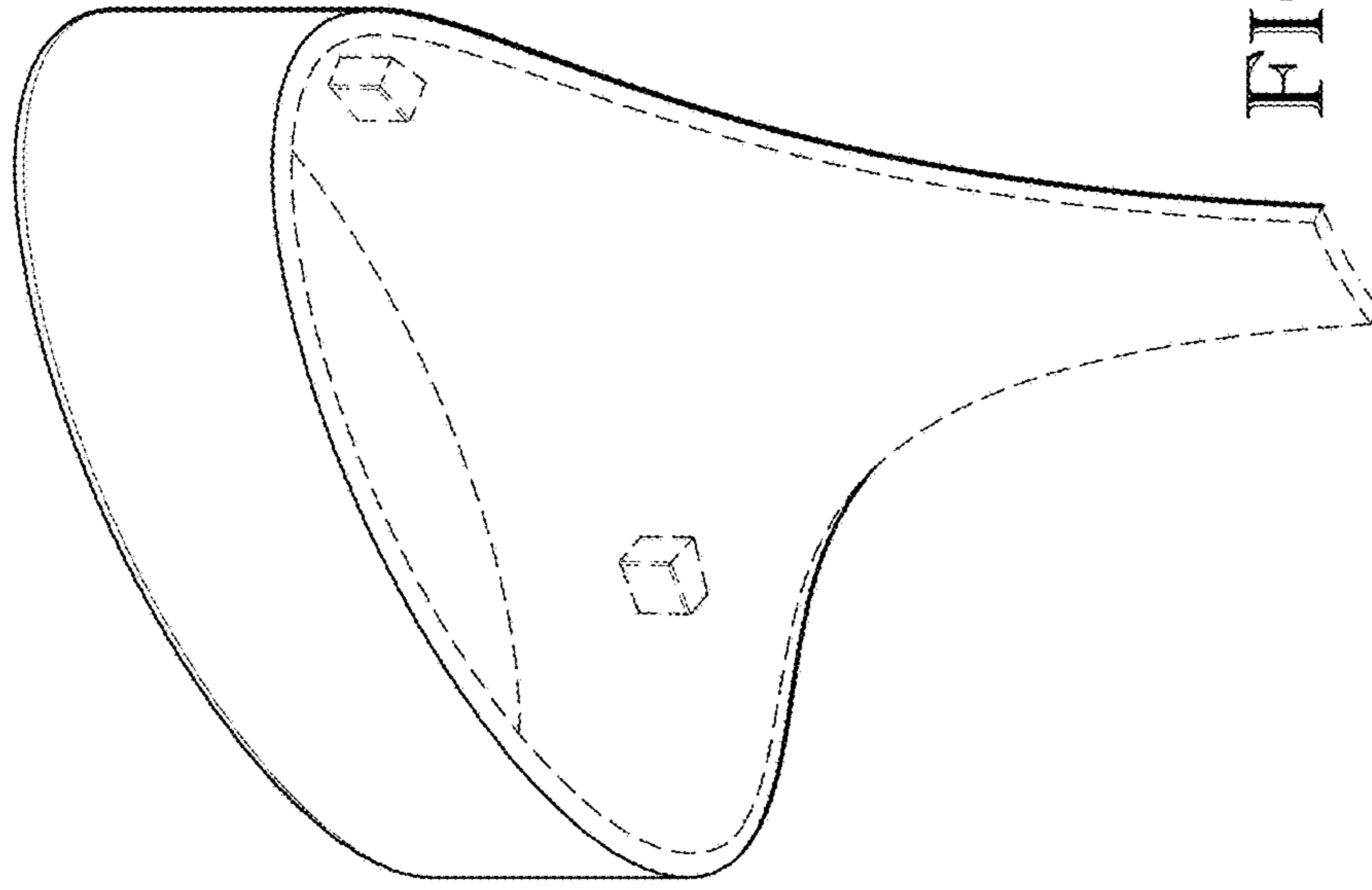

FIG. 16

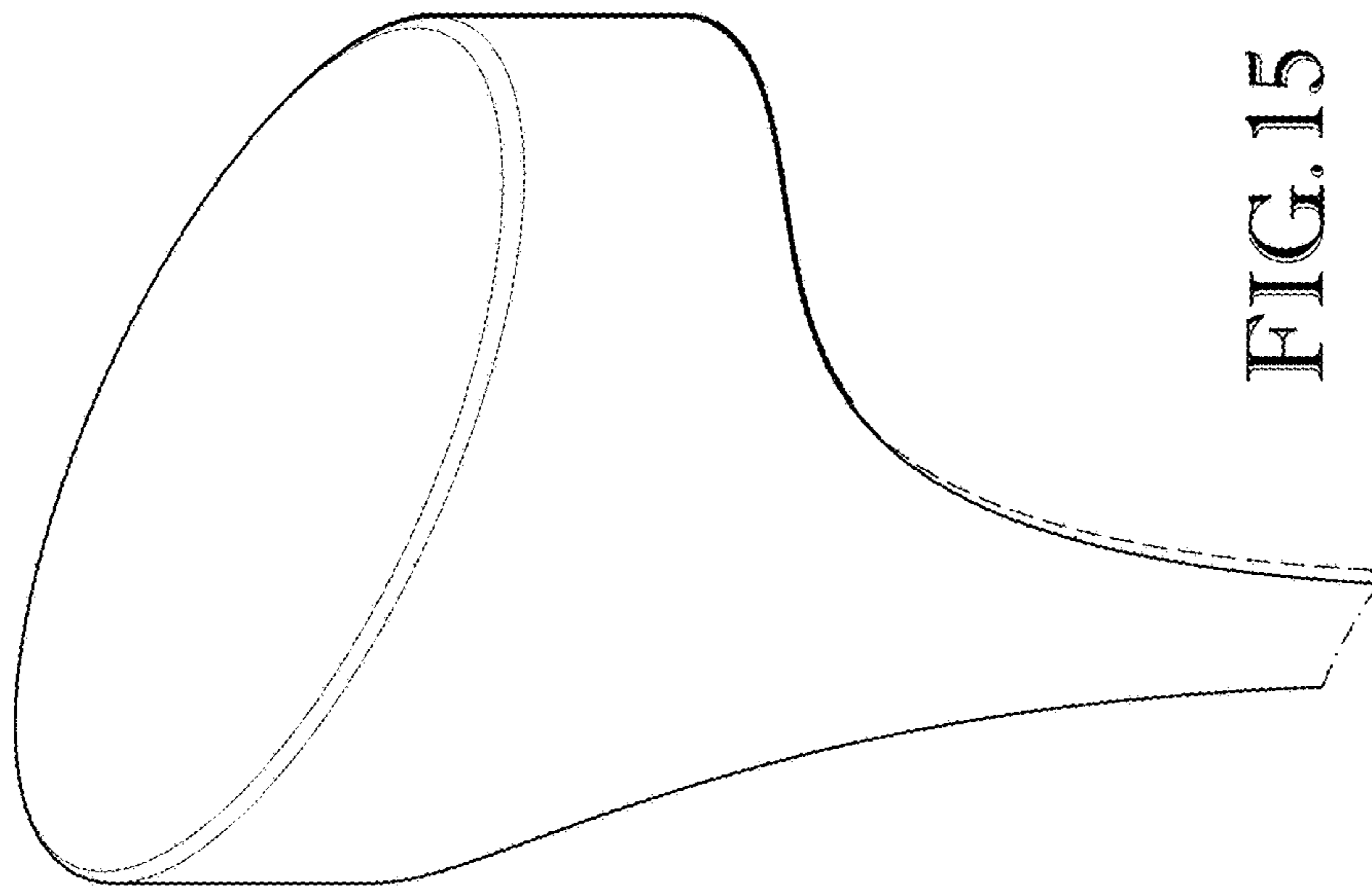

FIG. 15

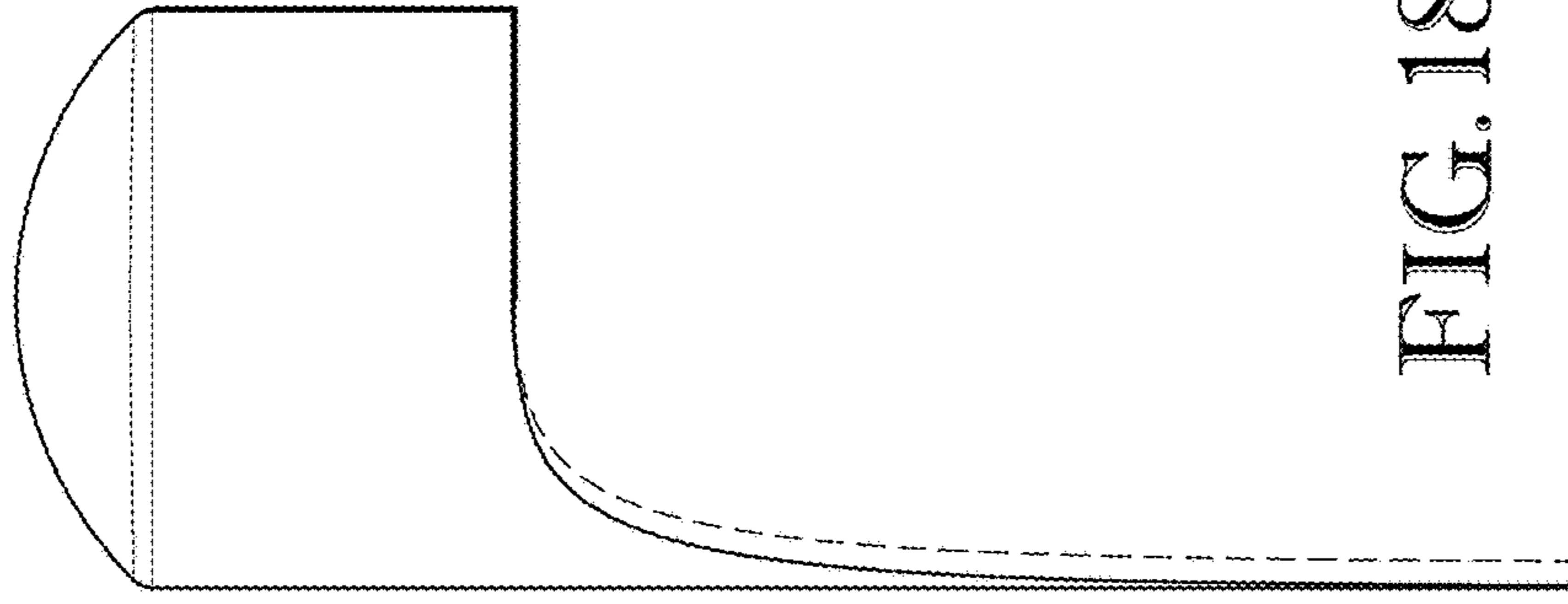

FIG. 18

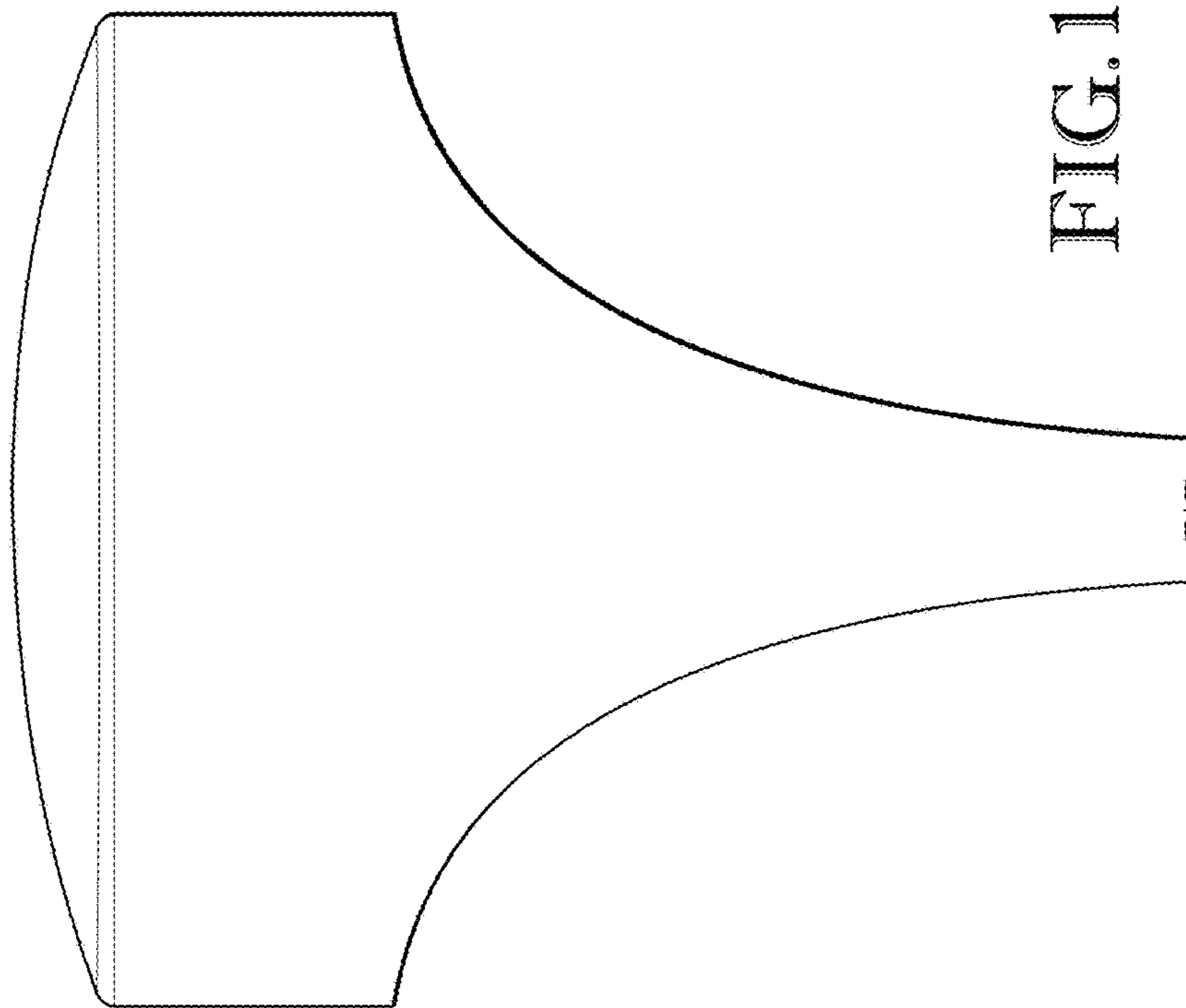

FIG. 17

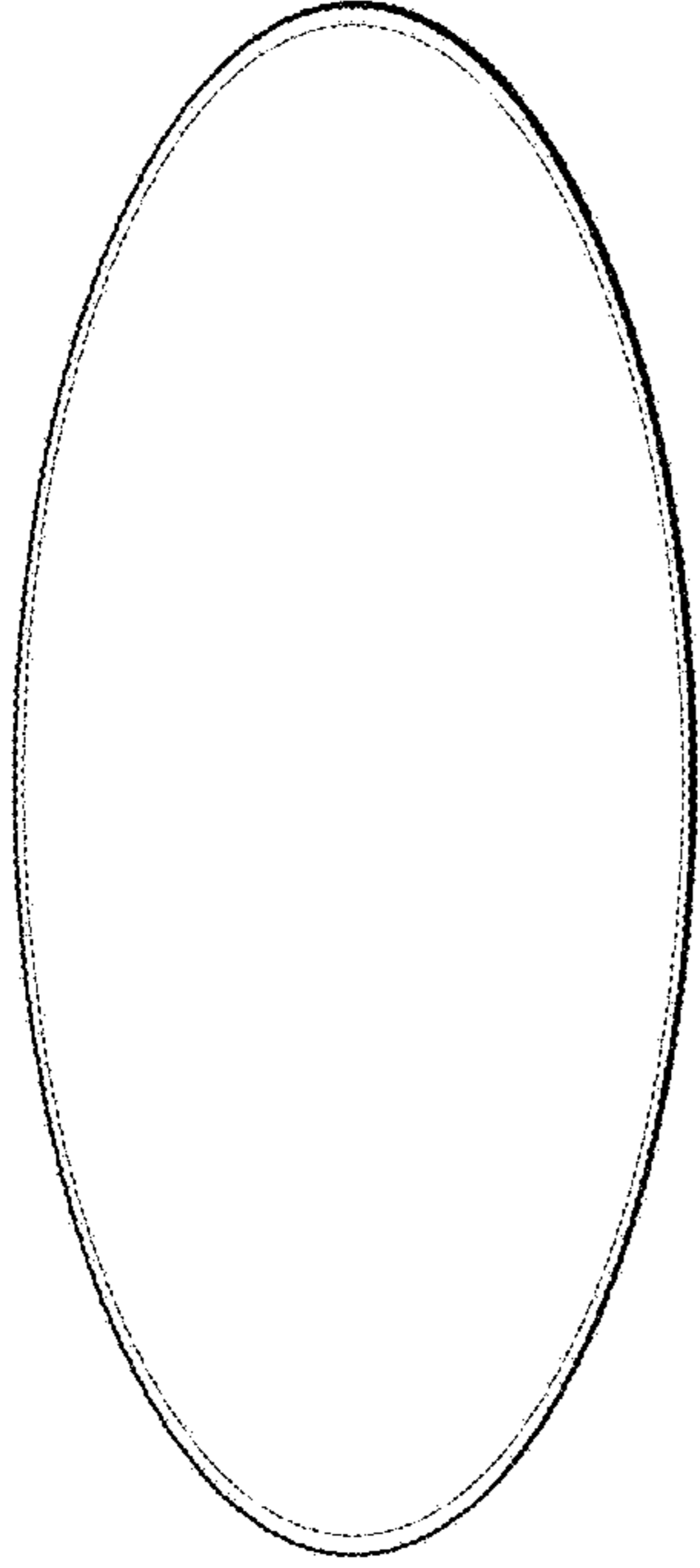

FIG. 20

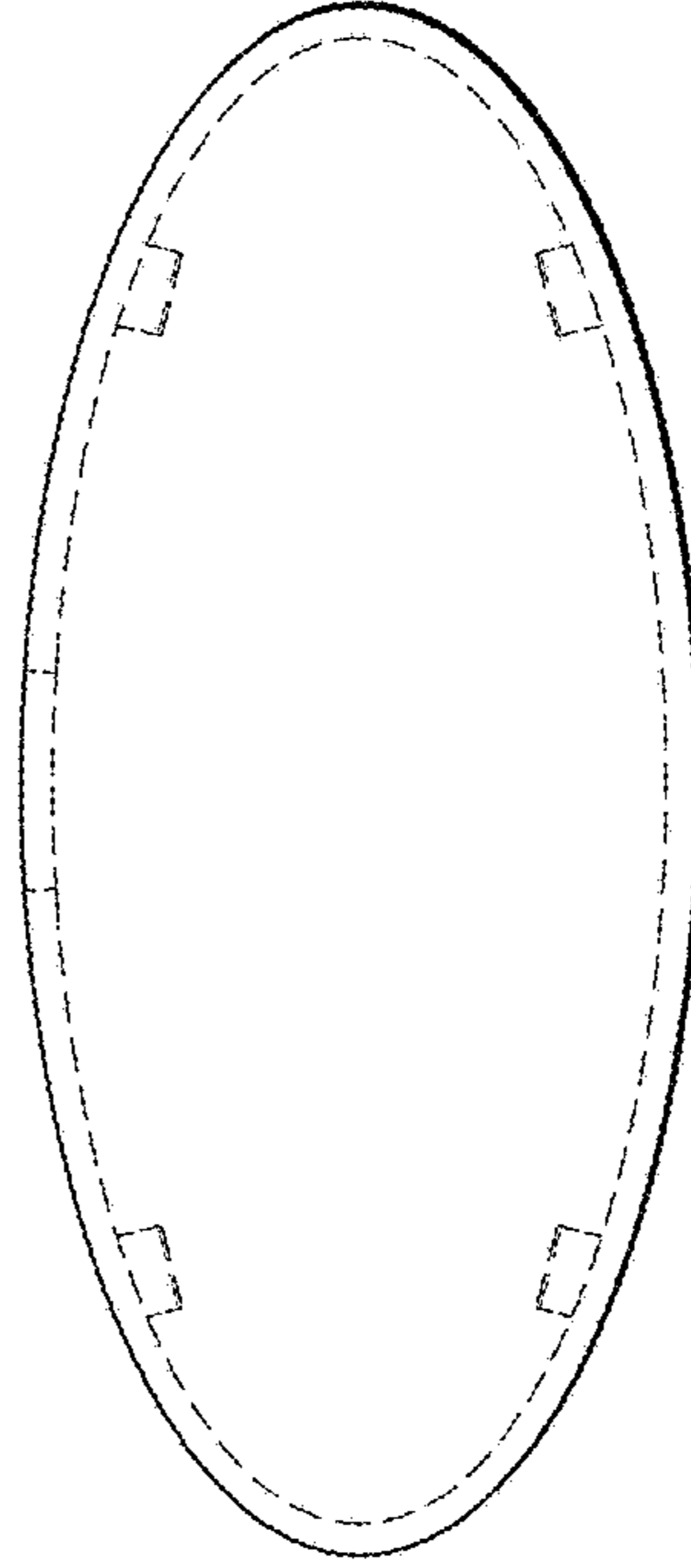

FIG. 21

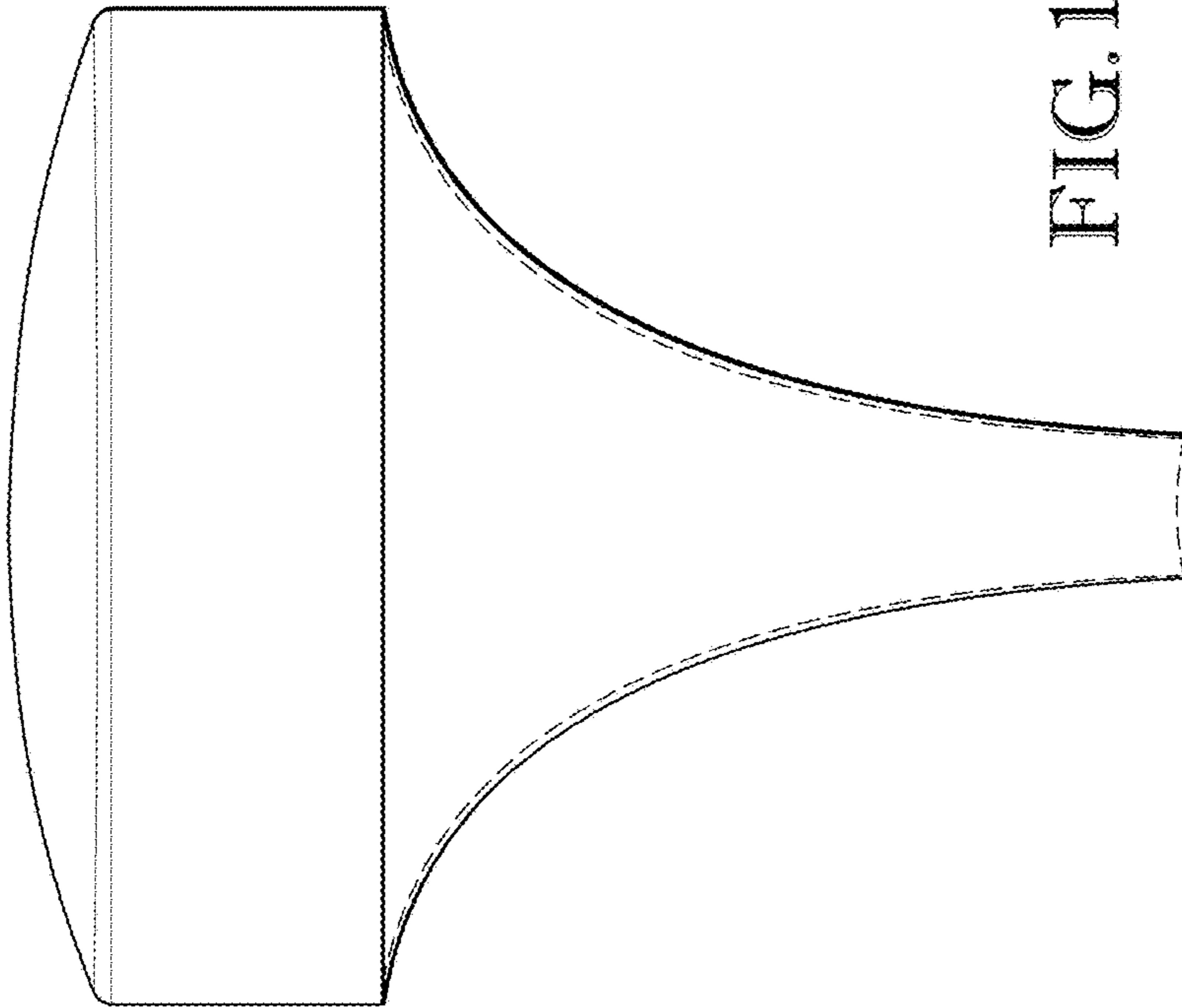

FIG. 19