



US00D817124S

(12) **United States Design Patent** (10) **Patent No.:** **US D817,124 S**  
**Gurwicz et al.** (45) **Date of Patent:** **\*\* May 8, 2018**

(54) **LIGHT BULB CHANGER HOLDER**

FOREIGN PATENT DOCUMENTS

(71) Applicant: **GR Ventures L.L.C.**, Northfield, NJ (US)

AU 2005202235 A1 12/2005  
GB 2278565 12/1994

(Continued)

(72) Inventors: **Joseph Gurwicz**, Egg Harbor Township, NJ (US); **Michael Rosen**, Boca Raton, FL (US)

OTHER PUBLICATIONS

(73) Assignee: **GR Ventures L.L.C.**, Northfield, NJ (US)

Light Bulb Change patent—Google search—<https://www.google.com/search?q=light+bulb+changer+patent&newwi...>; 12 pages; Mar. 31, 2014.

(Continued)

(\*\*) Term: **15 Years**

*Primary Examiner* — Phillip S Hyder

(21) Appl. No.: **29/555,456**

(74) *Attorney, Agent, or Firm* — Blank Rome LLP; Michael C. Greenbaum; Tara L. Marcus

(22) Filed: **Feb. 22, 2016**

(51) **LOC (11) Cl.** ..... **08-05**

(57) **CLAIM**

(52) **U.S. Cl.**  
USPC ..... **D8/14**

The ornamental design for the light bulb changer holder, as shown and described.

(58) **Field of Classification Search**  
USPC ..... D8/14  
CPC ..... H01K 3/32; H01J 9/003; B25B 23/0028; H25B 9/00  
See application file for complete search history.

**DESCRIPTION**

(56) **References Cited**

U.S. PATENT DOCUMENTS

|               |         |            |                       |
|---------------|---------|------------|-----------------------|
| 363,332 A     | 5/1887  | Hammer     |                       |
| 2,117,017 A * | 5/1938  | Chadsey    | H01K 3/32<br>81/53.11 |
| 2,157,563 A   | 5/1939  | Pethick    |                       |
| 2,634,998 A   | 4/1953  | Flower     |                       |
| 2,637,587 A * | 5/1953  | Robinson   | H01J 9/006<br>137/855 |
| 2,722,448 A   | 11/1955 | Popp       |                       |
| 2,766,060 A   | 10/1956 | Fuller     |                       |
| 4,663,996 A   | 5/1987  | Grudgfield |                       |
| D297,499 S    | 9/1988  | Whitney    |                       |
| 4,864,899 A * | 9/1989  | Morse      | H01K 3/32<br>294/86.4 |

FIG. 1 is a top perspective view of a light bulb changer holder in accordance with the present invention; FIG. 2 is a front elevational view of the light bulb changer holder illustrated in FIG. 1; FIG. 3 is a rear elevational of the light bulb changer holder illustrated in FIG. 1; FIG. 4 is a right side elevational view of the light bulb changer holder illustrated in FIG. 1; FIG. 5 is a left side elevational view of the light bulb changer holder illustrated in FIG. 1; FIG. 6 is a top plan view of the light bulb changer holder illustrated in FIG. 1; and, FIG. 7 is a bottom plan view of the light bulb changer holder illustrated in FIG. 1.

The broken lines depict portions of the light bulb changer holder in which the design is embodied that are not considered part of the claimed design.

(Continued)

**1 Claim, 7 Drawing Sheets**

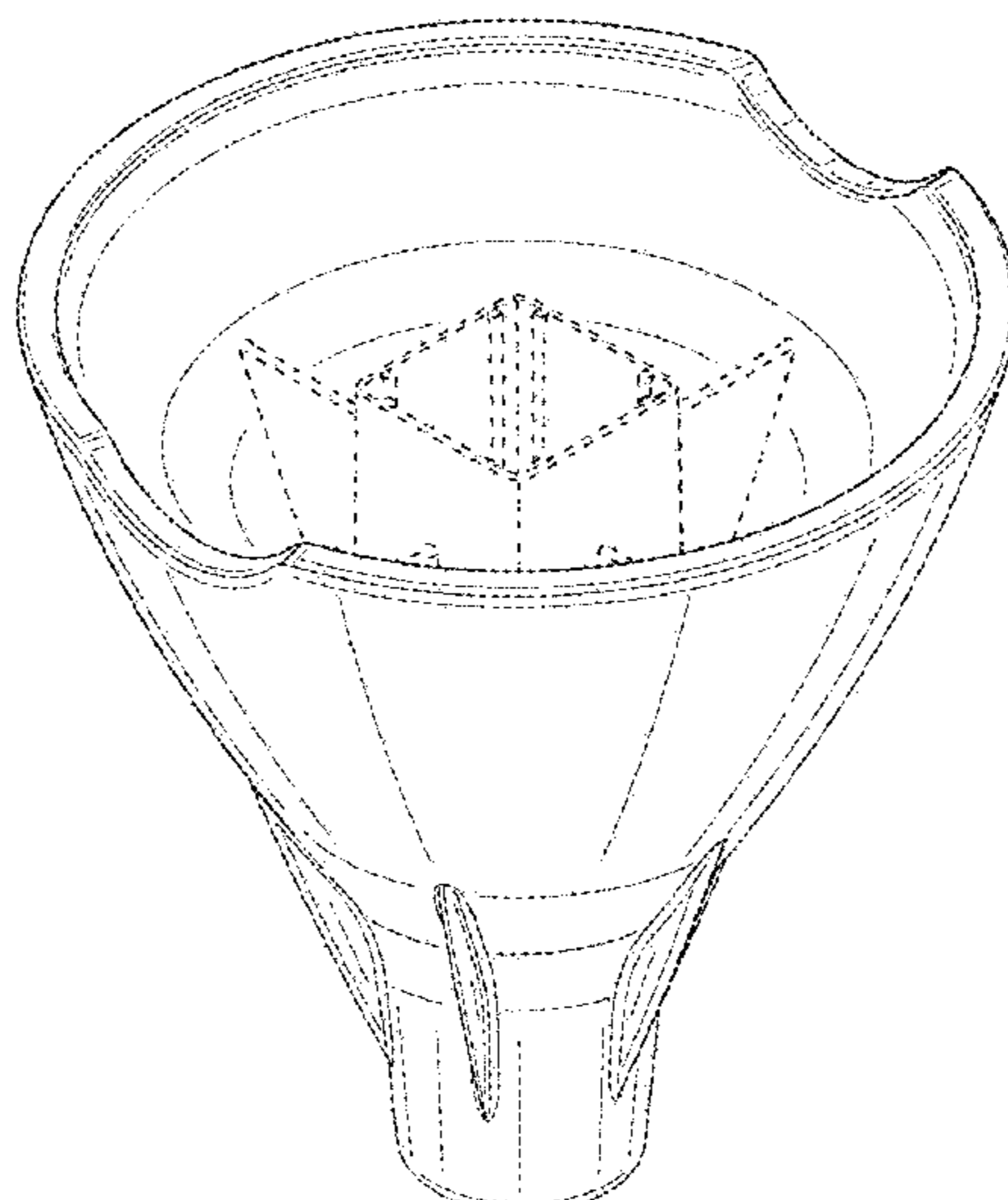

(56)

References Cited

U.S. PATENT DOCUMENTS

4,872,097 A 10/1989 Miller  
 5,148,723 A 9/1992 Newman, Sr. et al.  
 5,218,889 A 6/1993 Brockberg  
 D345,899 S 4/1994 Friend  
 5,317,939 A 6/1994 Marinescu  
 5,440,867 A \* 8/1995 Strus ..... A01D 46/253  
 56/332  
 5,809,850 A 9/1998 Tickner  
 6,223,628 B1 5/2001 Barron  
 6,257,095 B1 7/2001 Yukness  
 6,320,608 B1 11/2001 Yap et al.  
 D484,013 S \* 12/2003 Alverson, Jr. .... D8/14  
 D490,670 S 6/2004 Ball et al.  
 7,143,668 B2 12/2006 Johnson et al.  
 D544,007 S 6/2007 Marasco  
 D544,605 S 6/2007 Marasco  
 D545,333 S 6/2007 Clarke  
 7,255,024 B2 8/2007 Johnson et al.  
 7,270,031 B1 \* 9/2007 Huls ..... H01K 3/32  
 81/53.11  
 7,334,503 B1 2/2008 Newman  
 7,367,347 B2 5/2008 Field  
 7,562,605 B2 7/2009 Kunkel  
 D610,887 S 3/2010 Vivatvanit  
 8,274,241 B2 9/2012 Guest et al.  
 D672,518 S 12/2012 Facticeau et al.  
 8,476,812 B2 7/2013 Chan et al.  
 8,539,863 B2 9/2013 Gatski  
 8,546,362 B2 10/2013 Sulur et al.  
 8,555,749 B2 \* 10/2013 Gatski ..... H01K 3/32  
 81/53.11  
 8,657,351 B2 2/2014 Johnson  
 8,926,140 B2 1/2015 Wheelock  
 9,070,544 B1 6/2015 Shaps et al.  
 9,093,241 B1 \* 7/2015 Gatski ..... H01K 3/32

D745,347 S \* 12/2015 Gurwicz ..... D8/14  
 9,222,568 B2 12/2015 Schroedl  
 9,613,794 B2 4/2017 Becker  
 2002/0117870 A1 8/2002 Cash  
 2005/0178246 A1 8/2005 Johnson et al.  
 2009/0141508 A1 6/2009 Peng et al.  
 2010/0024606 A1 \* 2/2010 Becker ..... H01K 3/32  
 81/53.11  
 2010/0096992 A1 4/2010 Yamamoto et al.  
 2011/0089830 A1 4/2011 Pickard et al.  
 2012/0103141 A1 5/2012 Workman  
 2012/0182737 A1 7/2012 Kuenzler et al.  
 2013/0135888 A1 5/2013 Le Bars et al.

FOREIGN PATENT DOCUMENTS

JP 668293 U 9/1994  
 JP 08161923 A 6/1996  
 JP 2011070784 A 4/2011  
 KR 20070107429 A 11/2007  
 WO WO-8404627 A1 11/1984  
 WO WO-2005112076 A2 11/2005

OTHER PUBLICATIONS

Cleaning Supplies/Cleaning Tools/Stickyfingers Bulb Changer—  
 Pkg Q . . . ; <http://www.globalindustrial.com/p/janitorial-maintenance/cleaning-sup> . . . ; 2 pages; Mar. 31, 2014.  
 Notification Concerning Transmittal of Copy of International Preliminary Report on Patentability, PCT/US2015/027935, Nov. 10, 2016.  
 Supplementary European Search Report, EP 15 78 5311, dated Jan. 9, 2017.  
 International Search Report and Written Opinion issued in PCT/US2017/018293 dated May 16, 2017.

\* cited by examiner

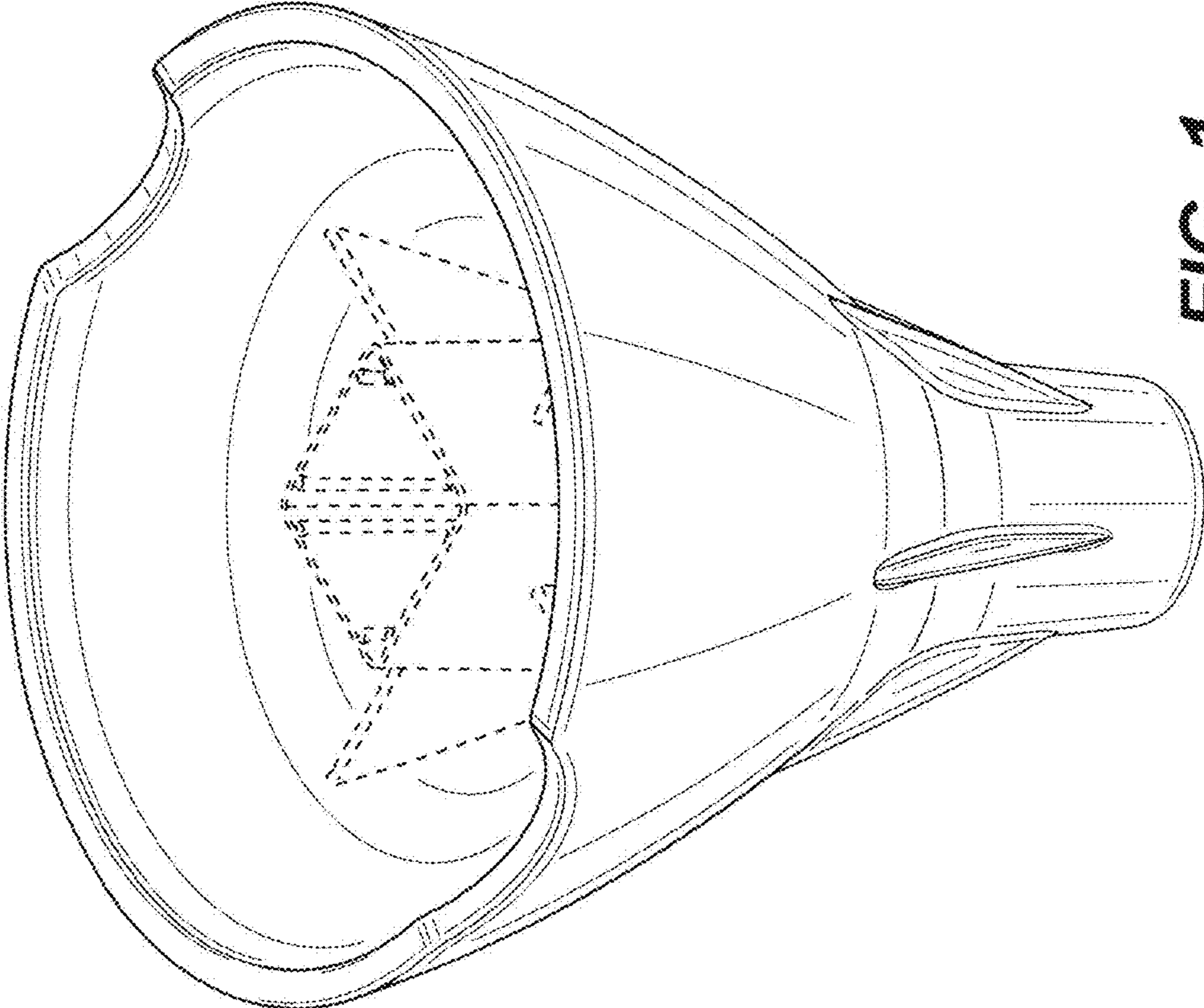

FIG. 1

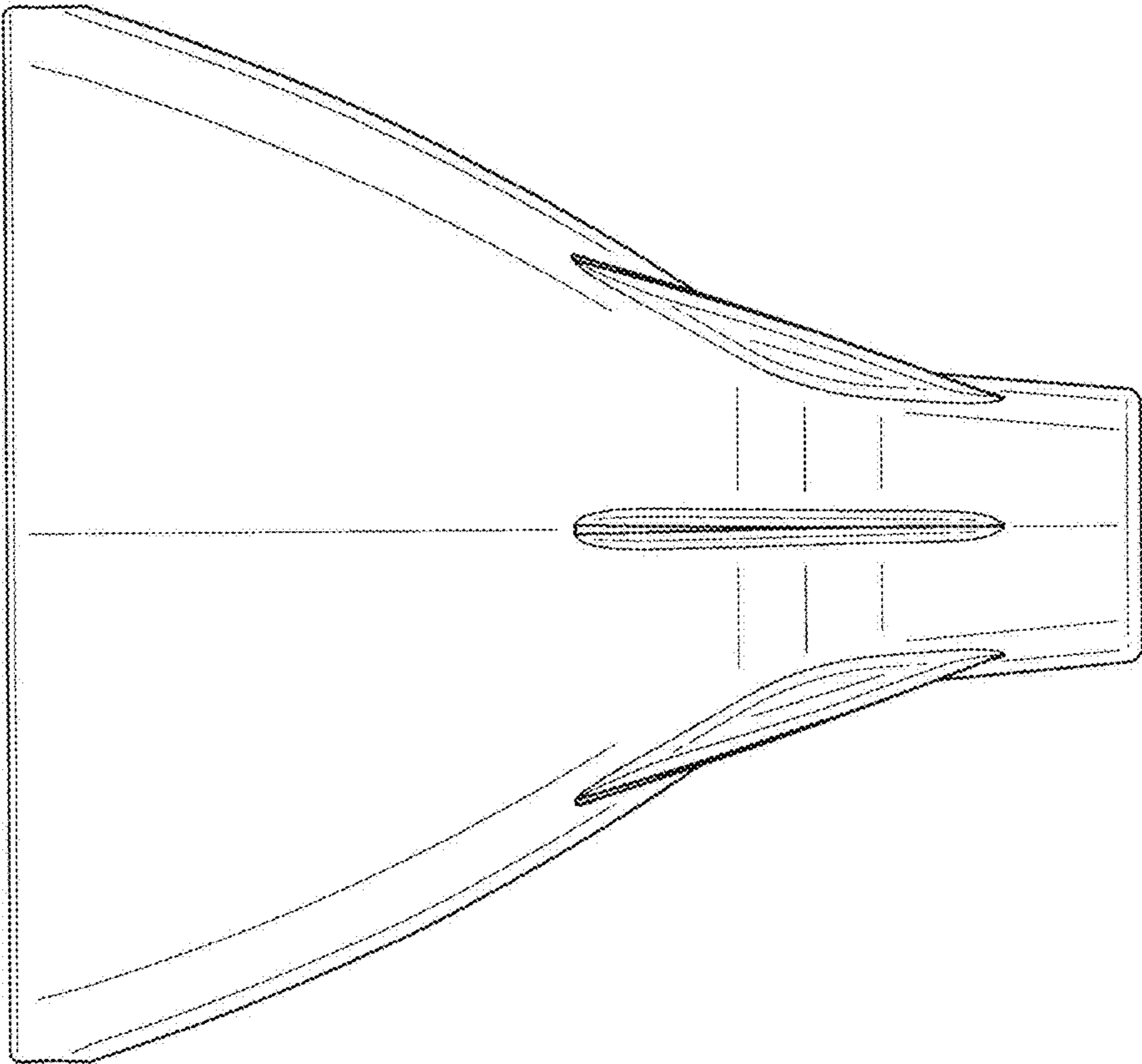

FIG. 2



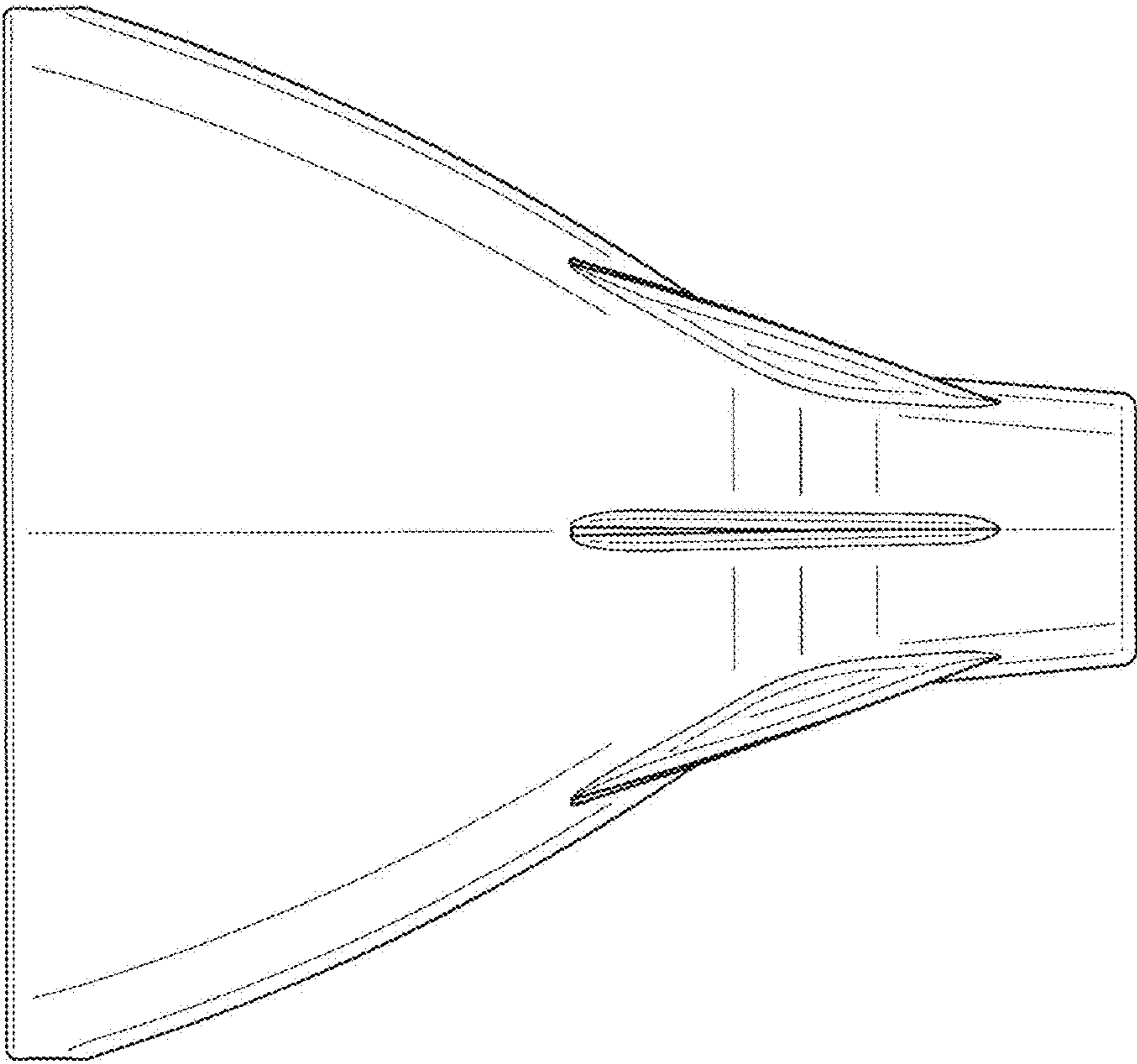
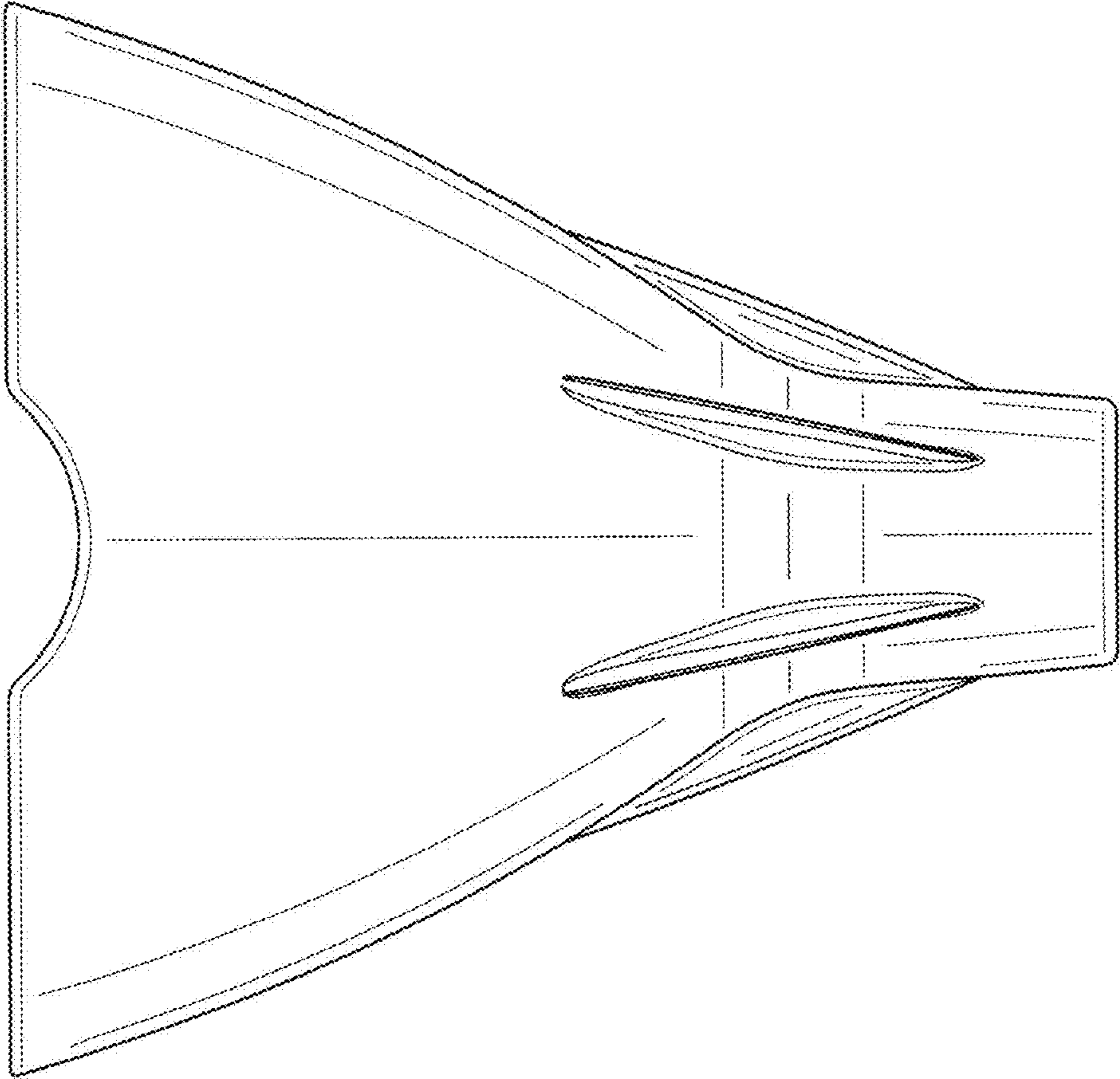

FIG. 3



**FIG. 4**

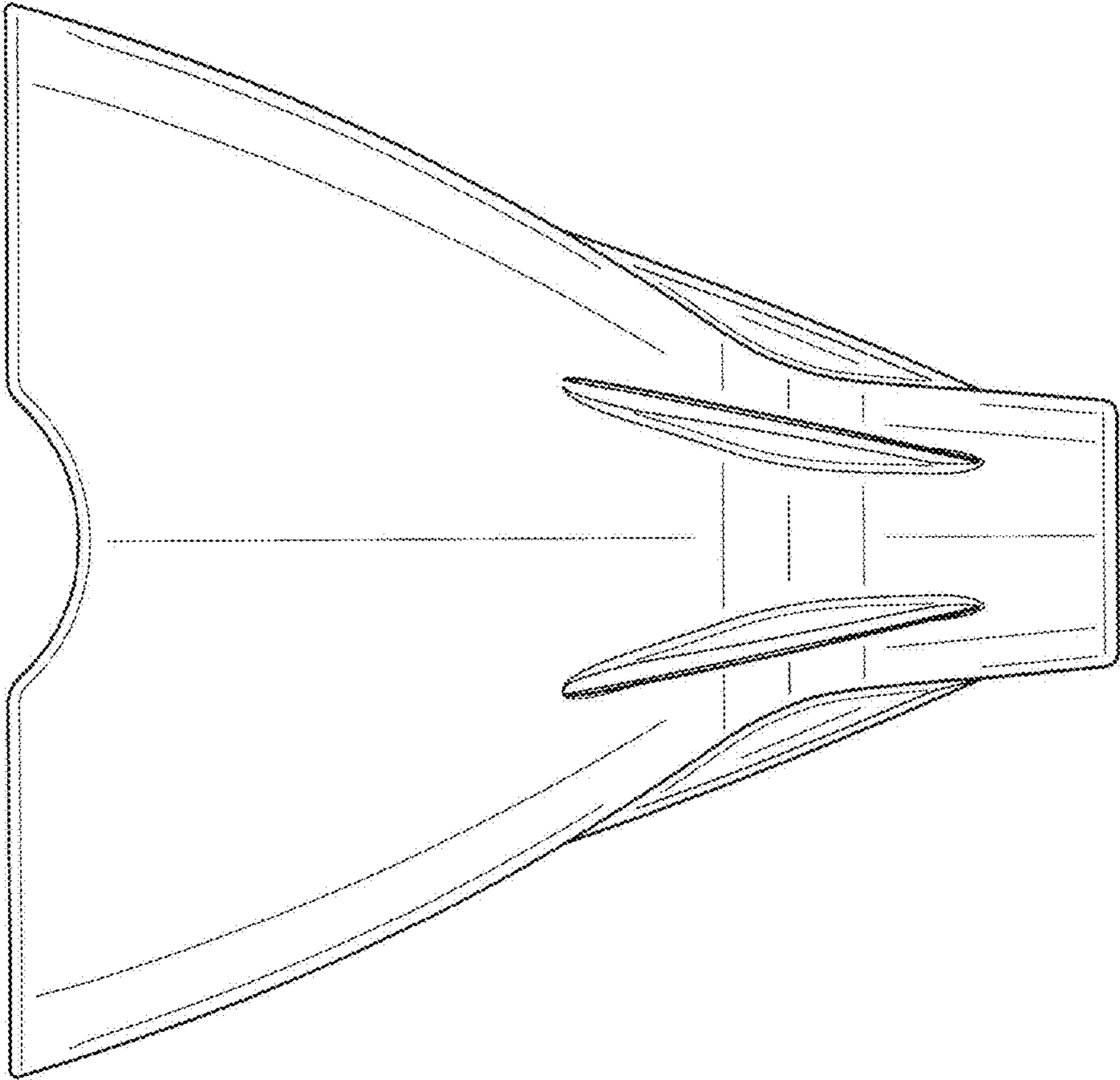
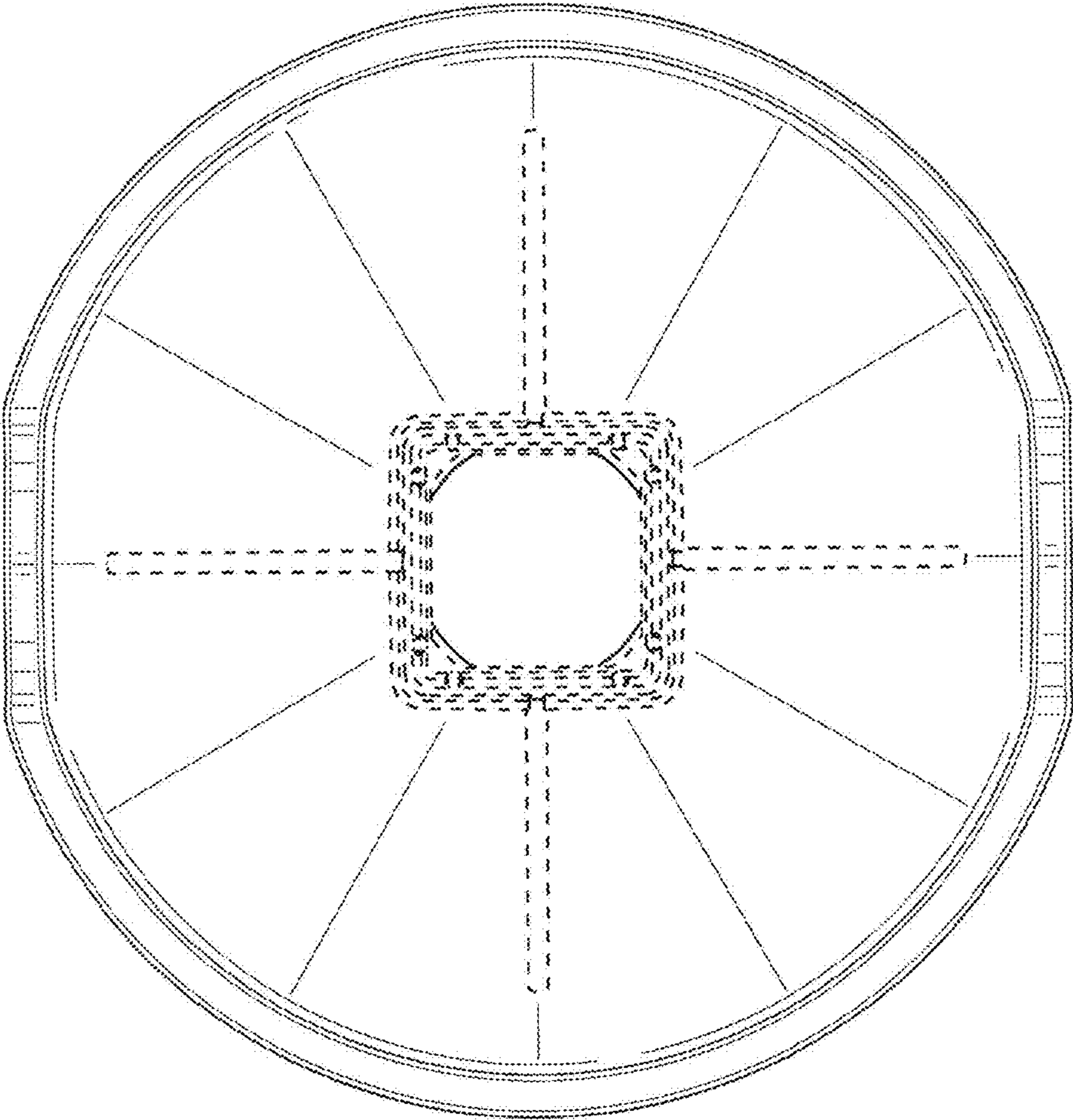

FIG. 5



**FIG. 6**



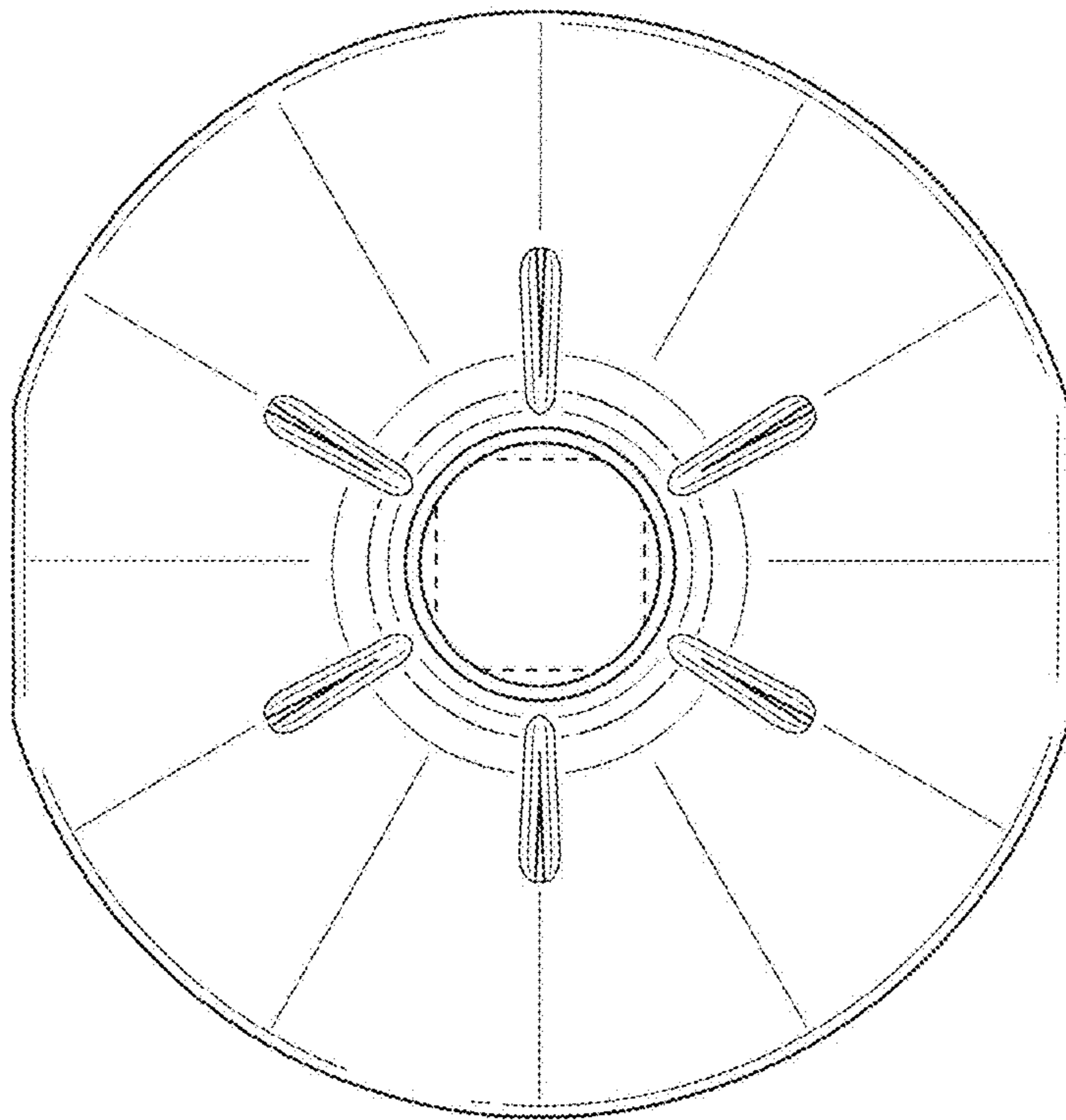

FIG. 7