



US00D817100S

(12) **United States Design Patent**  
**Xu et al.**

(10) **Patent No.:** **US D817,100 S**

(45) **Date of Patent:** **\*\* May 8, 2018**

(54) **CUP**

(71) Applicant: **SHENZHEN ROYOLE TECHNOLOGIES CO. LTD.**,  
Shenzhen (CN)

(72) Inventors: **Rui Xu**, Shenzhen (CN); **Xinyuan Xia**,  
Shenzhen (CN); **Chao Jiang**, Shenzhen  
(CN)

(73) Assignee: **SHENZHEN ROYOLE TECHNOLOGIES CO. LTD.**,  
Shenzhen (CN)

(\*\*) Term: **15 Years**

(21) Appl. No.: **29/568,166**

(22) Filed: **Jun. 15, 2016**

(30) **Foreign Application Priority Data**

Dec. 16, 2015 (CN) ..... 2015 3 0536438

(51) **LOC (11) Cl.** ..... **07-01**

(52) **U.S. Cl.**  
USPC ..... **D7/532; D7/509**

(58) **Field of Classification Search**  
USPC ..... D7/507, 509, 510, 511, 523, 529, 530,  
D7/608, 536, 532; D9/500, 502, 503,  
D9/504, 517, 530, 538, 539, 540, 541,  
D9/544, 545, 547, 548, 552, 569, 453,  
D9/452; 220/592.16, 592.17; 215/381,  
215/382

CPC ..... A47G 19/22; A47G 19/2205; A47G  
19/2211; A47G 19/2266; A47G 19/2272;  
A45F 3/16; B65D 41/04

See application file for complete search history.

(56) **References Cited**

**U.S. PATENT DOCUMENTS**

D31,230 S \* 7/1899 Hogan ..... D7/509  
D271,050 S \* 10/1983 Berkman ..... D28/77

D289,722 S \* 5/1987 Neiser ..... D7/603  
D299,688 S \* 2/1989 Chung ..... D7/536  
D305,193 S \* 12/1989 Sajadieh ..... D7/509  
D324,332 S \* 3/1992 Seifert ..... D9/520  
D330,512 S \* 10/1992 Ryberg ..... D9/414  
D360,583 S \* 7/1995 Paping ..... D9/414  
D365,499 S \* 12/1995 Welker ..... D7/509  
D441,160 S \* 4/2001 Lin ..... D34/7  
D451,027 S \* 11/2001 Dugrot ..... D9/500  
D462,997 S \* 9/2002 Slater ..... D19/77  
D538,483 S \* 3/2007 Bakic ..... D28/89  
D540,620 S \* 4/2007 Bushkovsky ..... D7/509  
D543,790 S \* 6/2007 Szymanski ..... D7/607  
D549,313 S \* 8/2007 Kelnhofer ..... D23/360  
D611,301 S \* 3/2010 Amano ..... D7/509  
D621,223 S \* 8/2010 Bas ..... D7/603  
D649,021 S \* 11/2011 Jariwala ..... D8/367  
D662,785 S \* 7/2012 Kern ..... D32/55  
D691,889 S \* 10/2013 Mettler ..... D9/454  
D697,510 S \* 1/2014 Sato ..... D14/420

(Continued)

*Primary Examiner* — Marianne Pandozzi

*Assistant Examiner* — Jae Liang

(74) *Attorney, Agent, or Firm* — Hauptman Ham, LLP

(57) **CLAIM**

The ornamental design for a cup, as shown and described.

**DESCRIPTION**

FIG. 1 is a front view of a cup showing my new design;  
FIG. 2 is a rear view thereof;  
FIG. 3 is a left side view thereof;  
FIG. 4 is a right side view thereof;  
FIG. 5 is a top view thereof;  
FIG. 6 is a bottom view thereof; and,  
FIG. 7 is a perspective view thereof.  
The broken lines in the drawings depict portions of the cup  
that form no part of the claimed design.

**1 Claim, 7 Drawing Sheets**

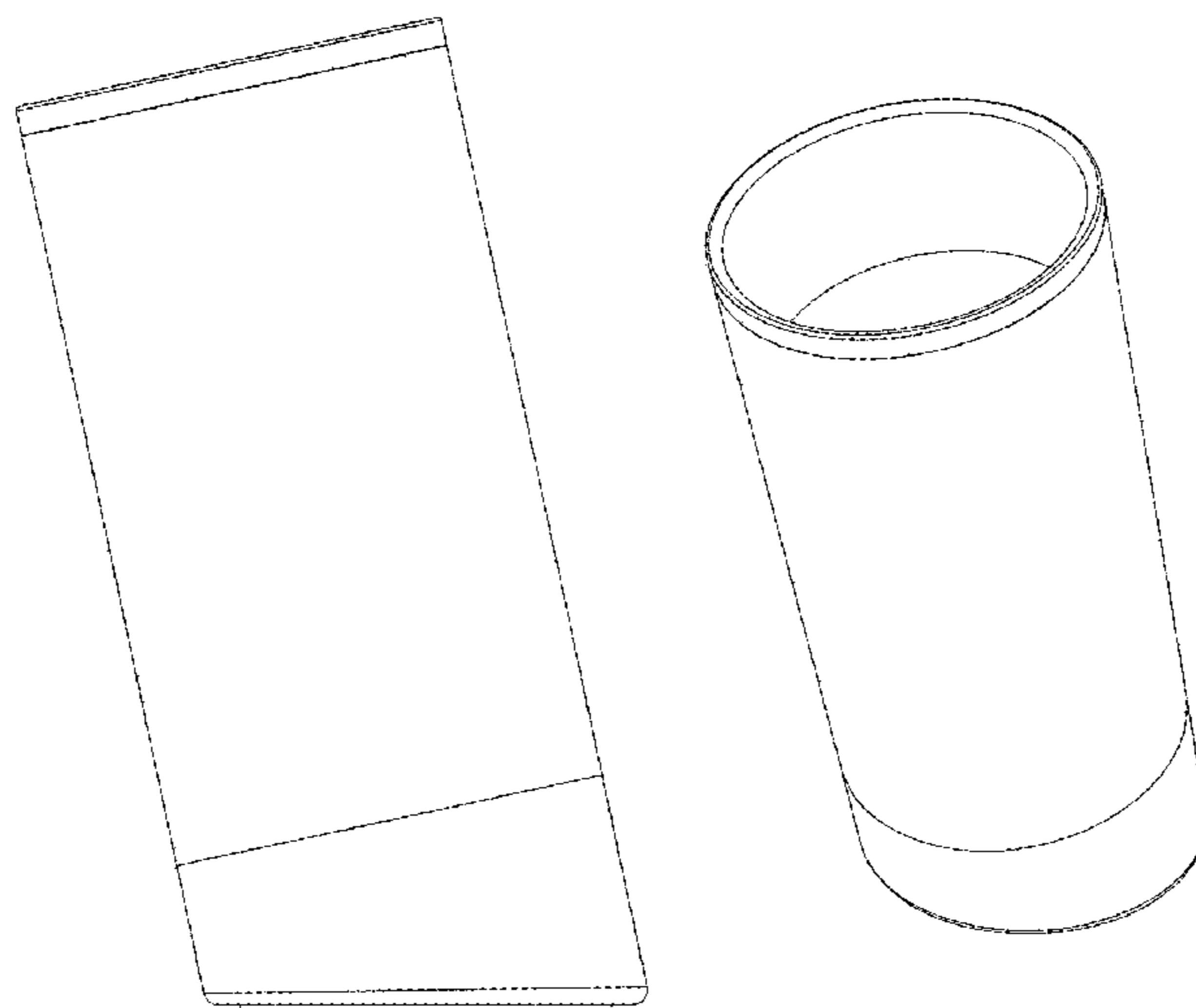

(56)

**References Cited**

U.S. PATENT DOCUMENTS

|                   |        |                     |                         |
|-------------------|--------|---------------------|-------------------------|
| D728,371 S *      | 5/2015 | Behar .....         | D9/454                  |
| D753,445 S *      | 4/2016 | Khalifa .....       | D7/615                  |
| D761,057 S *      | 7/2016 | McClendon, Jr. .... | D7/300.2                |
| D779,124 S *      | 2/2017 | Houyoux .....       | D28/91.1                |
| D786,088 S *      | 5/2017 | Wilson .....        | D9/688                  |
| 2014/0284343 A1 * | 9/2014 | Allen .....         | A47G 19/2222<br>220/710 |

\* cited by examiner

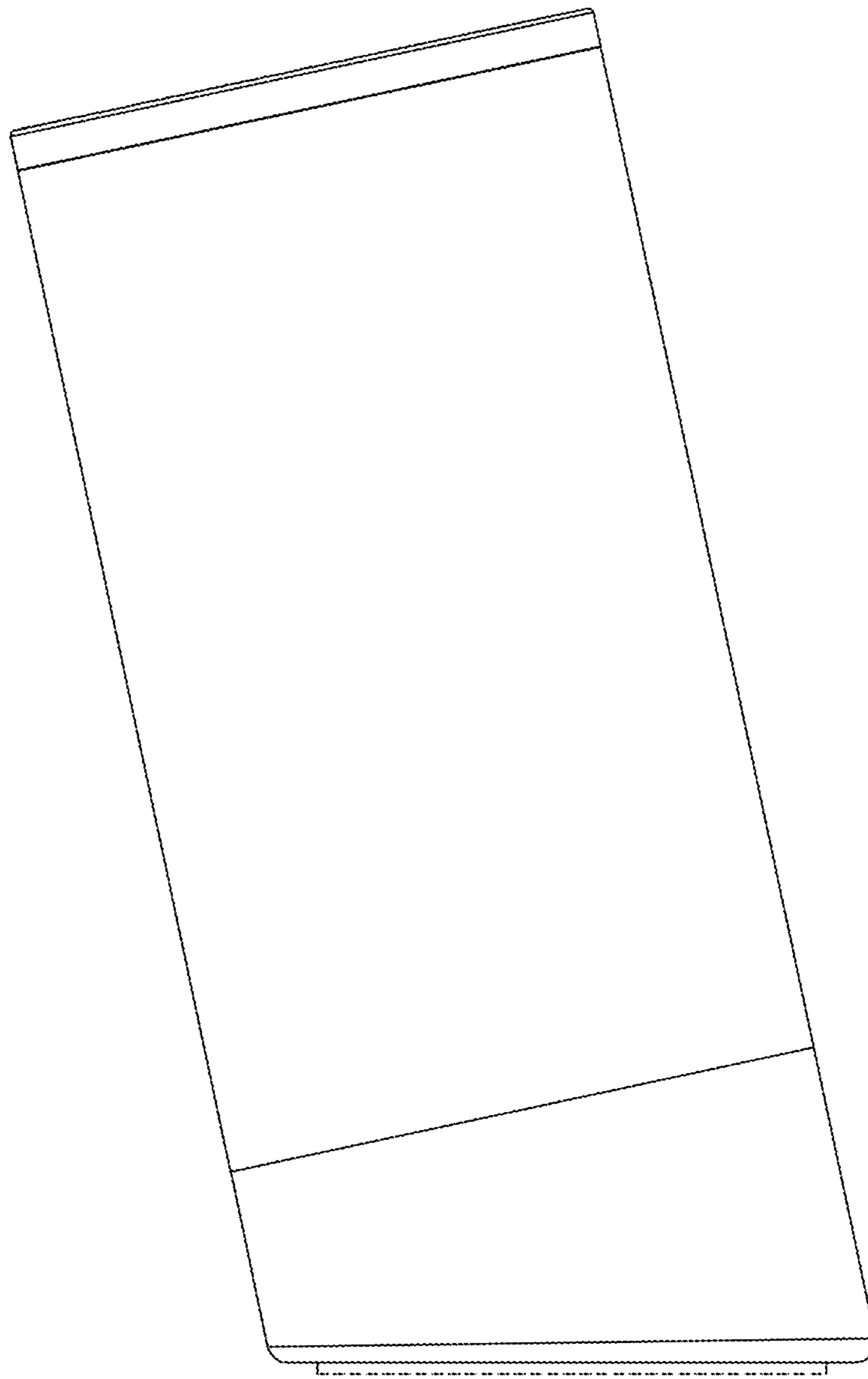

FIG.1

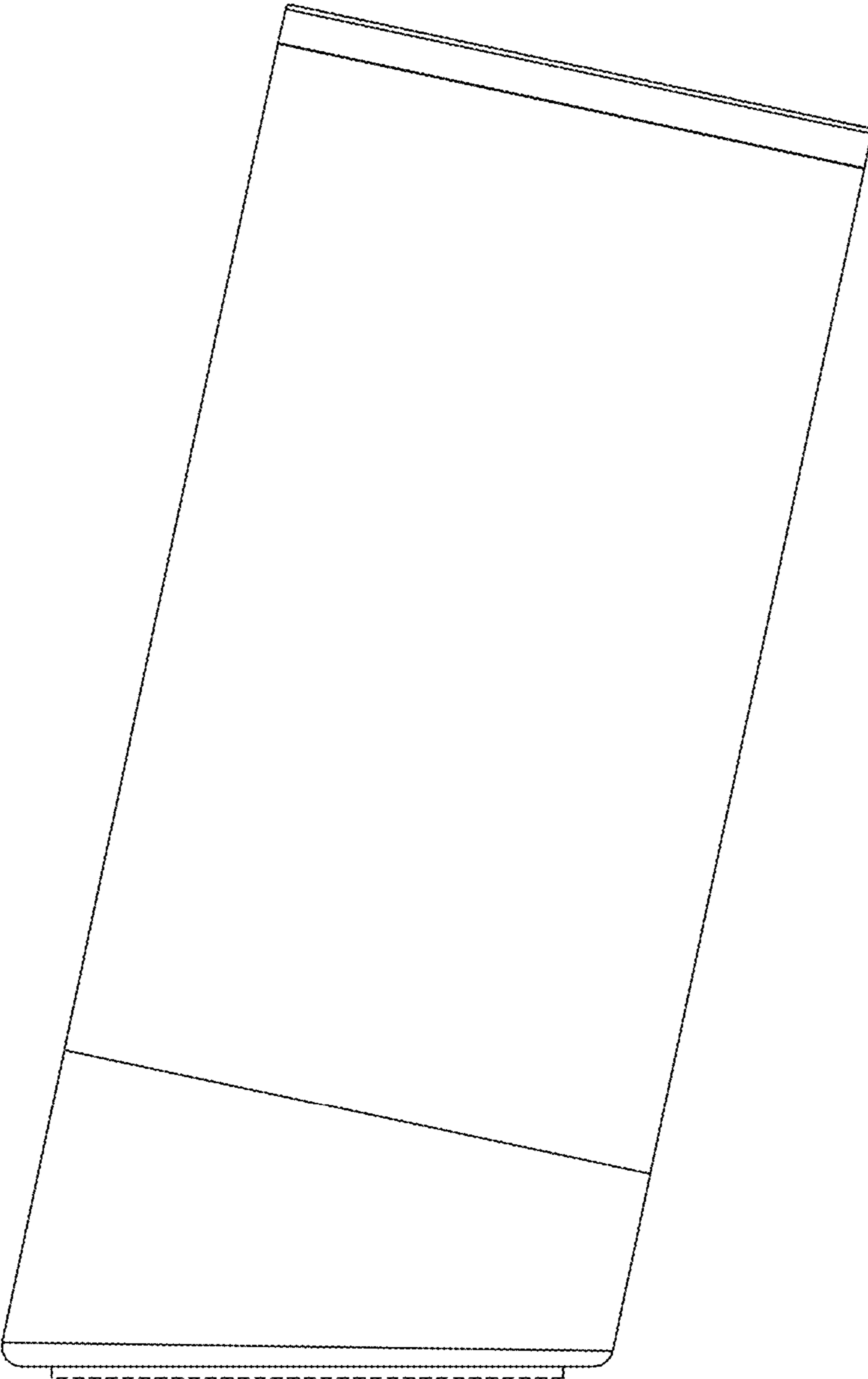

FIG.2

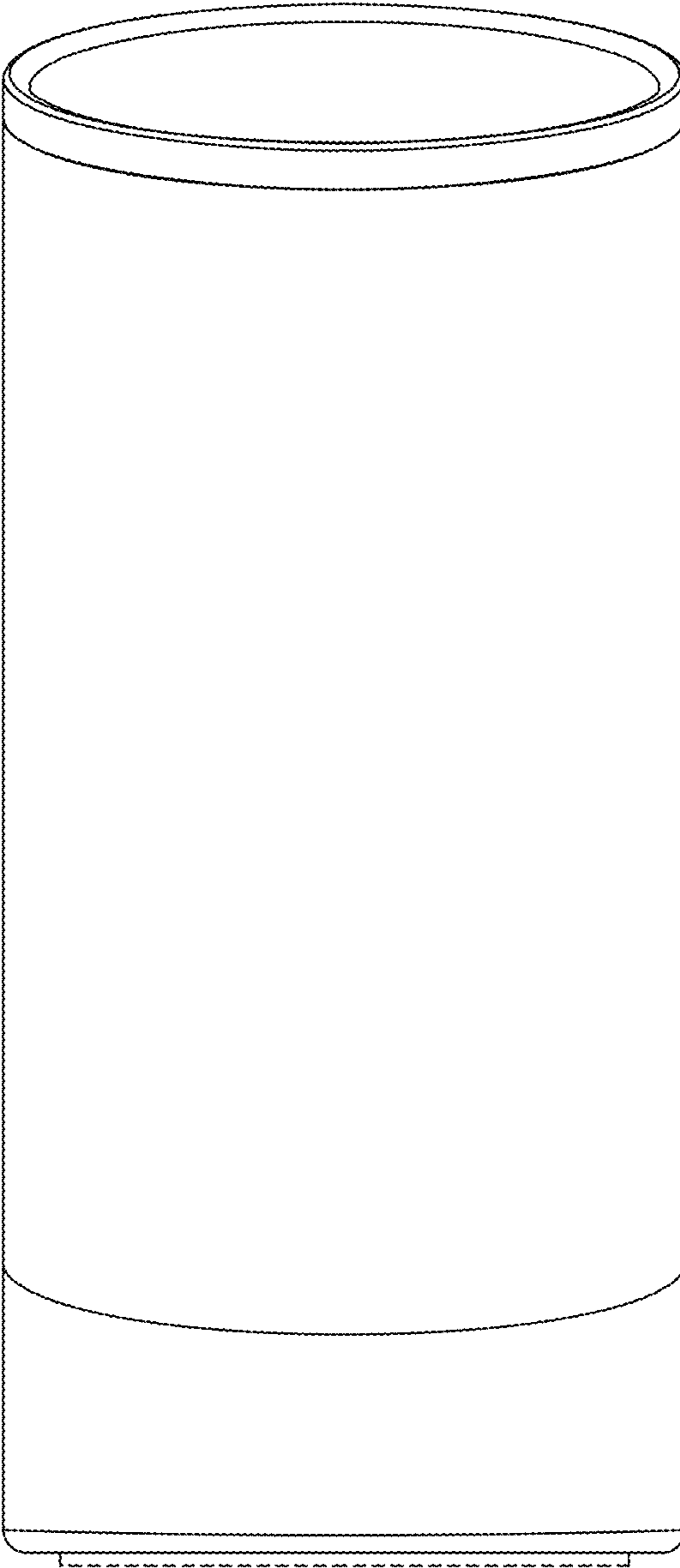

FIG.3



FIG. 4

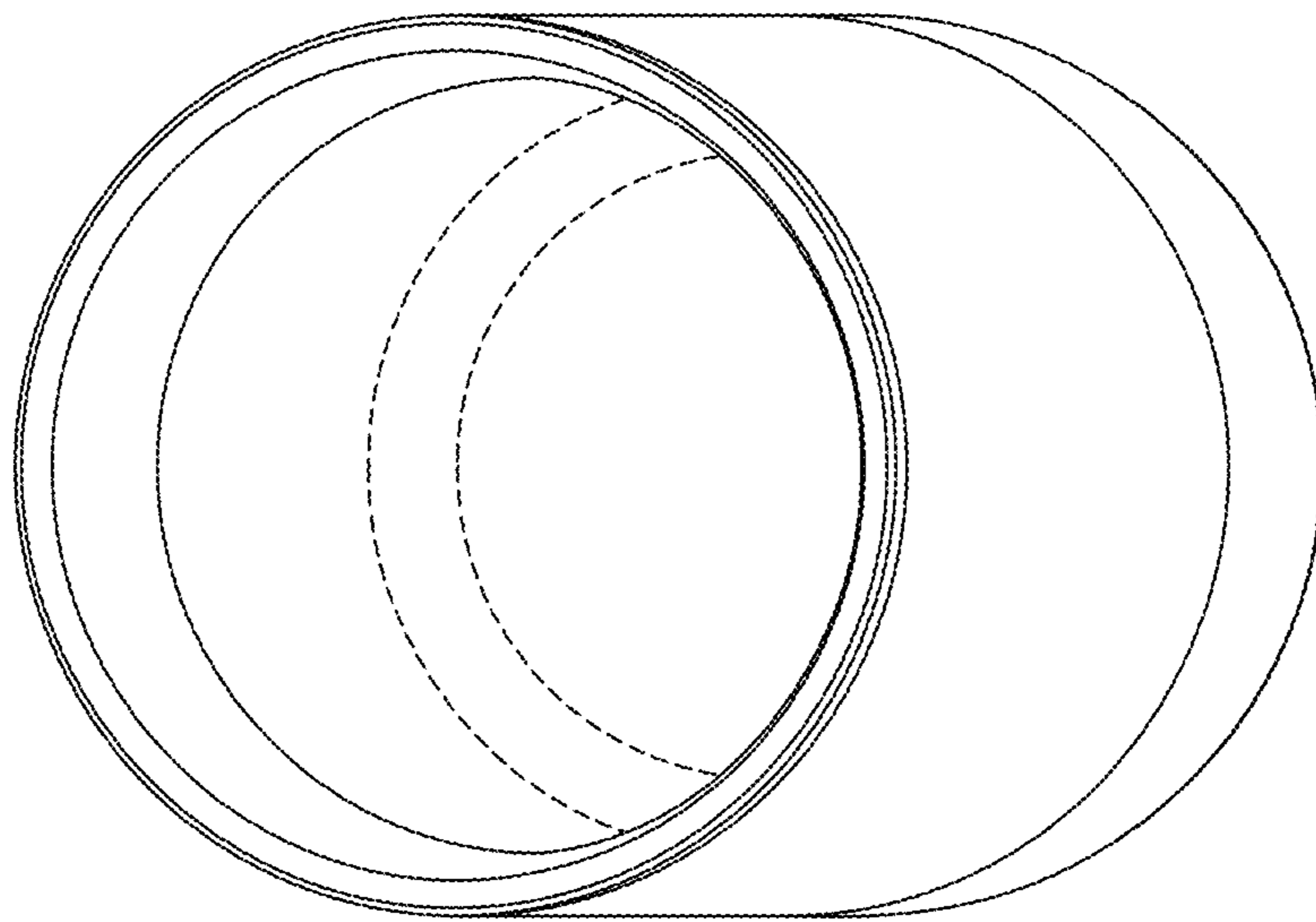

FIG. 5

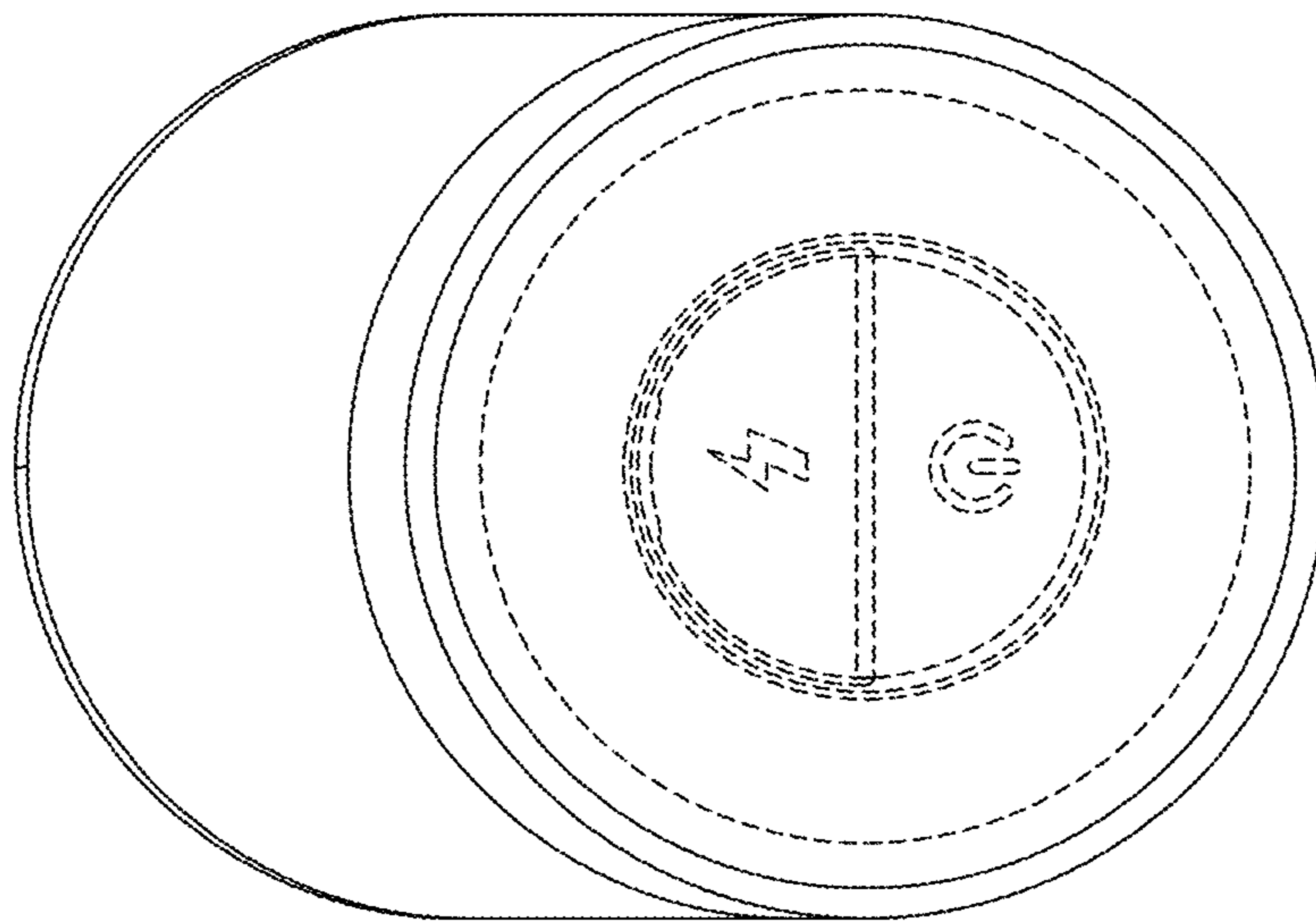

FIG.6



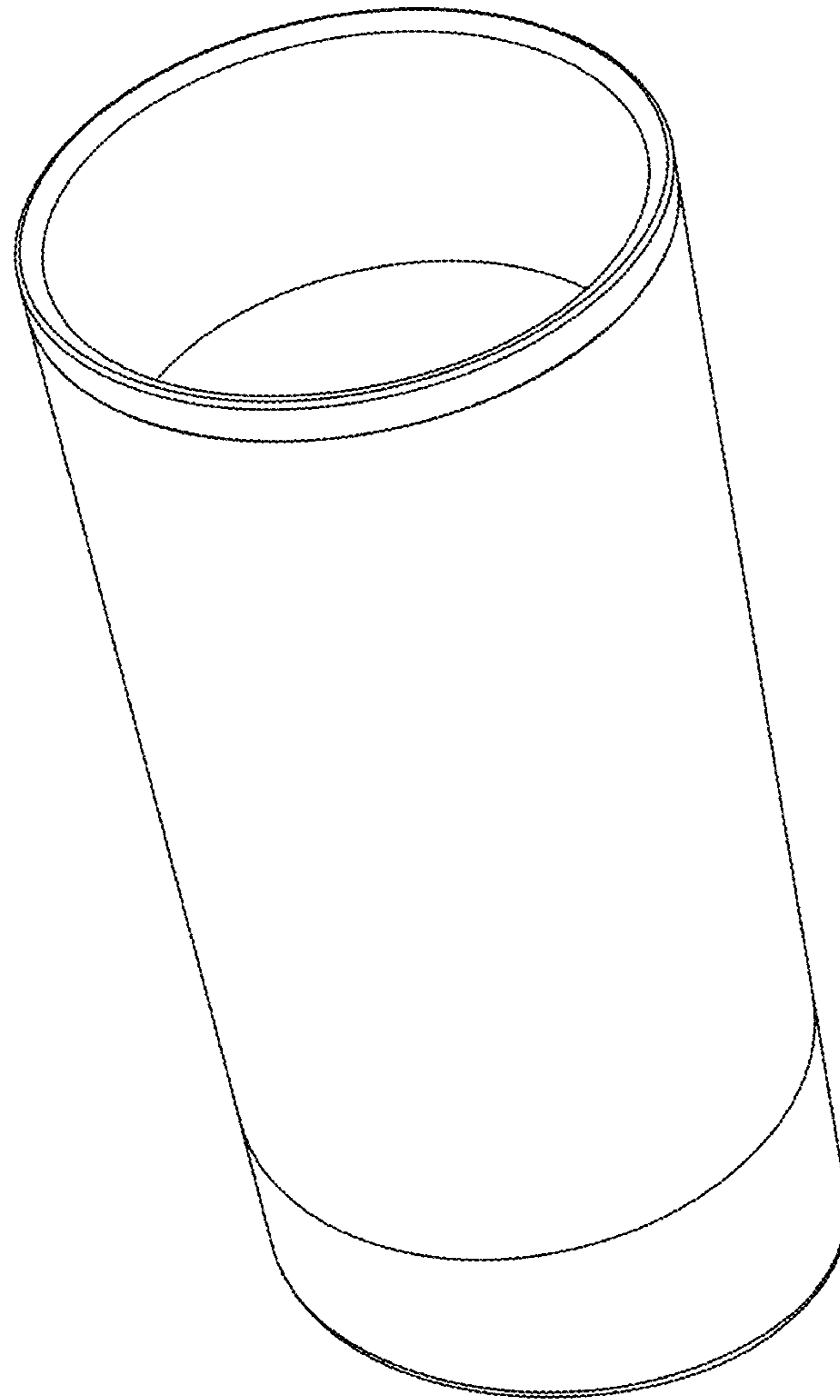

FIG.7