



US00D817095S

(12) **United States Design Patent**
Kauss et al.

(10) **Patent No.:** **US D817,095 S**

(45) **Date of Patent:** **** May 8, 2018**

(54) **BOTTLE WITH CAP**

(71) Applicant: **Can't Live Without It, LLC**, New York, NY (US)

(72) Inventors: **Sarah Kauss**, New York, NY (US);
Clay Allen Burns, New York, NY (US);
James Best, Hewitt, NJ (US);
Kim Dunphy, Brooklyn, NY (US);
Courtney Deary, Brooklyn, NY (US);
Sarah Williams, Brooklyn, NY (US)

(73) Assignee: **CAN'T LIVE WITHOUT IT, LLC**, New York, NY (US)

(**) Term: **15 Years**

(21) Appl. No.: **29/621,884**

(22) Filed: **Oct. 12, 2017**

Related U.S. Application Data

(62) Division of application No. 29/592,744, filed on Feb. 1, 2017.

(51) **LOC (11) Cl.** **07-01**

(52) **U.S. Cl.**
USPC **D7/511**; D9/453; D9/454; D9/538;
D9/539; D9/558

(58) **Field of Classification Search**

USPC D9/434-435, 443, 446-447, 449,
D9/453-454, 500, 503-504, 516, 530,
D9/537-539, 549, 557-558, 715, 719;
D7/391-392, 507, 509-511, 523, 608
CPC B65D 1/00; B65D 1/02; B65D 1/0223;
B65D 23/00; B65D 81/00; B65D
2501/00; B65D 2501/0009; A45F 3/16;
A45F

(Continued)

(56) **References Cited**

U.S. PATENT DOCUMENTS

D12,943 S 5/1882 Sanborn
2,691,548 A 10/1954 Otto et al.

(Continued)

OTHER PUBLICATIONS

AquaFlask; <http://www.theaquaflask.com/shop-2/aquaflask-insulated-double-wall-stainless-steel-water-bottle-with-handle-27-ounce-glossy-stainless-steel>; page accessed on Sep. 7, 2016.

(Continued)

Primary Examiner — Dana L Meyrow

(74) *Attorney, Agent, or Firm* — Kilpatrick Townsend & Stockton LLP

(57) **CLAIM**

An ornamental design for a bottle with cap, as shown and described.

DESCRIPTION

FIG. 1 is a front perspective view of a first embodiment of a bottle with cap;
FIG. 2 is a front elevational view thereof;
FIG. 3 is a rear elevational view thereof;
FIG. 4 is a right-side elevational view thereof;
FIG. 5 is a left-side elevational view thereof;
FIG. 6 is a top view thereof;
FIG. 7 is a bottom view thereof;
FIG. 8 is a bottom-rear perspective view thereof;
FIG. 9 is a front perspective view of a second embodiment of a bottle with cap;
FIG. 10 is a front elevational view thereof;
FIG. 11 is a rear elevational view thereof;
FIG. 12 is a right-side elevational view thereof;
FIG. 13 is a left-side elevational view thereof;
FIG. 14 is a top view thereof;
FIG. 15 is a bottom view thereof; and,
FIG. 16 is a bottom-rear perspective view thereof.
The dot-dash broken lines in the drawings define the bounds of the claim. Those boundary lines and the unshaded area within form no part of the claimed design.

1 Claim, 10 Drawing Sheets



US D817,095 S

Page 2

(58) **Field of Classification Search**

CPC 2003/163; A47G 19/22; A47G 19/2205;
A47G 19/2288

See application file for complete search history.

(56) **References Cited**

U.S. PATENT DOCUMENTS

2,987,212	A	6/1961	Scanlon	
2,991,896	A *	7/1961	Glover	B65D 23/0814 215/12.2
D219,125	S	11/1970	Gorts et al.	
4,124,148	A	11/1978	Vieler et al.	
D322,936	S *	1/1992	Maginnis, Jr.	D9/538
D392,565	S	3/1998	Blackburn	
D409,051	S	5/1999	Huang	
D481,949	S	11/2003	Pinnavaia	
D483,264	S	12/2003	Canepa	
D500,444	S	1/2005	Drake et al.	
D582,278	S	12/2008	Bourne	
D596,942	S	7/2009	Britto	
D609,536	S	2/2010	Tang	
D620,742	S	8/2010	Lion et al.	
D663,618	S	7/2012	Cohen et al.	
D671,409	S	11/2012	Cohen et al.	
D693,688	S *	11/2013	Russell	D9/454
D702,131	S	4/2014	Handy	
D711,180	S	8/2014	Villa	

D726,018	S *	4/2015	Archer	D9/446
D733,282	S *	6/2015	Peterson	D23/328
D745,398	S	12/2015	Cotton	
D760,590	S	7/2016	Renner et al.	
D762,476	S	8/2016	Velmer et al.	
D772,070	S	11/2016	Broen et al.	
D787,939	S	5/2017	Lam	
D804,254	S	12/2017	Seiders et al.	

OTHER PUBLICATIONS

Eco promotions online; personalized stainless steel water bottles; page accessed on Sep. 7, 2016.

Caribou Coffee; Ombre double walled stainless steel water bottle; <https://web.archive.org/web/20100923223026/https://cariboucoffee.com/asp/shop/det/ail.asp?c=4&p=777>; published Sep. 23, 2010. GoodlifeBottles; www.goodlifebottles.com; page accessed on Feb. 2, 2017.

DIV Trade; Double-wall stainless steel sports bottle; Yongkang Merle Industry & Trade Co., Ltd.; http://www.diytrade.com/china/pd/7276391/double_wall_Stainless_Steel_Sports_Bottle.html; published Dec. 2010.

Bottle "A" identified prior to Nov. 18, 2016.

Bottle "B" identified prior to Nov. 18, 2016.

U.S. Appl. No. 29/625,984, "Notice of Allowance", dated Jan. 30, 2018, 15 pages.

* cited by examiner

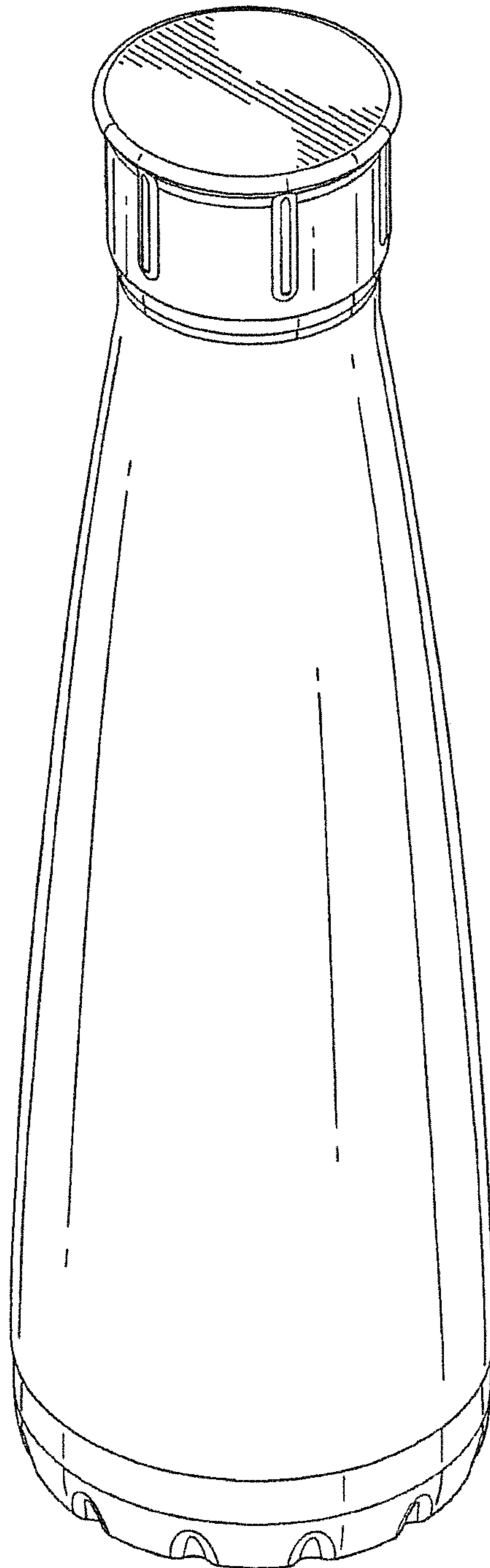

FIG. 1

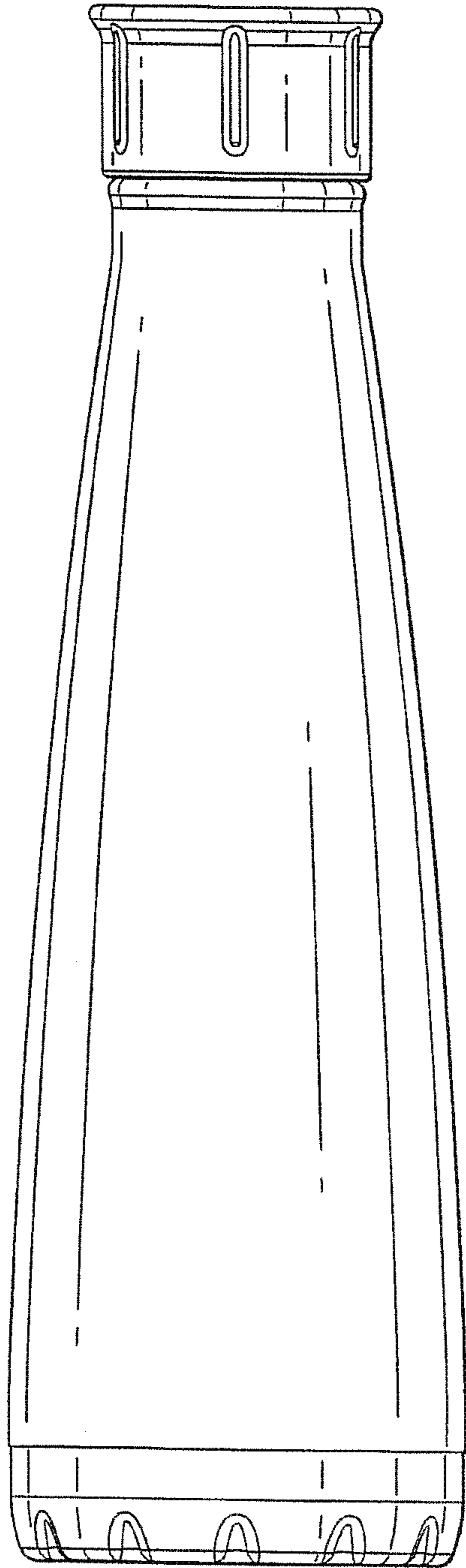

FIG. 2

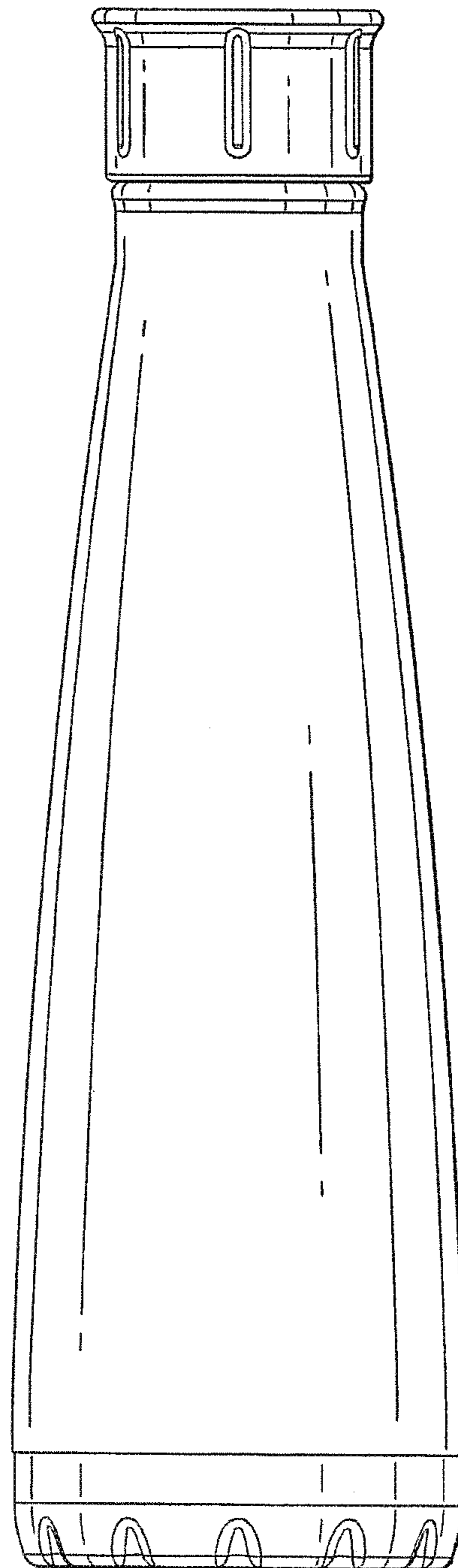

FIG. 3

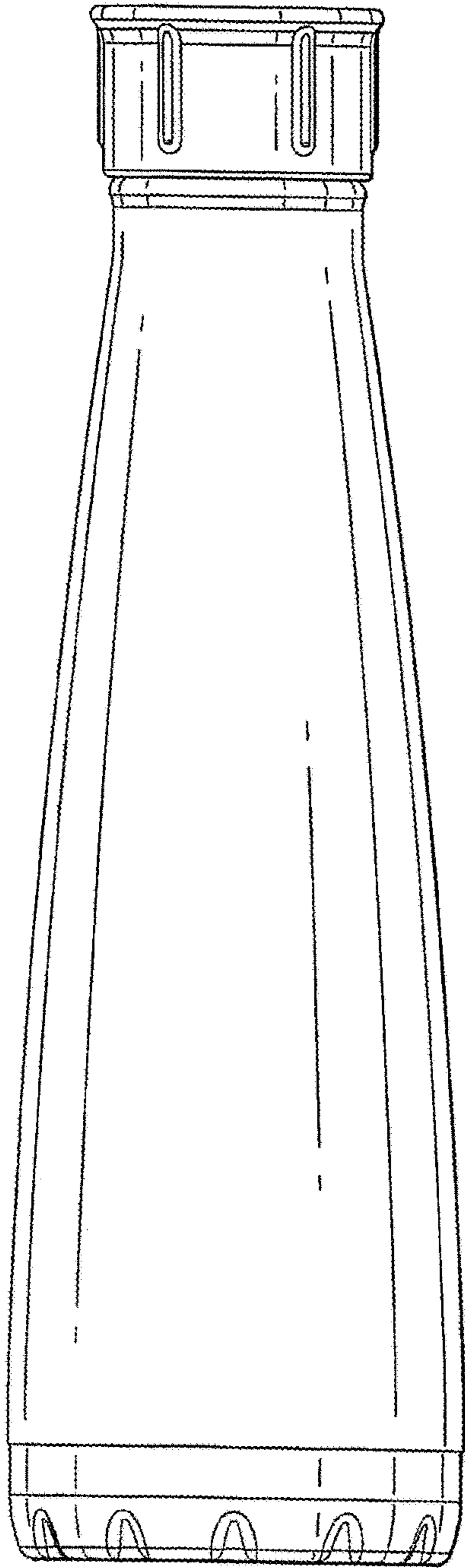

FIG. 4

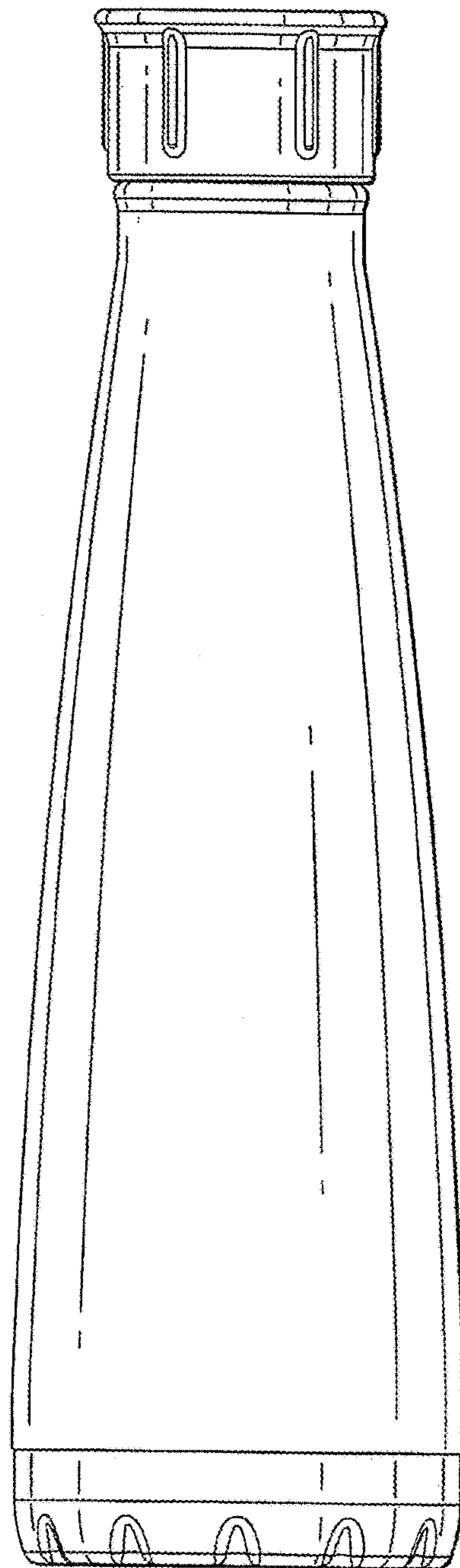

FIG. 5

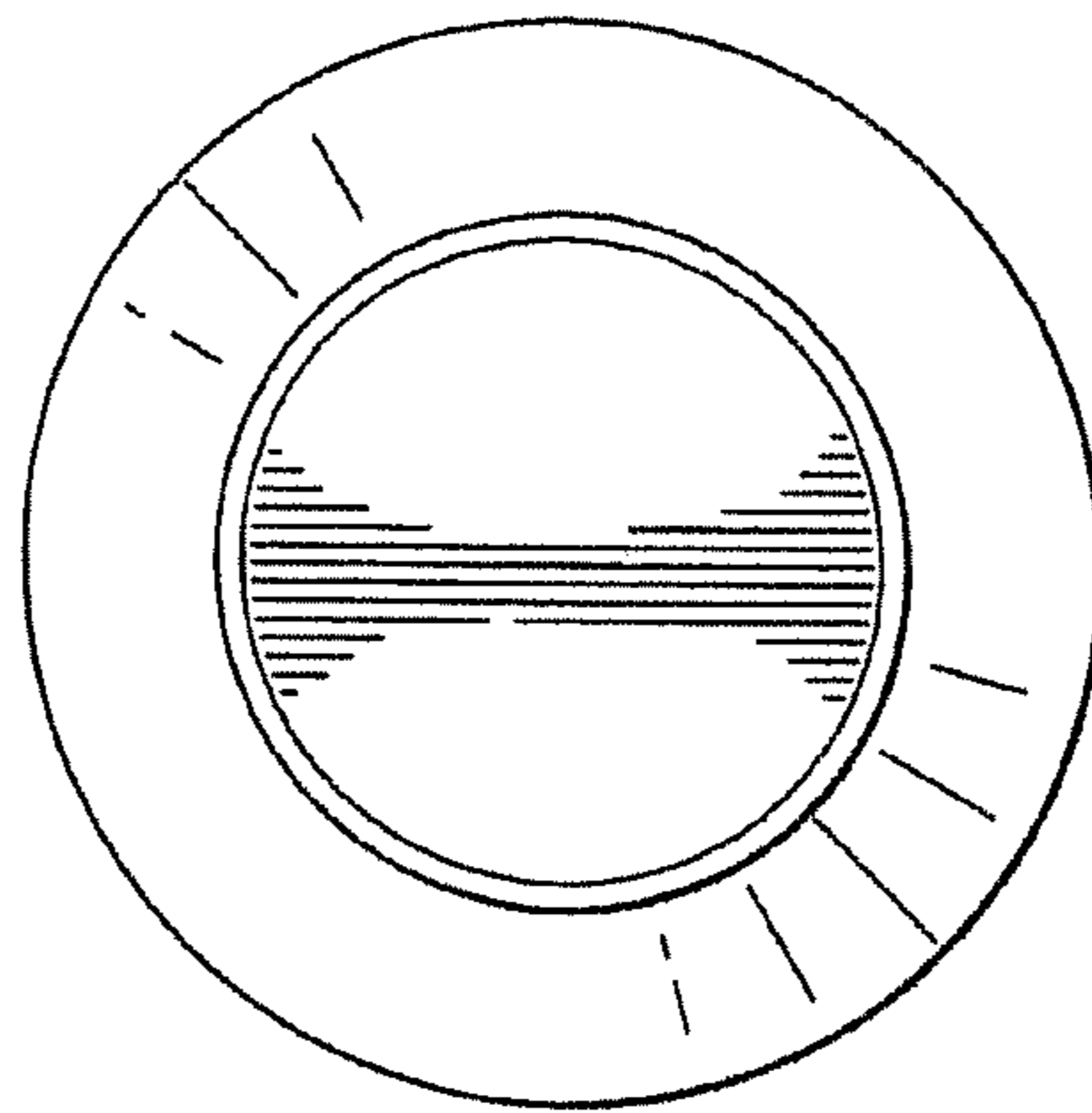

FIG. 6

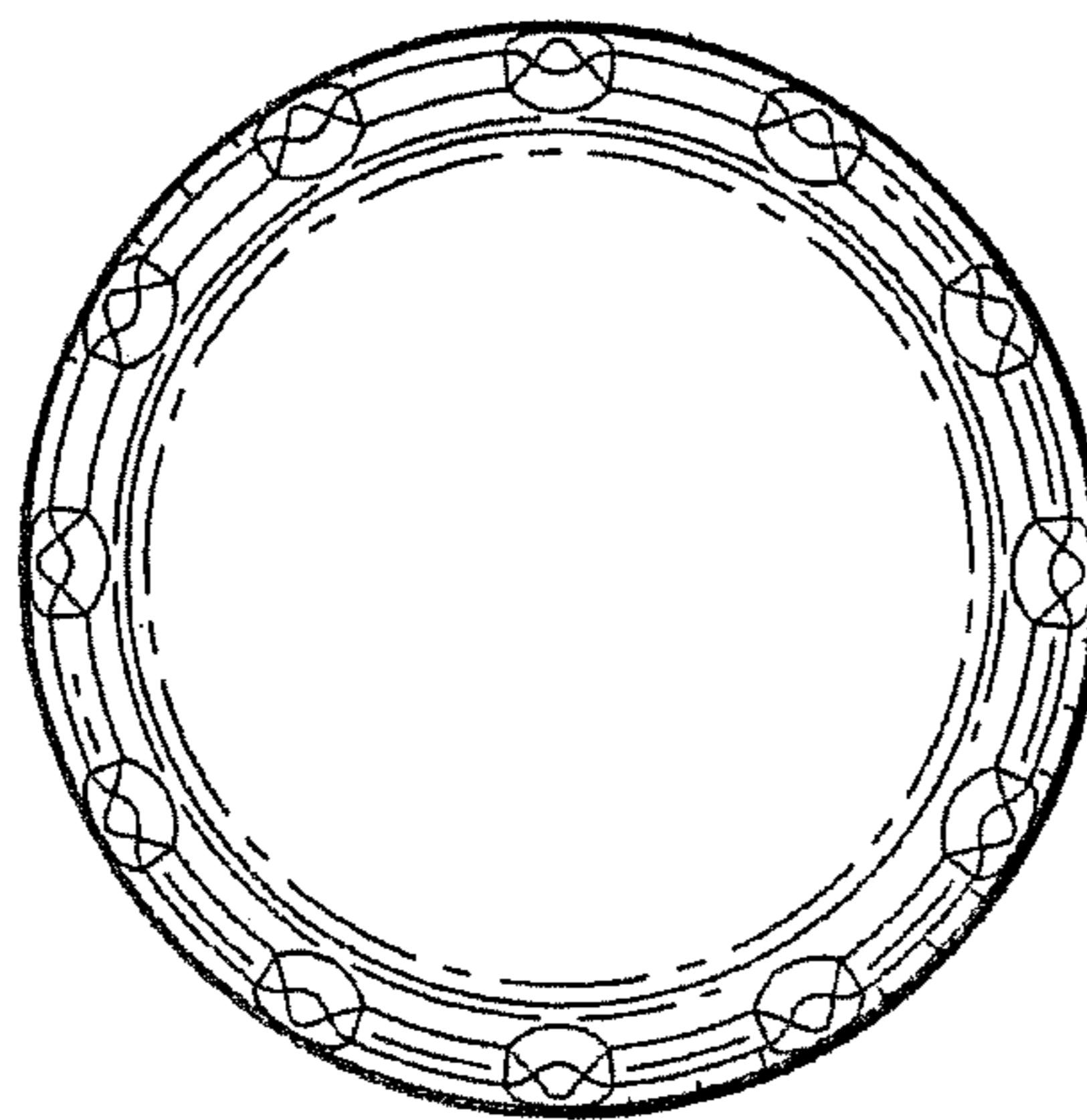

FIG. 7

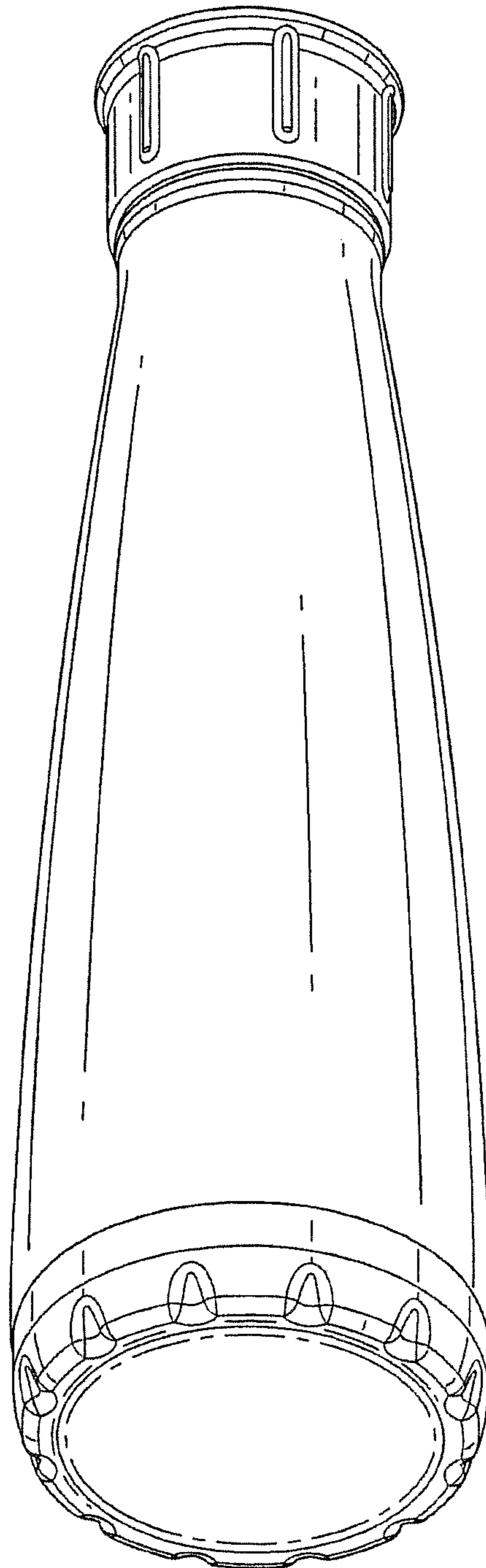

FIG. 8

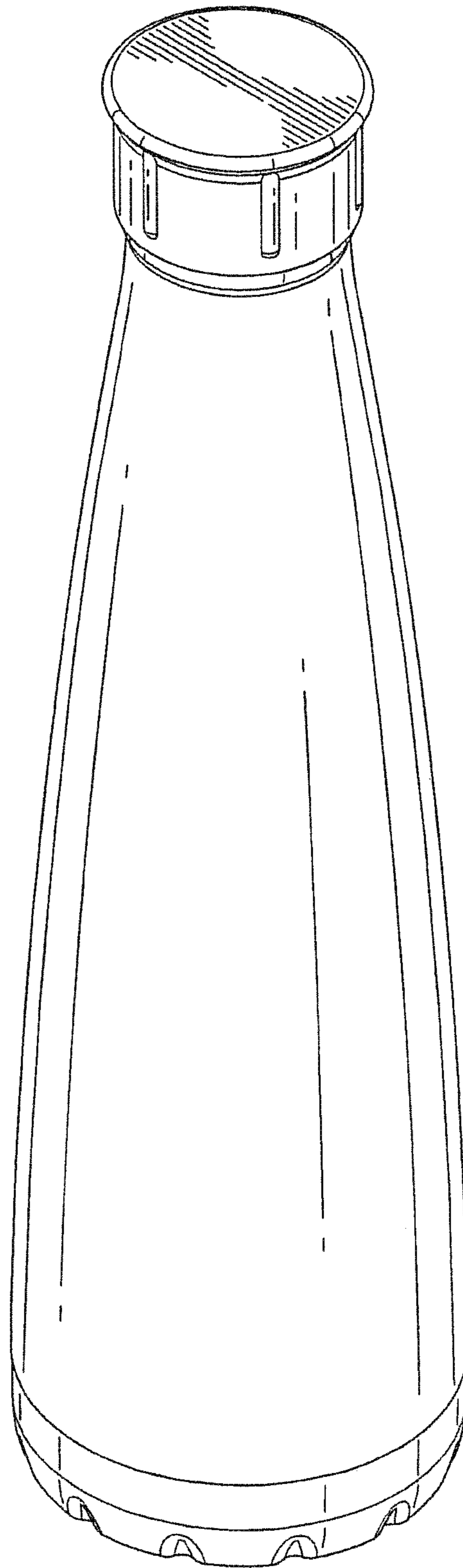

FIG. 9

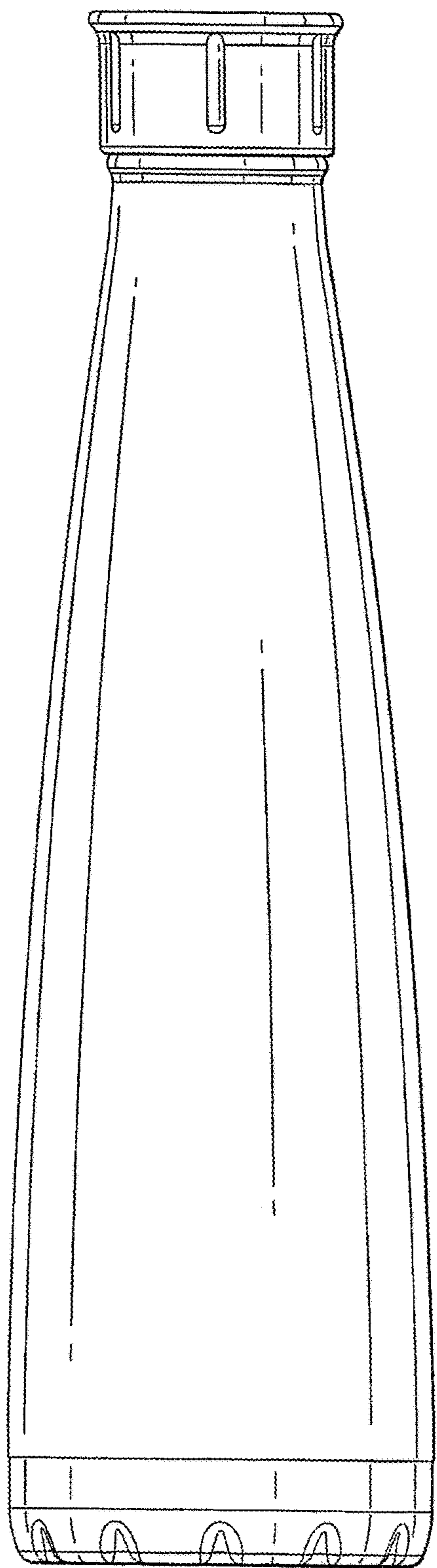

FIG. 10

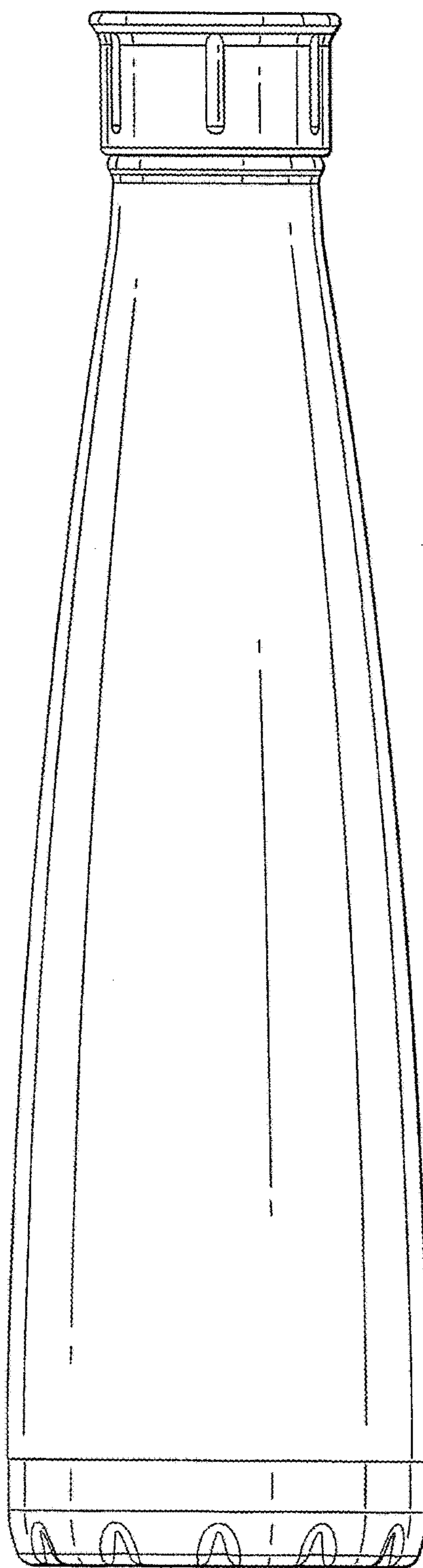

FIG. 11

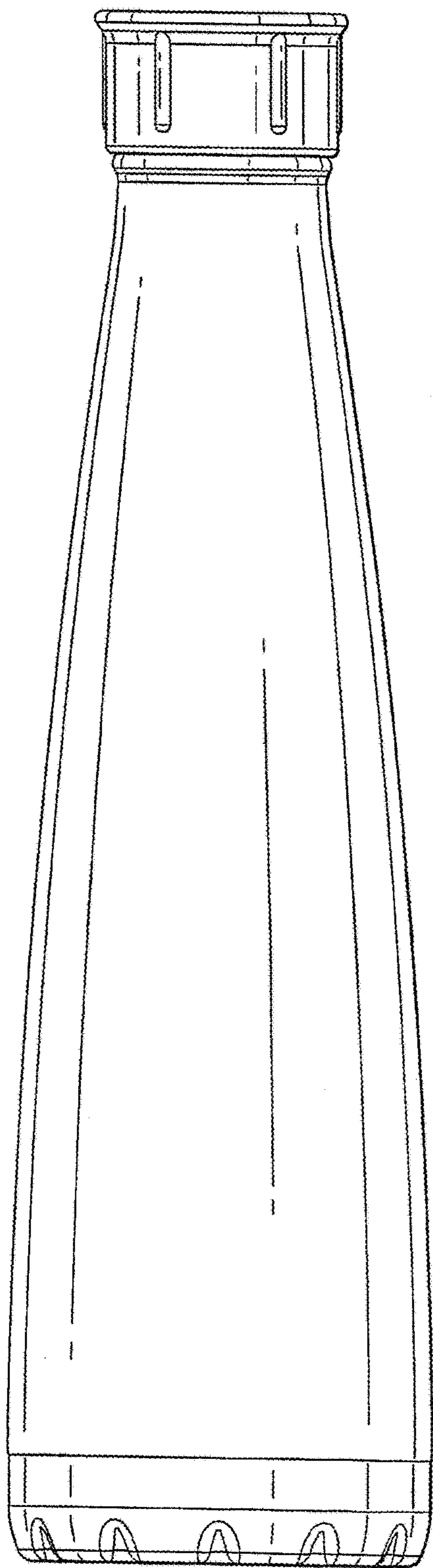

FIG. 12

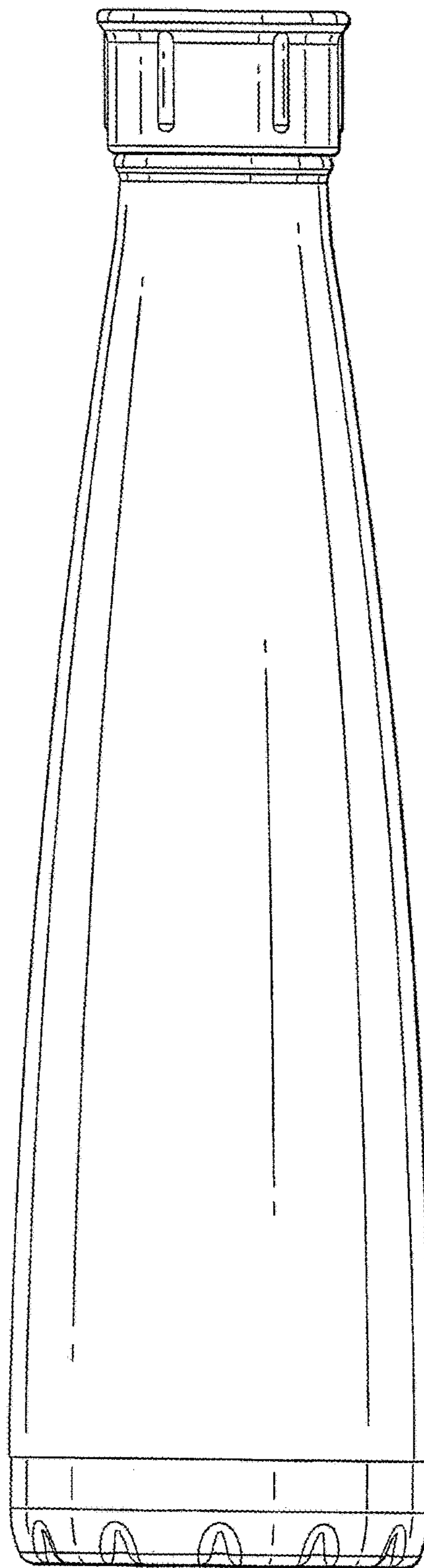

FIG. 13

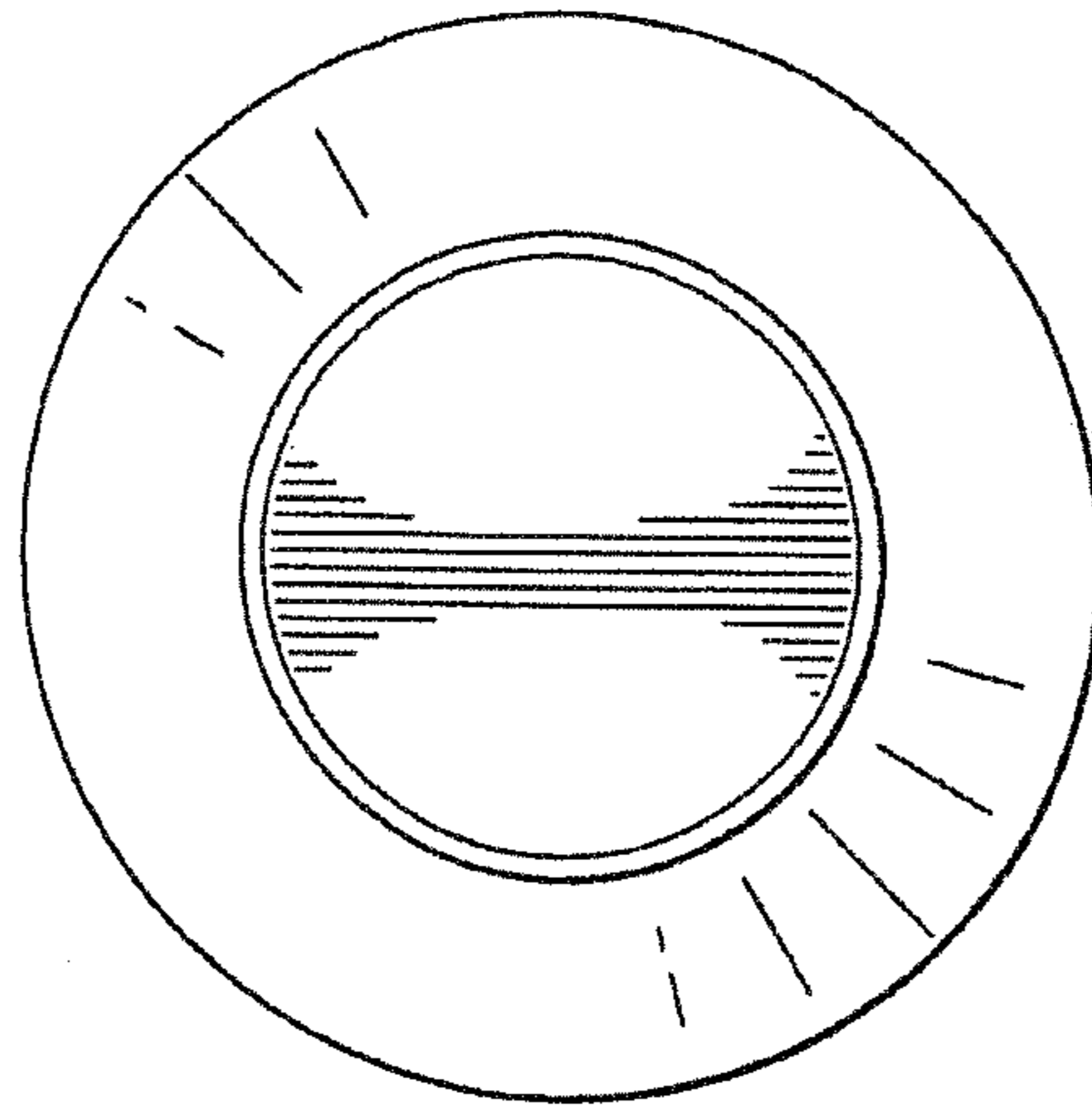

FIG. 14

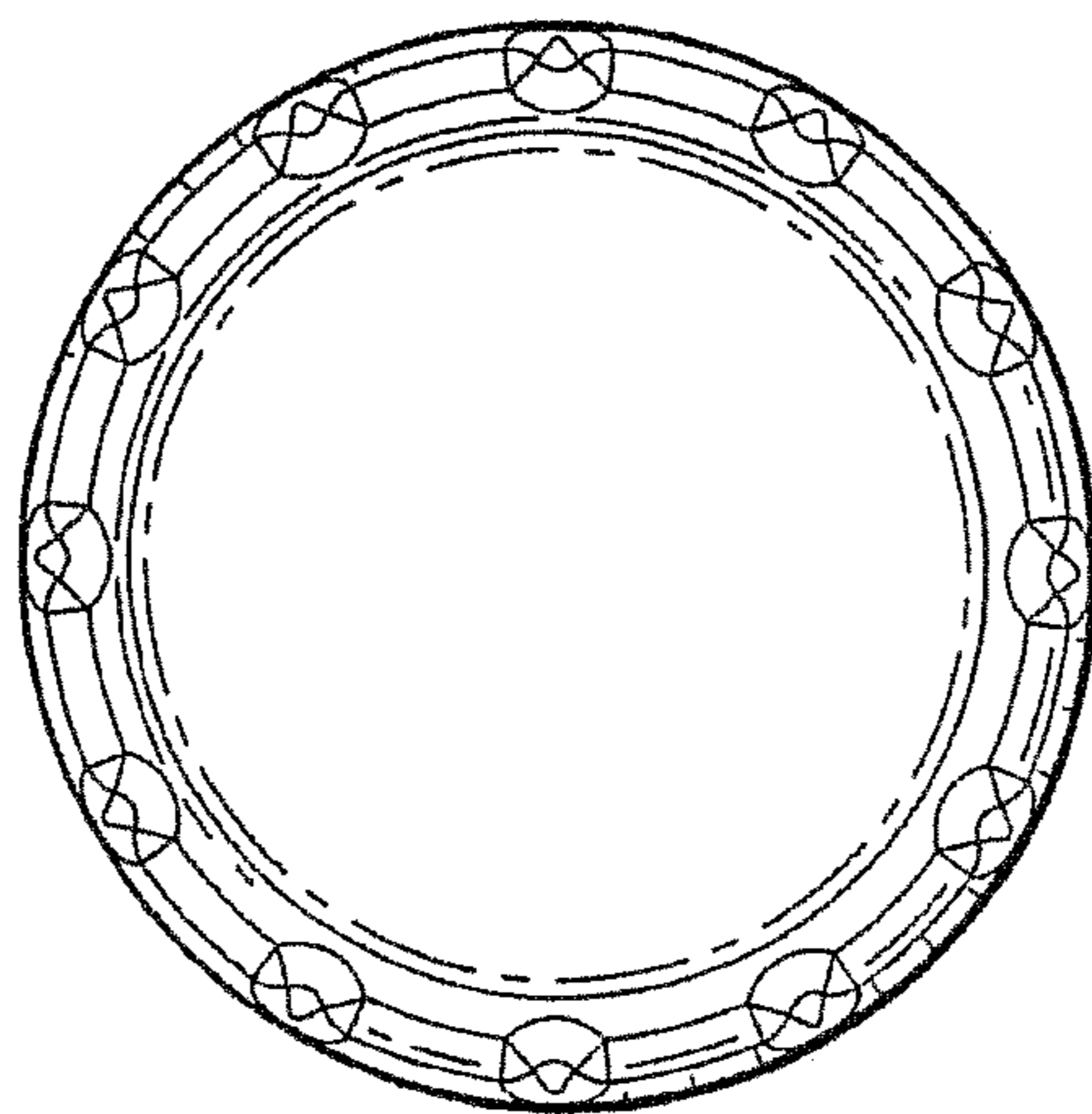

FIG. 15

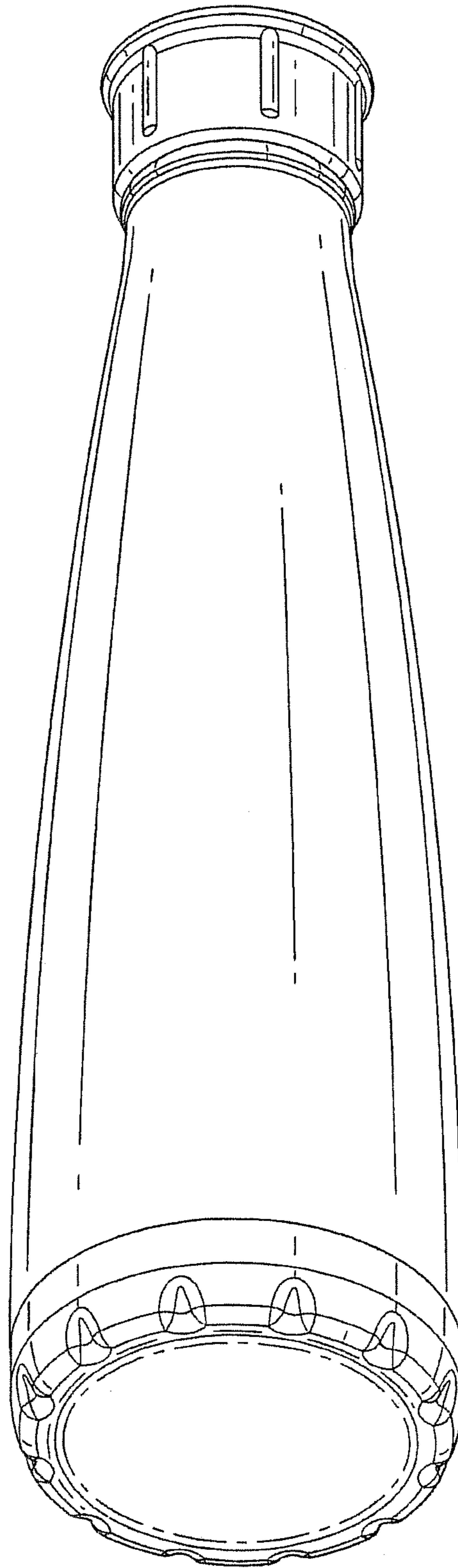

FIG. 16