



US00D817050S

(12) **United States Design Patent**
Halvorson, Jr. et al.

(10) **Patent No.:** **US D817,050 S**
(45) **Date of Patent:** **** May 8, 2018**

- (54) **CABINET BASE CORNER PORTION**
- (71) Applicant: **A-dec, Inc.**, Newberg, OR (US)
- (72) Inventors: **Harold Halvorson, Jr.**, Portland, OR (US); **Bryon A. Nichols**, Salem, OR (US)
- (73) Assignee: **A-dec, Inc.**, Newberg, OR (US)
- (**) Term: **15 Years**
- (21) Appl. No.: **29/554,513**
- (22) Filed: **Feb. 11, 2016**
- (51) **LOC (11) Cl.** **06-04**
- (52) **U.S. Cl.**
USPC **D6/708**
- (58) **Field of Classification Search**
USPC D6/657, 663, 668, 668.1, 668.2, 671, D6/671.1, 671.2, 671.3, 671.4, 708
CPC A47B 17/04; A47B 45/00; A47B 47/00; A47B 47/03; A47B 67/00; A47B 67/04; A47B 67/005; A47B 87/00
See application file for complete search history.

- D642,400 S * 8/2011 Koehn D6/668.1
- D663,134 S * 7/2012 Wu D6/708
- D714,578 S * 10/2014 Woods D6/708
- D715,076 S * 10/2014 Duvigneau D6/668.2
- D718,560 S * 12/2014 Denby D6/708

* cited by examiner

Primary Examiner — Mimoso De
(74) *Attorney, Agent, or Firm* — Klarquist Sparkman, LLP

(57) **CLAIM**

The ornamental design for a cabinet base corner portion, as shown and described.

DESCRIPTION

FIG. 1 is a perspective view of a cabinet base corner portion in use condition.
 FIG. 2 is a front elevational view of the cabinet base corner portion.
 FIG. 3 is a rear elevational view thereof.
 FIG. 4 is a right side elevational view thereof.
 FIG. 5 is a left side elevational view thereof.
 FIG. 6 is a top plan view thereof.
 FIG. 7 is a bottom plan view thereof.
 FIG. 8 is a perspective view of a cabinet base corner portion according to an alternative embodiment in use condition.
 FIG. 9 is a front elevational view of the cabinet base corner portion according to the alternative embodiment.
 FIG. 10 is a rear elevational view thereof.
 FIG. 11 is a right side elevational view thereof.
 FIG. 12 is a left side elevational view thereof.
 FIG. 13 is a top plan view thereof; and,
 FIG. 14 is a bottom plan view thereof.
 The broken line showings of portions of the rear of the cabinet base corner portion form no part of the claimed design. The broken line showings of cabinet base side pieces illustrate the environment of the claimed design and form no part thereof.

(56) **References Cited**

U.S. PATENT DOCUMENTS

- D96,029 S * 6/1935 Fox D6/708
- D141,125 S * 5/1945 Stanitz D6/668.2
- D146,377 S * 2/1947 Obrig D6/657
- D149,708 S * 5/1948 Travis D6/657
- D150,825 S * 9/1948 Buckner D6/668.2
- D157,081 S * 1/1950 Paden D6/657
- D300,788 S * 4/1989 Crawley D6/657
- D368,604 S * 4/1996 Gotham D6/657
- D387,223 S * 12/1997 Brunner D6/668.1
- D390,044 S * 2/1998 Brunner D6/668.2
- D518,310 S * 4/2006 Mehmen D6/668.1
- D520,264 S * 5/2006 Mehmen D6/668.1
- D600,956 S * 9/2009 Suarez D6/708
- D627,994 S * 11/2010 Wahl D6/708
- D634,950 S * 3/2011 Wahl D6/708

1 Claim, 6 Drawing Sheets

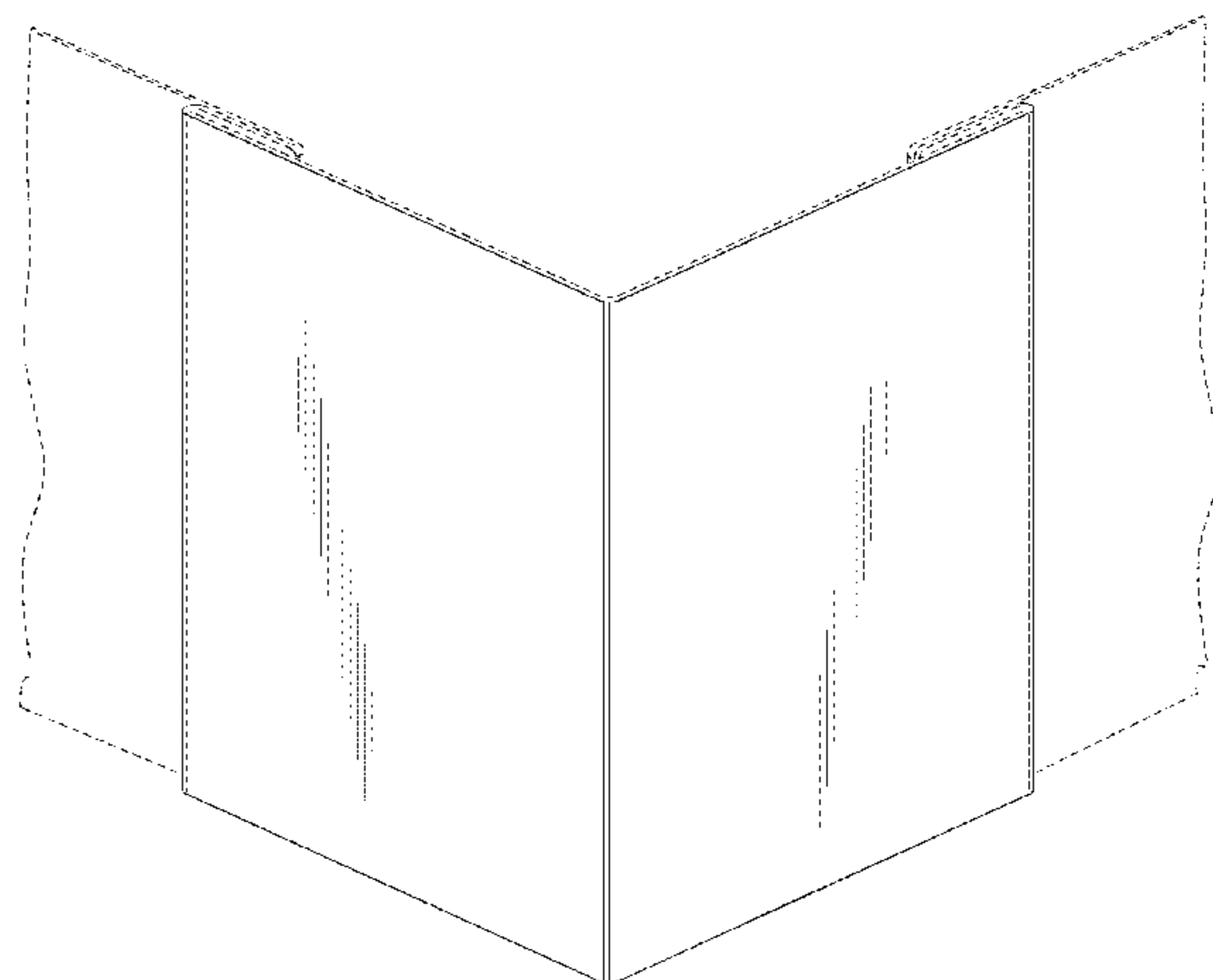
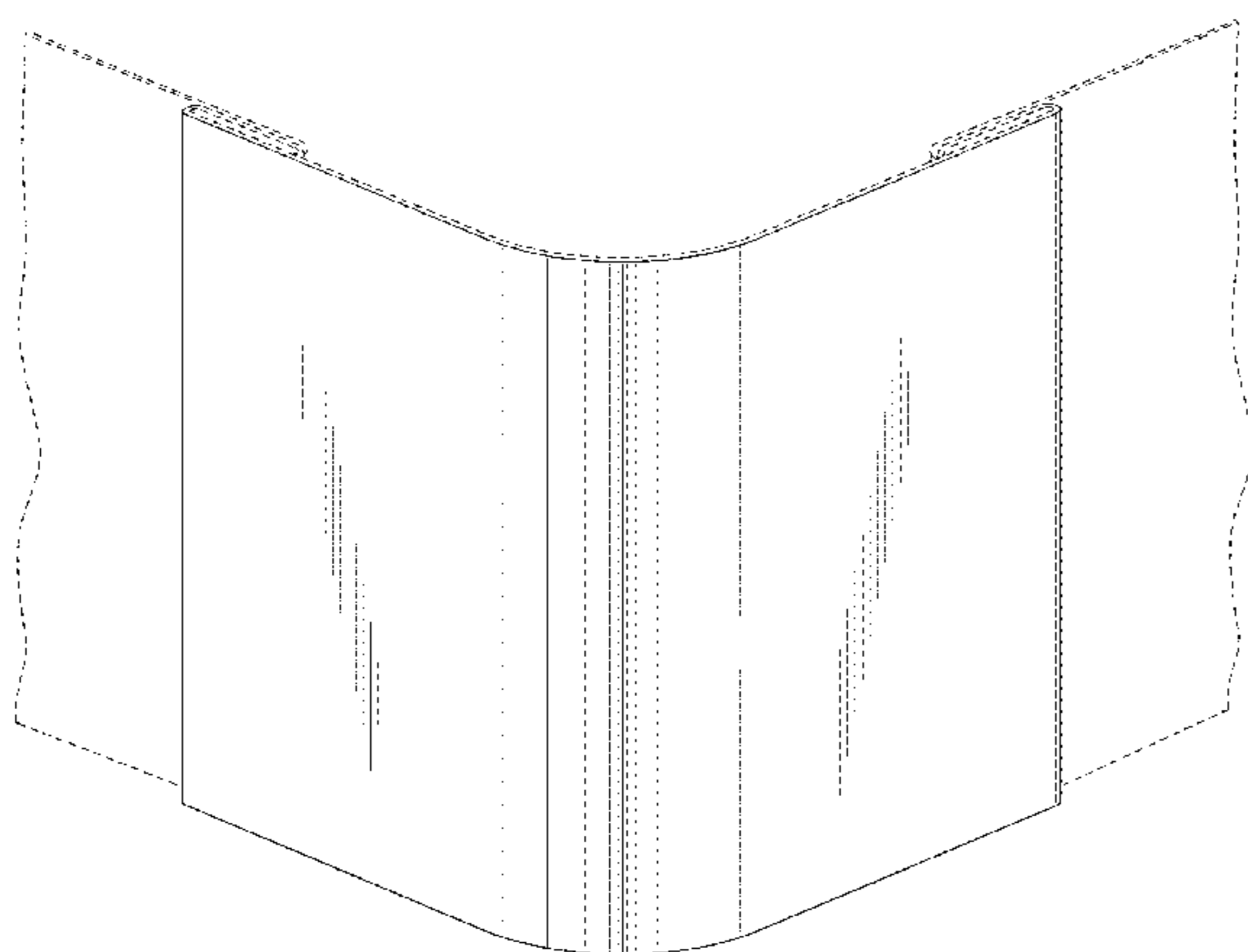

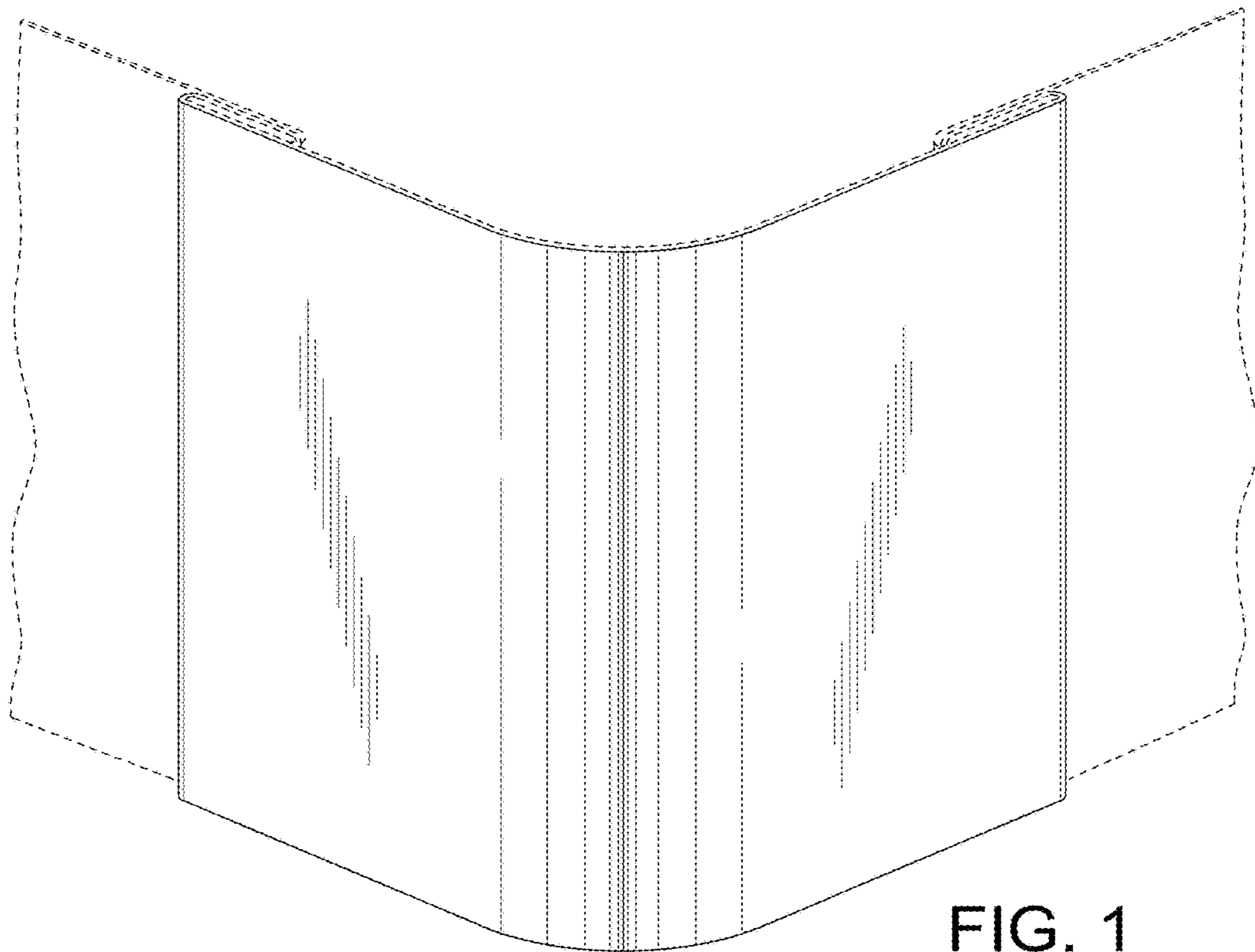

FIG. 1

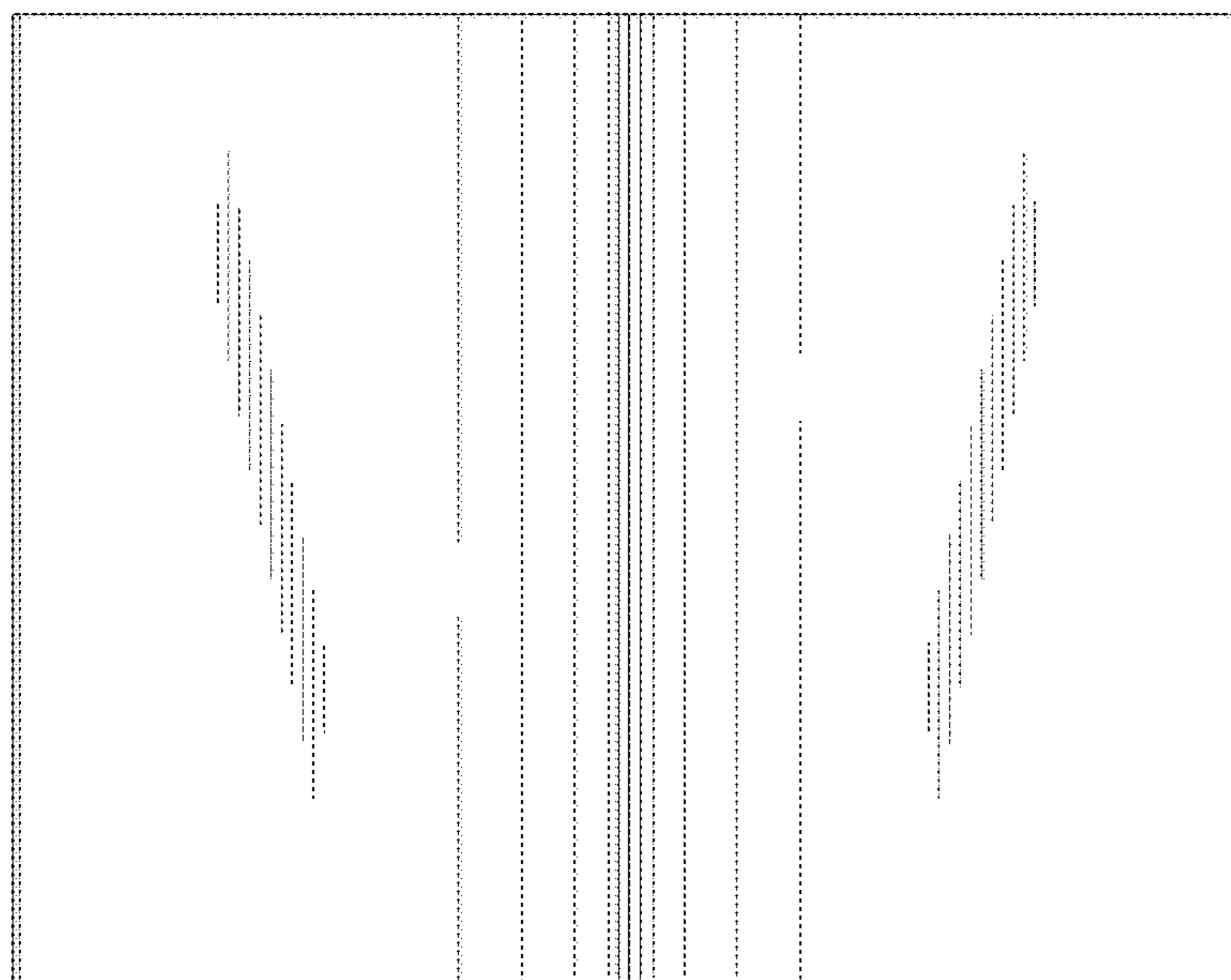

FIG. 2

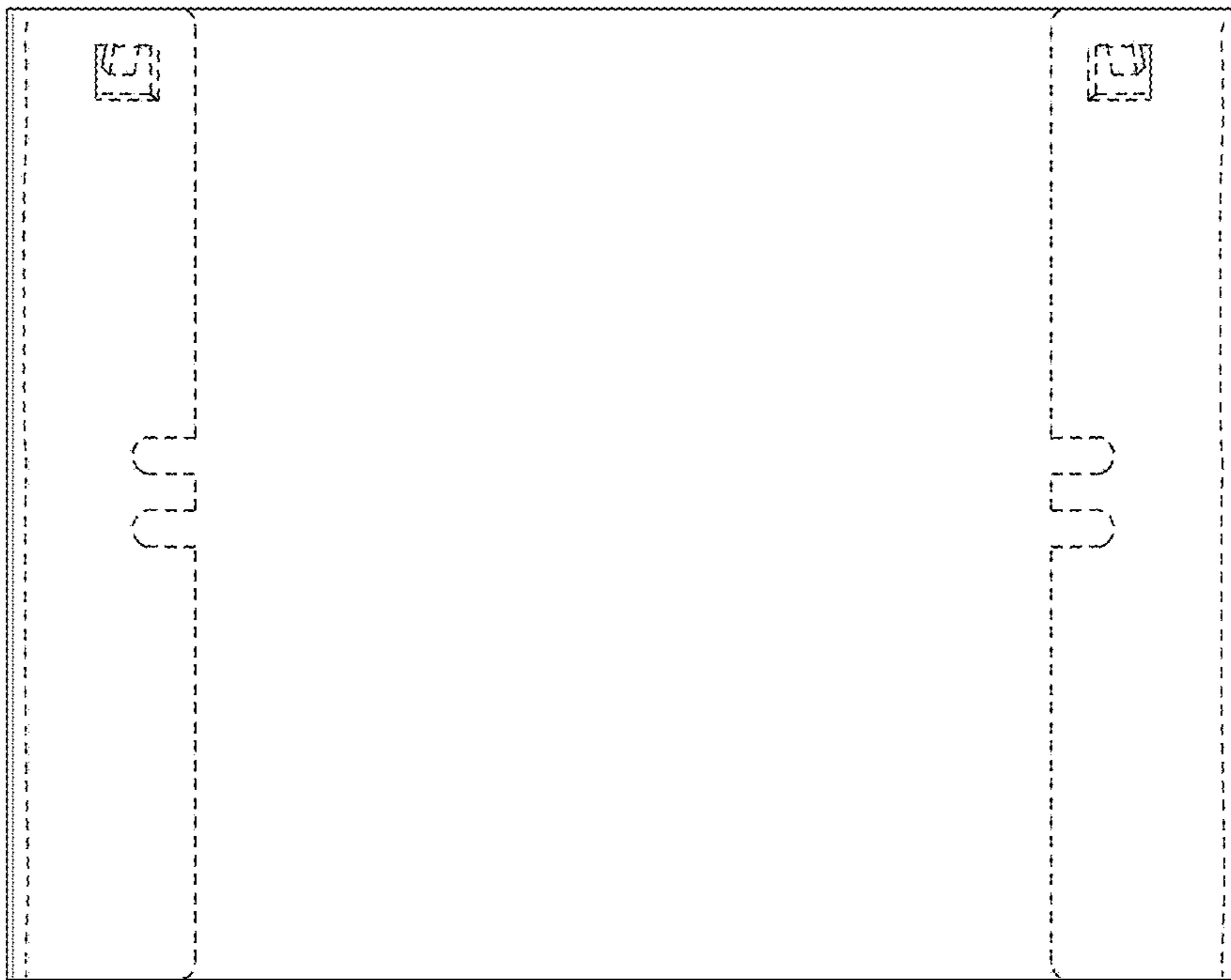

FIG. 3

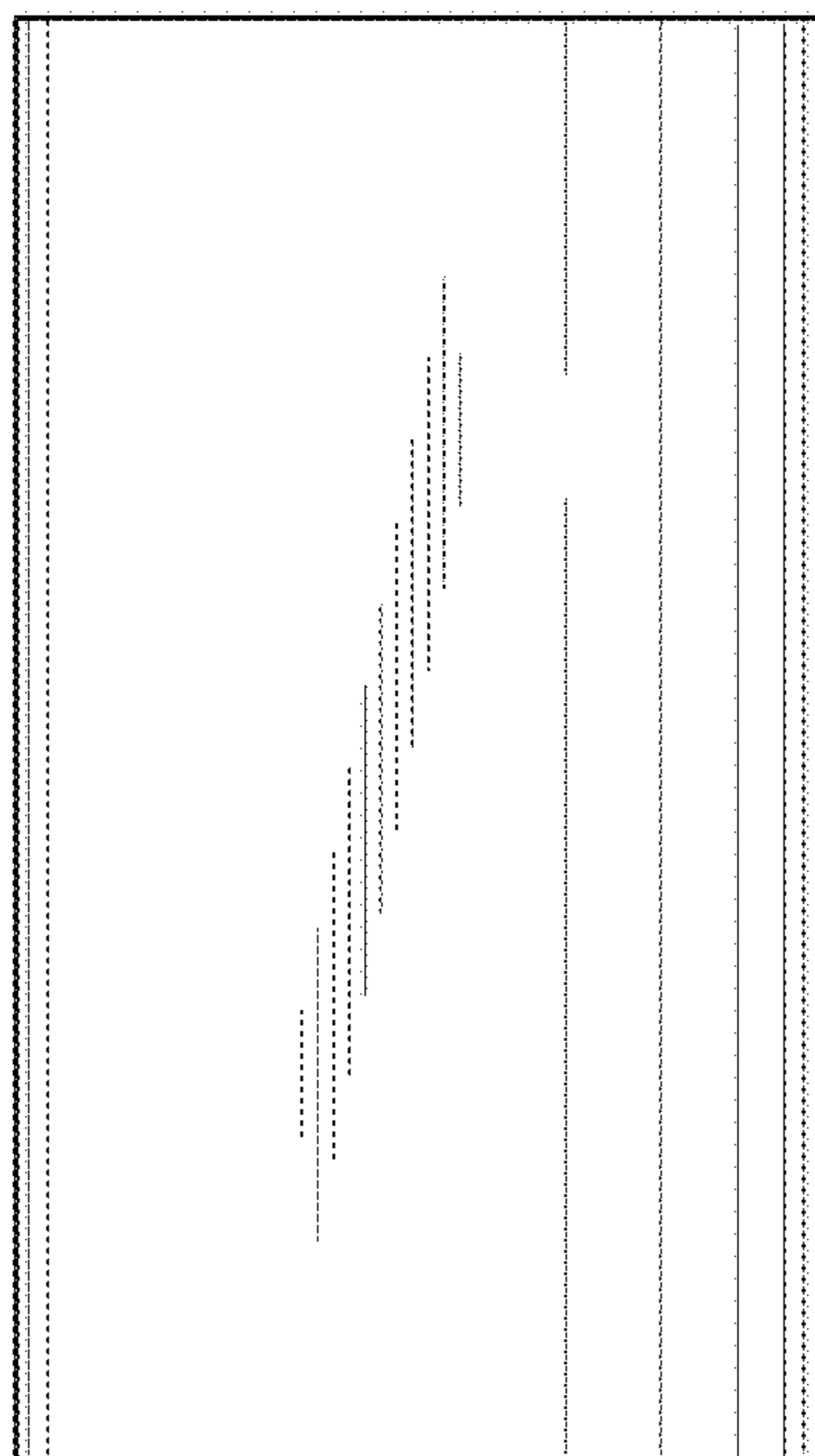

FIG. 4

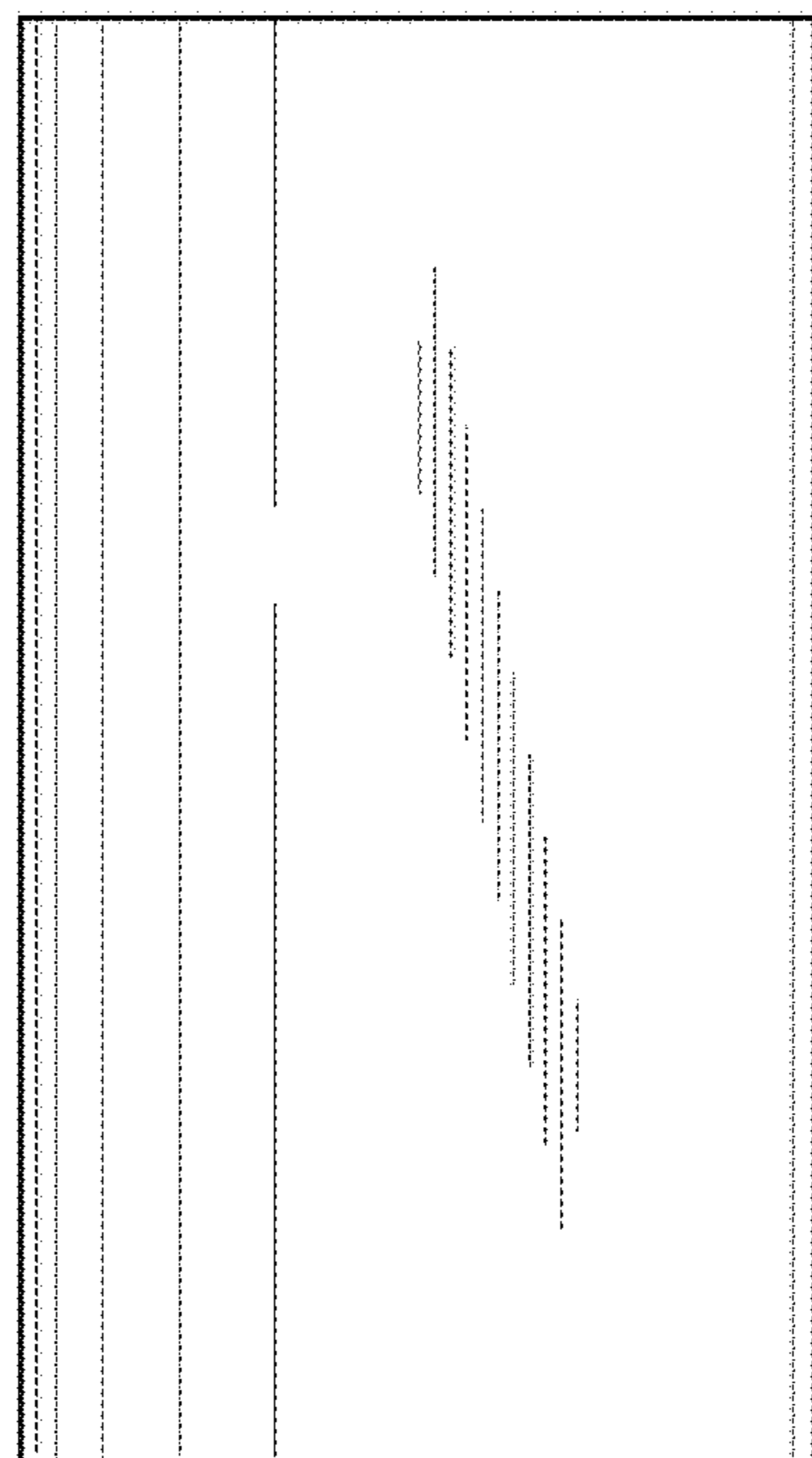

FIG. 5

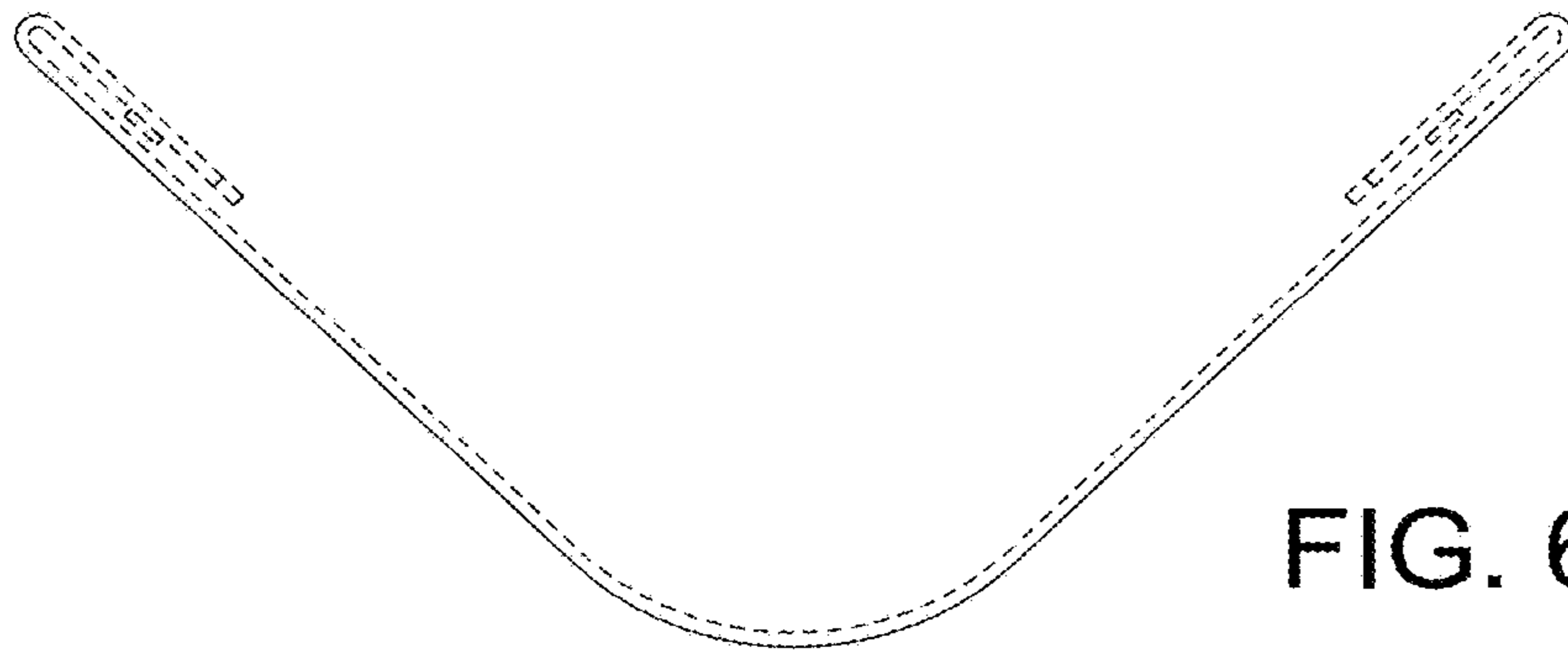

FIG. 6

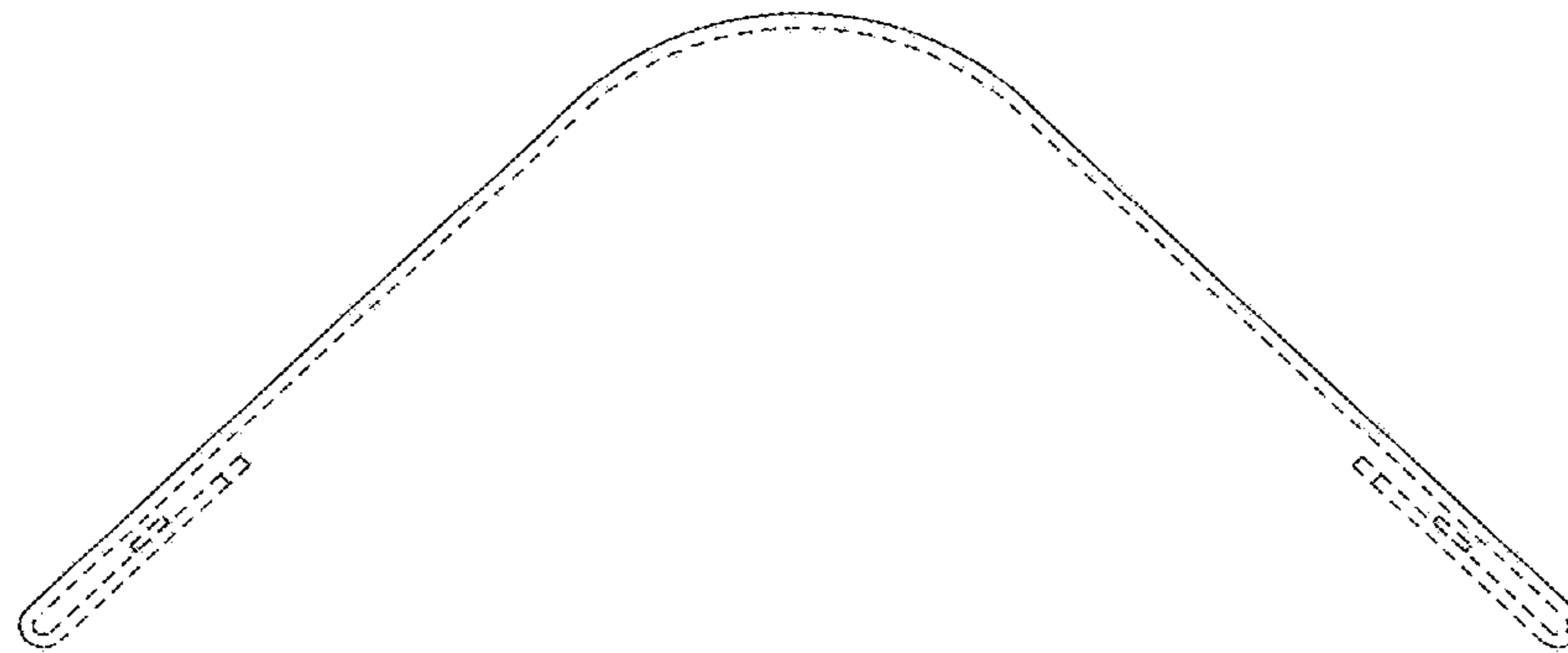

FIG. 7

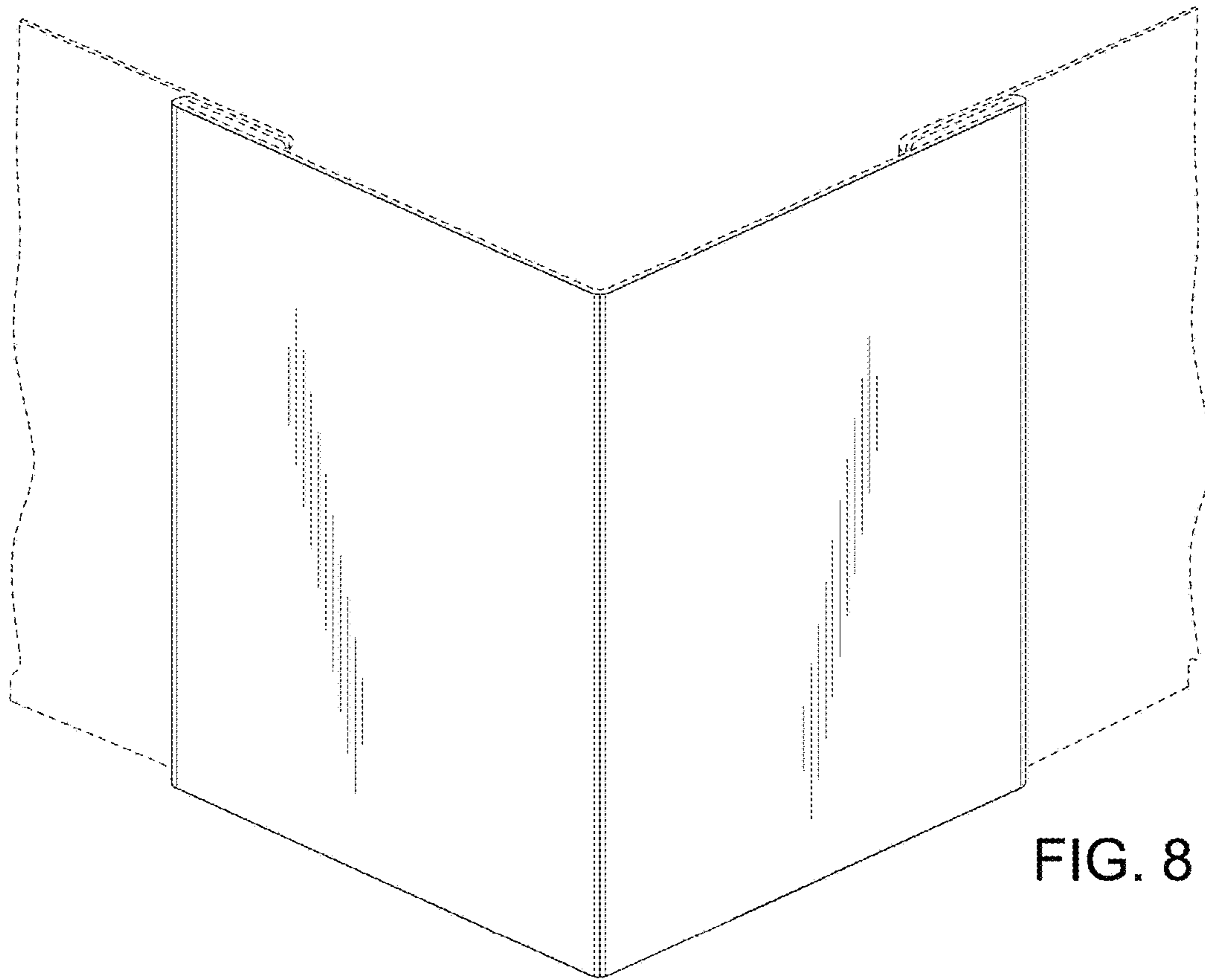

FIG. 8

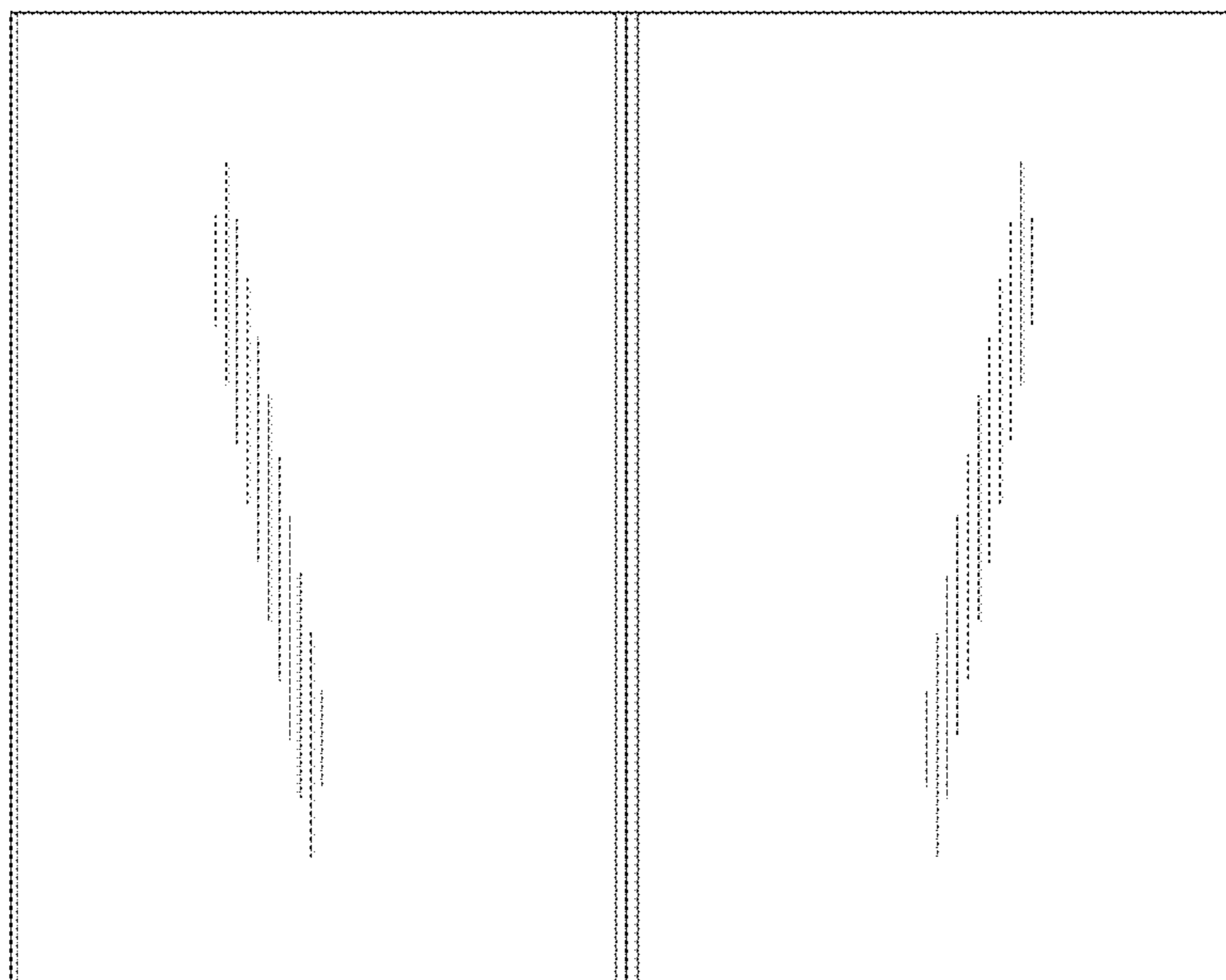

FIG. 9

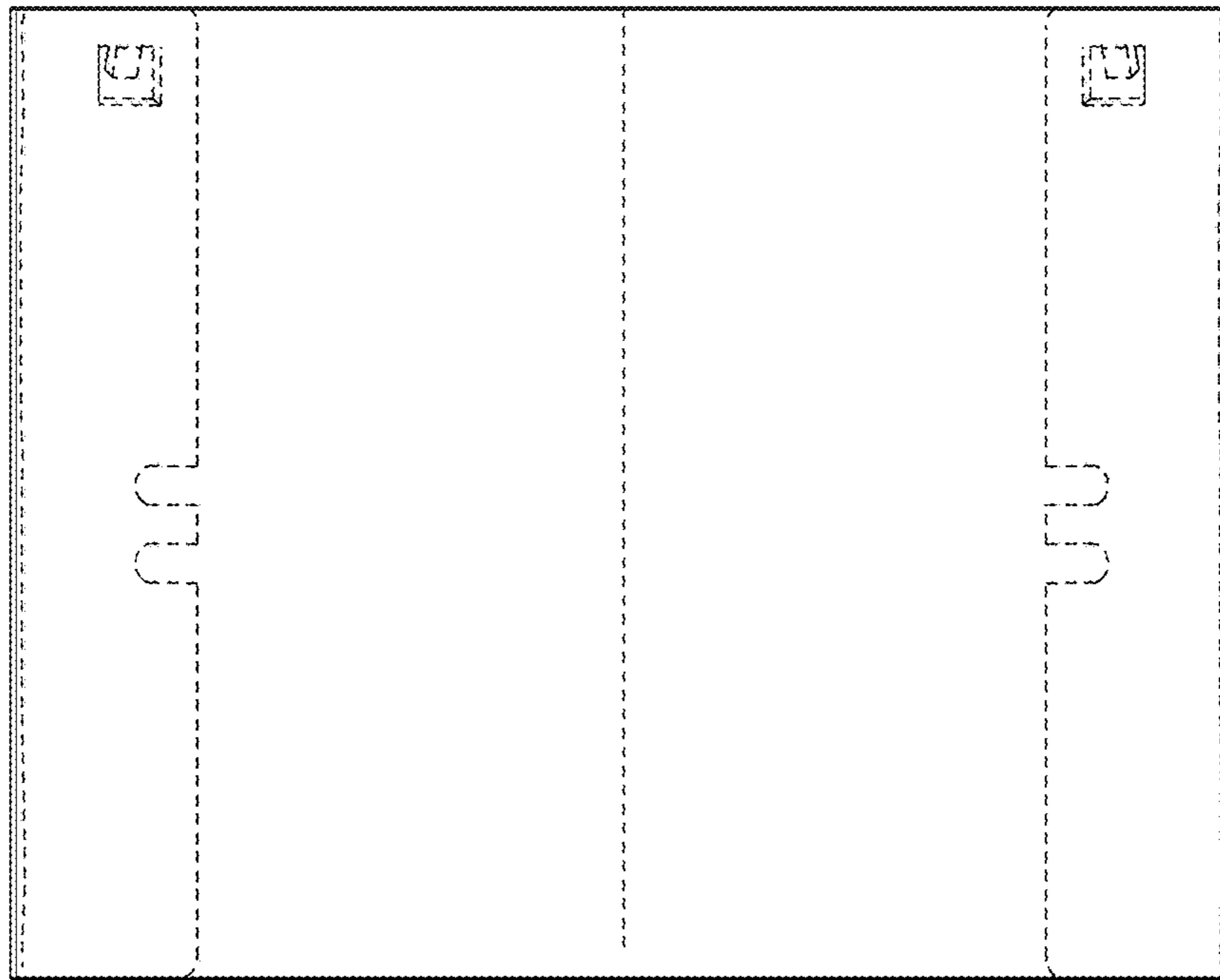

FIG. 10

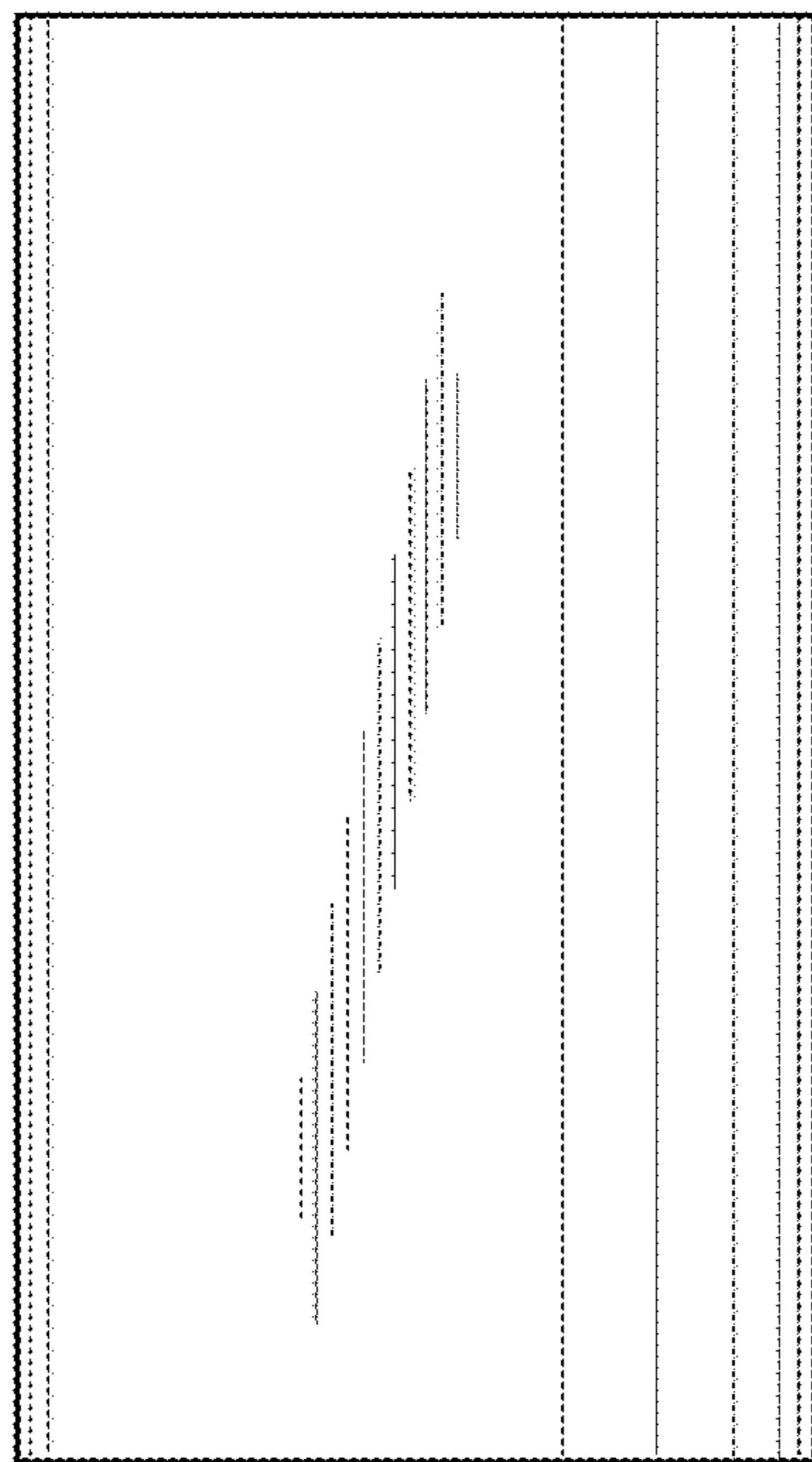

FIG. 11

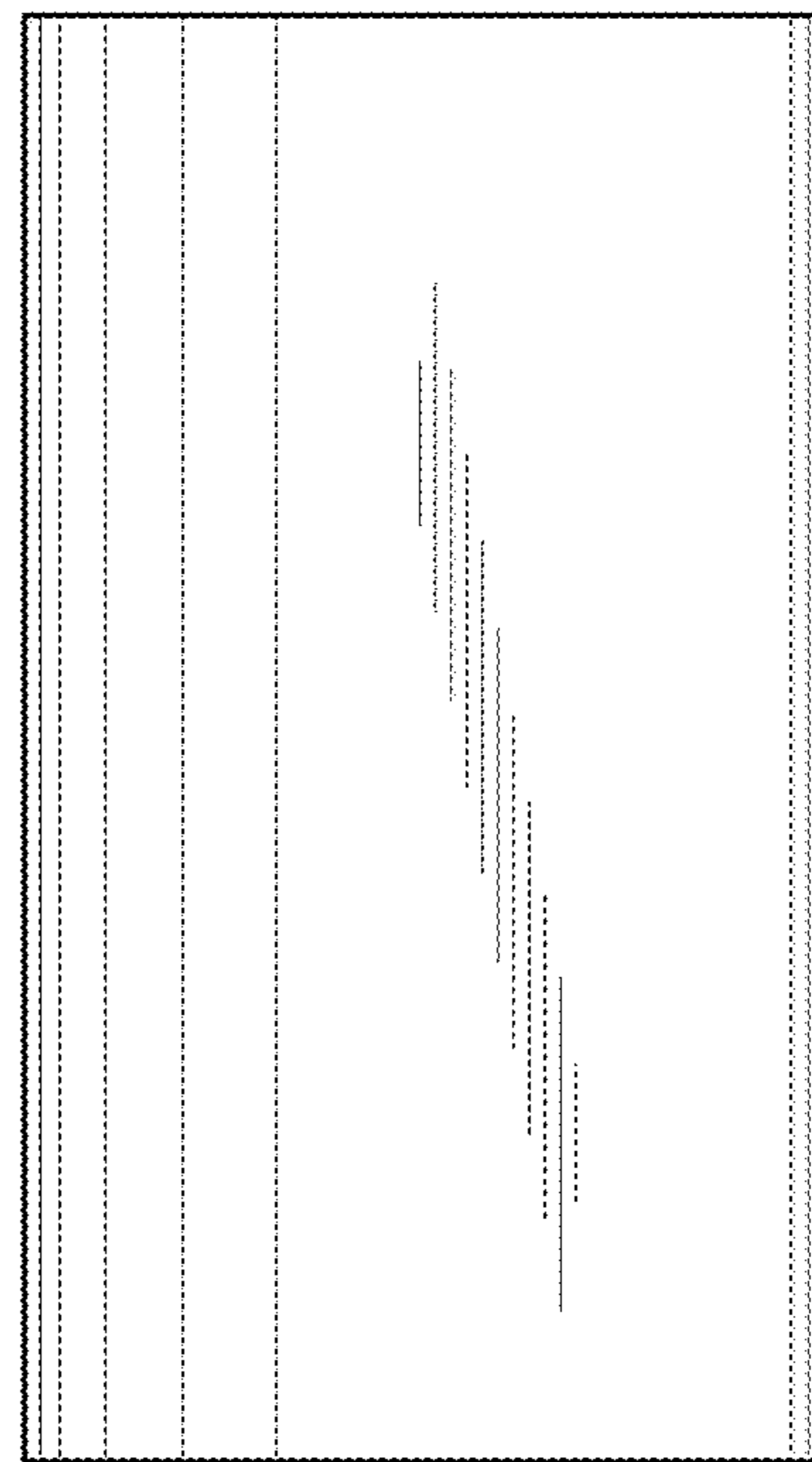

FIG. 12

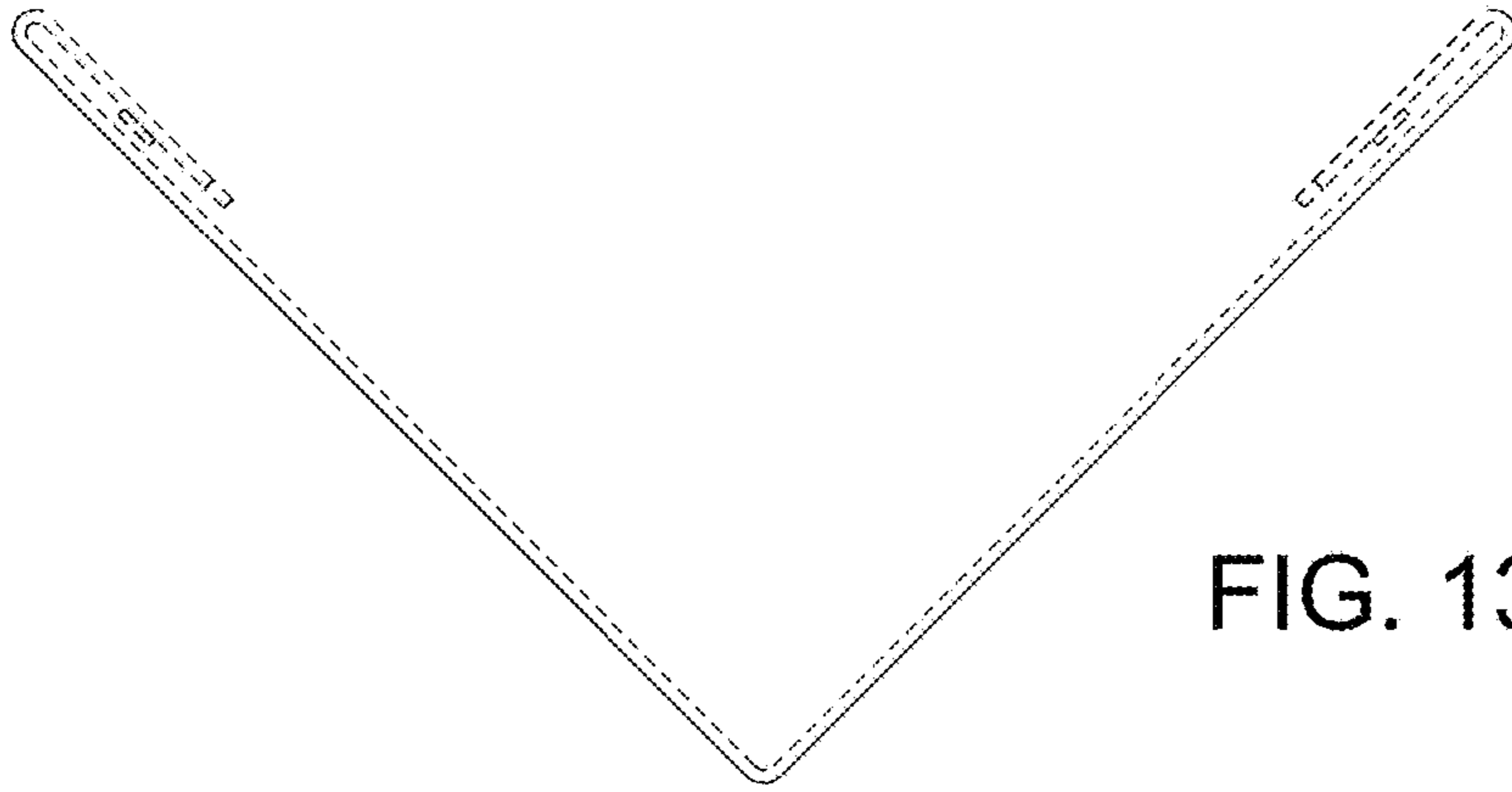

FIG. 13

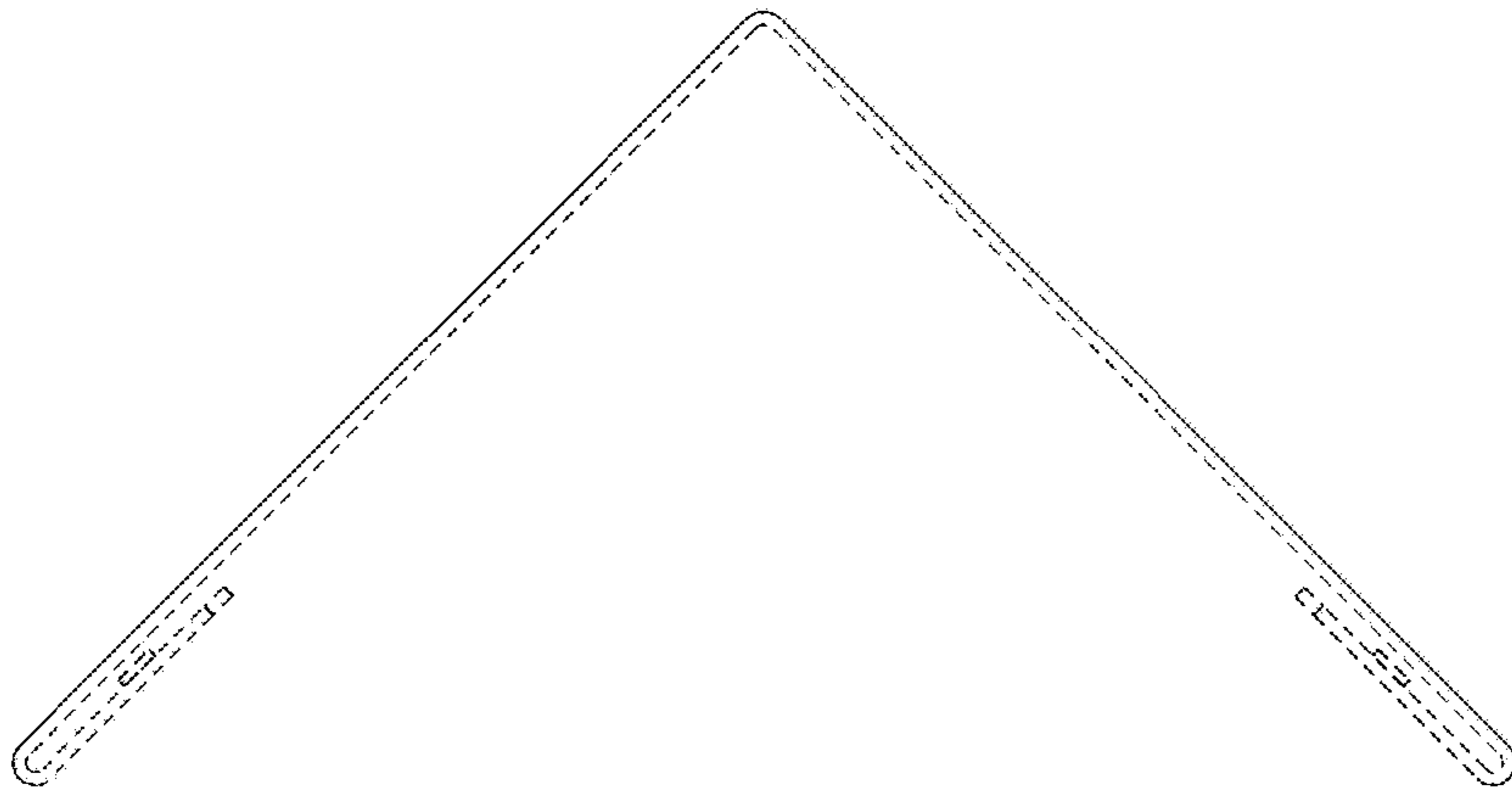

FIG. 14