



US00D817024S

(12) **United States Design Patent** (10) **Patent No.:** **US D817,024 S**  
**Venigalla** (45) **Date of Patent:** **\*\* May 8, 2018**

(54) **SPONGY SOAP DISPENSER**

(71) Applicant: **VERILY PRODUCTS GROUP LLC**,  
Glen Head, NY (US)

(72) Inventor: **Rajendraprasad Venigalla**, Glen Head,  
NY (US)

(\*\*) Term: **15 Years**

(21) Appl. No.: **29/595,403**

(22) Filed: **Feb. 28, 2017**

(51) **LOC (11) Cl.** ..... **20-02**

(52) **U.S. Cl.**  
USPC ..... **D6/542**

(58) **Field of Classification Search**

USPC ..... D6/542, 543-545, 518; D9/291, 448,  
D9/449, 682, 688, 690, 694; 221/208,  
221/282, 283; 222/14, 105, 146.3, 173,  
222/180, 181.1, 181.2, 181.3, 251, 628;  
D23/356, 366

CPC . B67D 1/001; B67D 1/06; A47K 7/04; A47K  
5/12; A47K 5/1204; A47K 5/1205; A47K  
5/1207; A47K 5/08; A47K 5/1202; A47K  
5/1214; A47K 5/1215; A47K 5/14; A47K  
5/16  
See application file for complete search history.

(56) **References Cited**

**U.S. PATENT DOCUMENTS**

D613,103 S *	4/2010	Misir	.....	D6/542
D685,076 S *	6/2013	Gordon	.....	D23/366
D708,726 S *	7/2014	Gordon	.....	D23/356
D726,440 S *	4/2015	Giovannoni	.....	D6/518

\* cited by examiner

*Primary Examiner* — Wan Laymon

*Assistant Examiner* — Mark Booker

(74) *Attorney, Agent, or Firm* — Chan Hubbard PLLC;  
Keala Chan

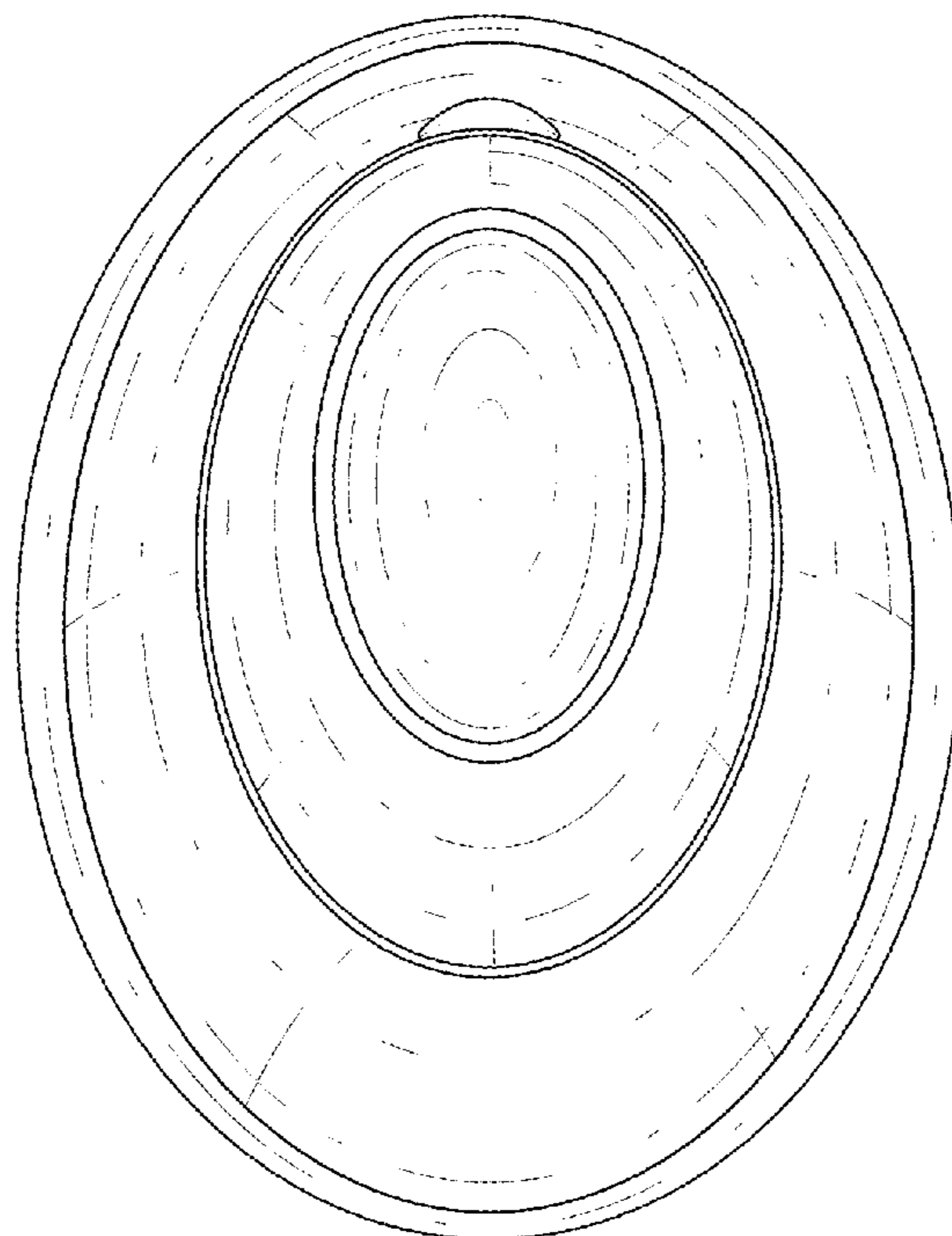
(57) **CLAIM**

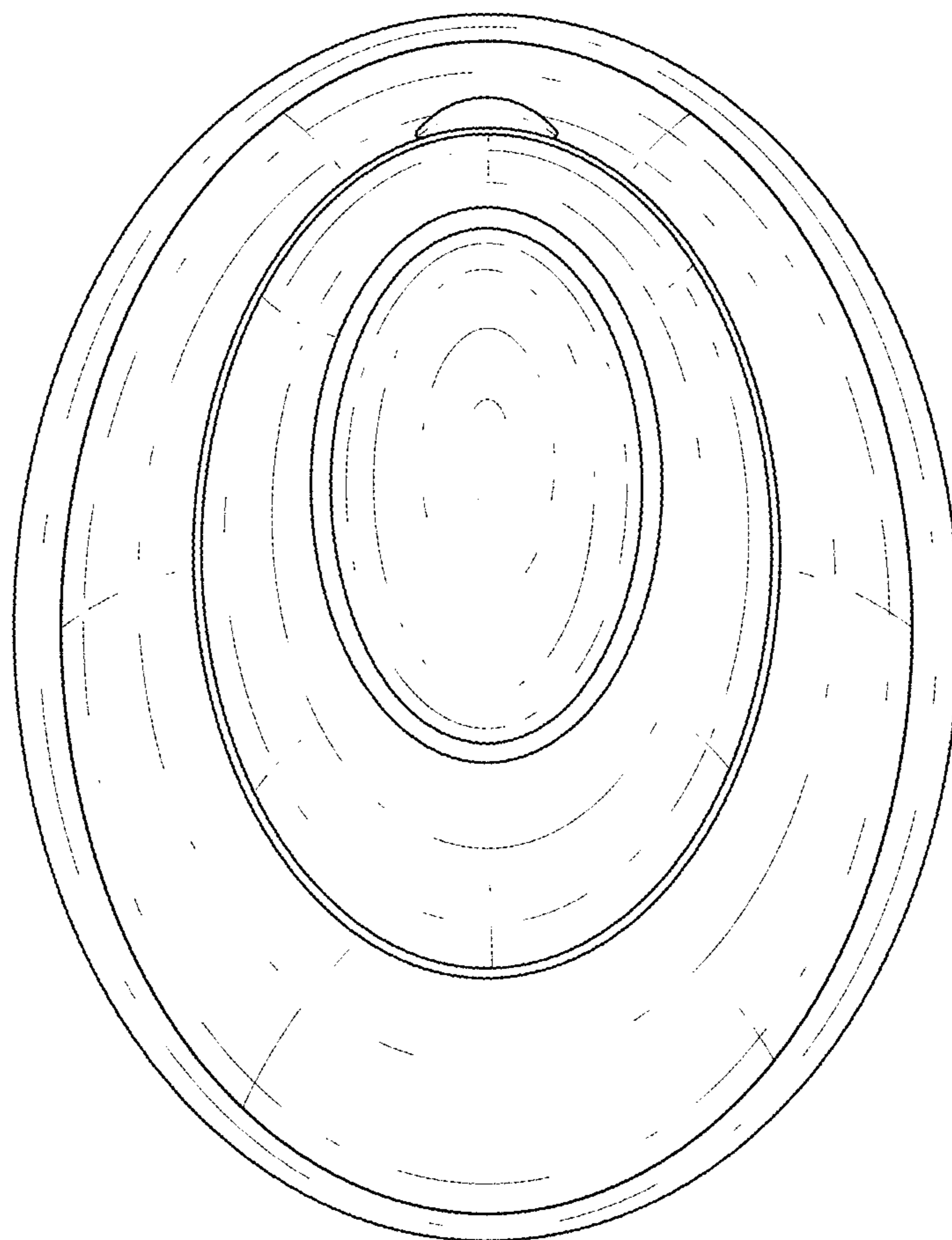
The ornamental design for a spongy soap dispenser, as shown and described.

**DESCRIPTION**

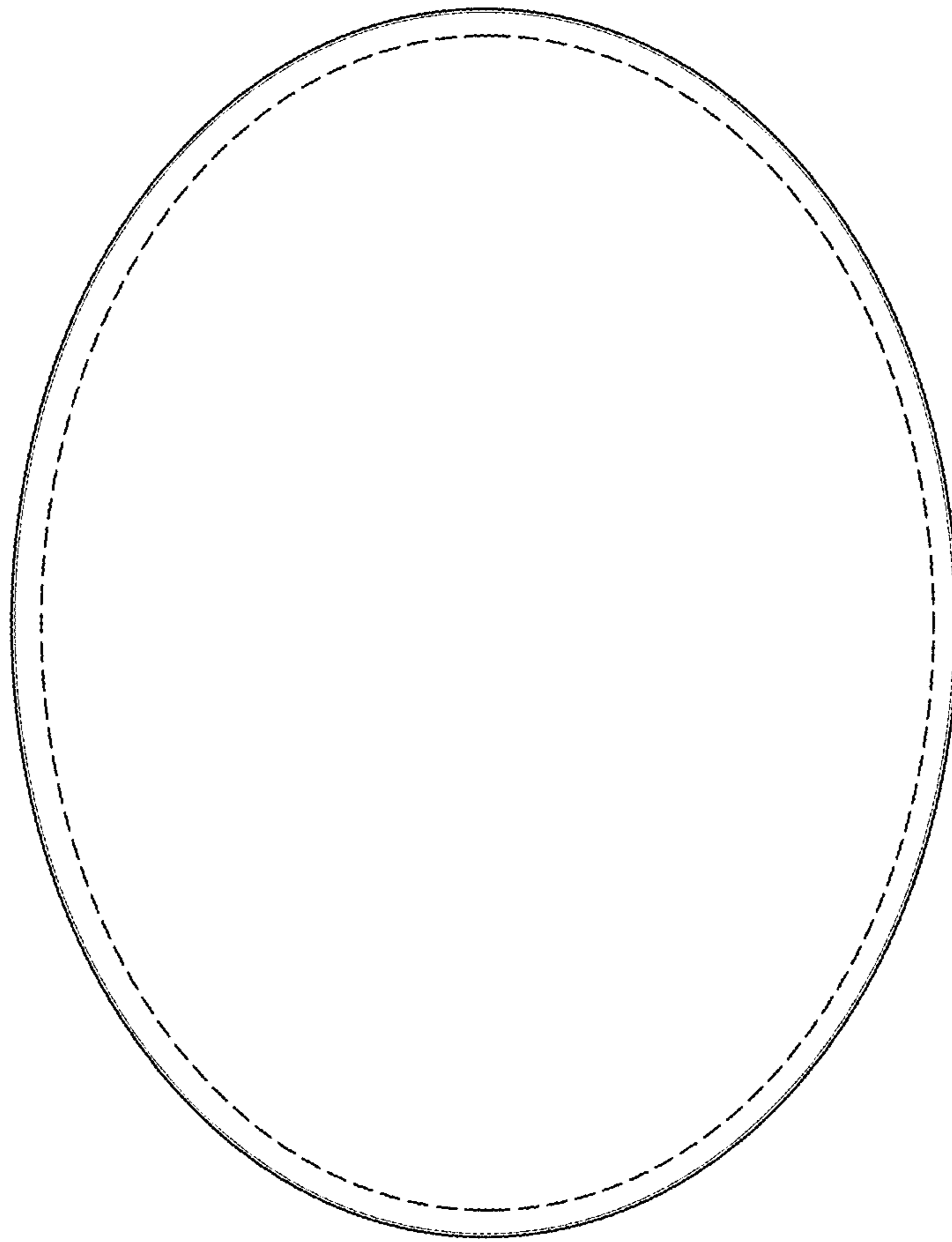
FIG. 1 is a top elevational view of my new design;  
FIG. 2 is a bottom elevational view of my new design;  
FIG. 3 is a front elevational view of my new design;  
FIG. 4 is a rear elevational view of my new design;  
FIG. 5 is a left side elevational view of my new design, the right side being identical;  
FIG. 6 is a rear right perspective view of my new design; and,  
FIG. 7 is a front right perspective view of my new design. The broken lines shown in the figures represent portions of the spongy soap dispense that form no part of the claimed design.

**1 Claim, 7 Drawing Sheets**

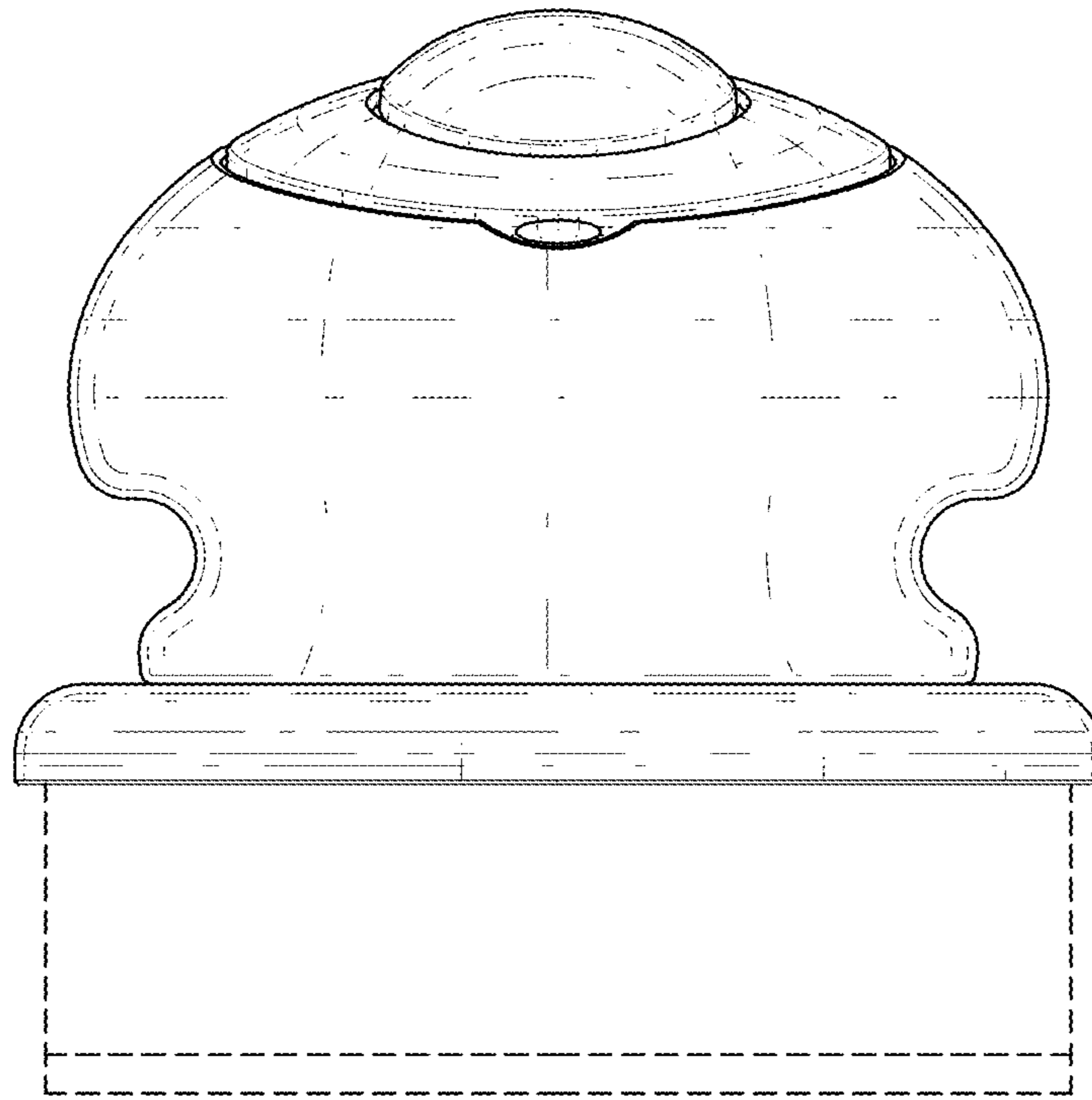




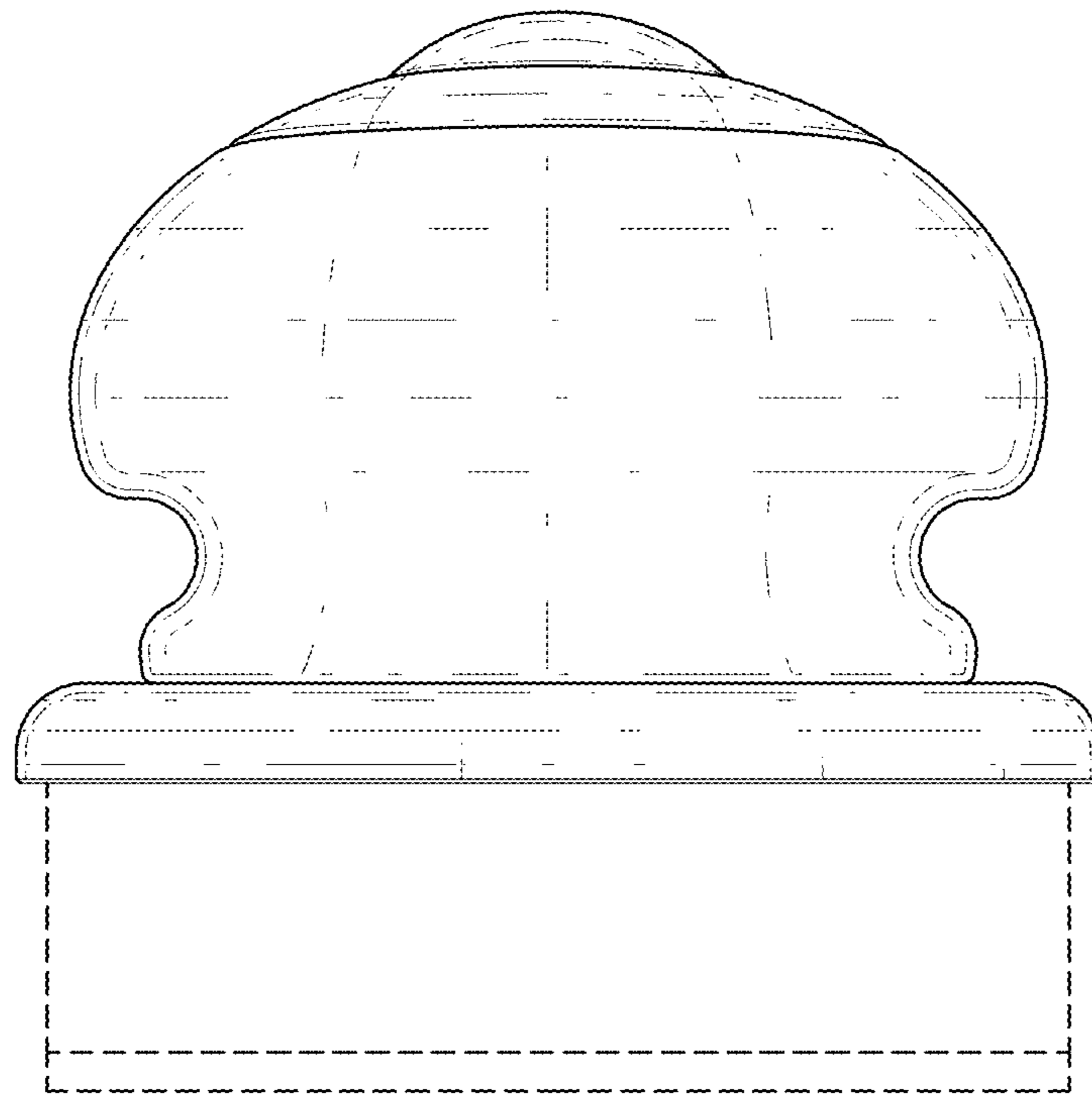
*FIG. 1*



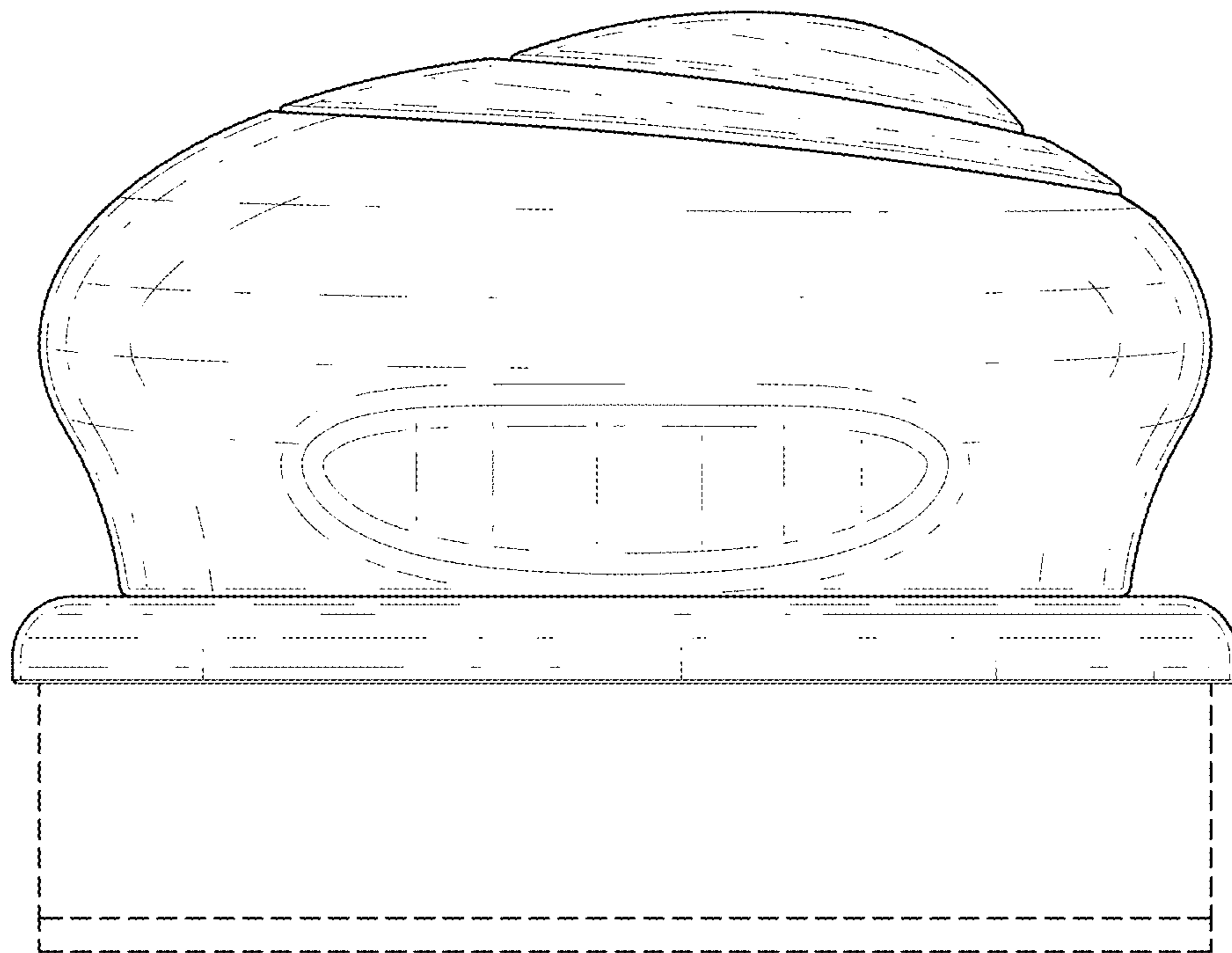
*FIG. 2*



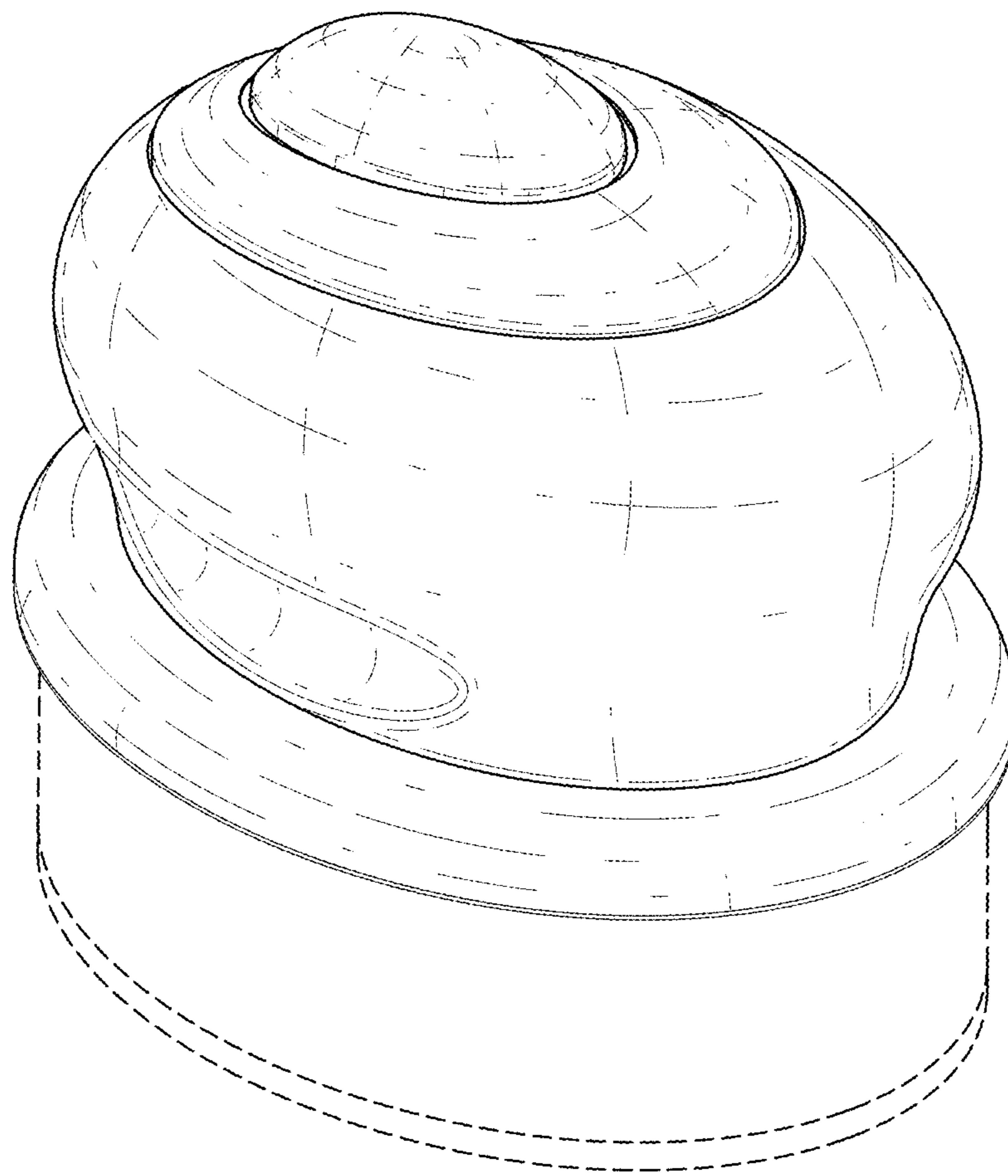
*FIG. 3*



*FIG. 4*



*FIG. 5*



*FIG. 6*

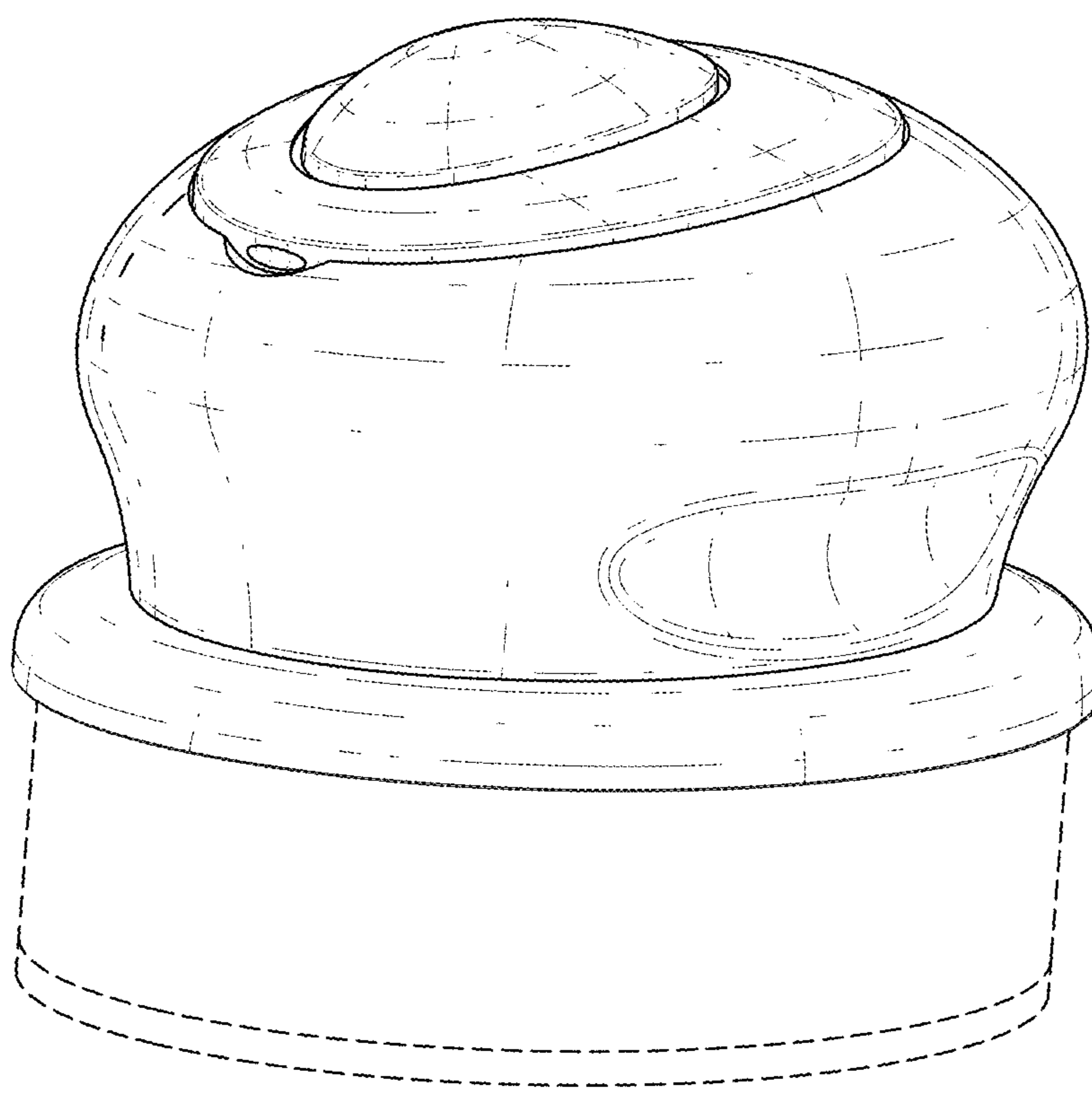


FIG. 7