

US00D817022S

(12) **United States Design Patent**
Sammut

(10) **Patent No.:** **US D817,022 S**

(45) **Date of Patent:** **** May 8, 2018**

(54) **WEAPONS STORAGE COMPONENT**

RE44,568 E 11/2013 Stepp
8,678,206 B2 3/2014 Kubinieć
9,622,577 B2 4/2017 Wirthlin et al.

(71) Applicant: **DASCO Storage Solutions Ltd.,**
Brampton (CA)

(Continued)

(72) Inventor: **Paul Sammut, Oakville, CA (US)**

OTHER PUBLICATIONS

(73) Assignee: **DASCO STORAGE SOLUTIONS LTD.,** Brampton (CA)

Toolflex Original System, <<http://www.toolflex.com/original/en/home/>>, accessed Apr. 21, 2017.

(Continued)

(**) Term: **15 Years**

Primary Examiner — Wan Laymon

Assistant Examiner — Mark Booker

(21) Appl. No.: **29/592,650**

(74) *Attorney, Agent, or Firm* — Bereskin & Parr
LLP/S.E.N.C.R.L., s.r.l.

(22) Filed: **Feb. 1, 2017**

(51) **LOC (11) Cl.** **08-08**

(57) **CLAIM**

The ornamental design for a weapons storage component, as shown and described.

(52) **U.S. Cl.**

USPC **D6/522**

DESCRIPTION

(58) **Field of Classification Search**

USPC D6/552; D22/109, 110; 42/99;
211/13.1, 60.1, 64; 248/65, 206.5, 309.4,
248/467, 537, 683

CPC F41A 23/18; B60R 7/14

See application file for complete search history.

FIG. 1 is a front, top, left side perspective view of a weapons storage component;

FIG. 2 is a back, bottom, right side perspective view of the weapons storage component of FIG. 1;

FIG. 3 is a left side view of the weapons storage component of FIG. 1;

FIG. 4 is a front view of the weapons storage component of FIG. 1;

FIG. 5 is a right side view of the weapons storage component of FIG. 1;

FIG. 6 is a back view of the weapons storage component of FIG. 1;

FIG. 7 is a top view of the weapons storage component of FIG. 1; and,

FIG. 8 is a bottom view of the weapons storage component of FIG. 1.

The broken lines in the drawings are portions of the weapons storage component that form no part of the claimed design.

(56) **References Cited**

U.S. PATENT DOCUMENTS

3,315,816 A	4/1967	Mallory	
D457,369 S *	5/2002	Fiscus	D6/552
D468,555 S	1/2003	Romaen et al.	
D472,091 S *	3/2003	Bell	D6/552
6,679,379 B1	1/2004	Kao	
6,866,154 B2	3/2005	Hartman et al.	
D559,346 S	1/2008	Early, IV	
7,467,719 B2	12/2008	Crowell et al.	
D587,051 S *	2/2009	Vining	D6/552
D609,080 S *	2/2010	Schorn	D6/552
7,857,149 B2	12/2010	Cummins	
7,963,406 B2	6/2011	Kinsella	
D668,310 S	10/2012	Verheyen	

1 Claim, 8 Drawing Sheets

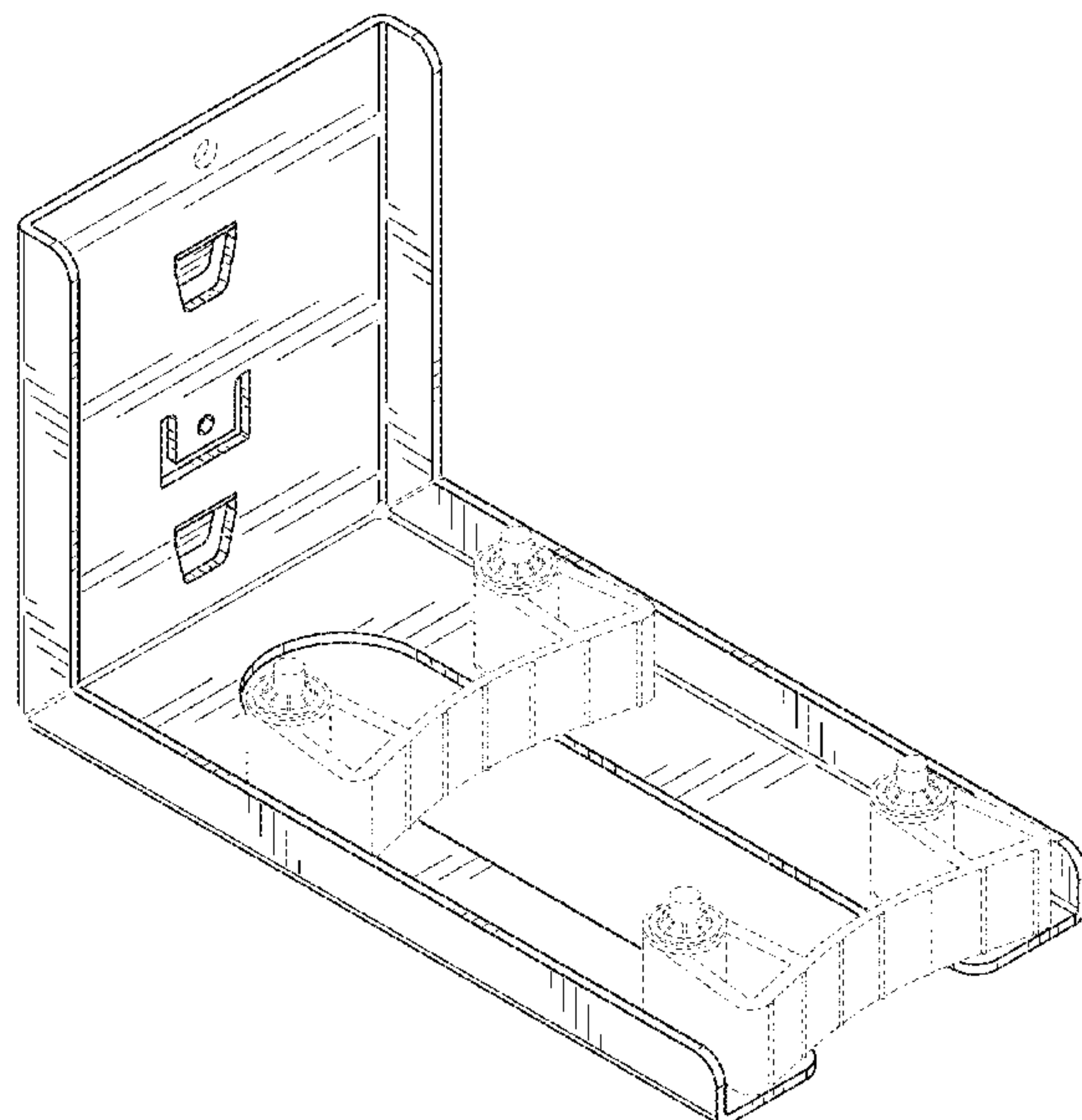

(56)

References Cited

U.S. PATENT DOCUMENTS

2012/0193254 A1* 8/2012 Kubiniec A47B 81/005
206/317

OTHER PUBLICATIONS

Toolflex Original System, <<http://www.toolflex.com/original/en/products/>>, accessed Apr. 21, 2017.

* cited by examiner

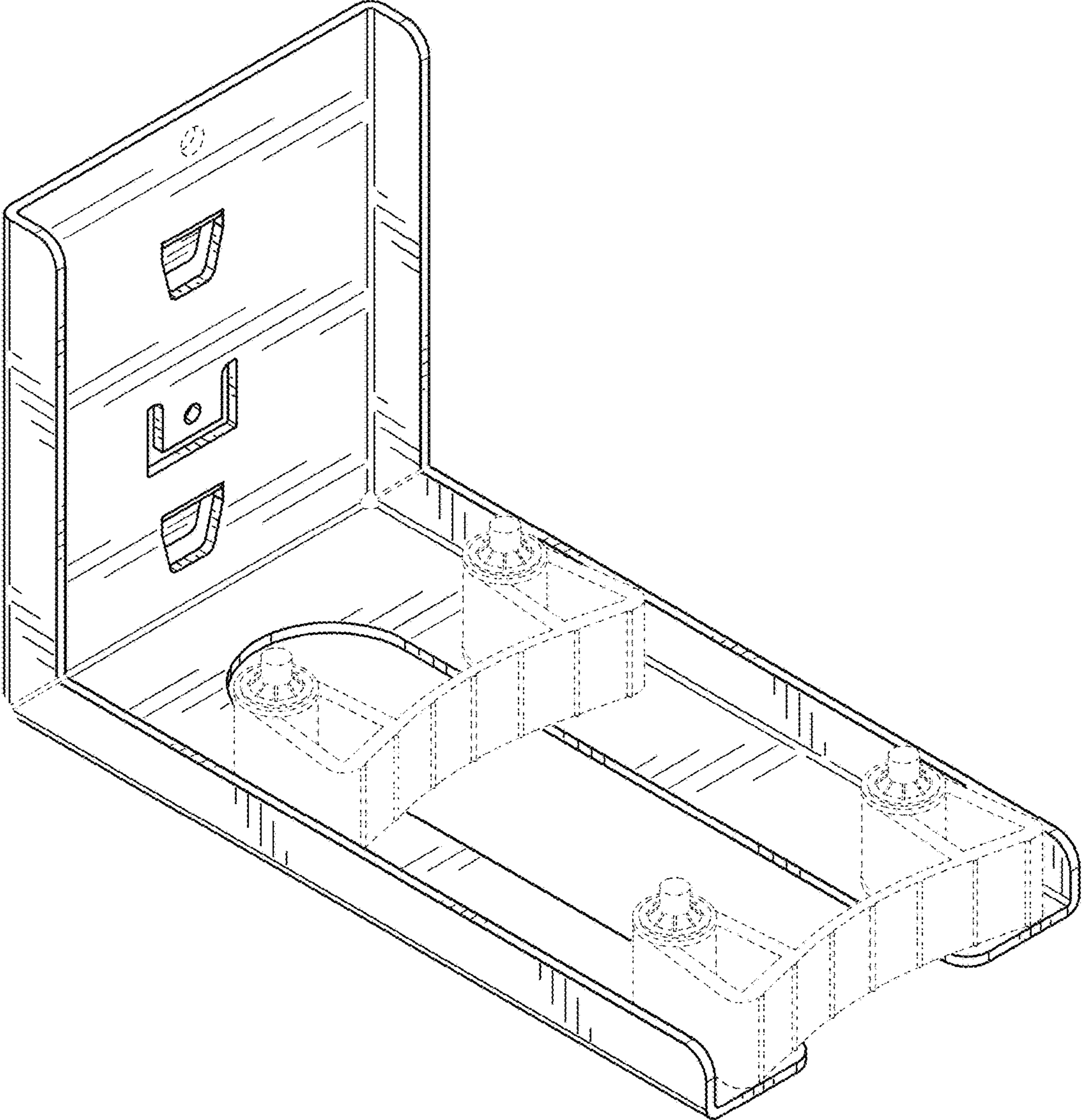

FIG. 1

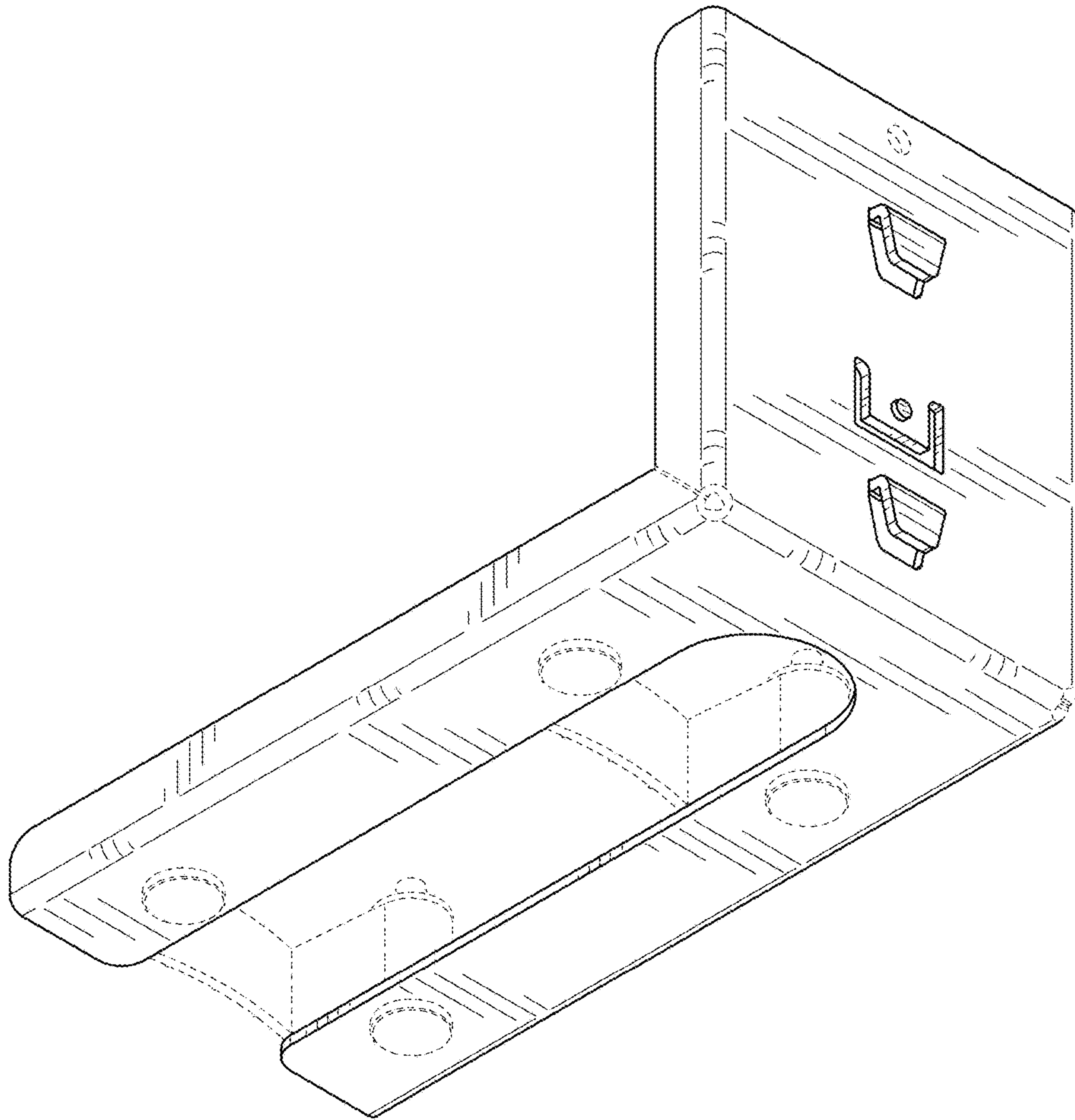

FIG. 2

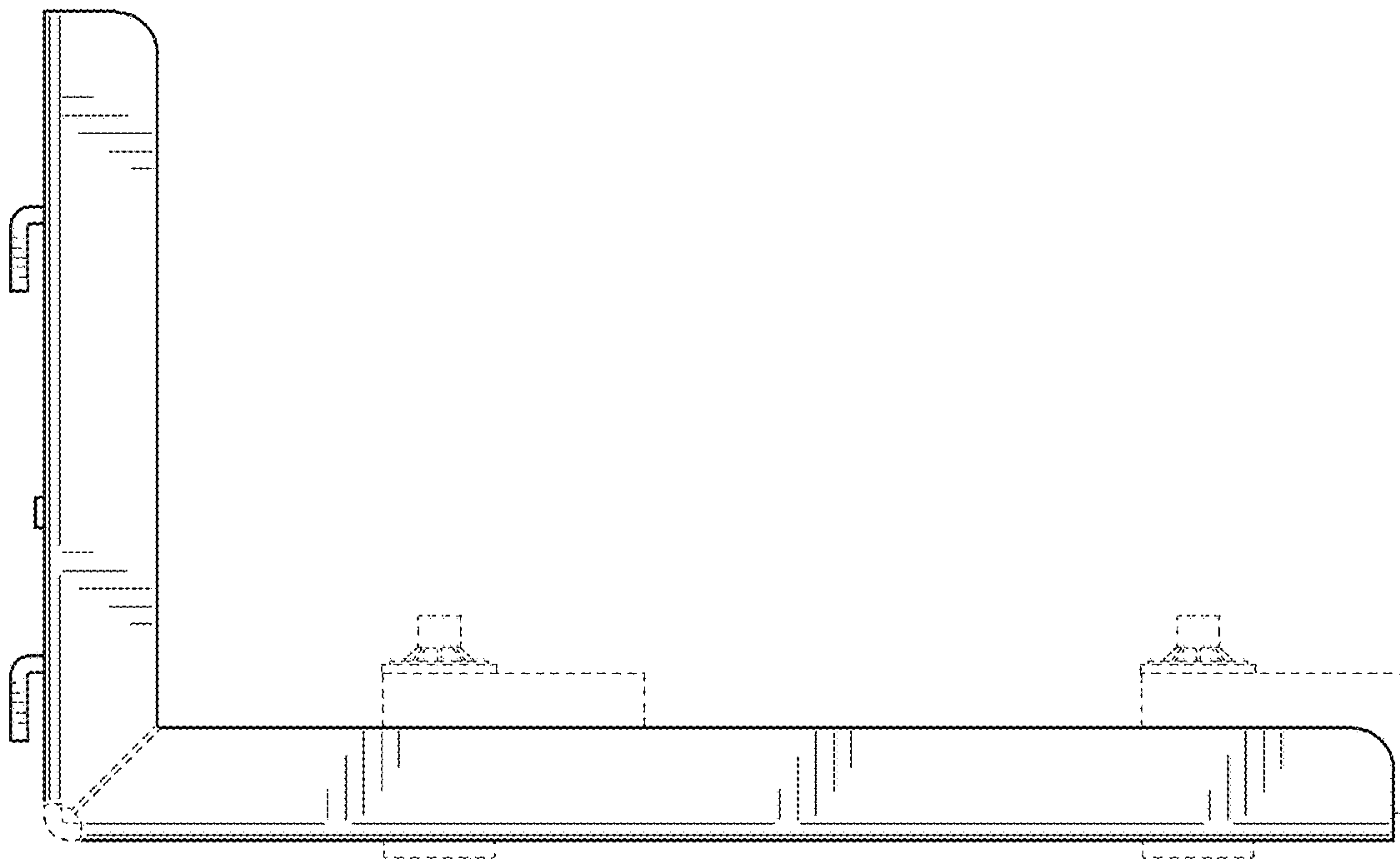

FIG. 3

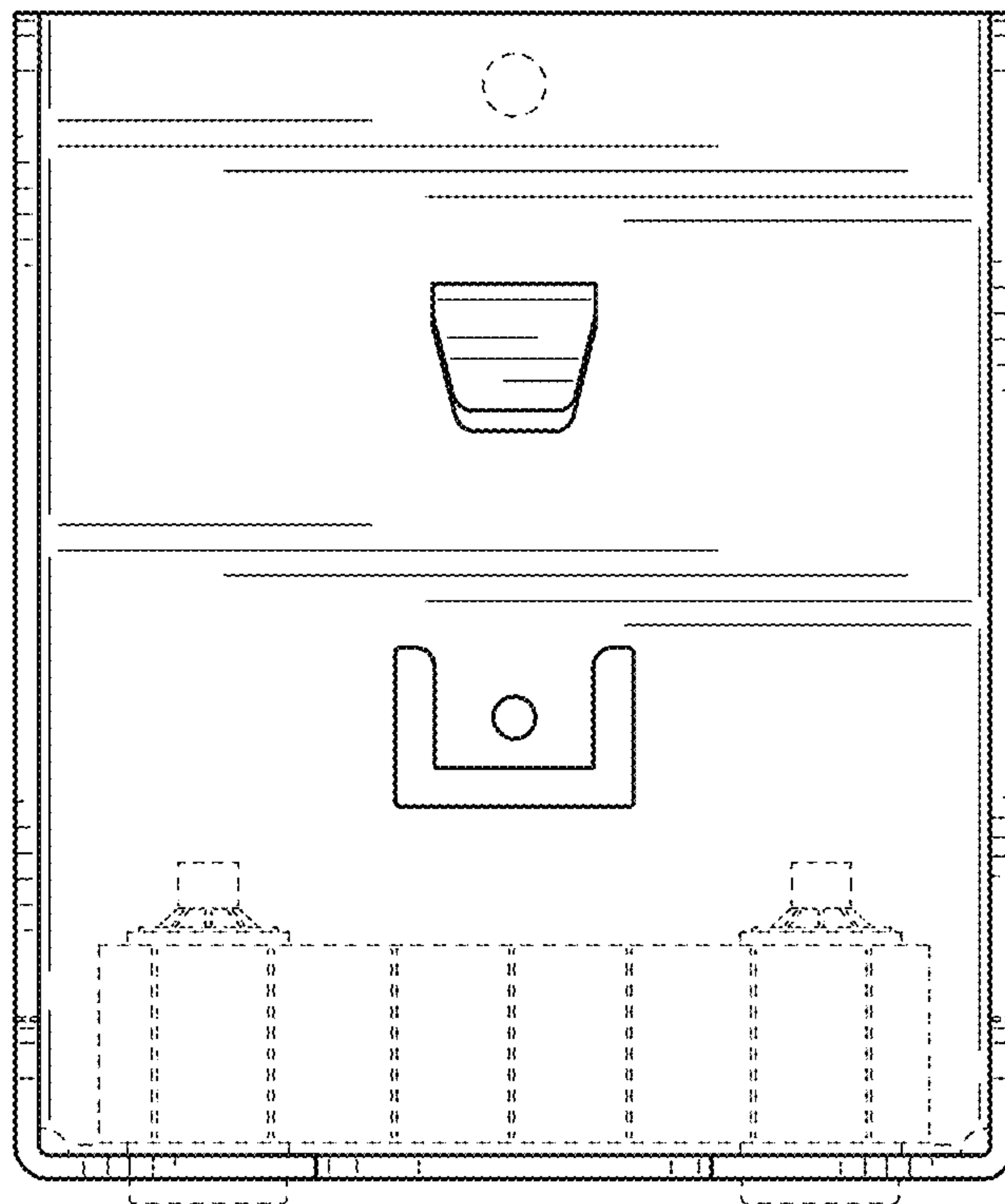

FIG. 4

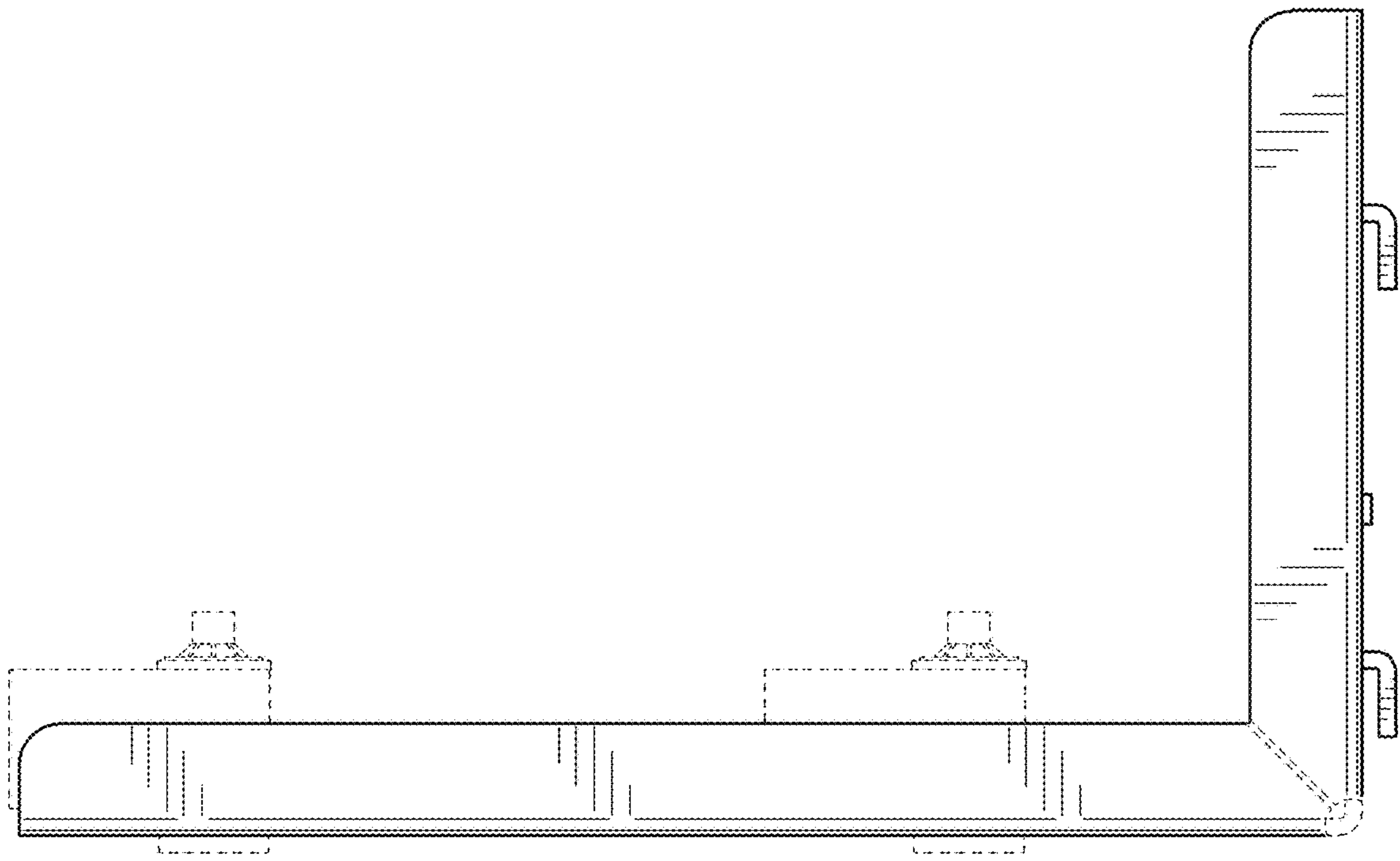

FIG. 5

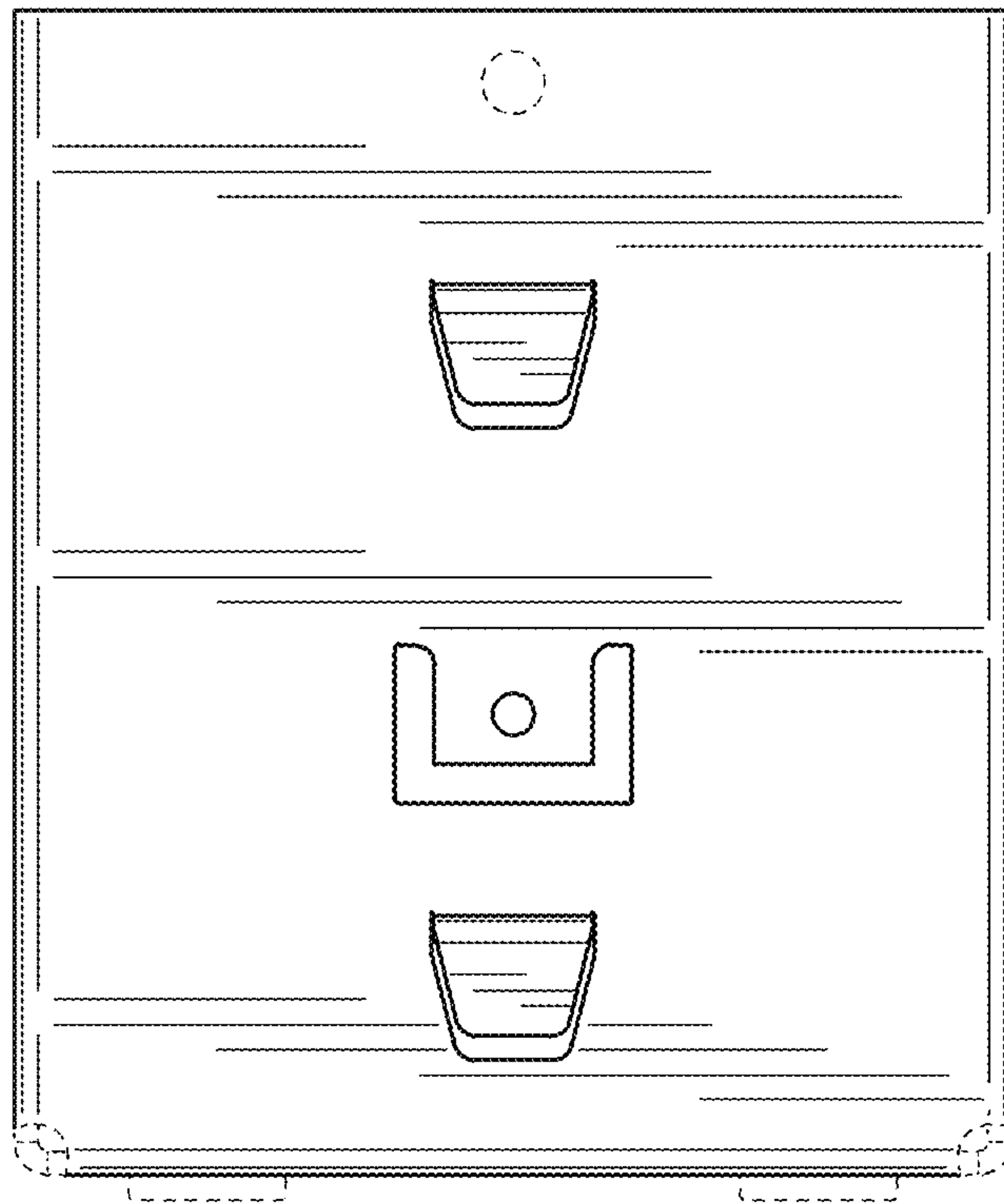

FIG. 6

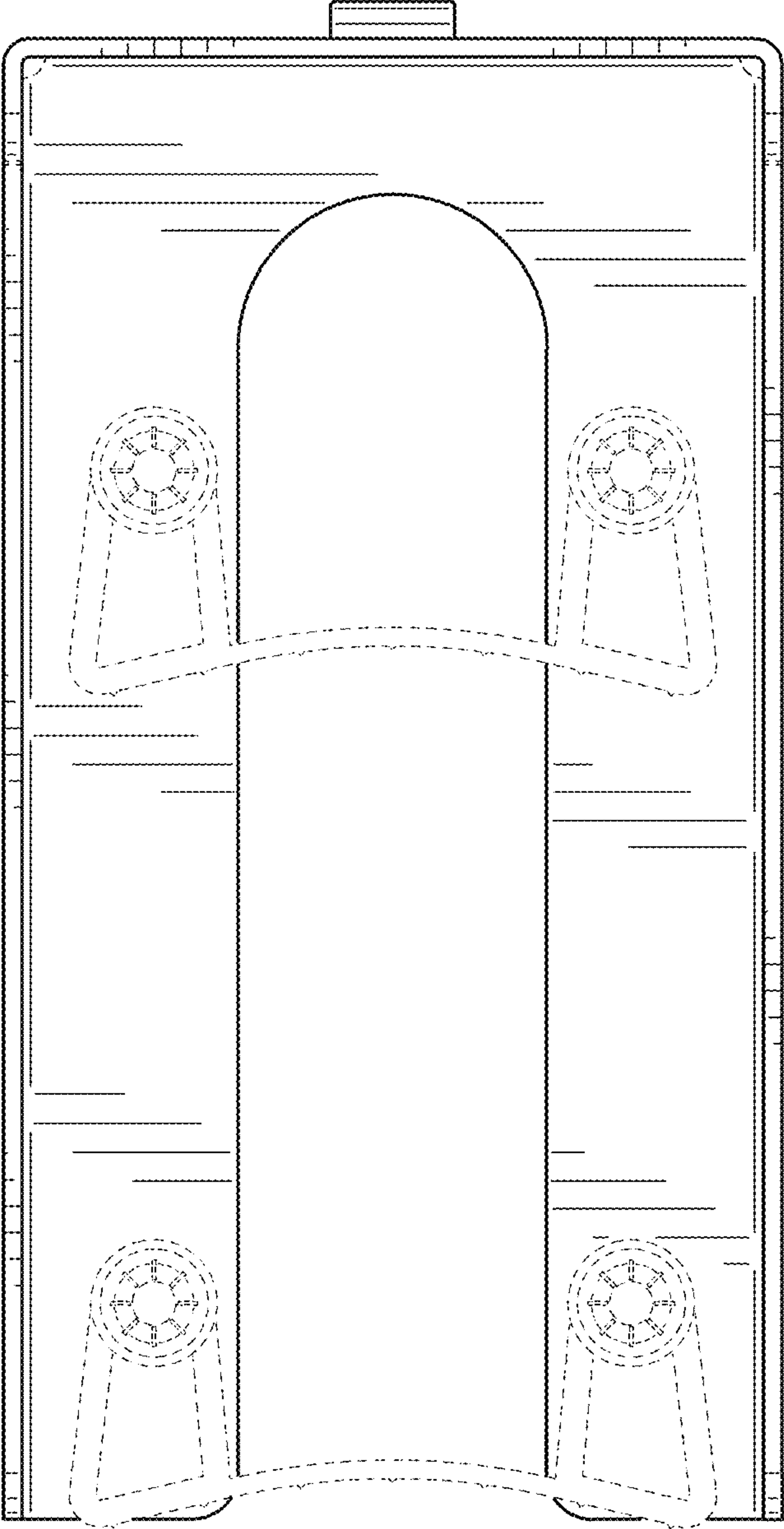

FIG. 7

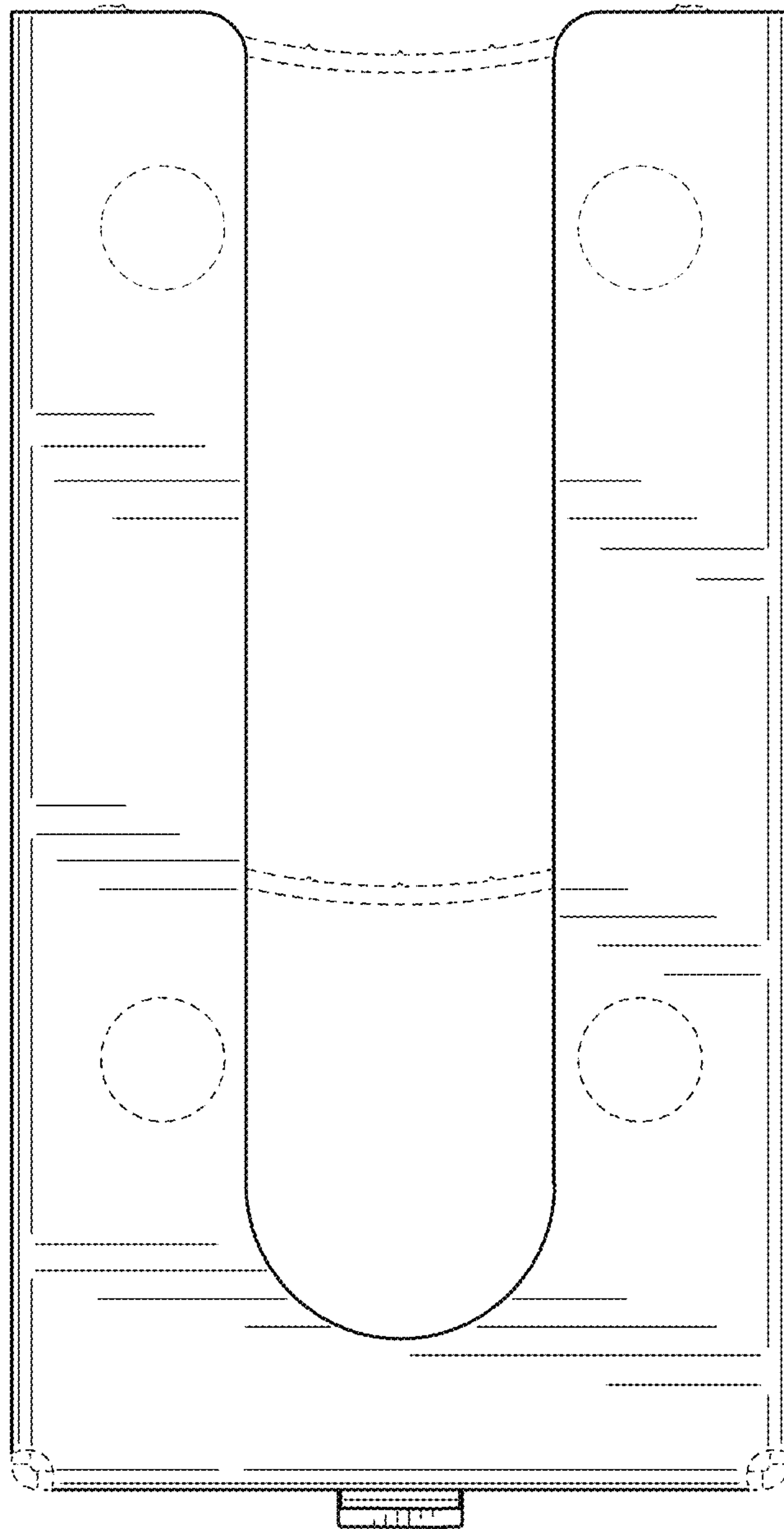

FIG. 8