



US00D817014S

(12) **United States Design Patent** (10) **Patent No.:** **US D817,014 S**
Zhu (45) **Date of Patent:** **** May 8, 2018**

- (54) **FOLDABLE CHAIR WITH CHANGEABLE SEATS**
- (71) Applicant: **Shou Qiang Zhu**, Ontario, CA (US)
- (72) Inventor: **Shou Qiang Zhu**, Ontario, CA (US)
- (73) Assignee: **Maxton Engineering Ltd.**, Hong Kong (HK)
- (**) Term: **15 Years**
- (21) Appl. No.: **29/539,417**
- (22) Filed: **Sep. 14, 2015**
- (51) **LOC (11) Cl.** **06-01**
- (52) **U.S. Cl.**
USPC **D6/368**
- (58) **Field of Classification Search**
USPC D6/334-336, 368, 371-373, 374, 375,
D6/716, 716.1, 716.2, 716.4
CPC .. A47C 4/03; A47C 4/28; A47C 4/283; A47C
4/30; A47C 4/40; A47C 4/42; A47C 4/48;
A47C 5/06; A47C 5/10
See application file for complete search history.

(56) **References Cited**

U.S. PATENT DOCUMENTS

- 5,499,857 A * 3/1996 Lynch, Jr. A47C 4/286
D6/368
- D432,325 S * 10/2000 Zheng D6/368
- 6,247,748 B1 * 6/2001 Zheng A47C 4/30
297/16.2
- D529,304 S * 10/2006 Le Gal D6/368

* cited by examiner

Primary Examiner — Mimosa De
(74) *Attorney, Agent, or Firm* — Che-Yang Chen; Law
Offices of Scott Warmuth

(57) **CLAIM**

The ornamental design for a foldable chair with changeable seats, as shown and described.

DESCRIPTION

FIG. 1 is a perspective view of the foldable chair with changeable seats showing my new design; FIG. 2 is a front elevational view thereof; FIG. 3 is a rear elevational view thereof; FIG. 4 is a left side elevational view thereof; FIG. 5 is a right side elevational thereof; FIG. 6 is a top plan view thereof; FIG. 7 is a bottom plan view thereof; FIG. 8 is an exploded view thereof; FIG. 9 is a perspective view of the foldable chair with changeable seats with a second seat showing my new design; FIG. 10 is a front elevational view thereof; FIG. 11 is a rear elevational view thereof; FIG. 12 is a left side elevational view thereof; FIG. 13 is a right side elevational thereof; FIG. 14 is a top plan view thereof; FIG. 15 is a bottom plan view thereof; FIG. 16 is an exploded view thereof; and, FIG. 17 is a perspective view of the chair structure when it is folded.

The dashed lines shown on the seat and backrest of the chair are understood to represent stitching.

1 Claim, 17 Drawing Sheets

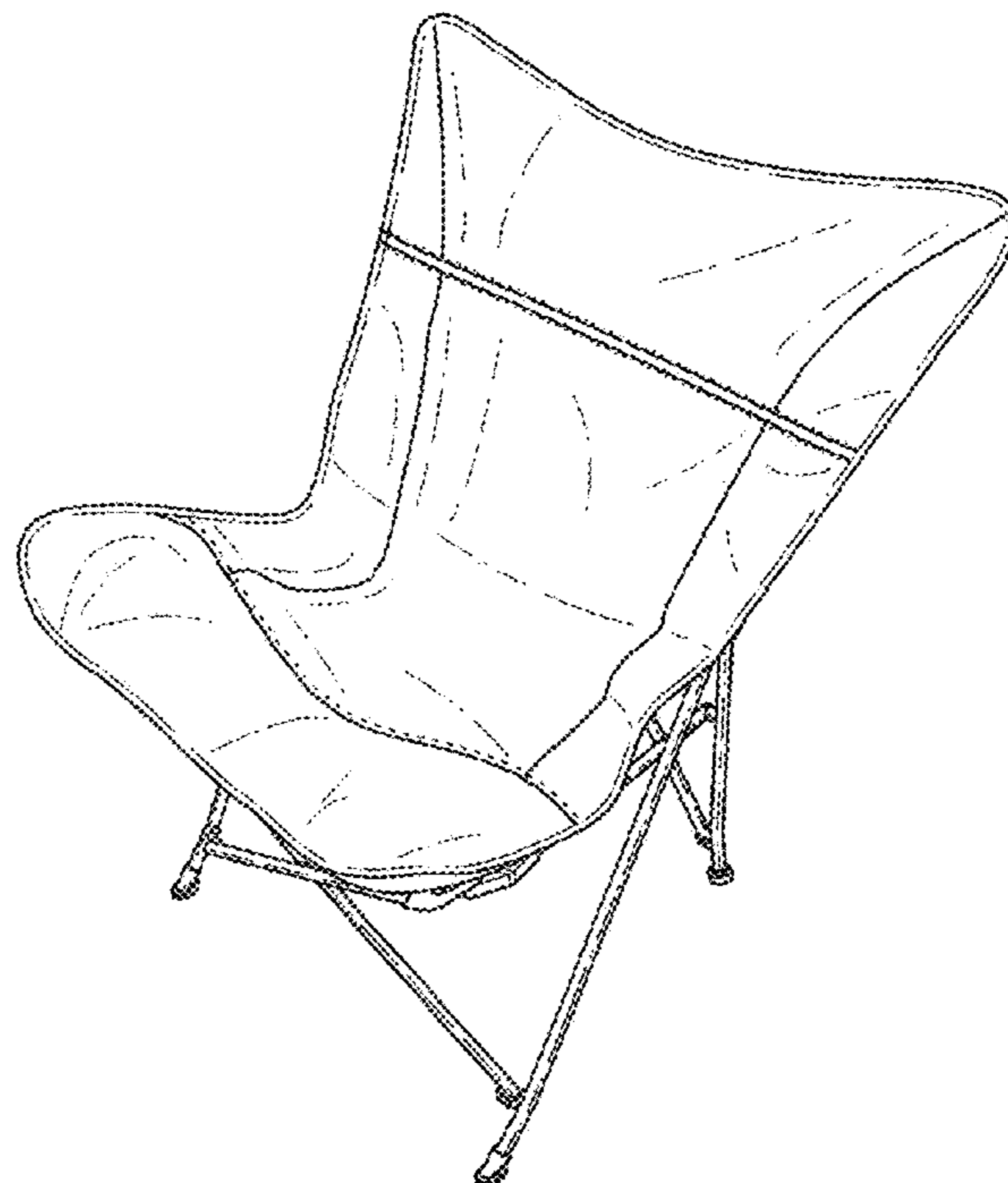



FIG. 1

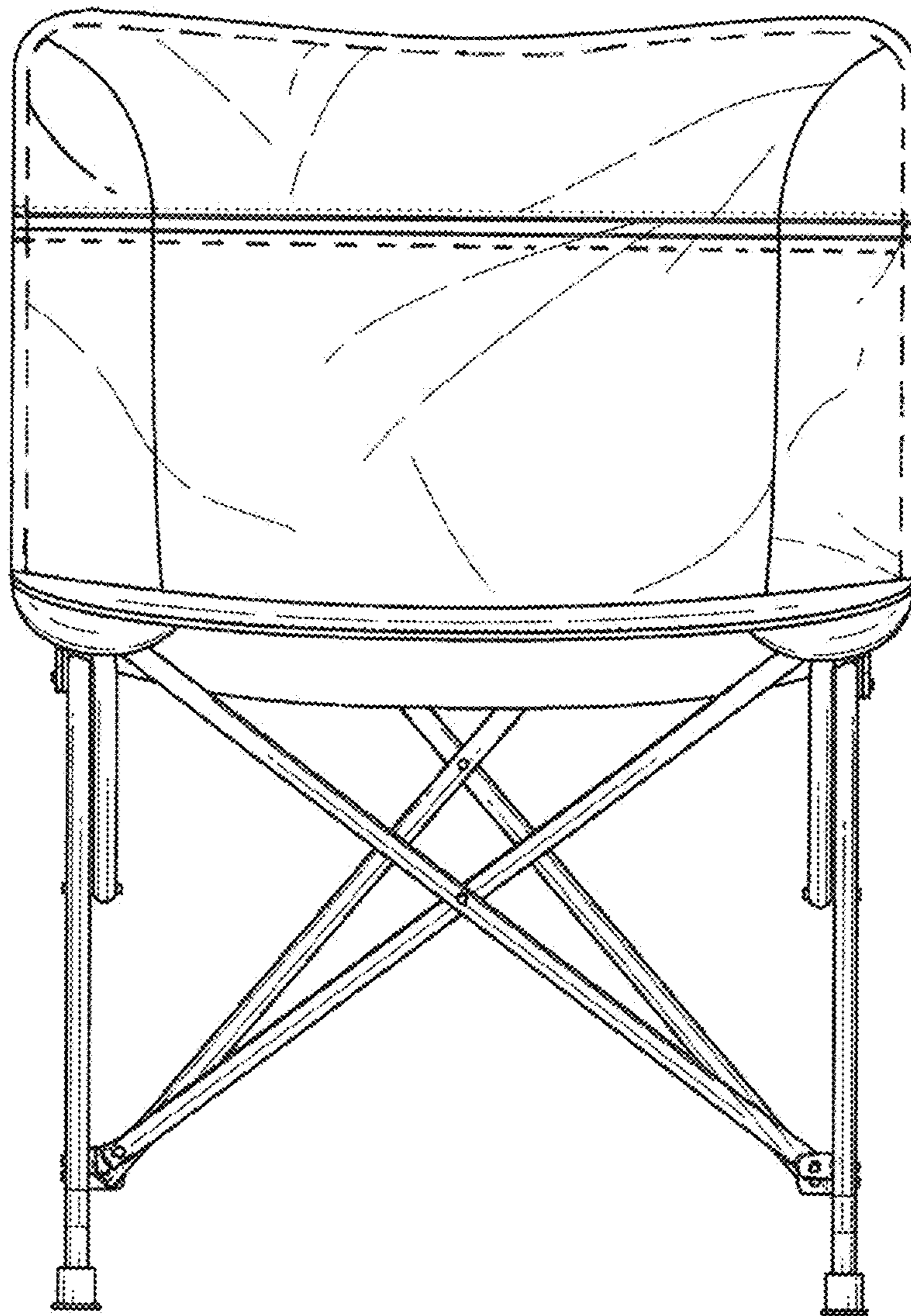

FIG. 2

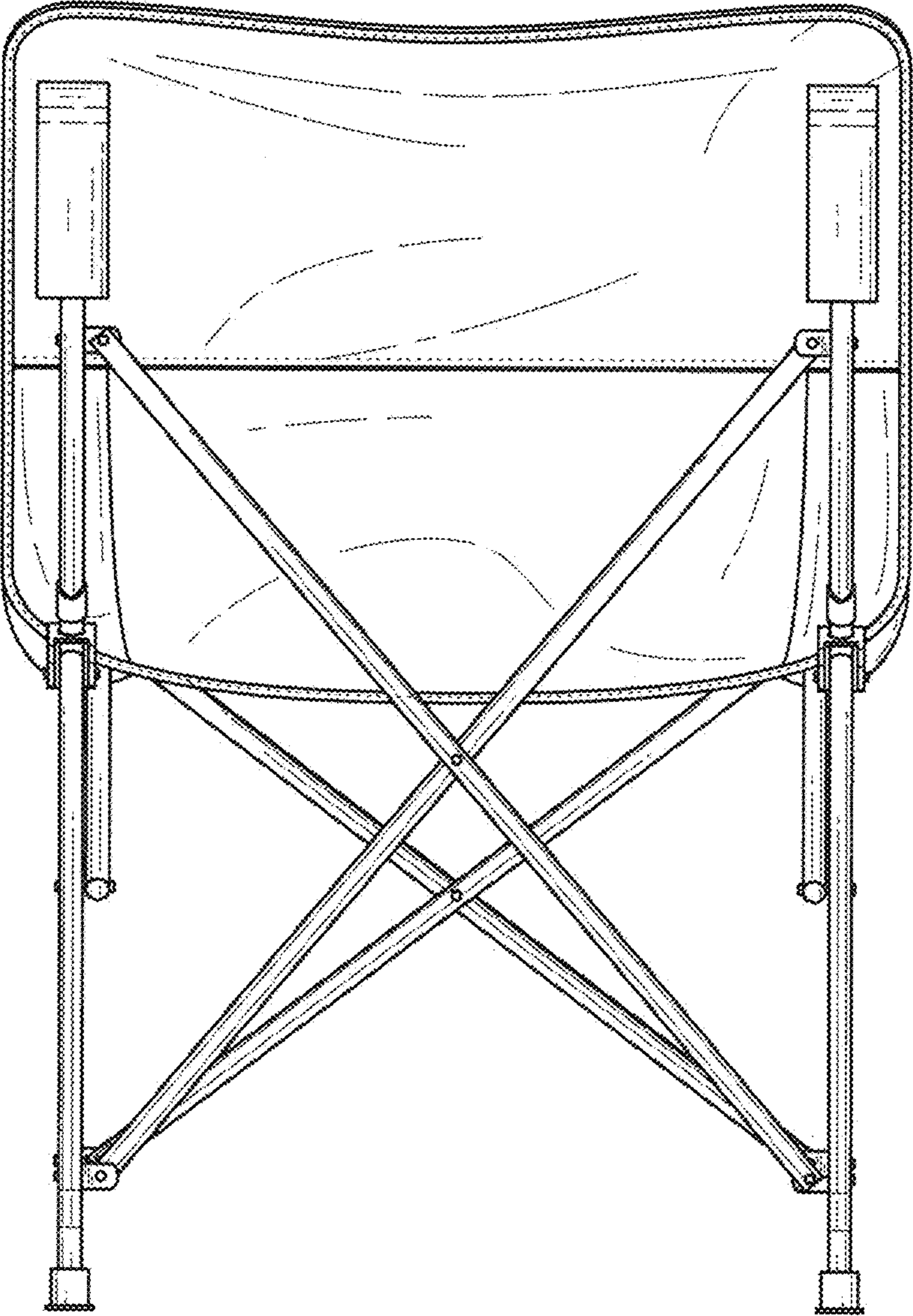

FIG. 3

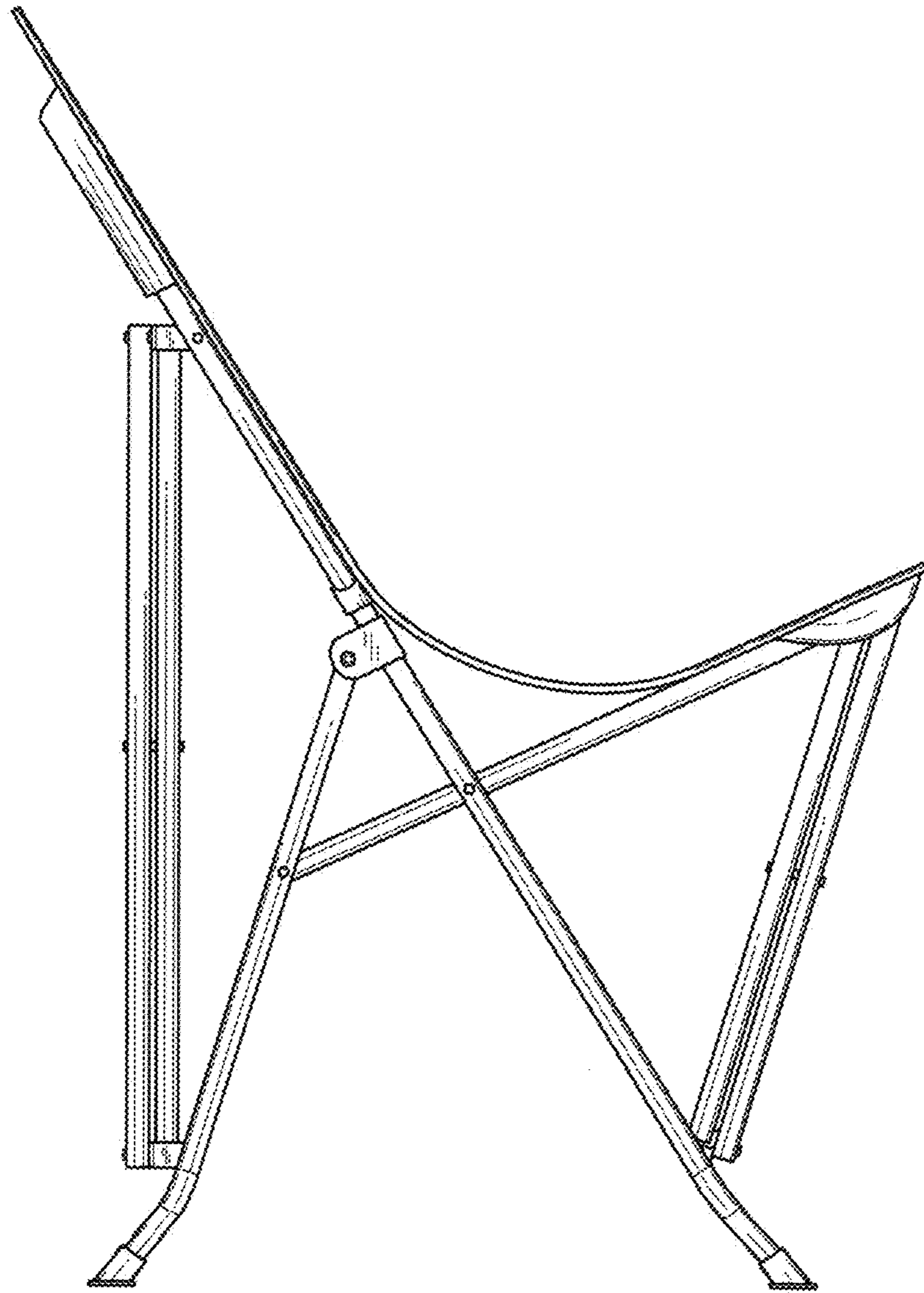

FIG. 4

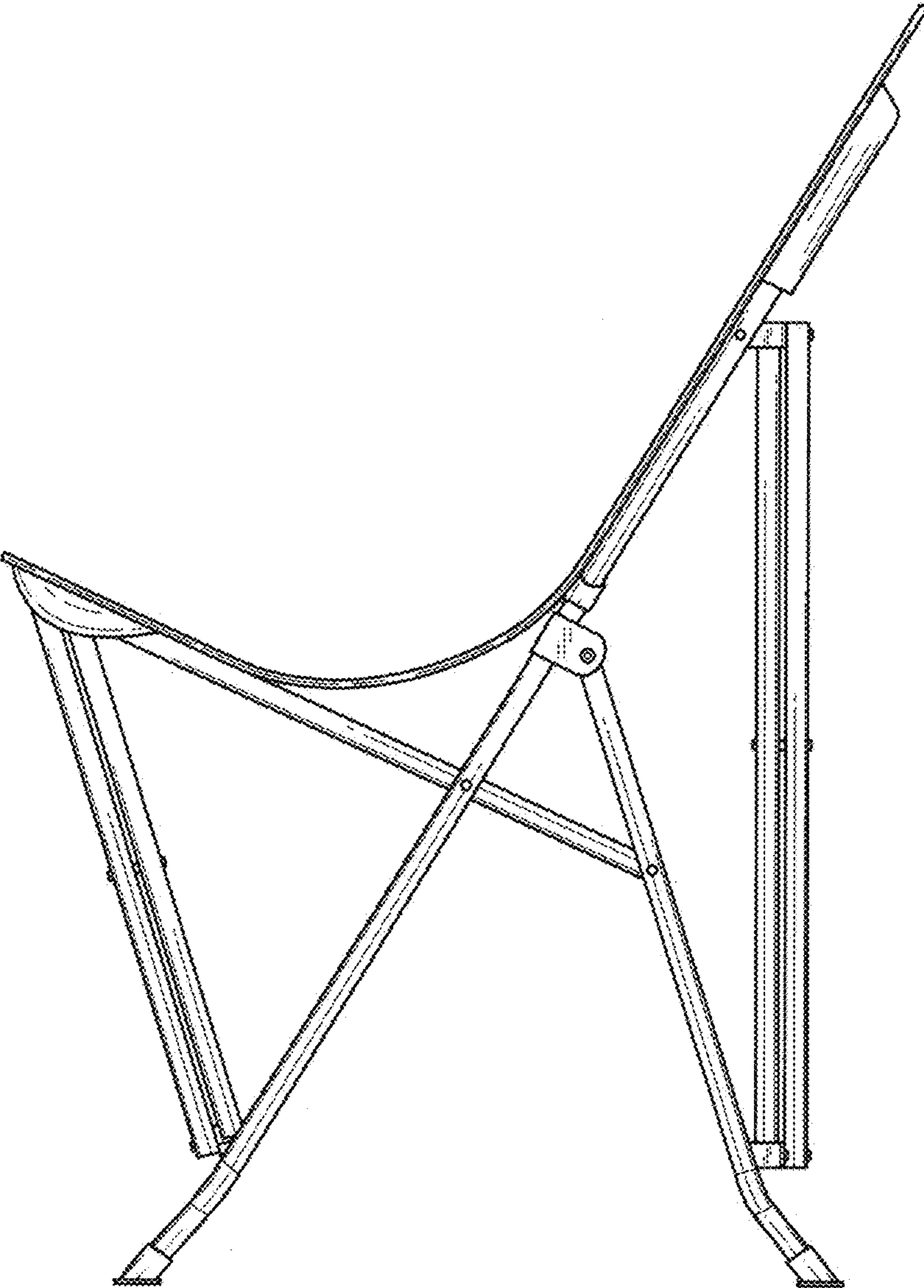

FIG. 5

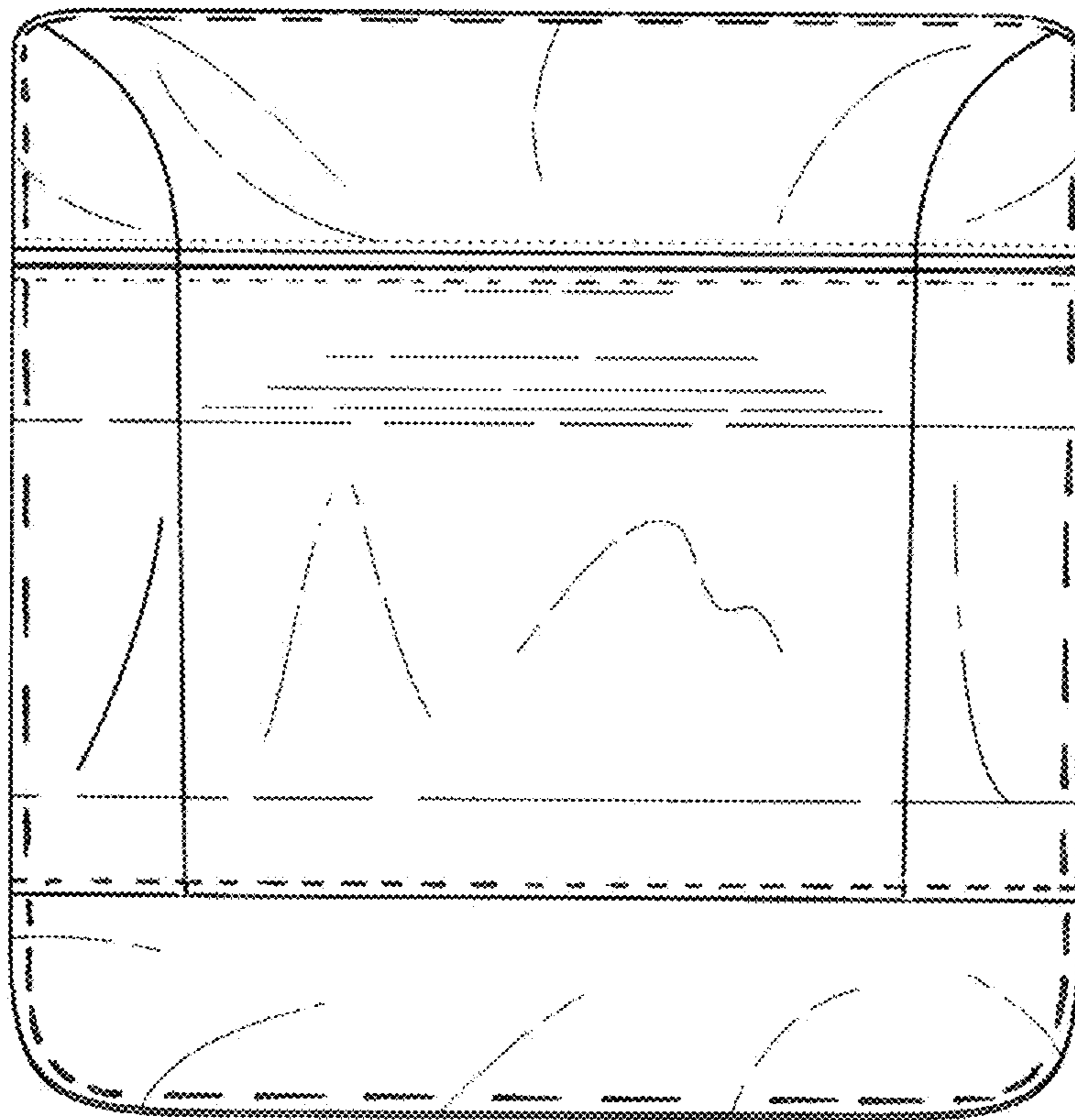

FIG. 6

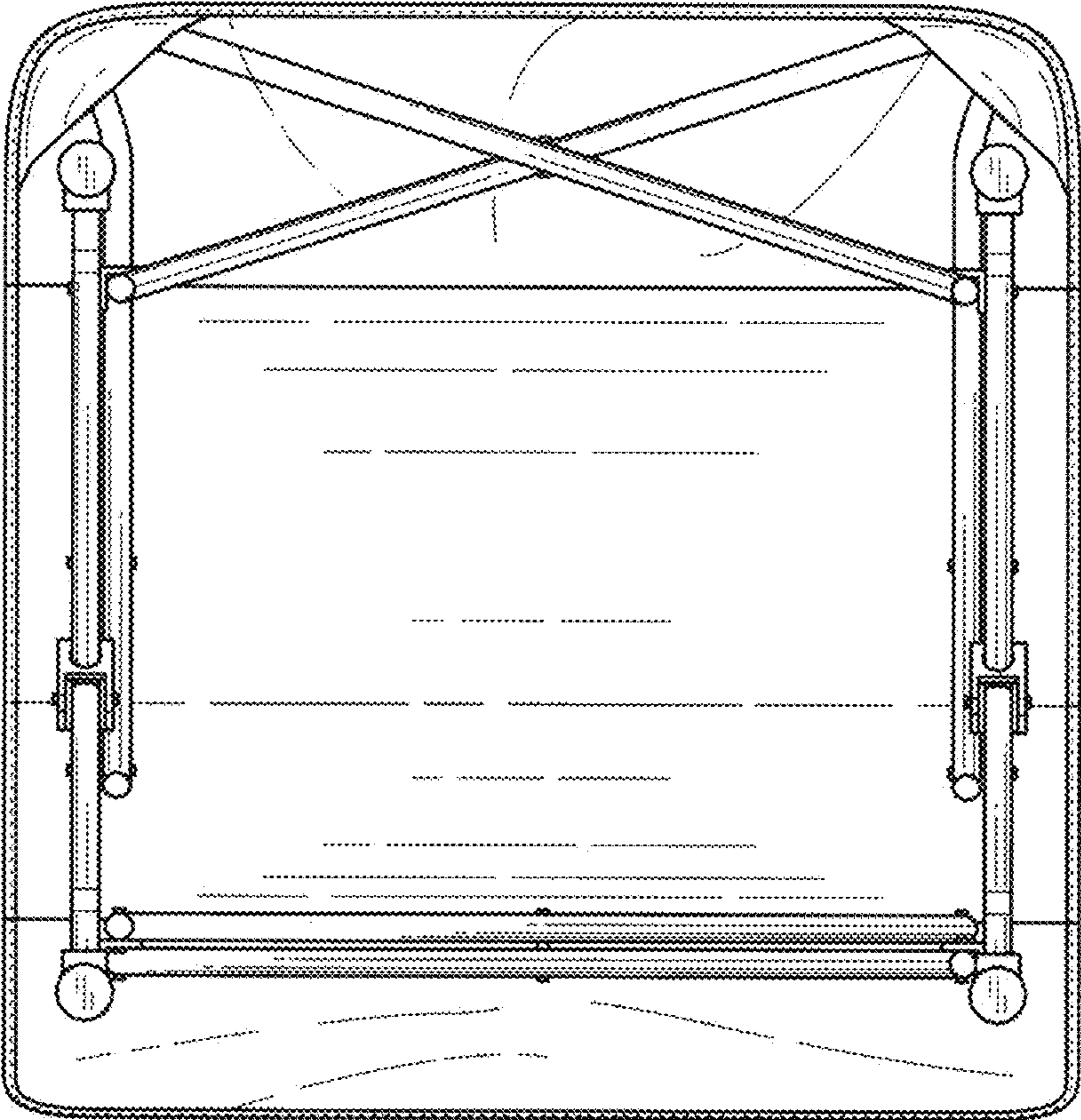

FIG. 7

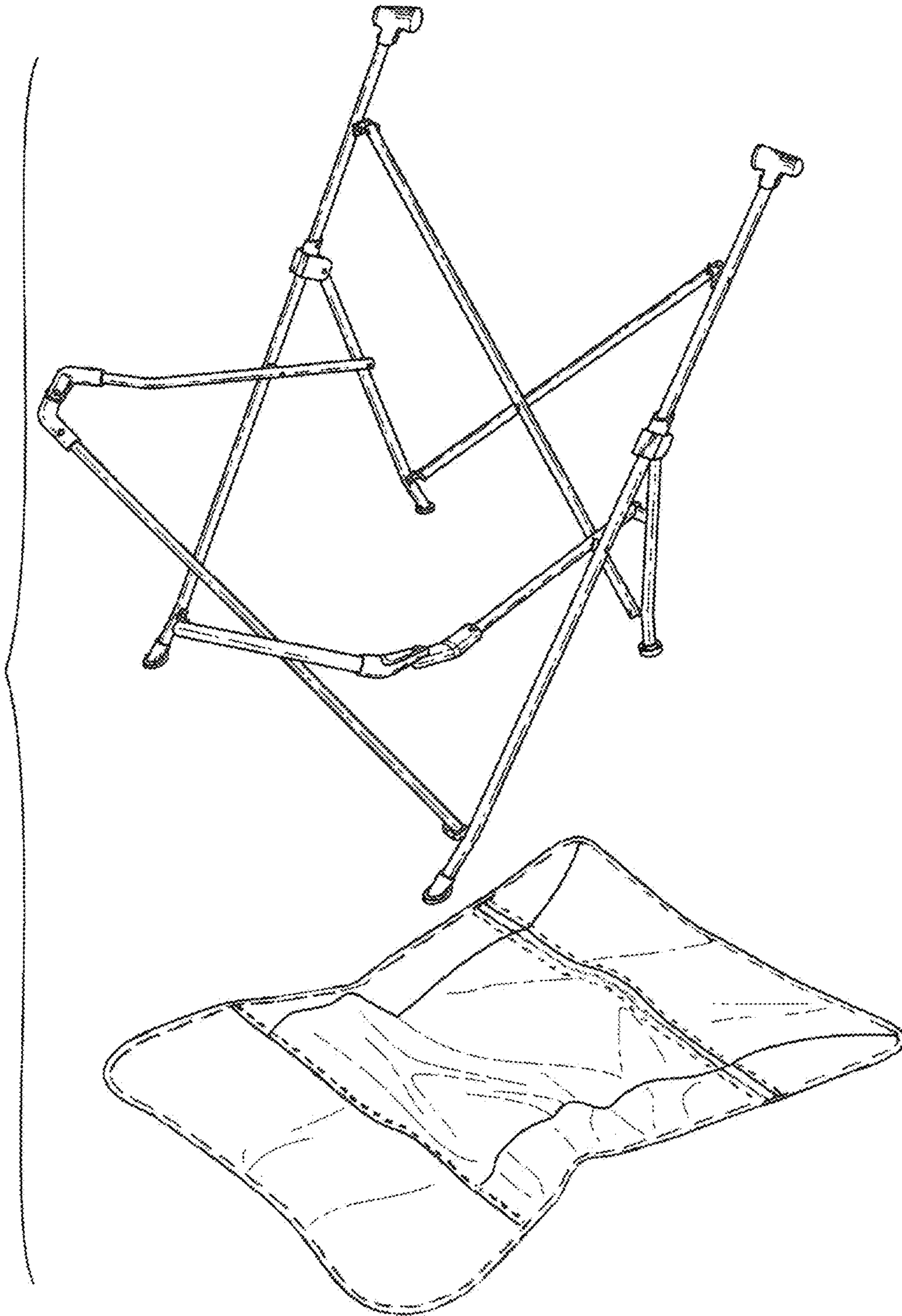

FIG. 8



FIG. 9

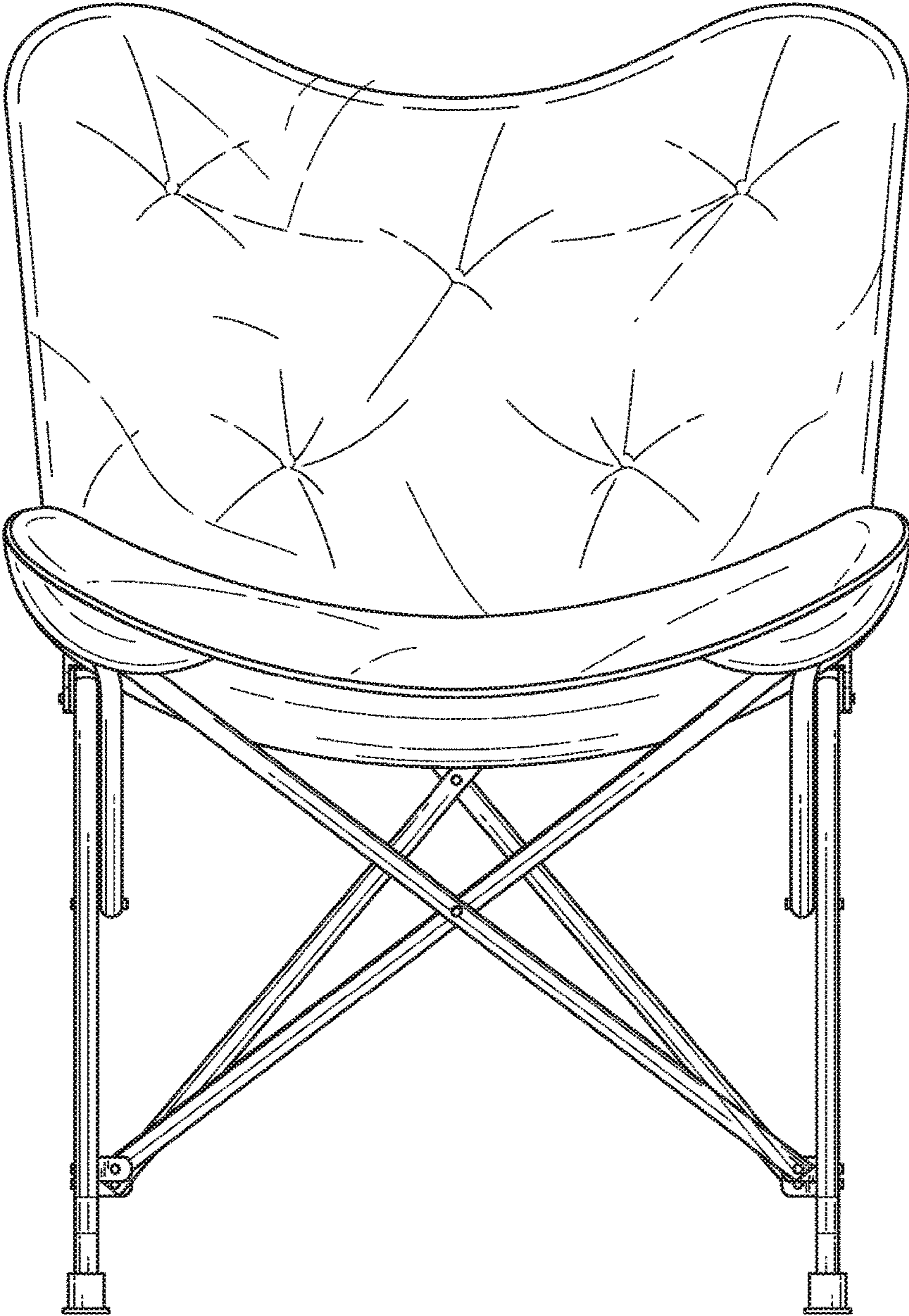

FIG. 10

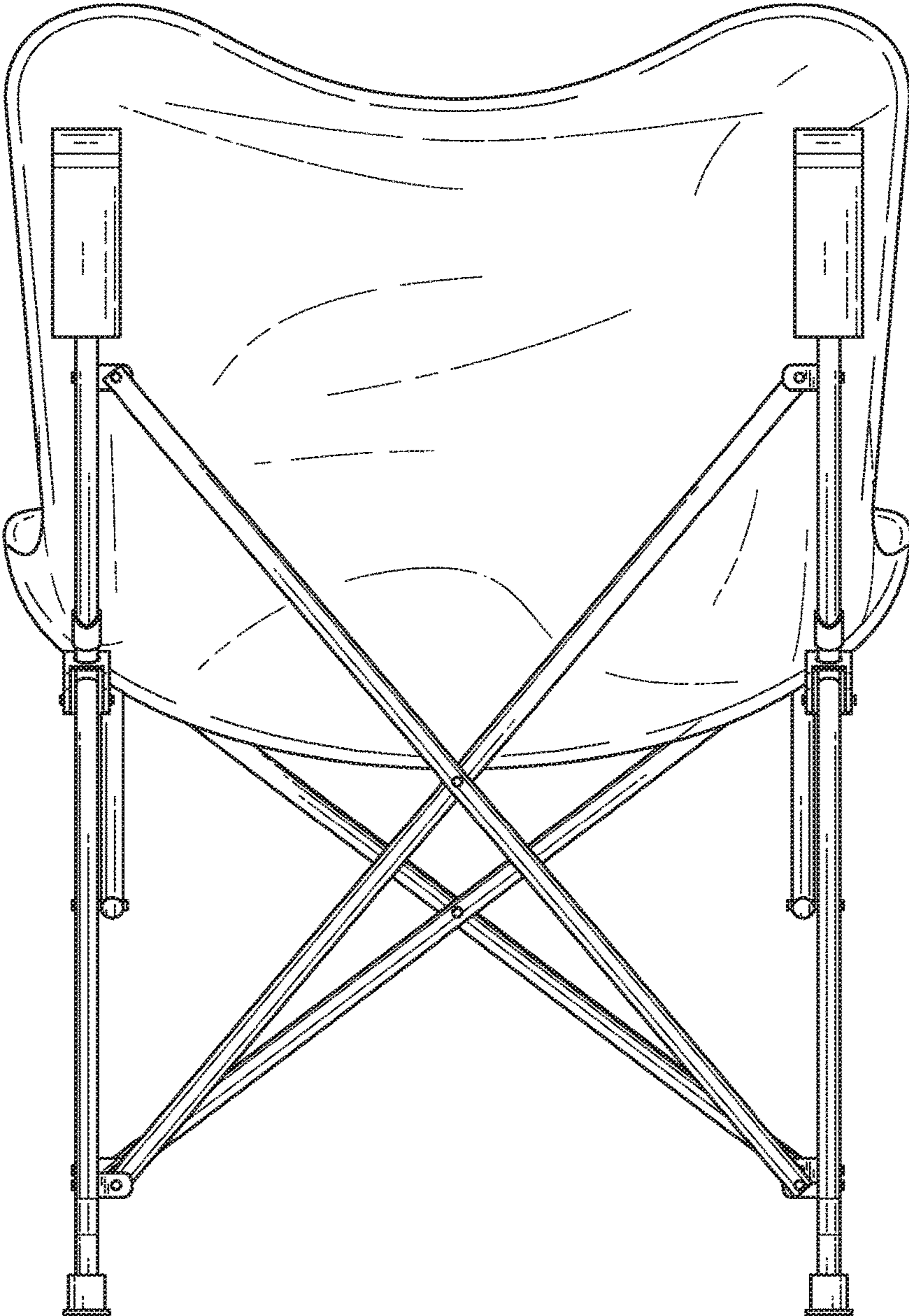

FIG. 11

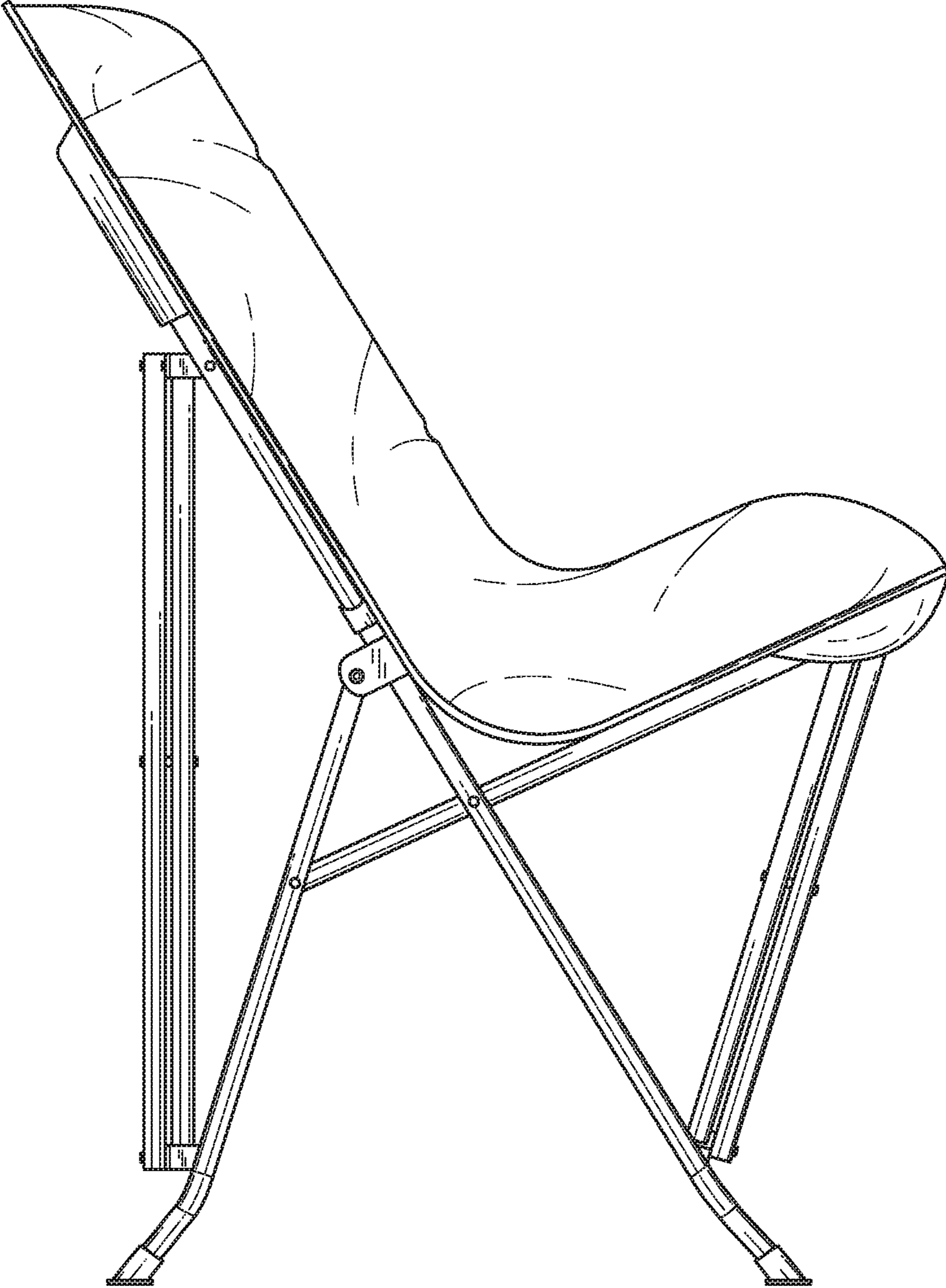

FIG. 12

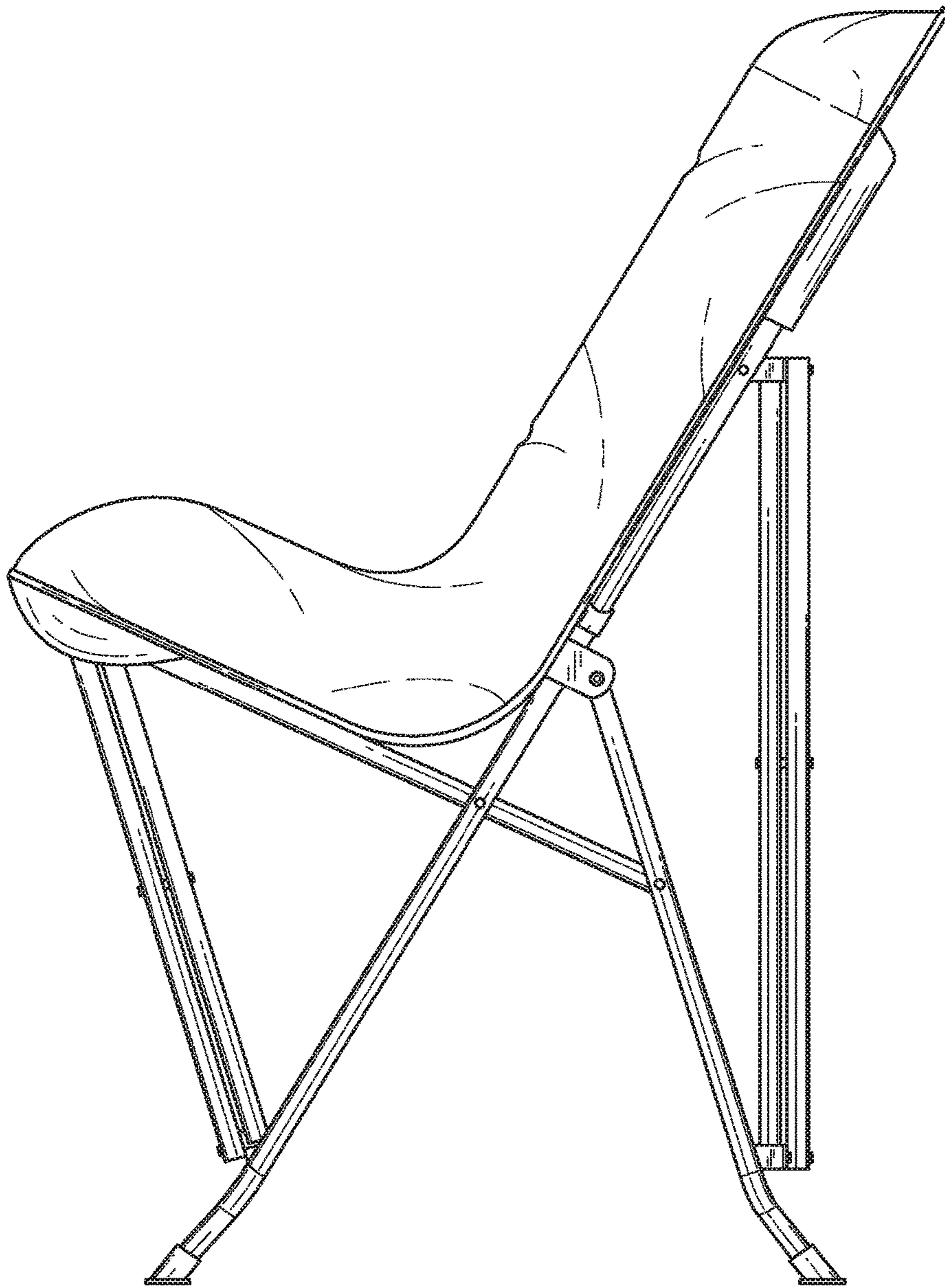

FIG. 13

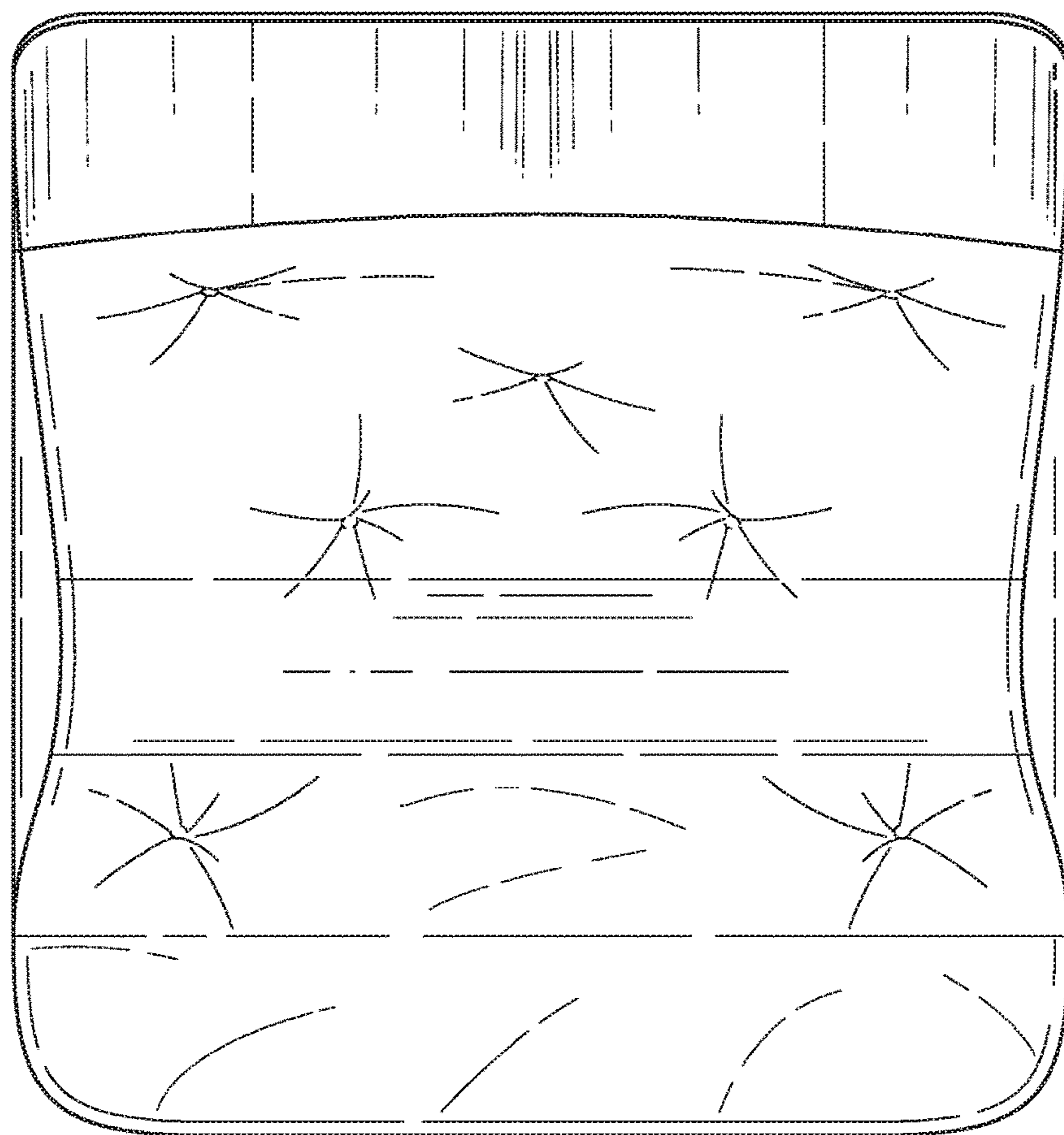

FIG. 14

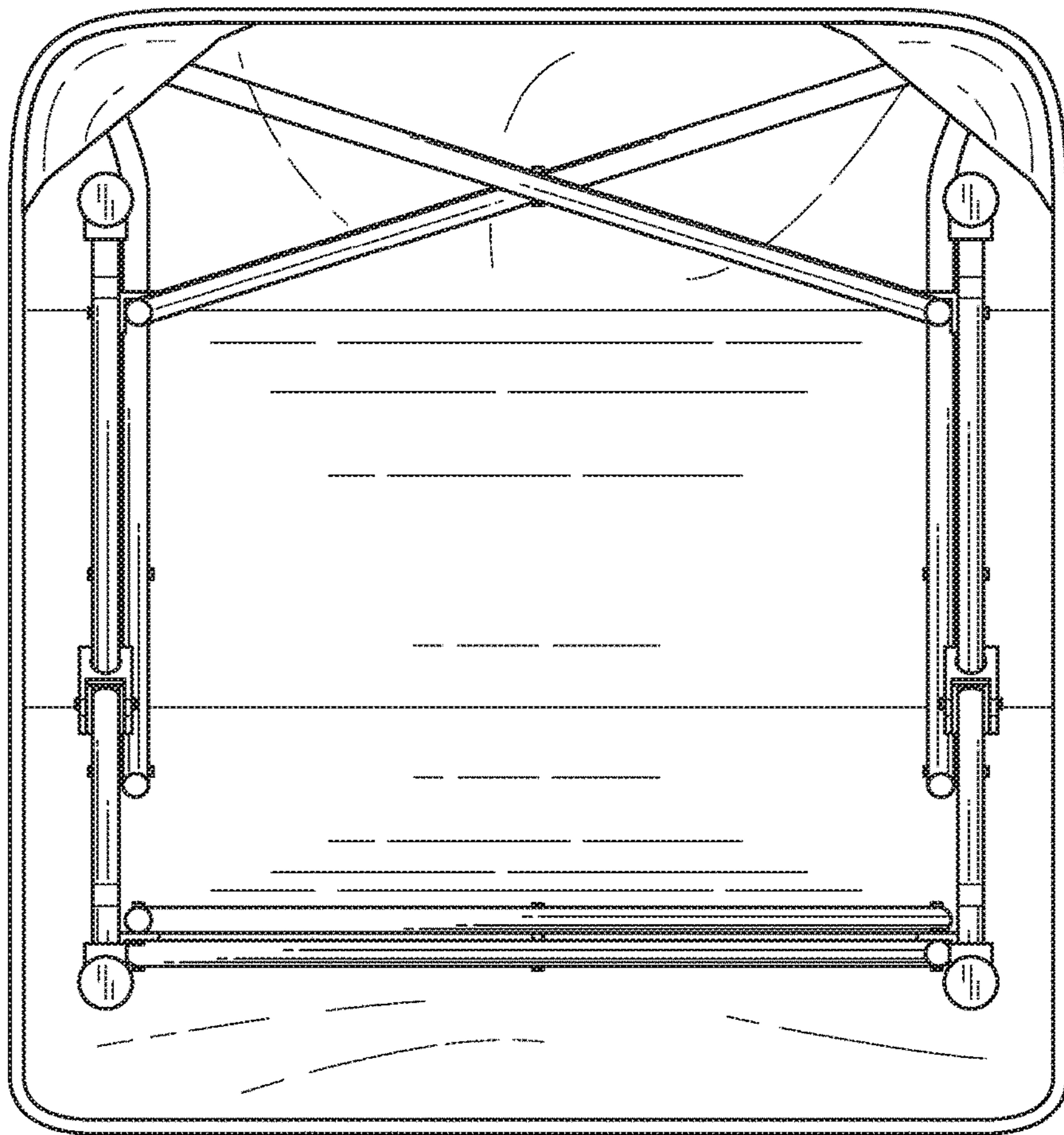

FIG. 15

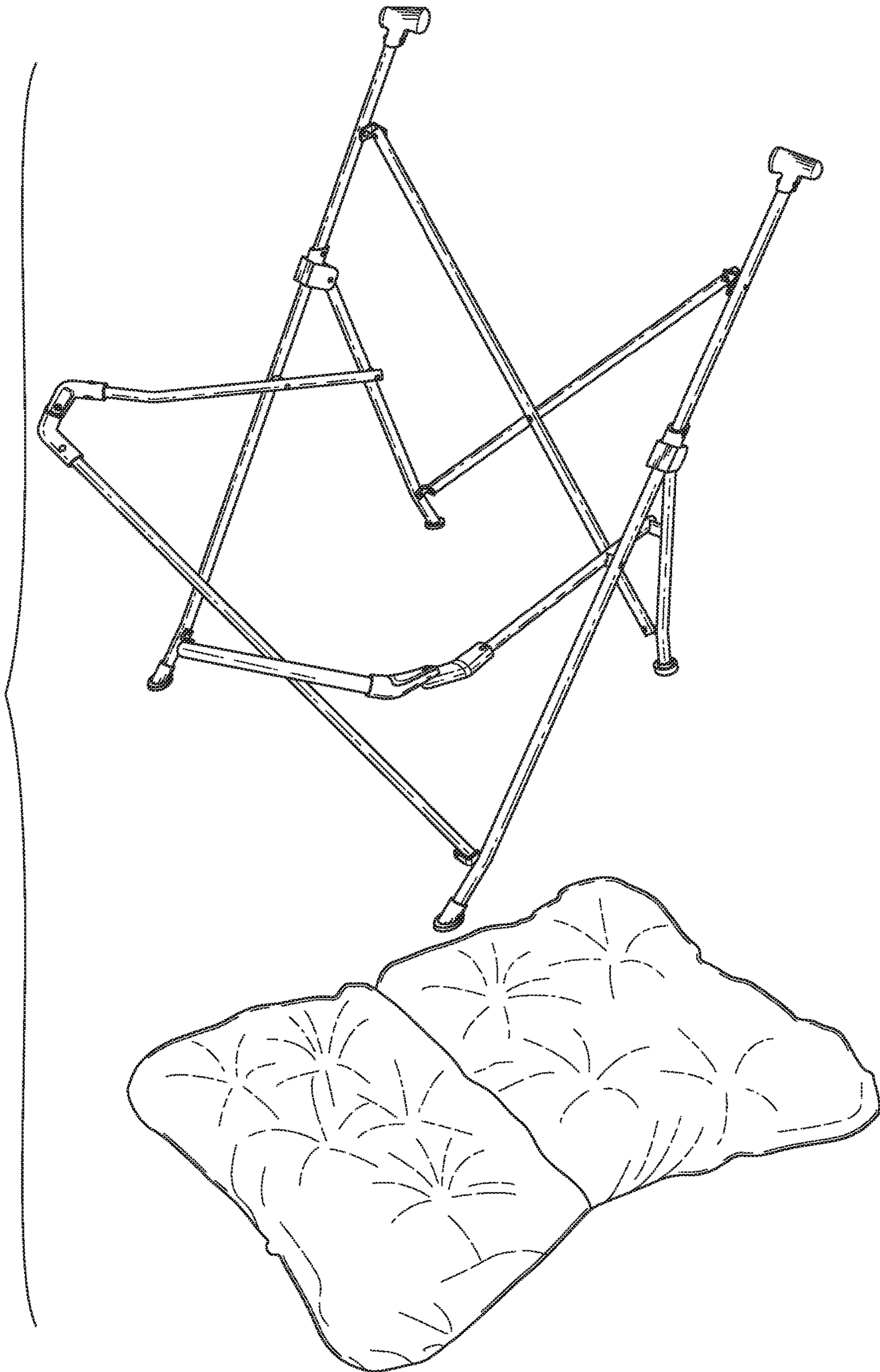

FIG. 16

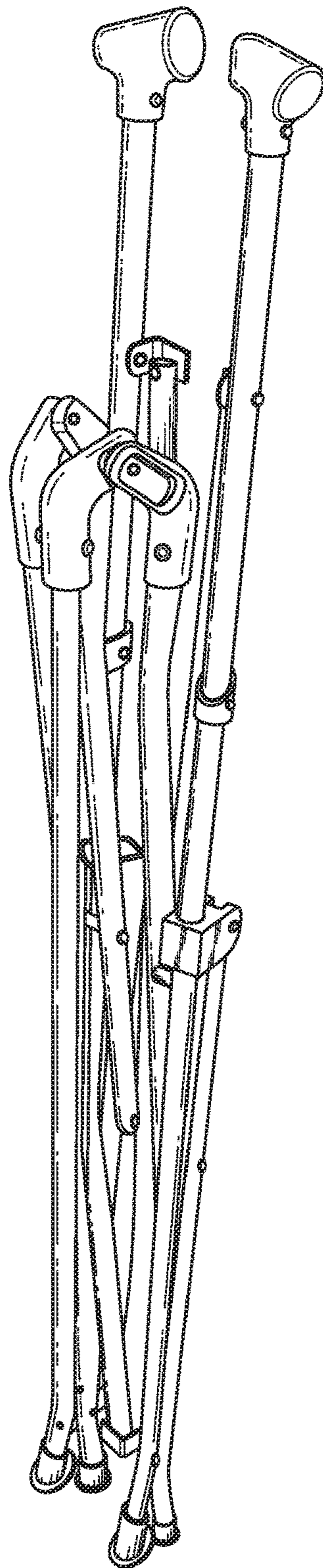

FIG. 17