



US00D816998S

(12) **United States Design Patent**  
**Greenwood**

(10) **Patent No.: US D816,998 S**

(45) **Date of Patent: \*\* \*May 8, 2018**

(54) **RECTANGULAR BIN**

(71) Applicant: **YouCopia Products Inc**, Chicago, IL  
(US)

(72) Inventor: **Mark Greenwood**, Arlington Hts., IL  
(US)

(73) Assignee: **YOUCOPIA PRODUCTS INC**,  
Chicago, IL (US)

(\*) Notice: This patent is subject to a terminal disclaimer.

(\*\*) Term: **15 Years**

(21) Appl. No.: **29/579,762**

(22) Filed: **Oct. 3, 2016**

(51) **LOC (11) Cl.** ..... **03-01**

(52) **U.S. Cl.**  
USPC ..... **D3/312**

(58) **Field of Classification Search**  
USPC ..... D3/304, 317, 318, 309, 312, 314, 315;  
D32/35-37; D7/543, 550.1, 601, 602,  
D7/368, 396.1  
CPC ..... A47G 19/12; A47G 23/06; A47J 47/14;  
B65D 1/22; B65D 1/34; B65D 1/38;  
B65D 21/00

See application file for complete search history.

(56) **References Cited**

**U.S. PATENT DOCUMENTS**

D307,348 S *	4/1990	Yoshikawa	.....	D3/314
D364,272 S *	11/1995	Brightbill	.....	D3/312
D372,583 S *	8/1996	Brightbill	.....	D3/312
D504,017 S *	4/2005	Zimmerman	.....	D3/309

D551,455 S *	9/2007	Norvell	.....	D3/306
D578,308 S *	10/2008	Simas	.....	D3/304
D665,848 S *	8/2012	Lee	.....	D19/92
D675,825 S *	2/2013	Levie	.....	D3/311
D775,830 S *	1/2017	Duvigneau	.....	D3/304
D794,959 S *	8/2017	Takagaki	.....	D3/307

\* cited by examiner

*Primary Examiner* — Kelley Donnelly

(74) *Attorney, Agent, or Firm* — Lowe Graham Jones  
PLLC

(57) **CLAIM**

I claim the ornamental design for the rectangular bin, as shown and described.

**DESCRIPTION**

FIG. 1 is a top perspective view of a rectangular bin, showing my new design.

FIG. 2 is a bottom perspective view of the rectangular bin.

FIG. 3 is a left side view of the rectangular bin

FIG. 4 is a right side view of the rectangular bin.

FIG. 5 is a front view of the rectangular bin.

FIG. 6 is a rear view of the rectangular bin.

FIG. 7 is a top view of the rectangular bin; and,

FIG. 8 is a bottom view of the rectangular bin.

The broken lines depict portions of the article that form no part of the claimed design. The outer broken line at the bottom of the bin in FIGS. 2 and 8 represents a boundary such that the interior of the rectangular broken line forms no part of the claimed design. The pair of wavy long-dash short-dash lines in FIGS. 1, 2, and 5-8 form no part of the claimed design and represent an indeterminate length of the rectangular bin.

**1 Claim, 8 Drawing Sheets**

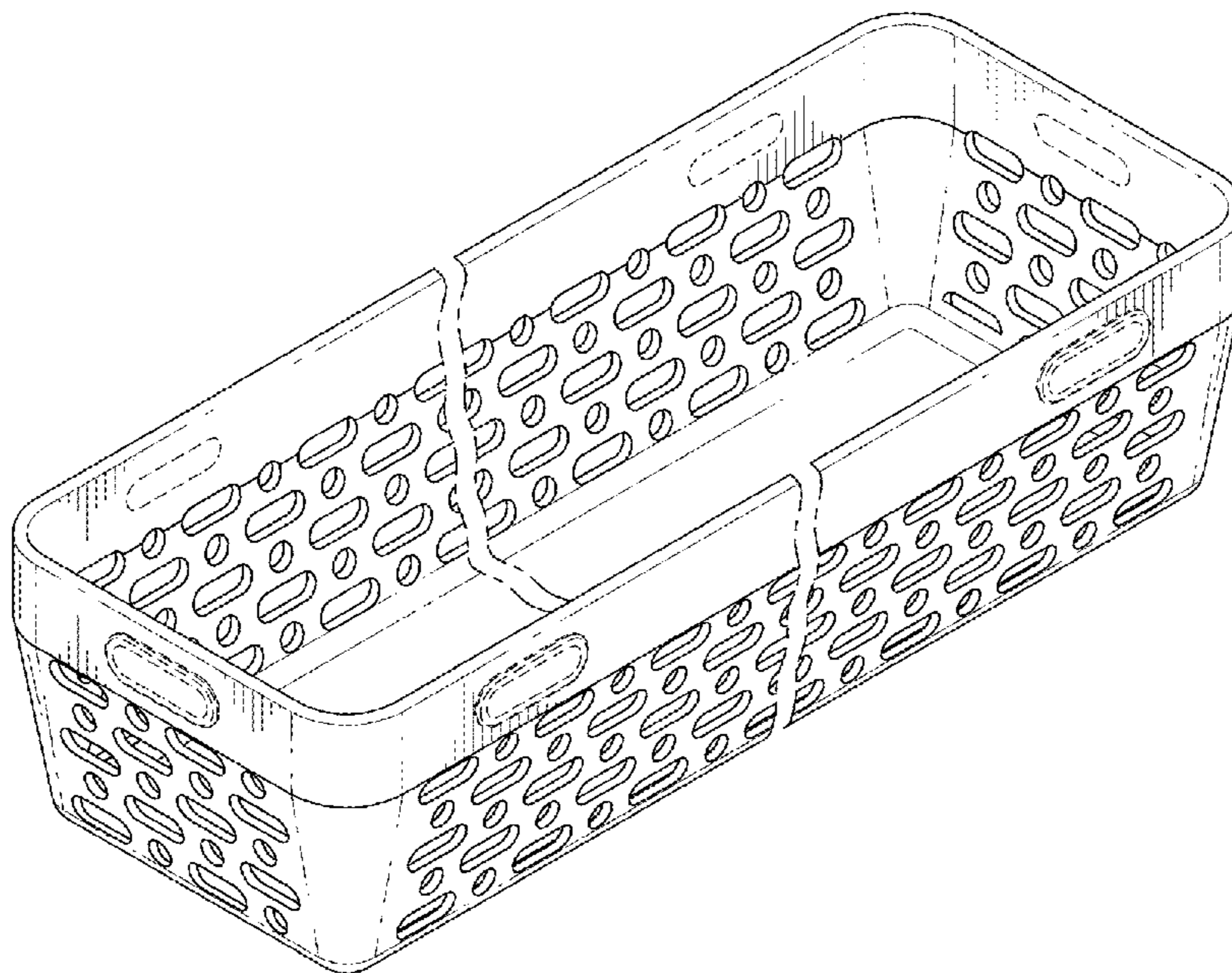

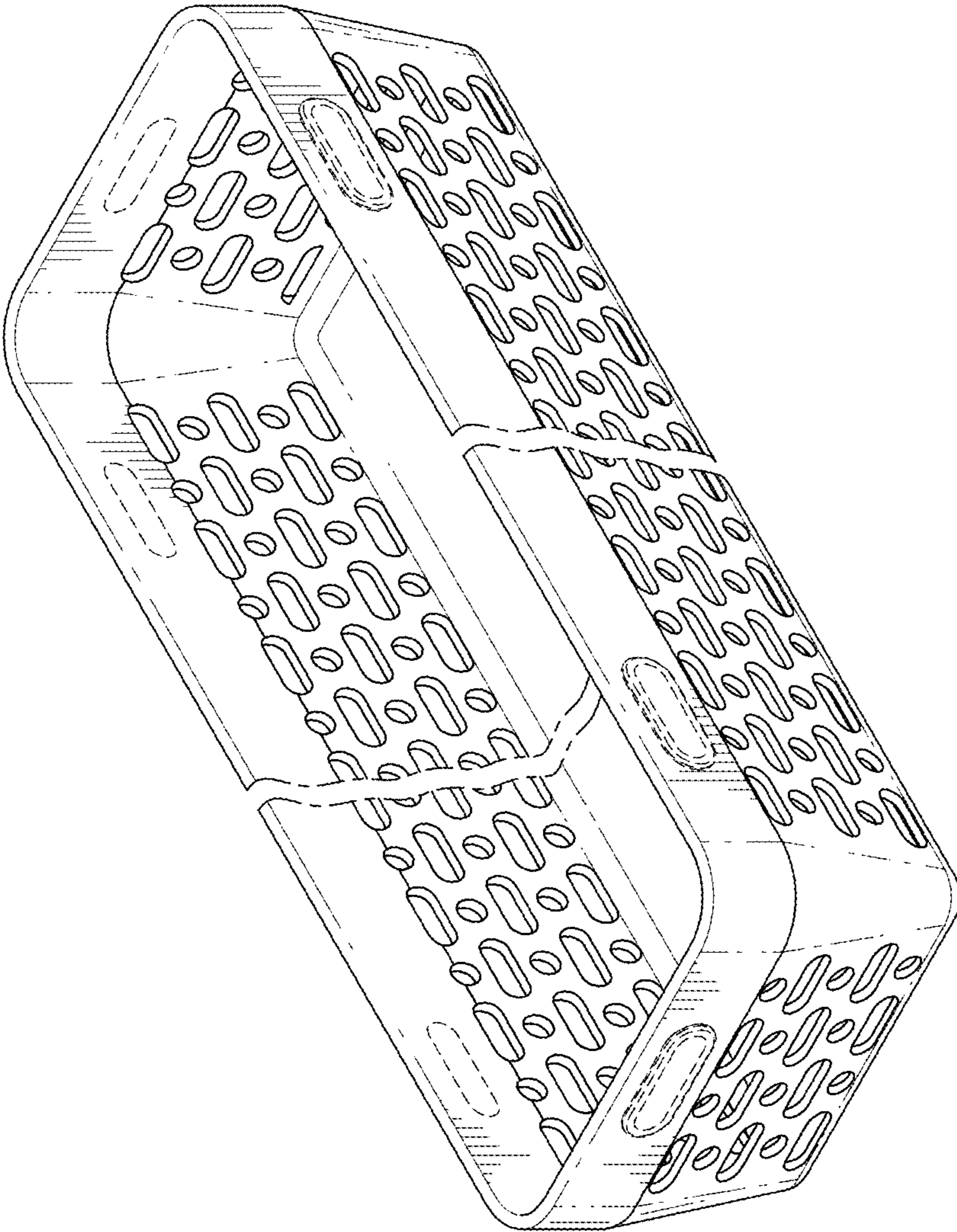

FIG. 1

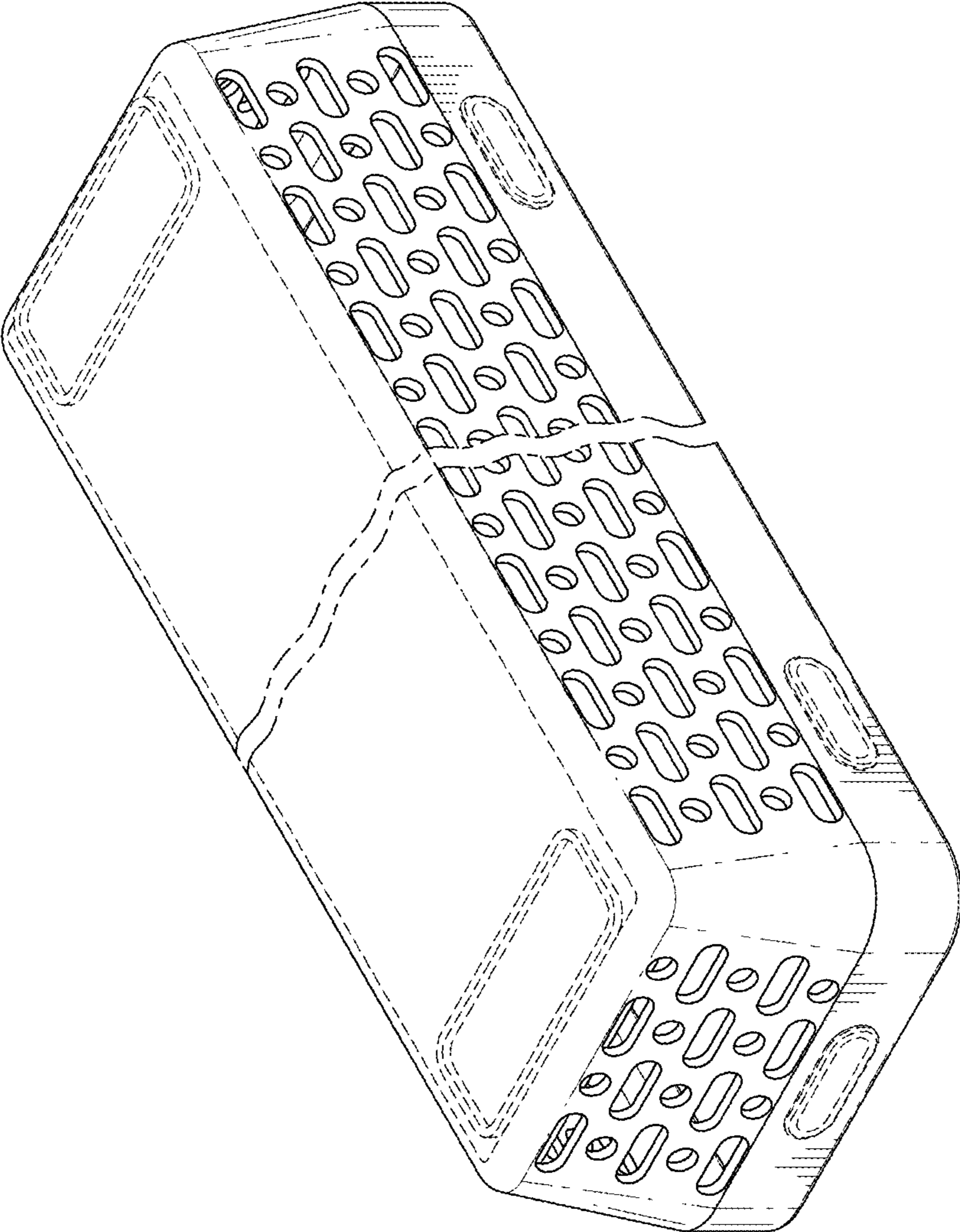

FIG. 2



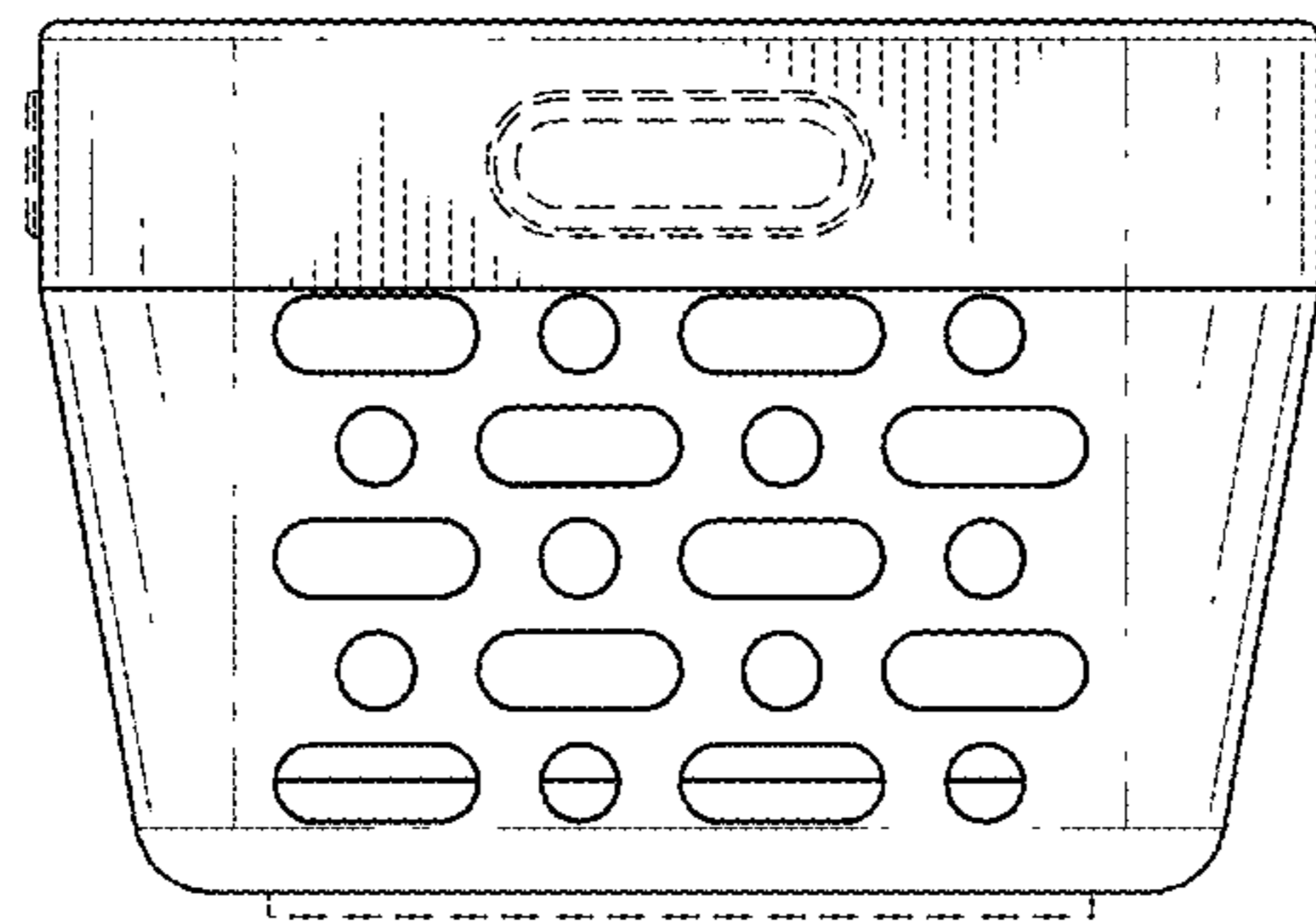

FIG. 3

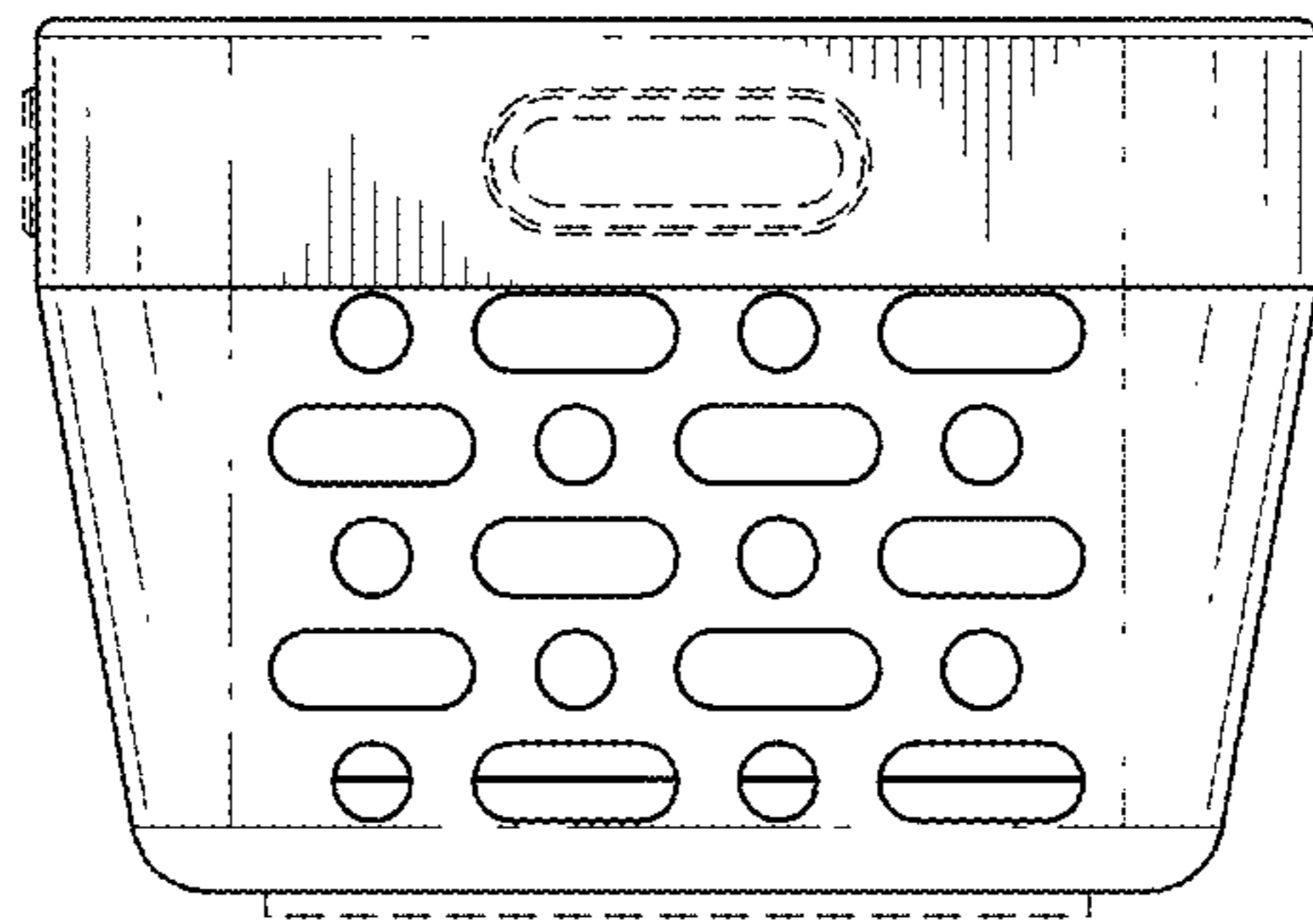

FIG. 4

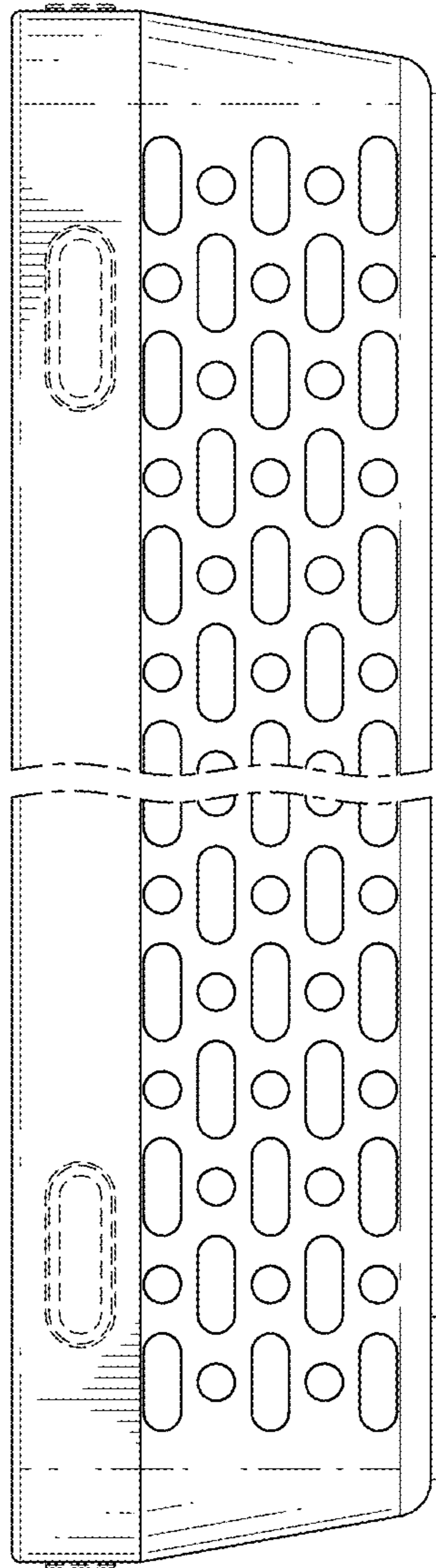

FIG. 5

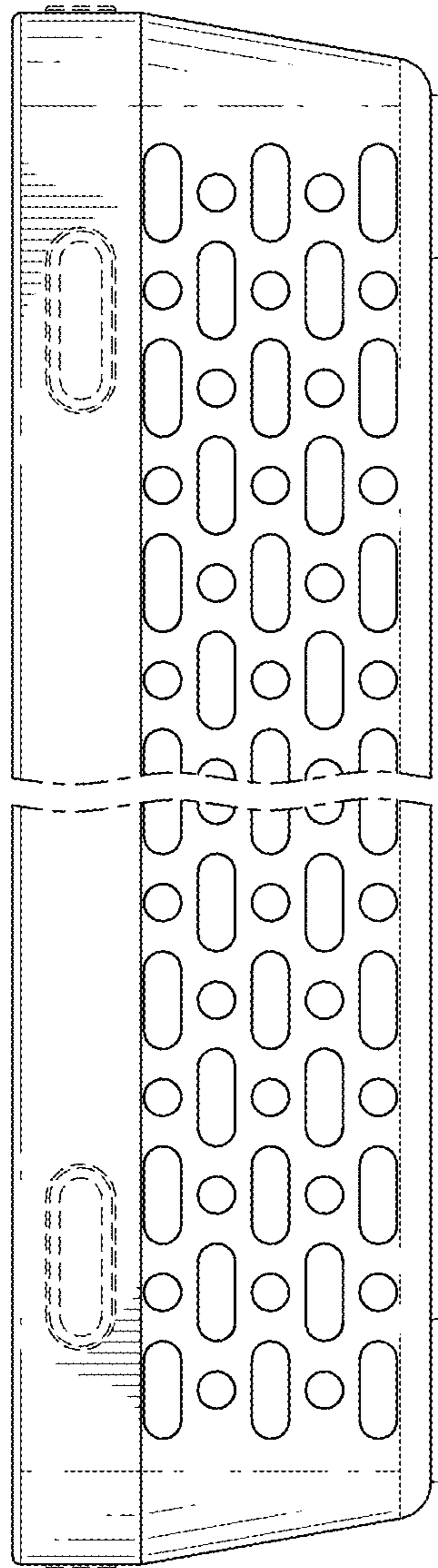

FIG. 6

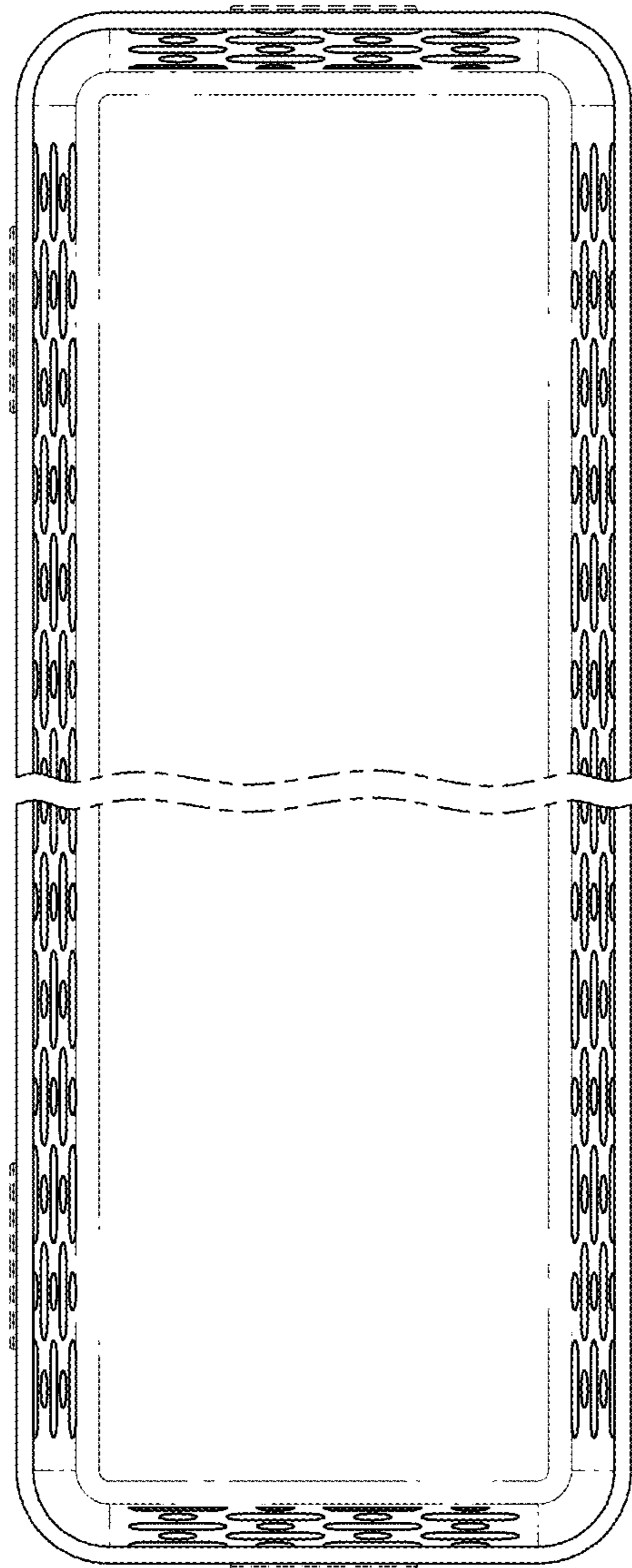

FIG. 7



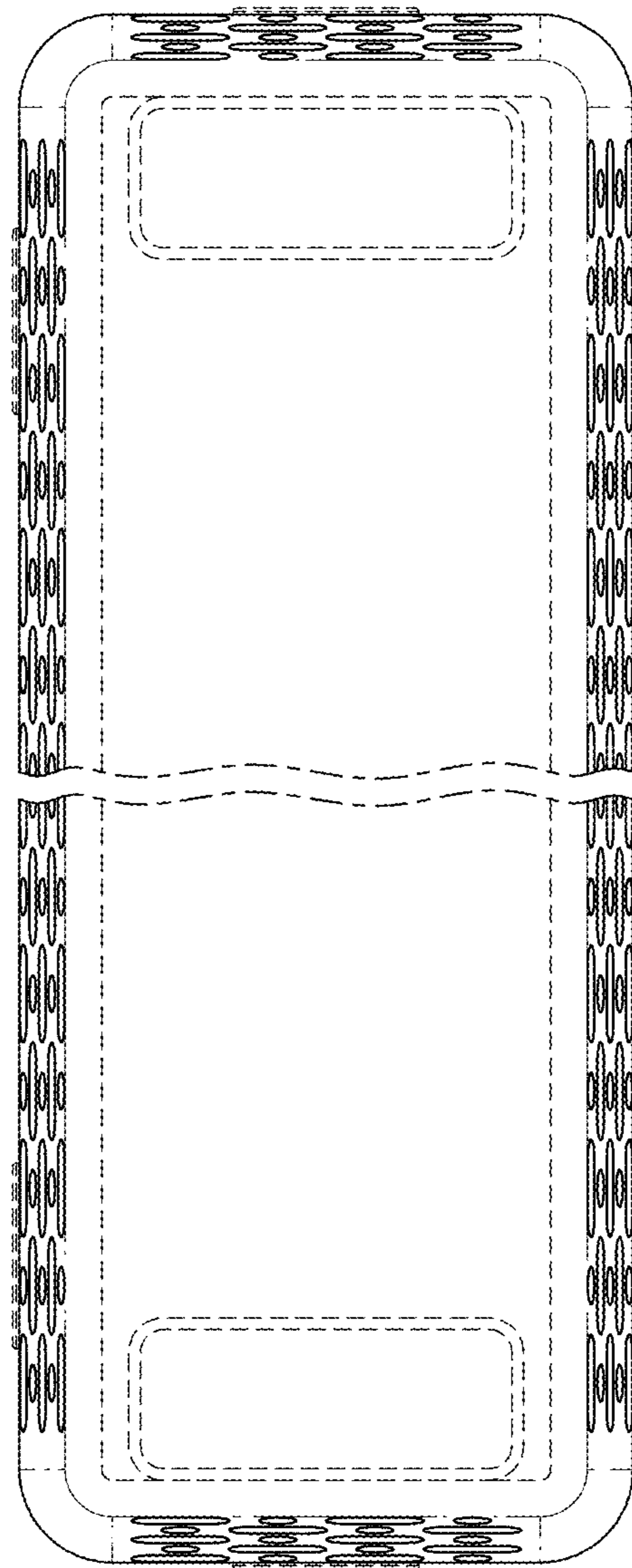

FIG. 8