



US00D816996S

(12) **United States Design Patent**
Majeau et al.

(10) **Patent No.:** **US D816,996 S**

(45) **Date of Patent:** **** May 8, 2018**

(54) **PACKING CUBE**

(71) Applicant: **eBags, LLC**, Greenwood Village, CO (US)

(72) Inventors: **Bernard H. Majeau**, Highlands Ranch, CO (US); **Elena Roy**, Highlands Ranch, CO (US)

(73) Assignee: **eBags, LLC**, Greenwood Village, CO (US)

(**) Term: **15 Years**

(21) Appl. No.: **29/528,515**

(22) Filed: **May 29, 2015**

(51) **LOC (11) Cl.** **03-01**

(52) **U.S. Cl.**
USPC **D3/301**

(58) **Field of Classification Search**
USPC D3/234, 255, 271.9, 320, 256, 262, 279, D3/299, 301, 303, 315, 317, 318, 319,
(Continued)

(56) **References Cited**

U.S. PATENT DOCUMENTS

D285,748 S 9/1986 Feinberg et al.
4,932,506 A 6/1990 Kim et al.
(Continued)

OTHER PUBLICATIONS

Eagle Creek website, Pack-It Sport Quick Trip bag, obtained on line on Aug. 28, 2015 at: http://shop.eaglecreek.com/packit-sport-quick-trip/d/1469_cl_-1, 3 pgs.

Primary Examiner — Sandra S Snapp
Assistant Examiner — Holly E Thurman

(74) *Attorney, Agent, or Firm* — Perkins Coie LLP

(57) **CLAIM**

The ornamental design for a packing cube, as shown and described.

DESCRIPTION

FIG. 1 is a perspective view of the packing cube, showing our new design, in a double-rectangular configuration. FIG. 2 is a front view thereof. FIG. 3 is a back view thereof. FIG. 4 is a right side view thereof. FIG. 5 is a left side view thereof. FIG. 6 is a top view thereof. FIG. 7 is a bottom view thereof. FIG. 8 is a perspective view thereof, shown in an open state of use. FIG. 9 is a perspective view of the packing cube, showing our new design, in a rectangular configuration. FIG. 10 is a front view thereof. FIG. 11 is a back view thereof. FIG. 12 is a right side view thereof. FIG. 13 is a left side view thereof. FIG. 14 is a top view thereof. FIG. 15 is a bottom view thereof. FIG. 16 is a perspective view thereof, shown in an open state of use. FIG. 17 is a perspective view of the packing cube, showing our new design, in a square configuration. FIG. 18 is a front view thereof. FIG. 19 is a back view thereof. FIG. 20 is a right side view thereof. FIG. 21 is a left side view thereof. FIG. 22 is a top view thereof. FIG. 23 is a bottom view thereof; and, FIG. 24 is a perspective view thereof, shown in an open state of use. To the extent the packing cubes in FIGS. 1-24 include broken lines, the broken lines depict portions of the packing cube that form no part of the claimed design.

1 Claim, 17 Drawing Sheets

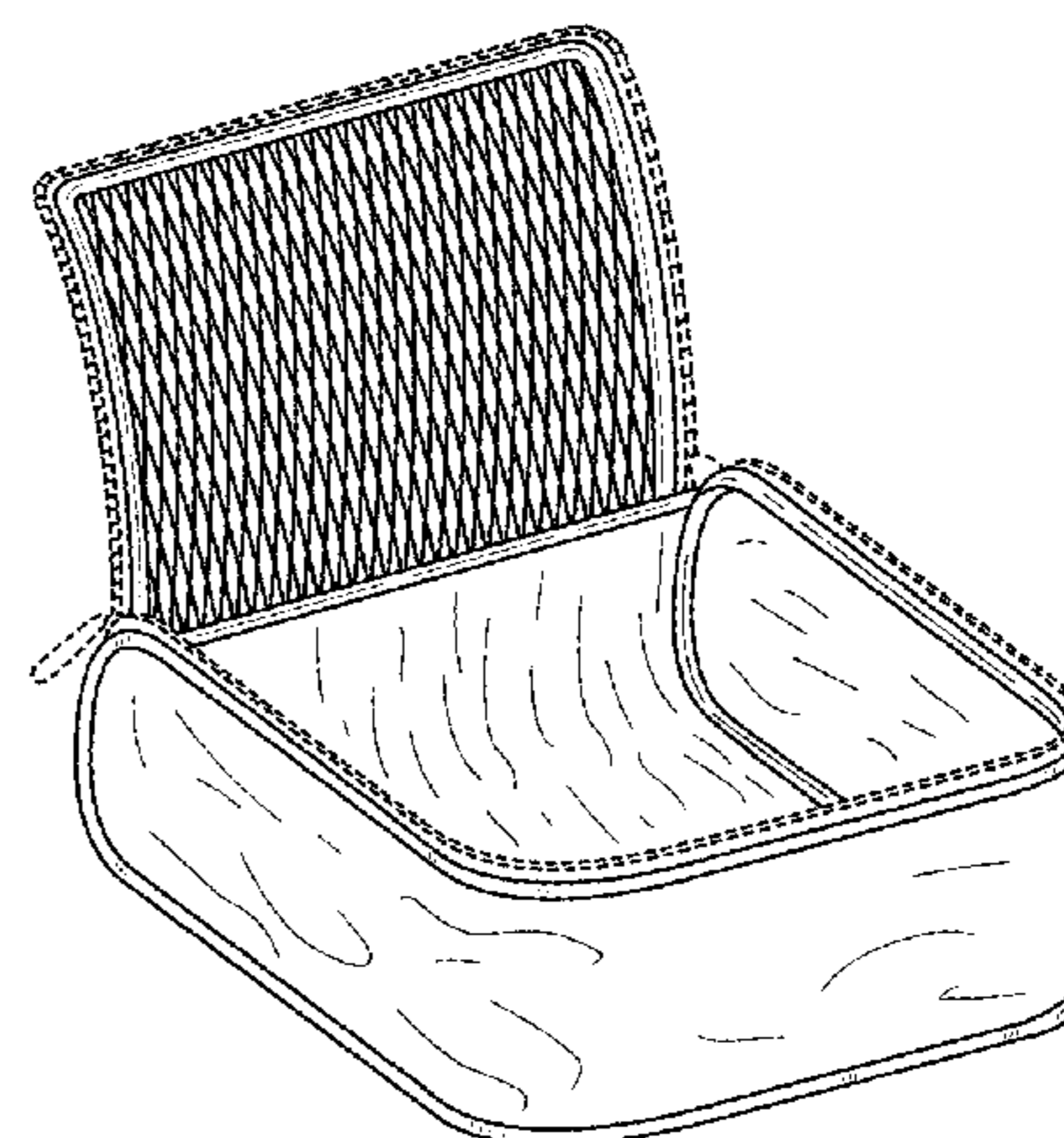
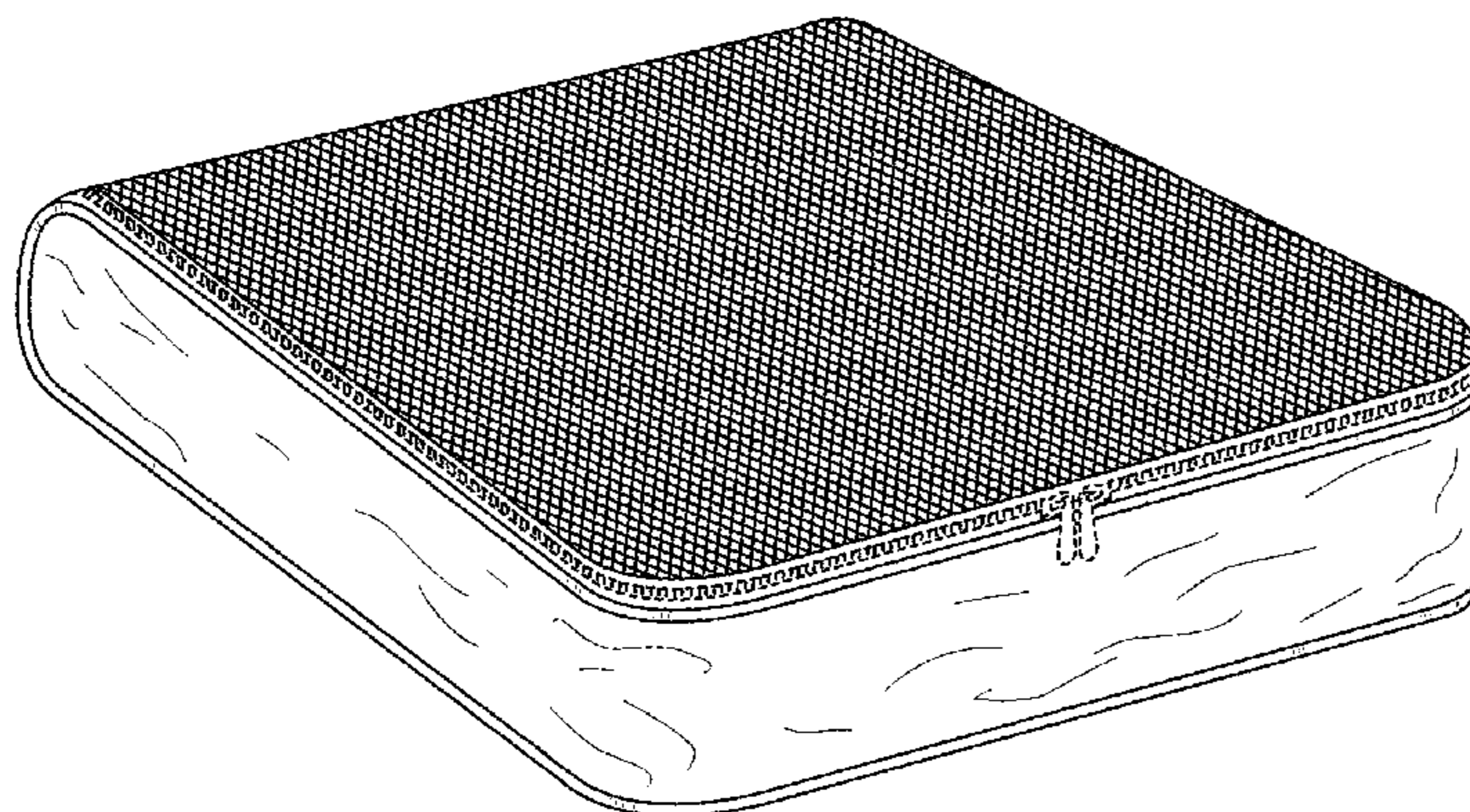

(58) **Field of Classification Search**

USPC D3/273, 289, 292, 294–296, 232, 244;
 D9/414; D7/601, 602, 709
 CPC .. A45C 1/00; A45C 1/02; A45C 1/024; A45C
 1/08; A45C 3/00; A45C 3/10; A45C
 2003/001; A45C 2011/003; A45C 5/00;
 A45C 7/00; A45C 7/0018; A45C 7/0054;
 A45C 7/0059; A45C 7/0095; A45C
 2200/00; A45C 13/00; A45C 13/001;
 A45C 13/002; A45C 13/08; A45C 11/24;
 A45F 3/00; A45F 3/02; A45F 3/04; A45F
 3/06; A45F 2003/001; A45F 2003/002;
 A45F 2003/006; A45F 2200/00; A45F
 2200/0525
 See application file for complete search history.

(56) **References Cited**

U.S. PATENT DOCUMENTS

D411,664 S * 6/1999 Latshaw D3/201
 D411,918 S * 7/1999 Neuman D3/276

5,964,533	A	10/1999	Ziglar	
D451,672	S *	12/2001	Rasmussen	D3/276
D453,994	S *	3/2002	Meissner	D3/273
D479,041	S *	9/2003	Fonfeder	D3/206
D496,792	S *	10/2004	Crites	D3/278
D497,051	S *	10/2004	Nieves	D3/301
D510,657	S *	10/2005	Fonfeder	D3/206
D525,790	S *	8/2006	Heroux	D3/301
D606,394	S *	12/2009	Stewart	D9/423
D639,064	S *	6/2011	Raible	D3/301
D640,870	S *	7/2011	Regan	D3/299
D659,998	S *	5/2012	Austin	D3/301
D669,270	S *	10/2012	Phillips	D3/301
D712,144	S *	9/2014	Albanese	D3/301
D727,025	S *	4/2015	Dreyer	D3/284
2002/0040834	A1 *	4/2002	Chen	A45C 7/0031 190/103
2003/0106895	A1	6/2003	Kalal	
2005/0045499	A1	3/2005	Bisbal et al.	
2008/0302623	A1	12/2008	Gupton et al.	
2009/0148078	A1	6/2009	Skyler et al.	
2010/0158414	A1	6/2010	Michailidis et al.	
2012/0267365	A1	10/2012	Sabounjian et al.	
2016/0345693	A1	12/2016	Majeau et al.	

* cited by examiner

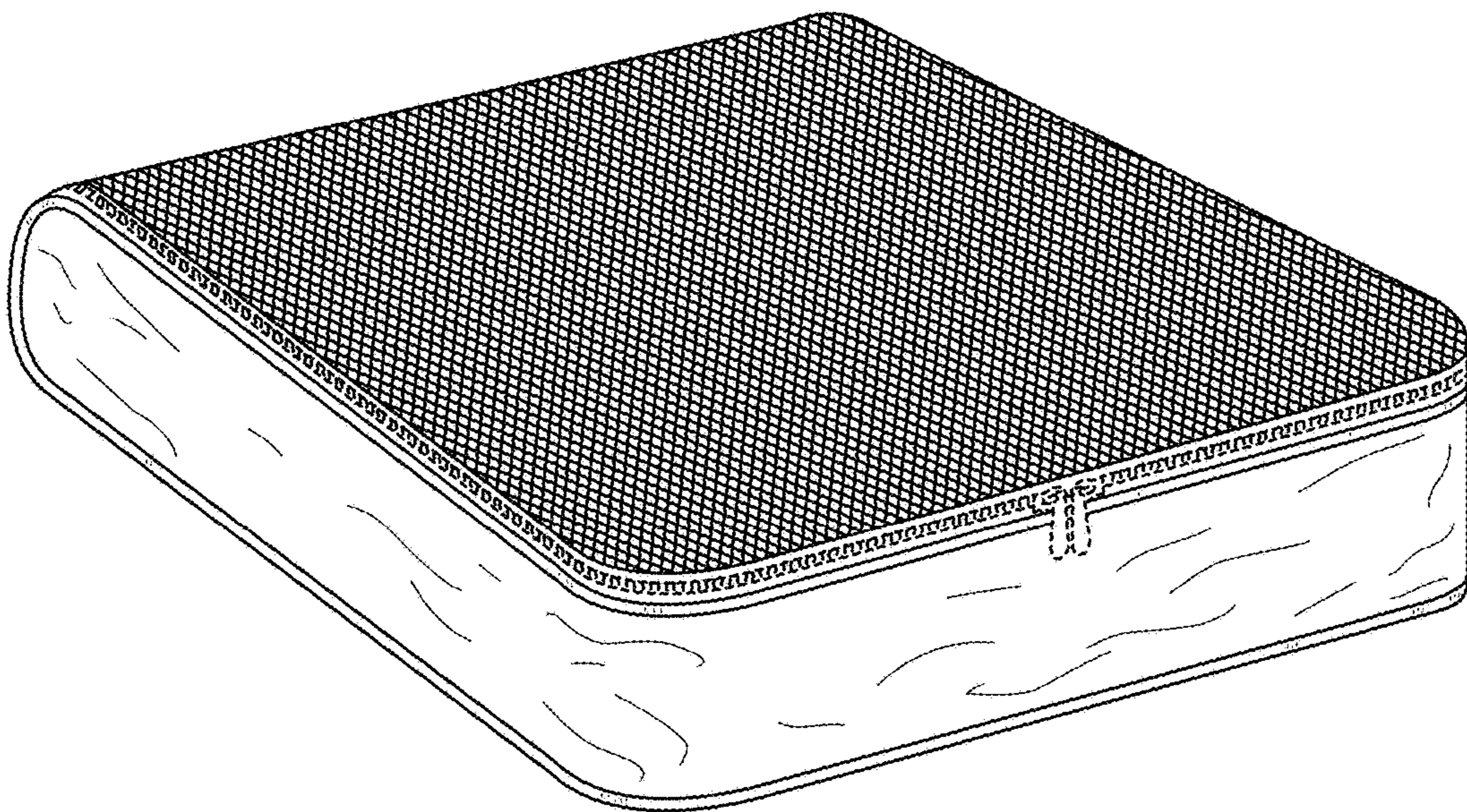

FIG. 1

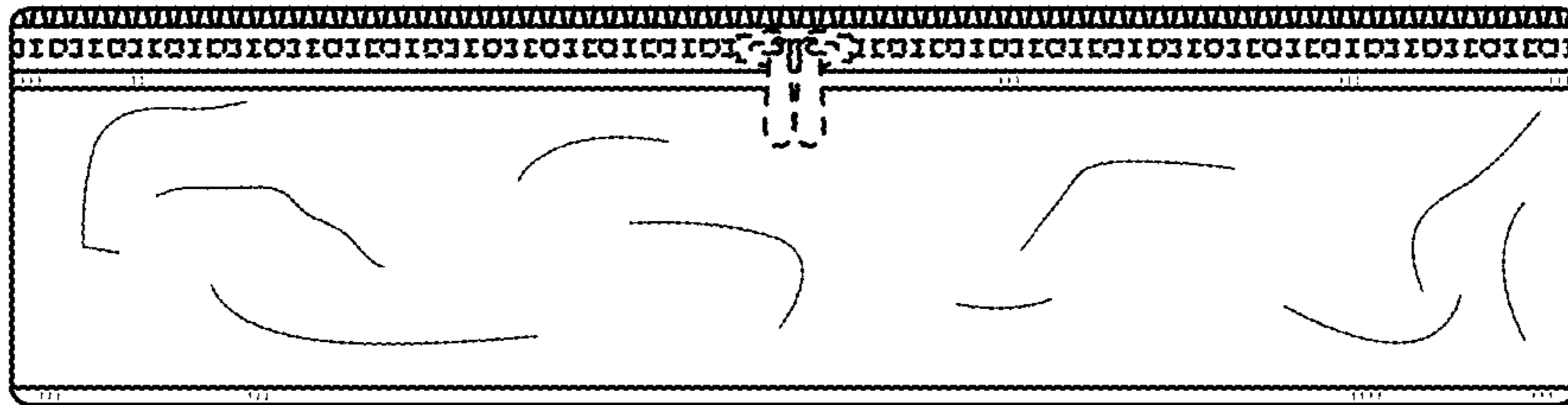

FIG. 2

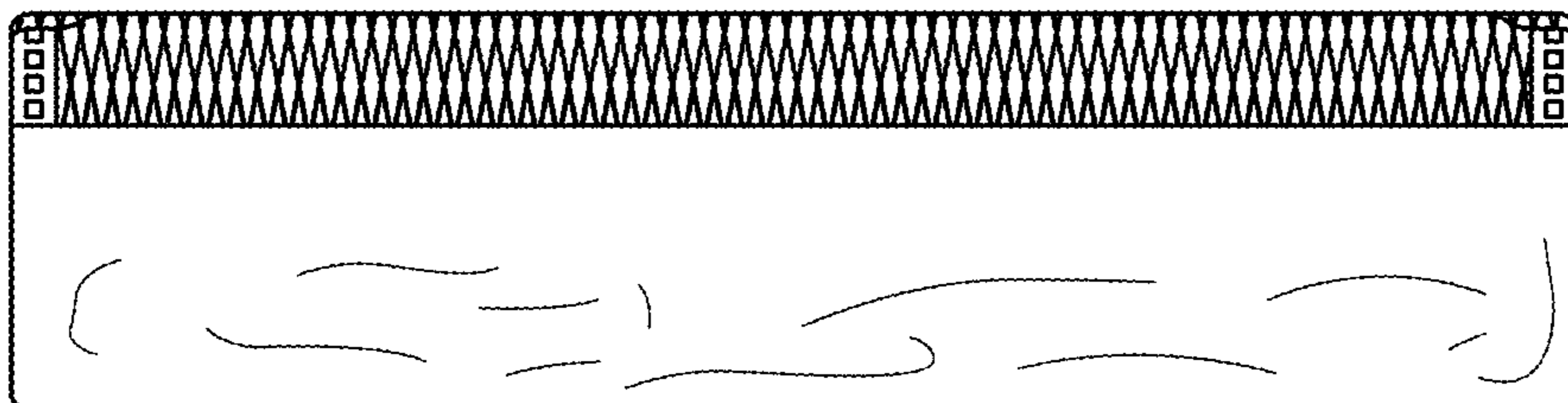

FIG. 3

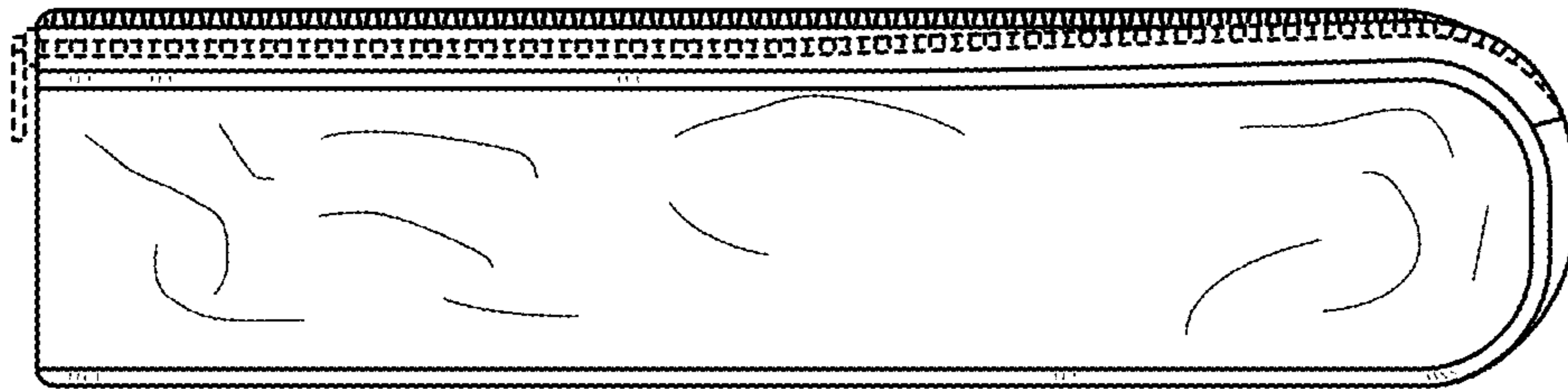

FIG. 4

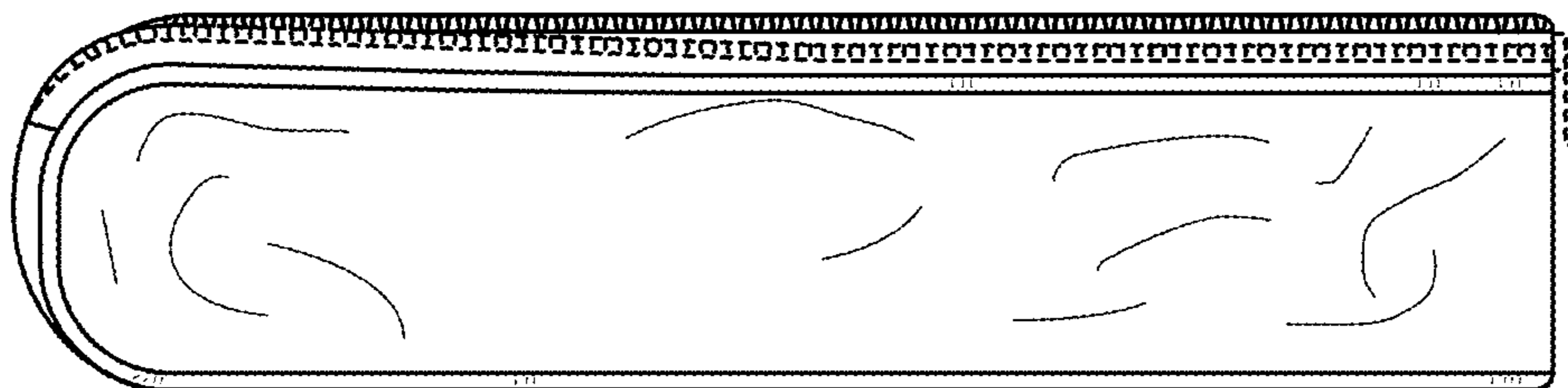

FIG. 5

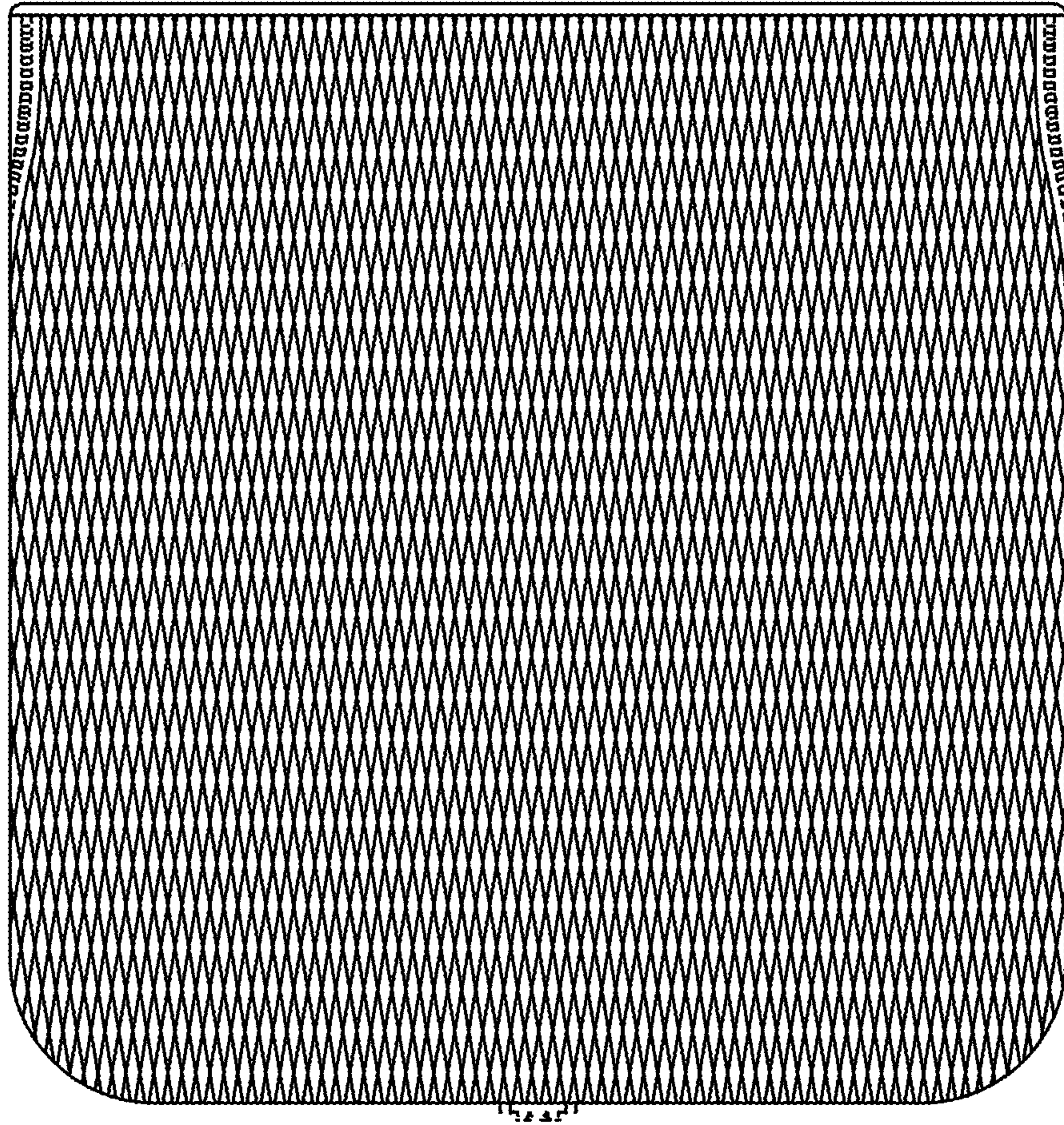

FIG. 6

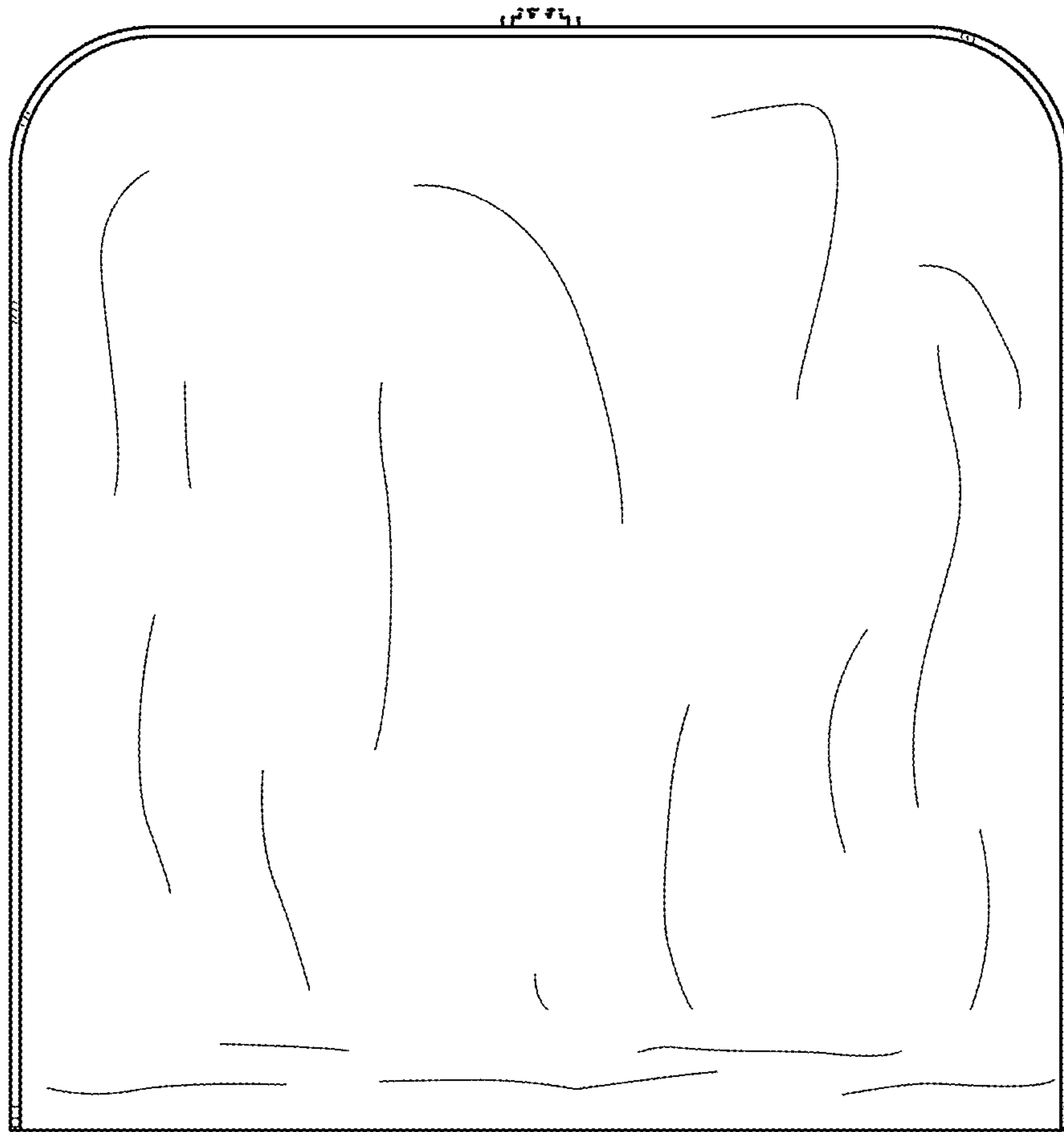

FIG. 7

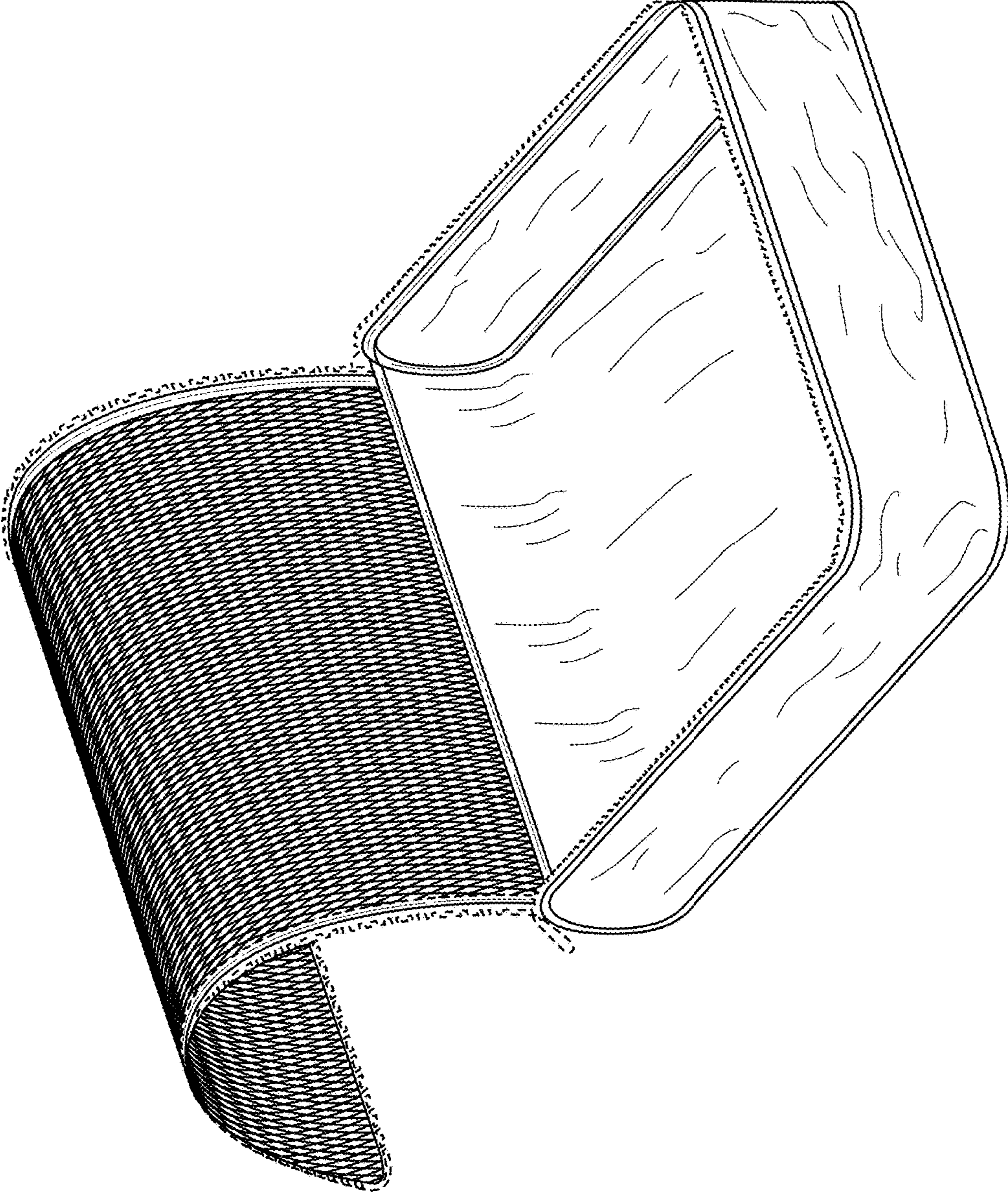

FIG. 8

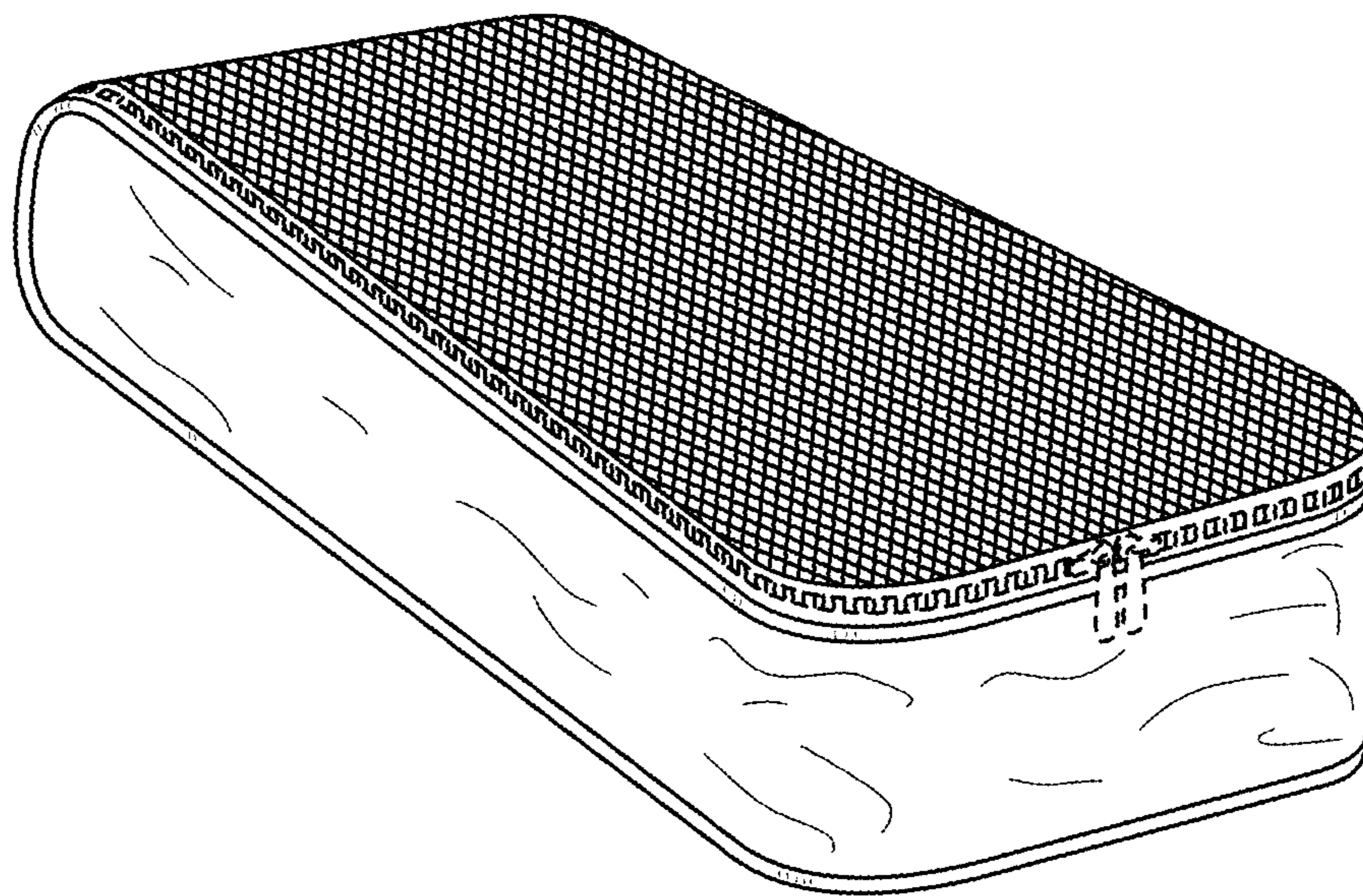

FIG. 9

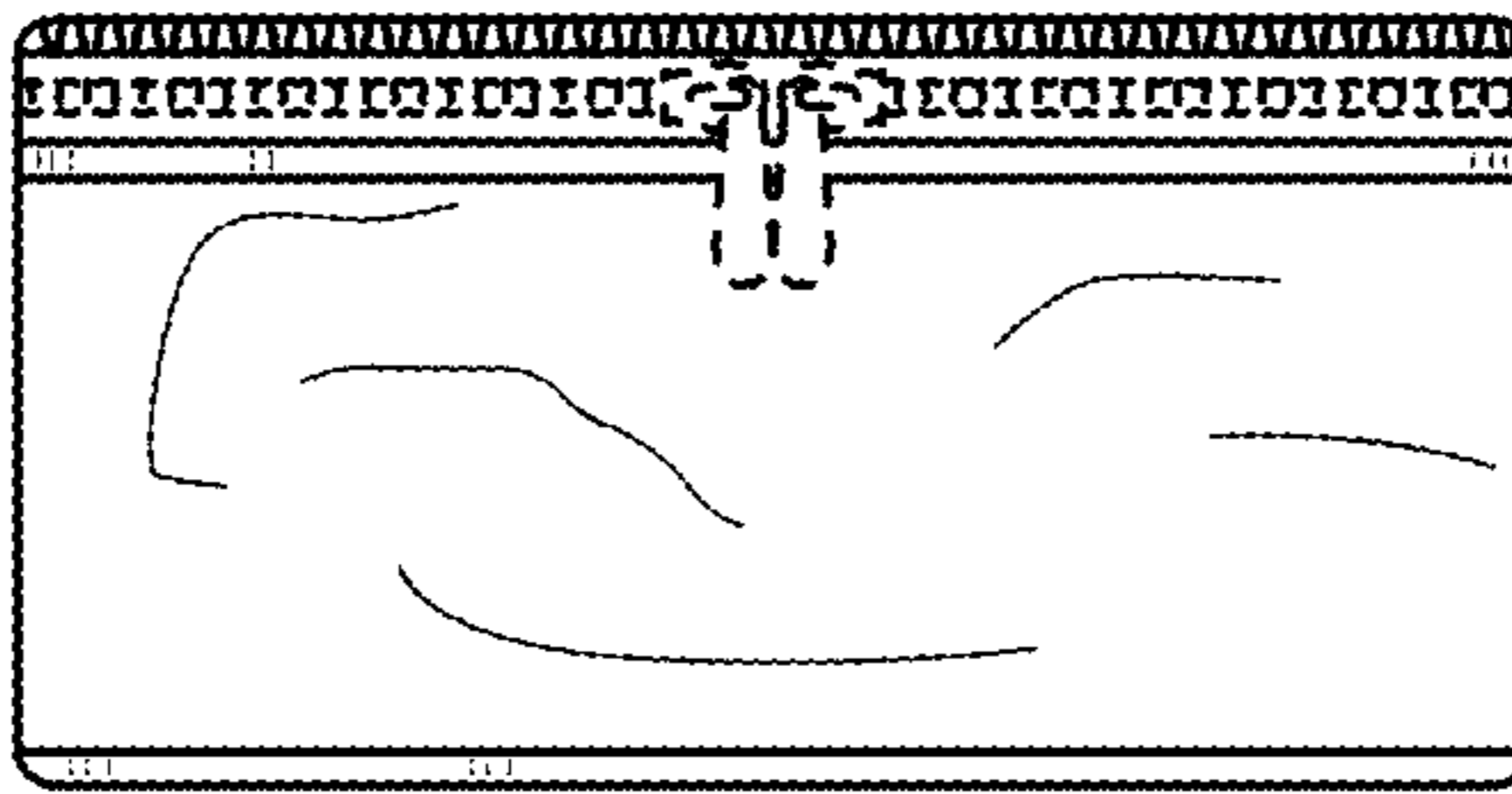

FIG. 10

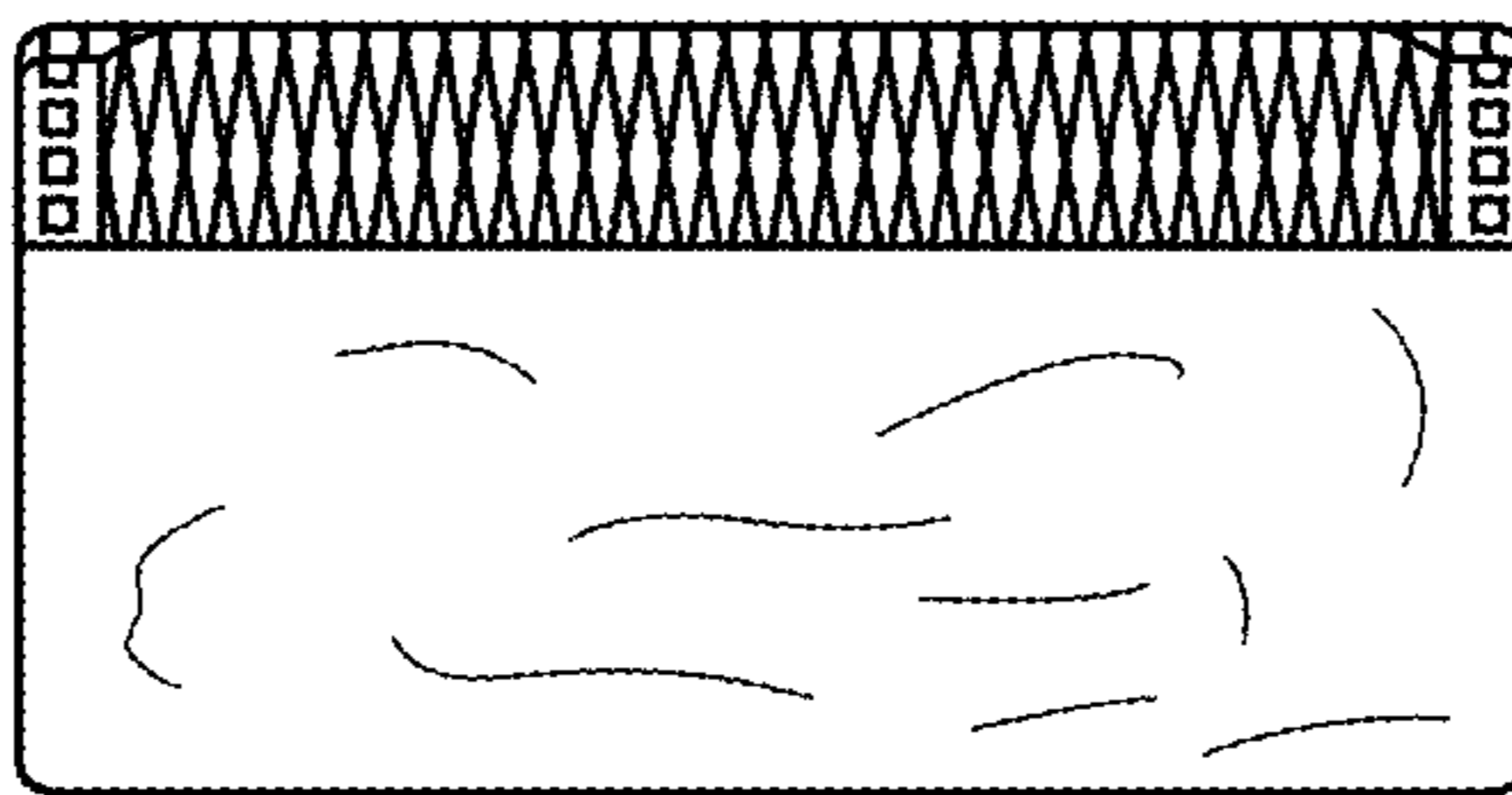

FIG. 11

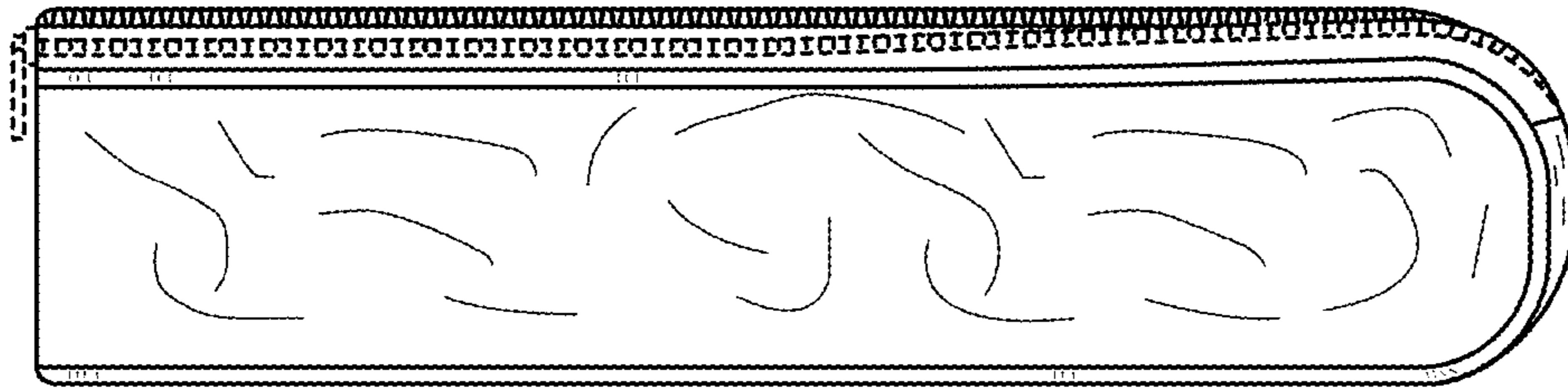

FIG. 12

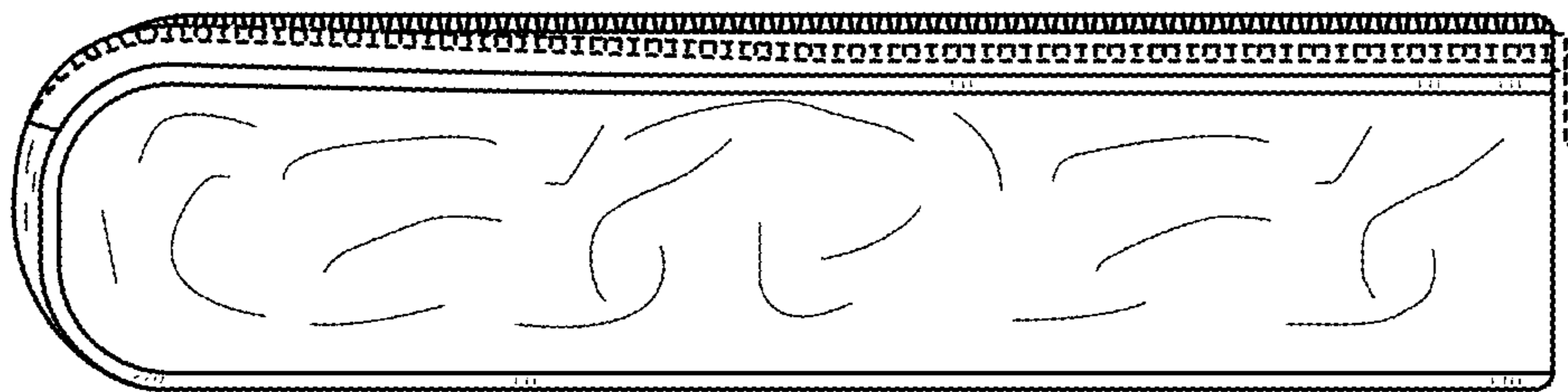

FIG. 13

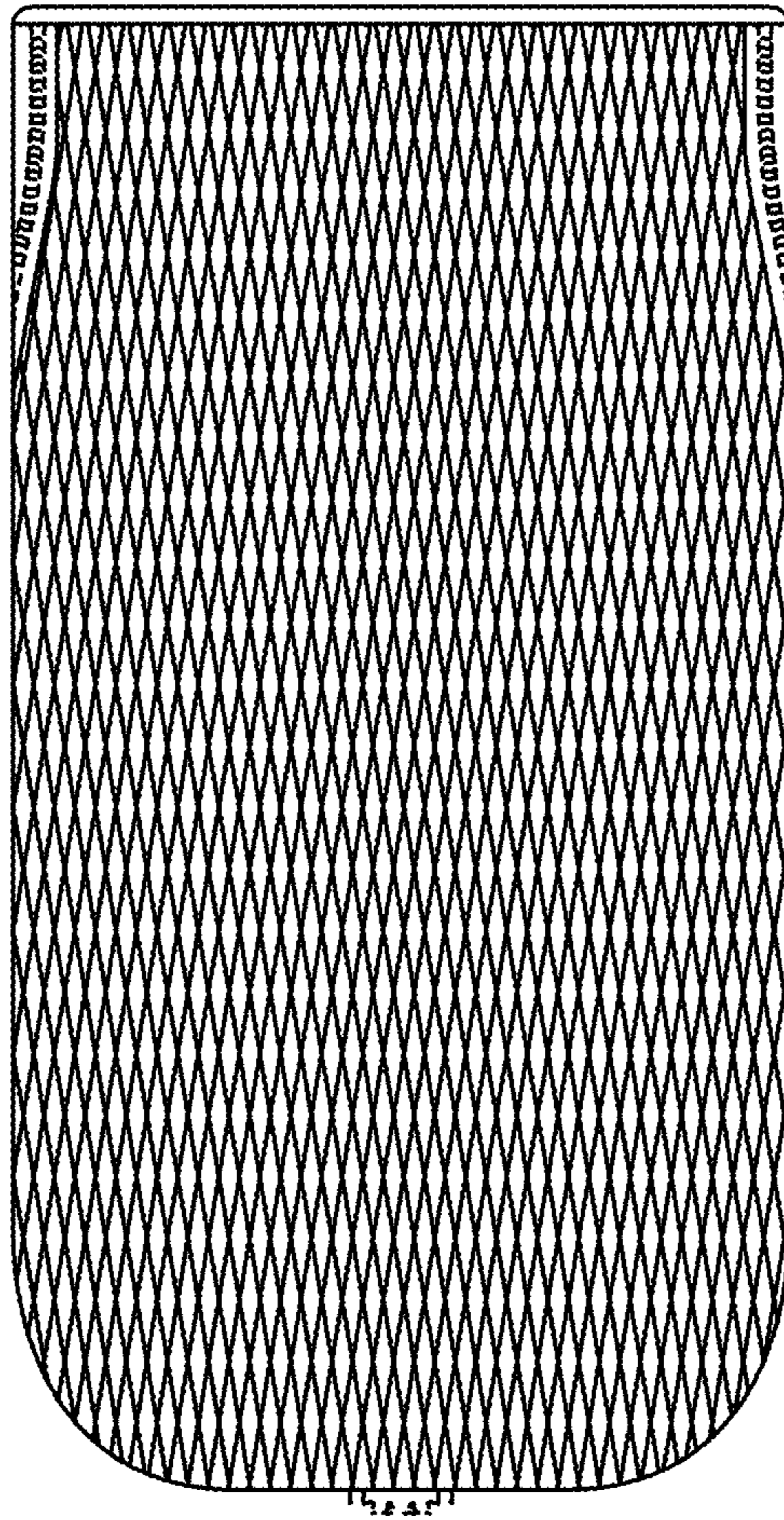

FIG. 14

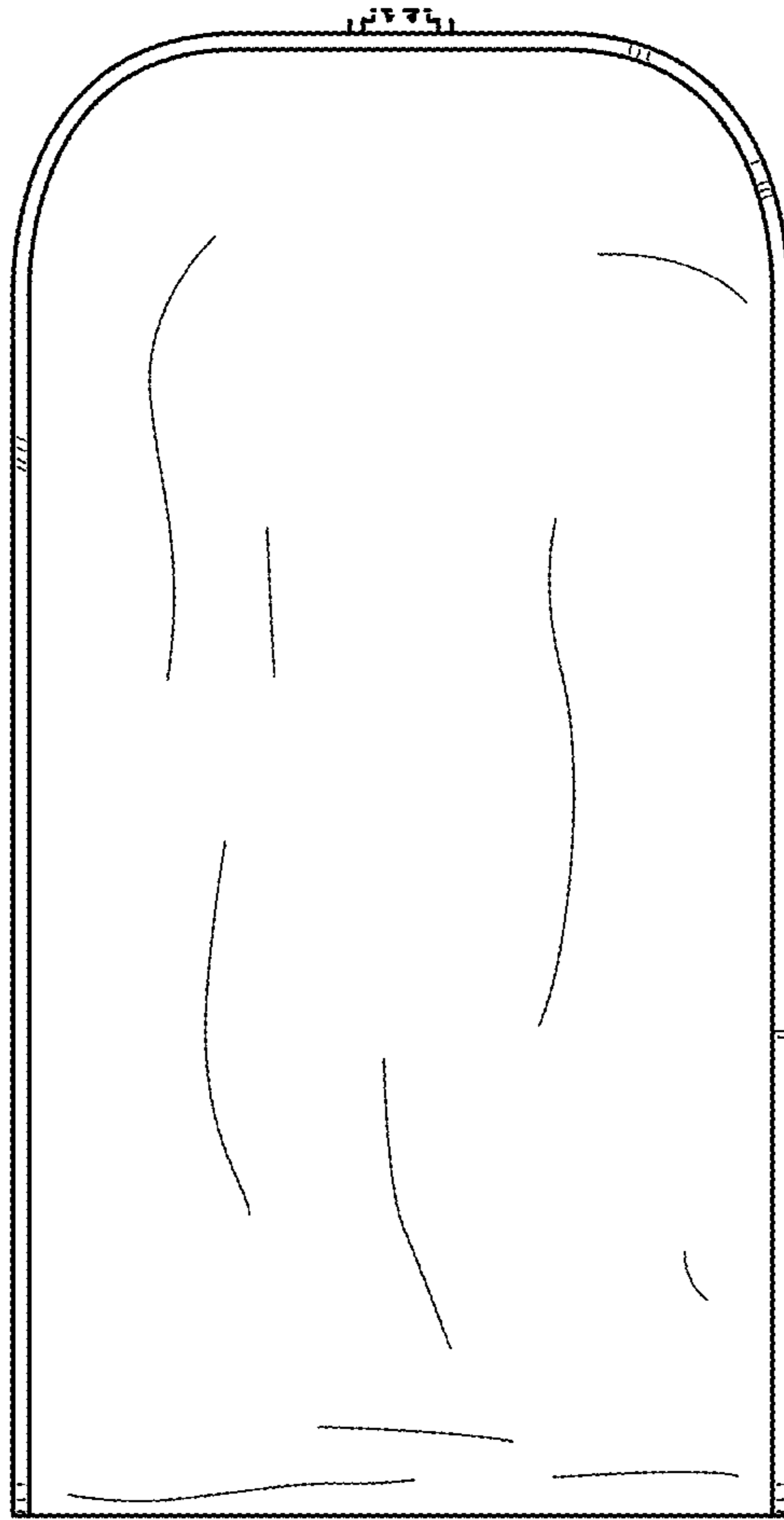

FIG. 15

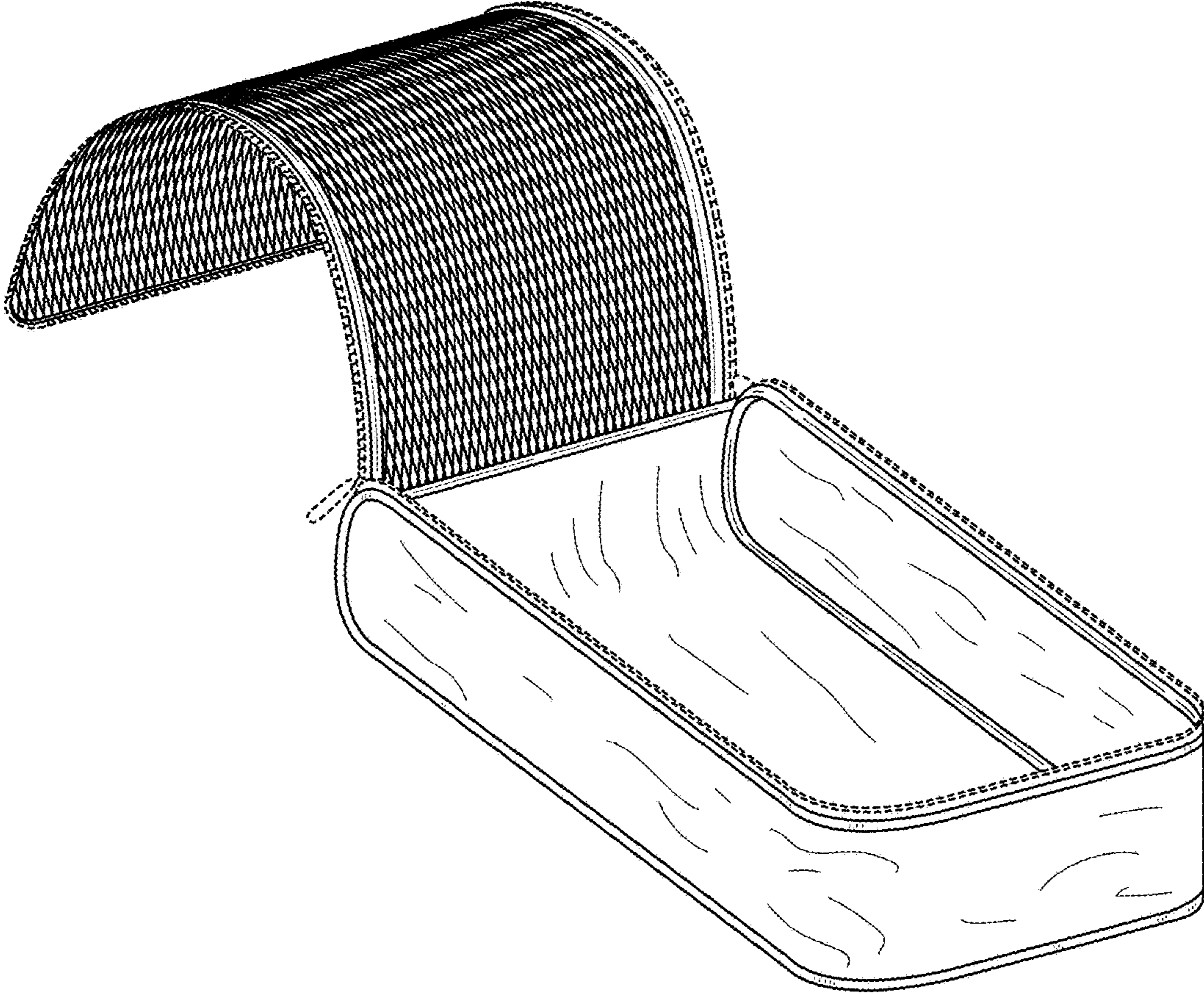

FIG. 16

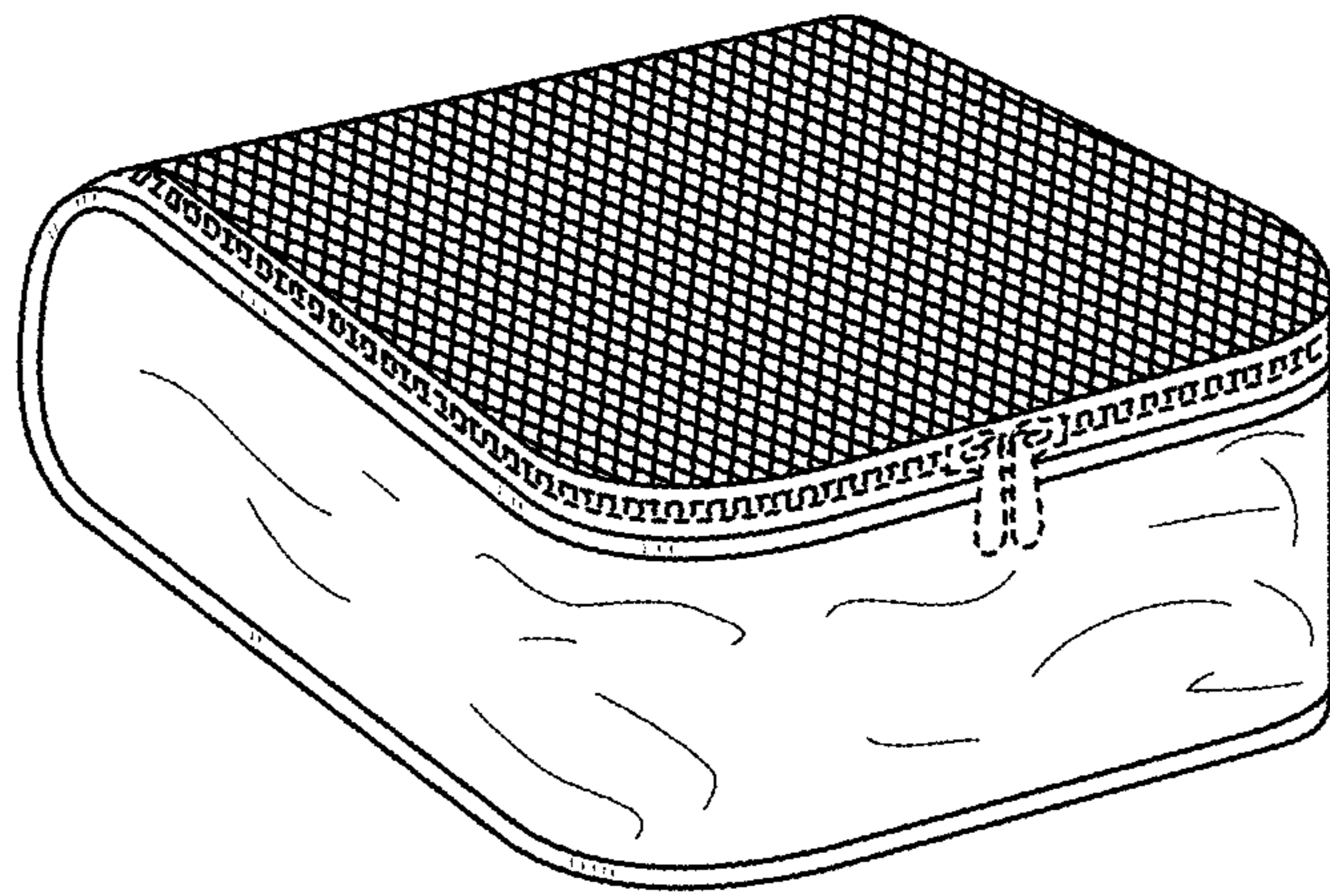

FIG. 17

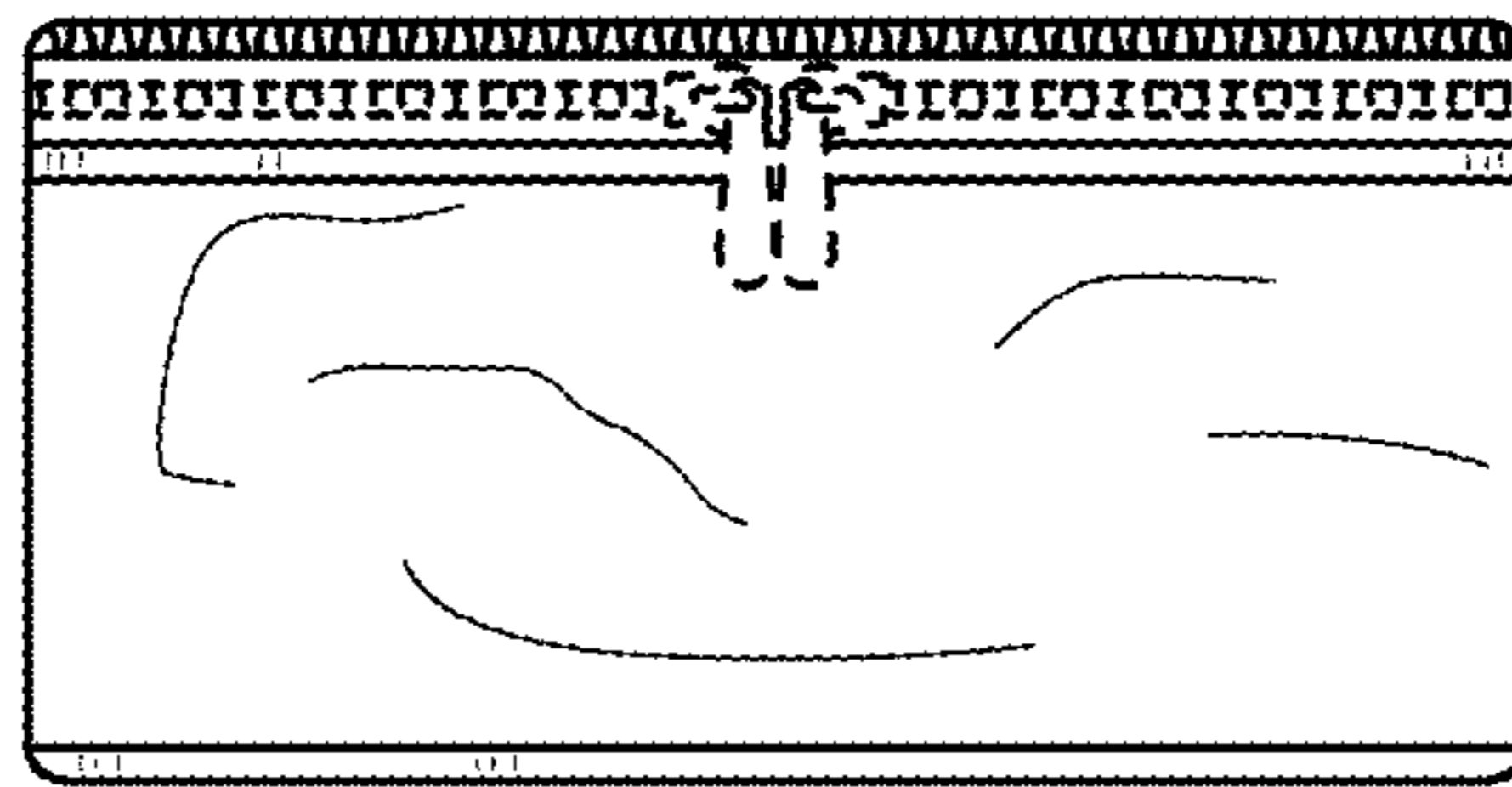

FIG. 18

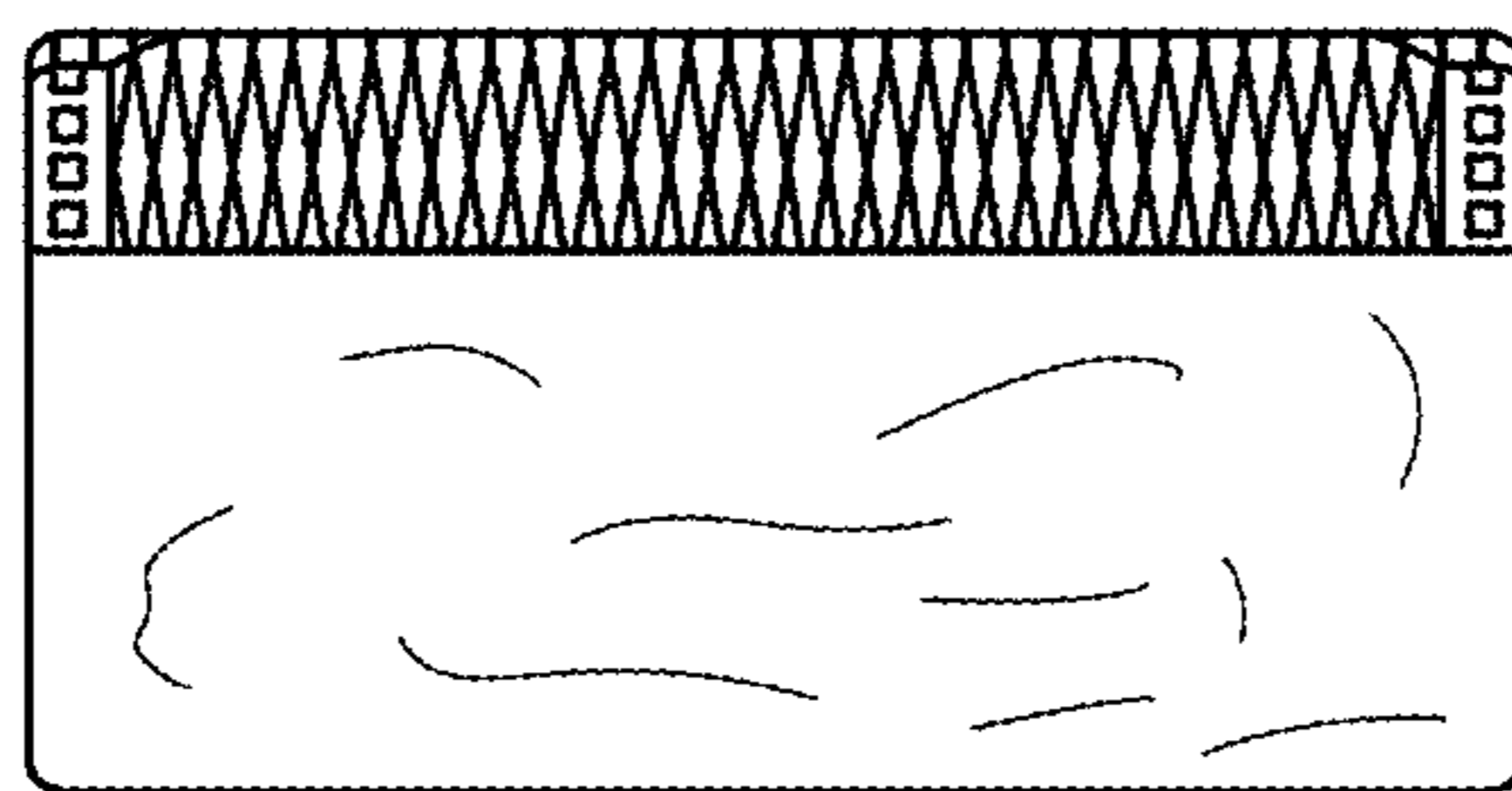

FIG. 19

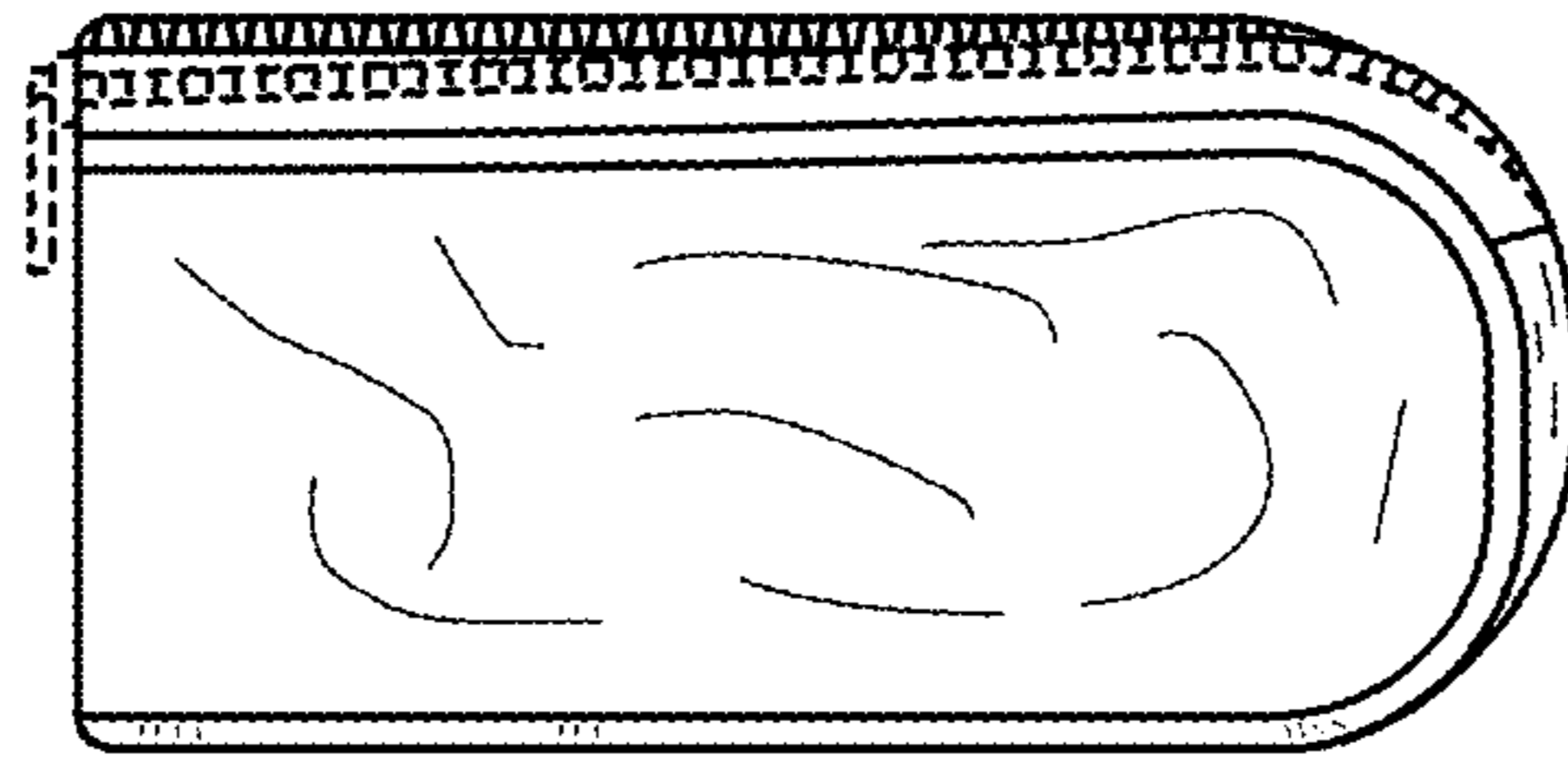

FIG. 20

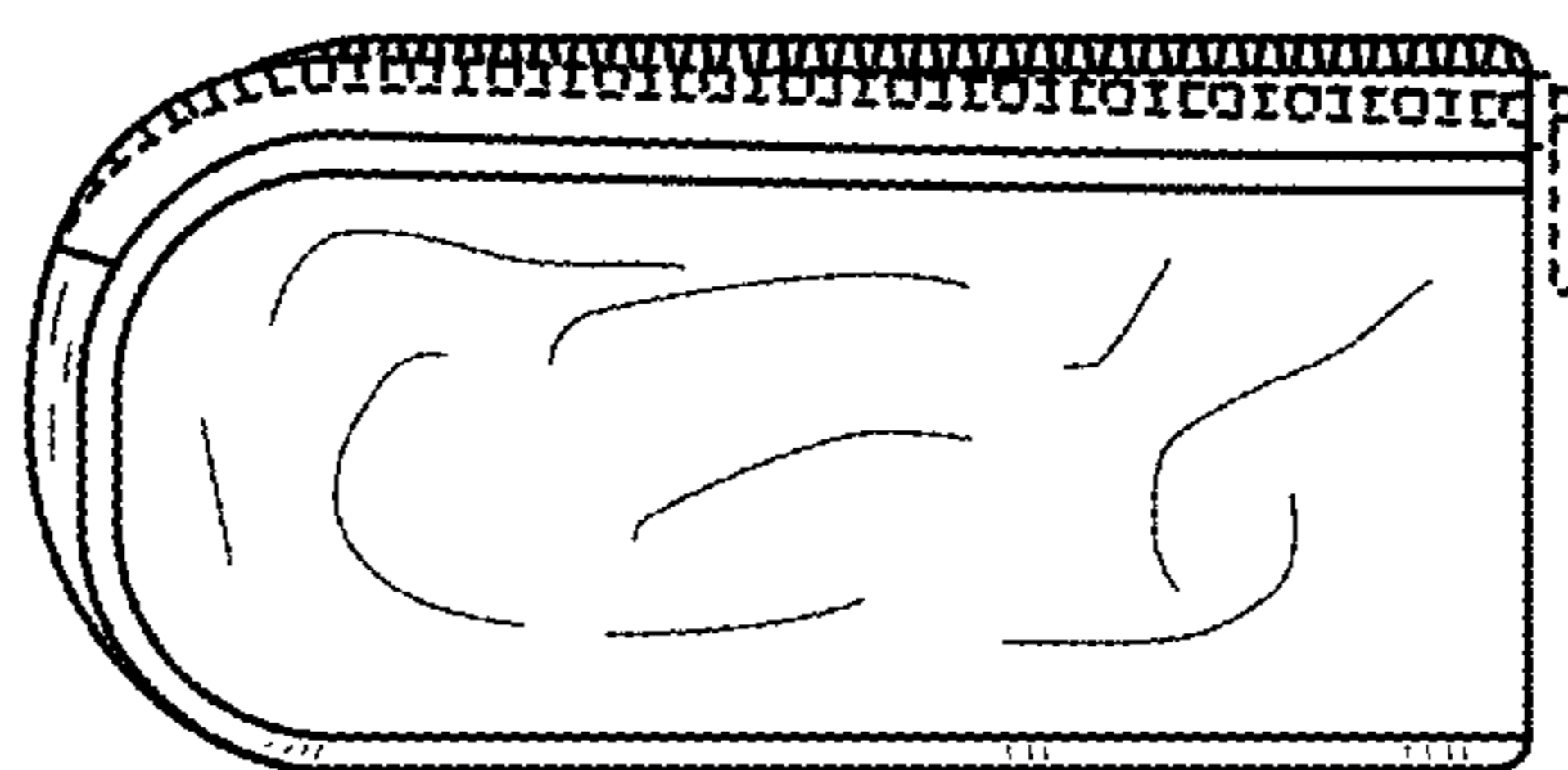

FIG. 21

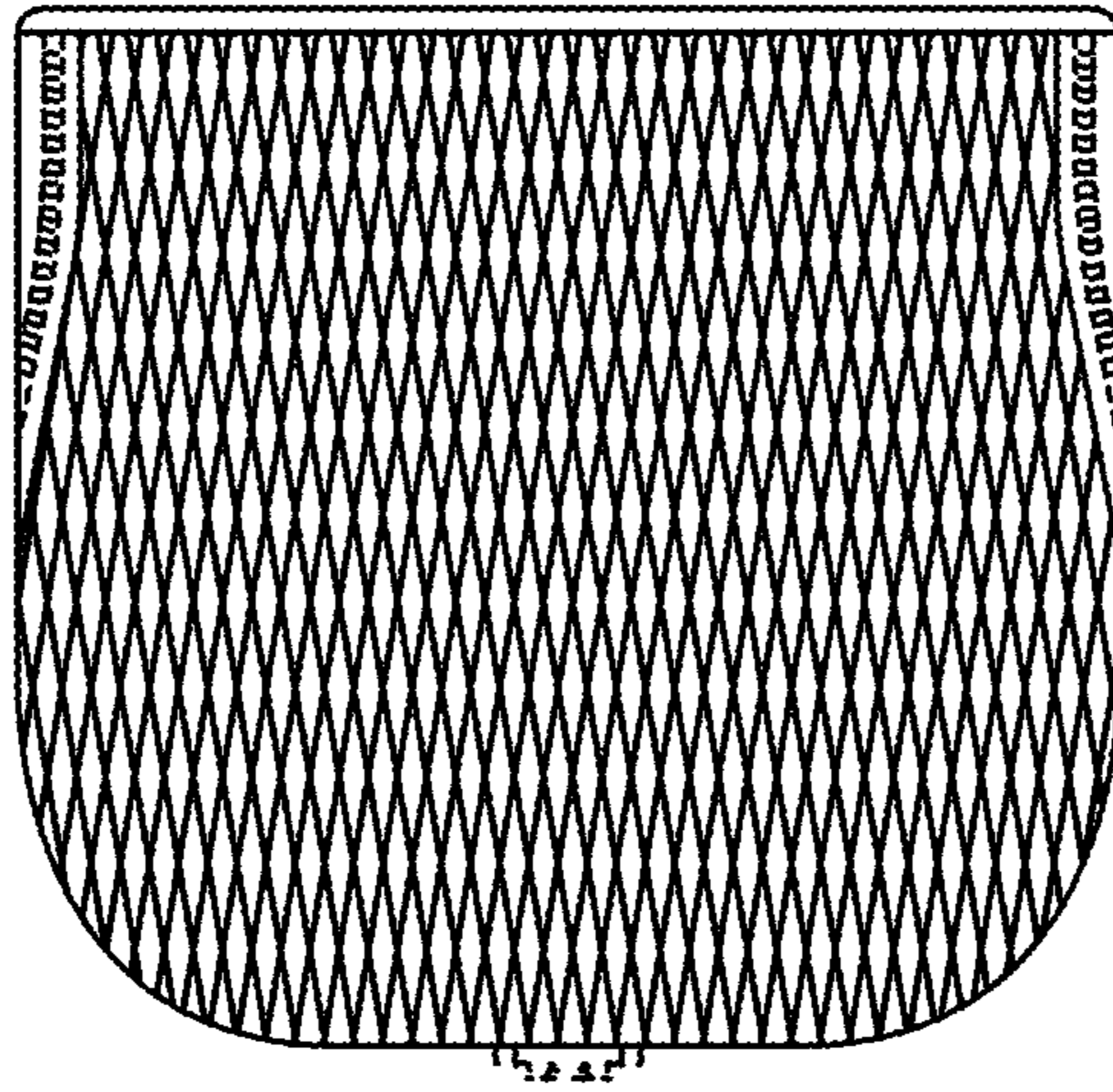

FIG. 22

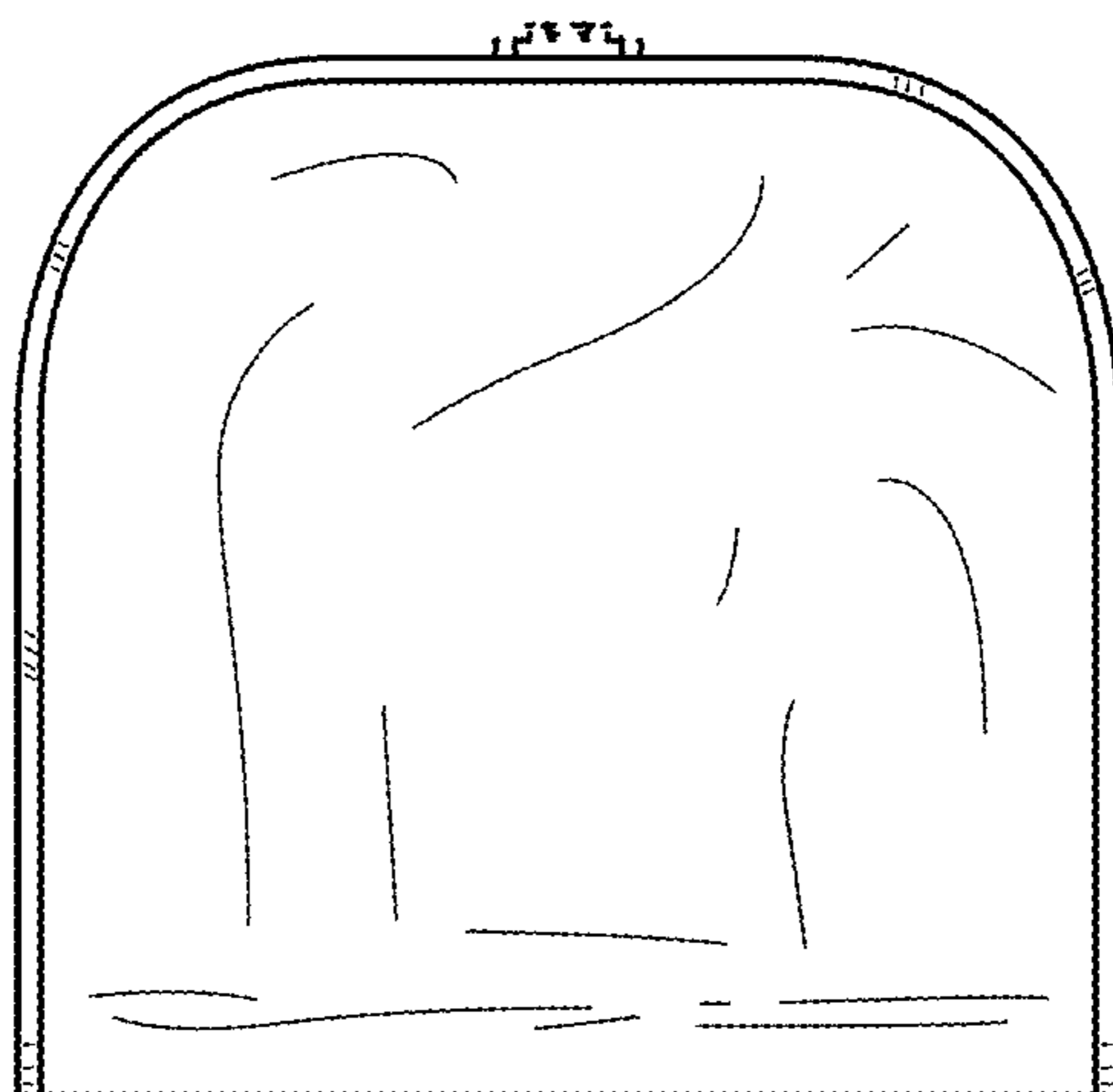

FIG. 23

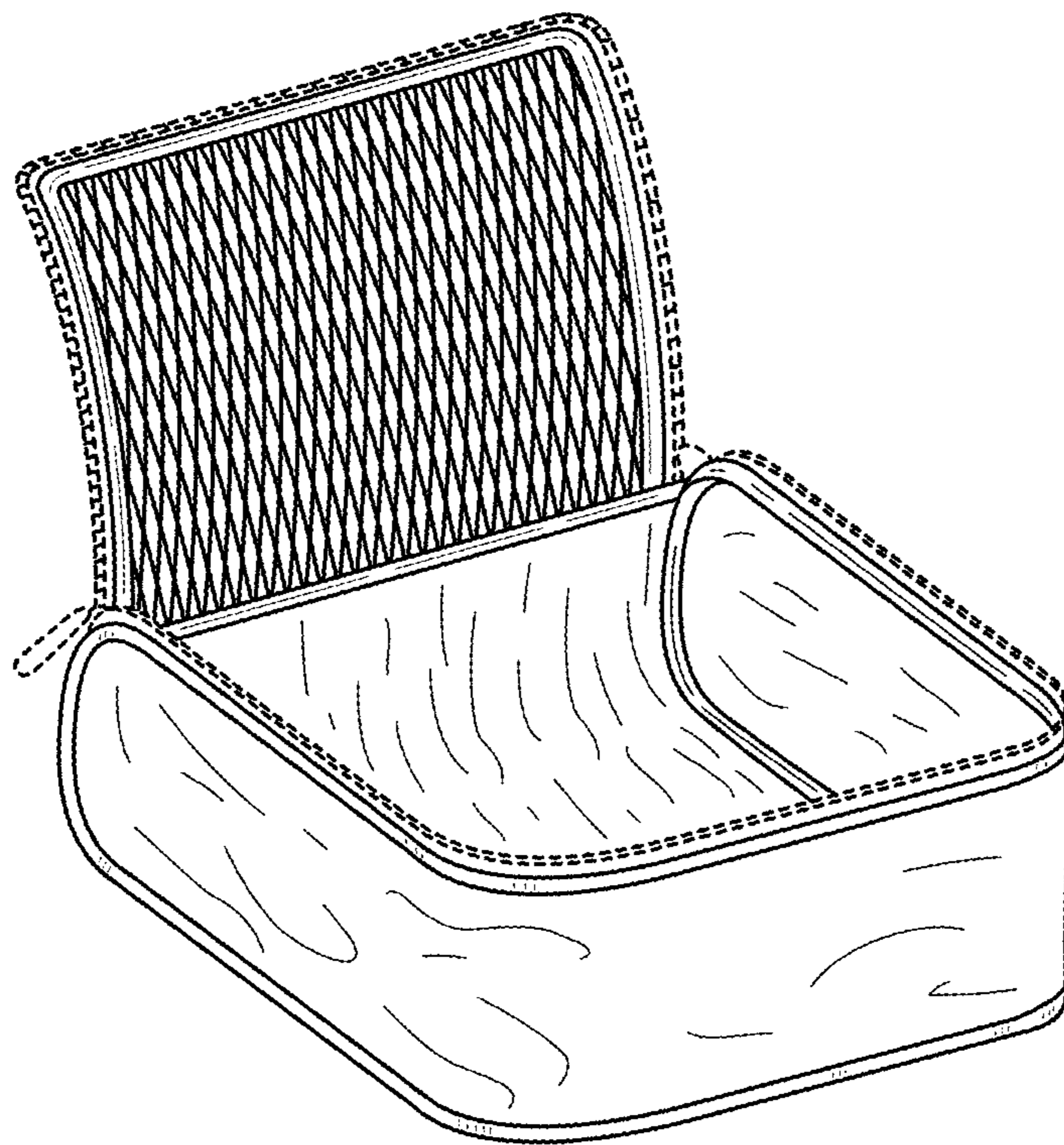

FIG. 24