



US00D816988S

(12) **United States Design Patent** (10) **Patent No.:** **US D816,988 S**
McLauchlin (45) **Date of Patent:** **** May 8, 2018**

(54) **BAG WITH COMBINATION ZIPPER LOCK**

D742,635 S * 11/2015 Coleman D3/232
D765,968 S * 9/2016 Becklund D3/232
2007/0240798 A1 10/2007 Bihler
2008/0060400 A1 3/2008 Ling et al.
2011/0142375 A1 6/2011 Lebow
2013/0091906 A1 4/2013 Chen

(71) Applicant: **Kenneth James McLauchlin**, St.
Catharines (CA)

(72) Inventor: **Kenneth James McLauchlin**, St.
Catharines (CA)

(**) Term: **15 Years**

(21) Appl. No.: **29/630,932**

(22) Filed: **Dec. 23, 2017**

(51) **LOC (11) Cl.** **03-01**

(52) **U.S. Cl.**
USPC **D3/232**

(58) **Field of Classification Search**
USPC D3/232, 245
CPC A45C 1/024; A45C 3/08
See application file for complete search history.

(56) **References Cited**

U.S. PATENT DOCUMENTS

| | | | | |
|-----------|-----|---------|------------------|--------|
| 4,031,723 | A | 6/1977 | Samhammer et al. | |
| D270,398 | S | 9/1983 | Stolarz | |
| D291,652 | S | 9/1987 | Gisiger | |
| 4,790,156 | A | 12/1988 | Yang | |
| 5,557,954 | A | 9/1996 | Ling | |
| D374,985 | S * | 10/1996 | Hoyt | D3/245 |
| 5,927,110 | A | 7/1999 | Yu | |
| 6,202,455 | B1 | 3/2001 | Su | |
| D449,216 | S | 10/2001 | Herda | |
| D480,621 | S | 10/2003 | Ling | |
| 6,912,880 | B2 | 7/2005 | Ling et al. | |
| 7,743,713 | B2 | 7/2010 | Volk et al. | |
| D663,117 | S * | 7/2012 | Schiffman | D3/232 |
| D695,011 | S * | 12/2013 | Morszeck | D3/247 |
| 8,661,861 | B2 | 3/2014 | Lai | |
| D728,223 | S | 5/2015 | Setre Shens | |
| D729,606 | S | 5/2015 | Thomson | |
| D729,607 | S | 5/2015 | Thomson | |
| 9,151,081 | B2 | 10/2015 | Thomson | |

OTHER PUBLICATIONS

Amazon Listing Link: https://images-na.ssl-images-amazon.com/images/I/71RJ0dtIO%2BL_SL1500_.jpg Date: Oct. 26, 2017.

(Continued)

Primary Examiner — Holly H Baynham

(74) *Attorney, Agent, or Firm* — Reem Allos

(57) **CLAIM**

The ornamental design for a bag with combination zipper lock, as shown and described.

DESCRIPTION

FIG. 1 is a perspective view of the bag with combination zipper lock showing an embodiment of the new design; FIG. 2 is a front view thereof; FIG. 3 is a back view thereof; FIG. 4 is a right-side view thereof; FIG. 5 is a left-side view thereof; FIG. 6 is a top view thereof; FIG. 7 is a bottom view thereof; and, FIG. 8 is an alternative front view of the bag with combination zipper lock shown with the zipper open. The dashed lines along the perimeter of the zipper portion are understood to represent stitching. The dot-dash lines forming a handle along the side of the claimed design are understood to be for the purposes of illustrating environment and form no part of the claimed design.

1 Claim, 6 Drawing Sheets

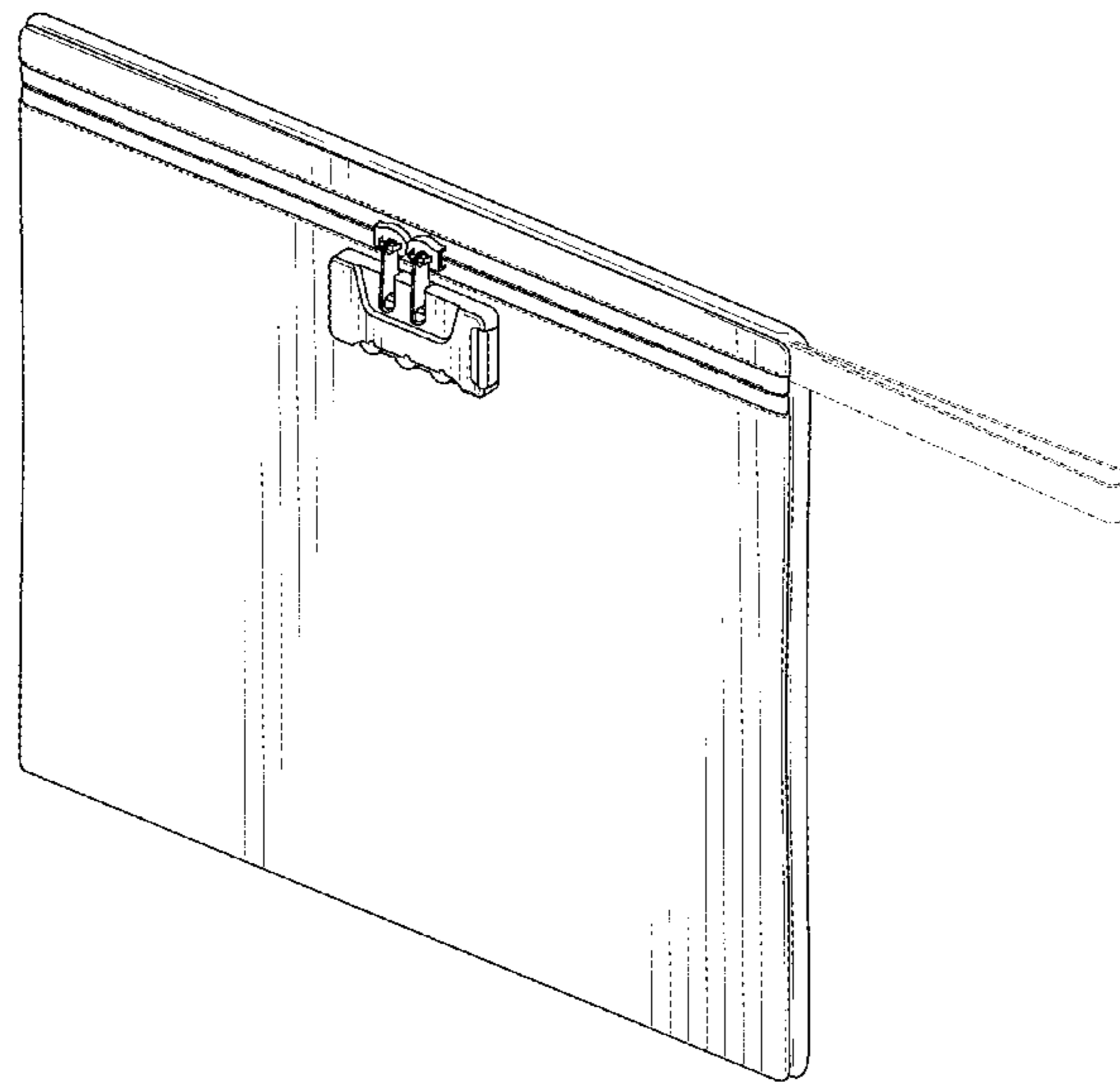

(56)

References Cited

OTHER PUBLICATIONS

Mermaid Combination Lock Cosmetics box—Medicine Cabinet Coded Locks Storage Box with Separate Compartments, Cosmetic, Toiletries, Pill Storage Containers, Size 11" x7.4" x6.2" (Cyan) Date: Oct. 26, 2017 https://www.amazon.com/Mermaid-Combination-box-Medicine-Compartments-Toiletries/dp/B01MXC0KB6/ref=sr_1_7_a_it?ie=UTF8&qid=1509043547&sr=8-7&keywords=makeup%2Bcase%2Bwith%2Block&th=1.

TSA Approved Travel Combination Cable Luggage Locks for Suitcases—1, 2, 4 & 6 Pack Date: Oct. 26, 2017 https://www.amazon.com/Approved-Combination-Luggage-Suitcases-Backpacks/dp/B0186QMA2U/ref=sr_1_3_mc?s=apparel&ie=UTF8&qid=1509043698&sr=1-3&keywords=bag+with+lock.

Travelambo Business Water Resistant Polyester Laptop Backpack Travel Bag with USB Charging Port and Lock Fits Under 17-Inch Laptop and Notebook (gray) Date: Oct. 26, 2017 https://www.amazon.com/Travelambo-Business-Resistant-Polyester-Backpack/dp/B0756PD6DR/ref=sr_1_6?s=apparel&ie=UTF8&qid=1509043791&sr=1-6&nodeID=7141123011&psd=1&keywords=bag+with+lock.

Vaultz® Locking Zipper Pouch, 5" x8", Black (VZ00472) Date: Oct. 26, 2017 <https://www.quill.com/vaultz-locking-zipper-pouch->

5-x-8-black-vz00472/cbs/52478341.html?hidedisruptive=1&cm_mmc=SEM_PLA_OS_52478341&mcode=SEM_PLA_OS_52478341&gclid=CjwKCAjwj8bPBRBiEiwASIFLfdTHvjz7U9hR5w8769-CBZ-fhz-VRaHwv16ryPIIXqzIdjB2ENnKFGBoCNBgQAvD_BwE&gclsrc=aw.ds.

Digipas's eGeeTouch® Smart NFC—Fingerprint Luggage Locks named as 2016 CES Innovation Awards Honoree Date: Oct. 26, 2017 <http://www.egeetouch.com/news-events/ces-unveiled-las-vegas-2016>.

CES Innovation Award <https://www.egeetouch.com/images/social/ces2016-winner.jpg> Date: Oct. 26, 2017.

Smart Luggage Zipper Lock Module <https://www.egeetouch.com/images/slide/luggage-module.jpg> Date: Oct. 26, 2017.

Skunk Sidekick Smell Proof Case w/ Combo LockNEW Collection https://www.amazon.com/Skunk-Sidekick-Smell-LockNEW-Collection/dp/B071WWKNN2/ref=pd_sim_201_5?_encoding=UTF8&psc=1&refRID=QHT1H5GJFD11FXVZ7AK5 Date: Oct. 26, 2017.

Skunk Duffle bag Small 10"—Smell Proof—With combo lock—New Collection https://www.amazon.com/Skunk-Duffle-Small-Smell-Proof/dp/B073T465FJ/ref=pd_sim_468_3?_encoding=UTF8&refRID=N5Q0WKPMSRXZ9V3WN5NP Date: Oct. 26, 2017.

* cited by examiner

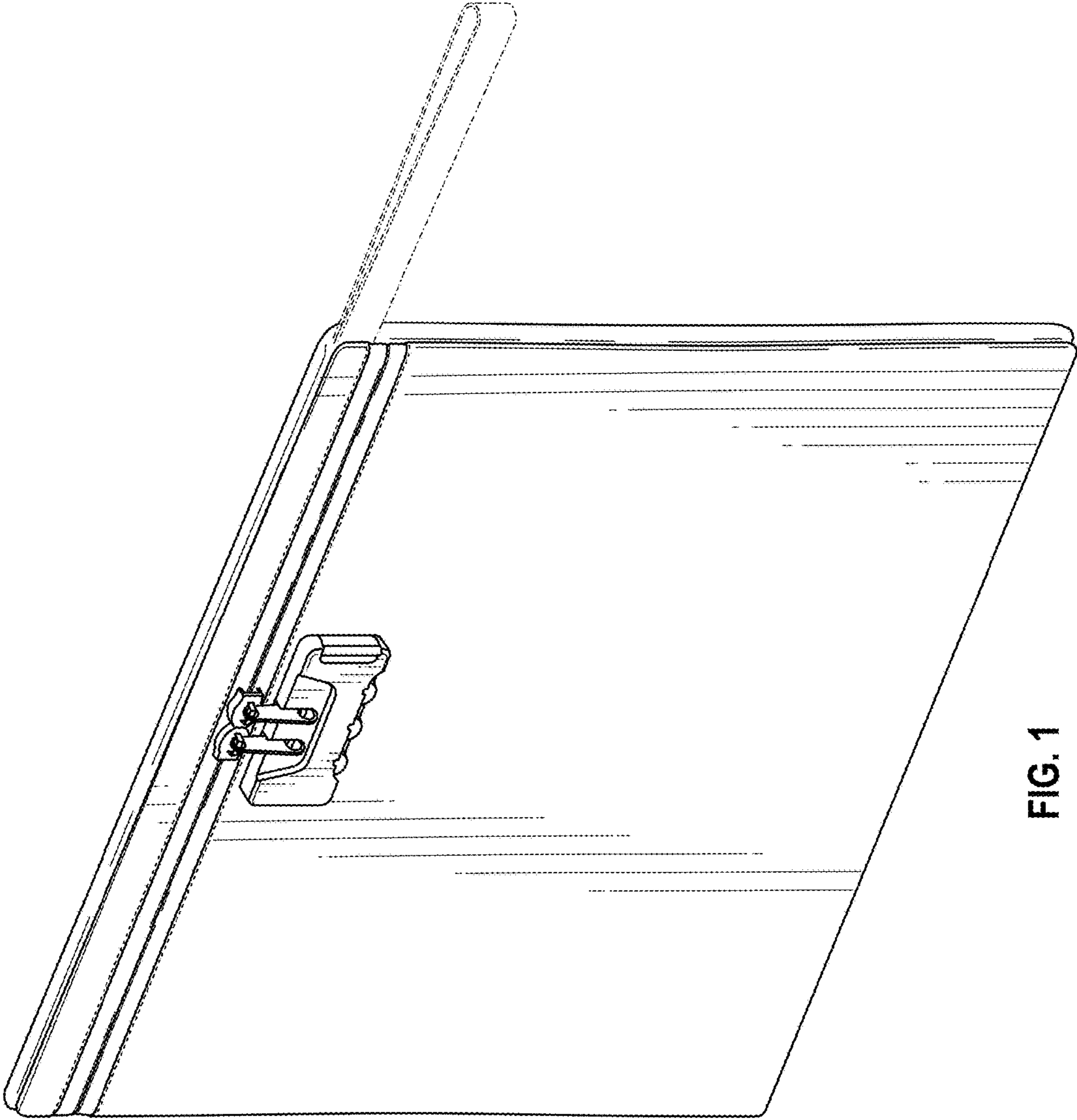

FIG. 1

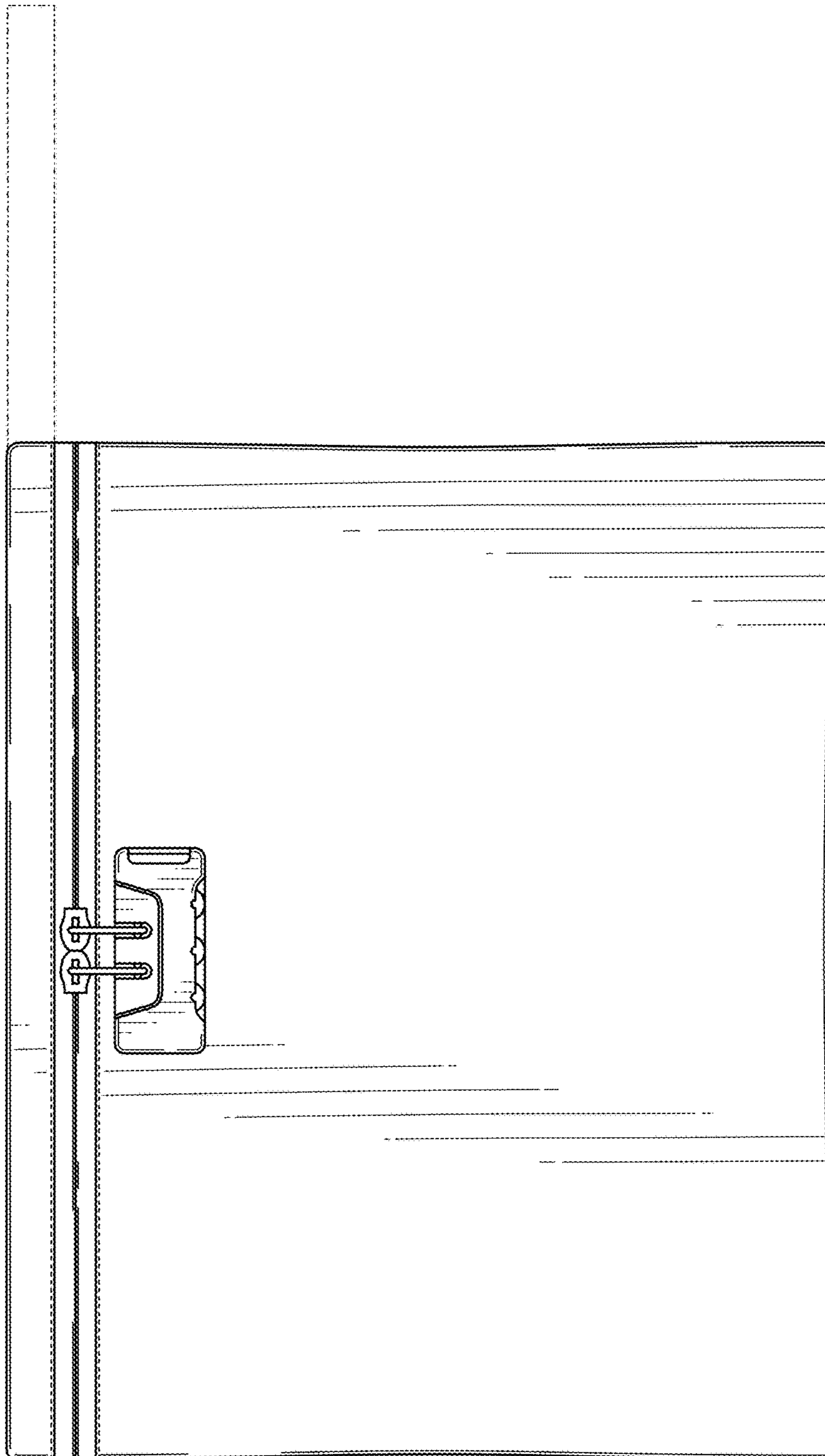

FIG. 2

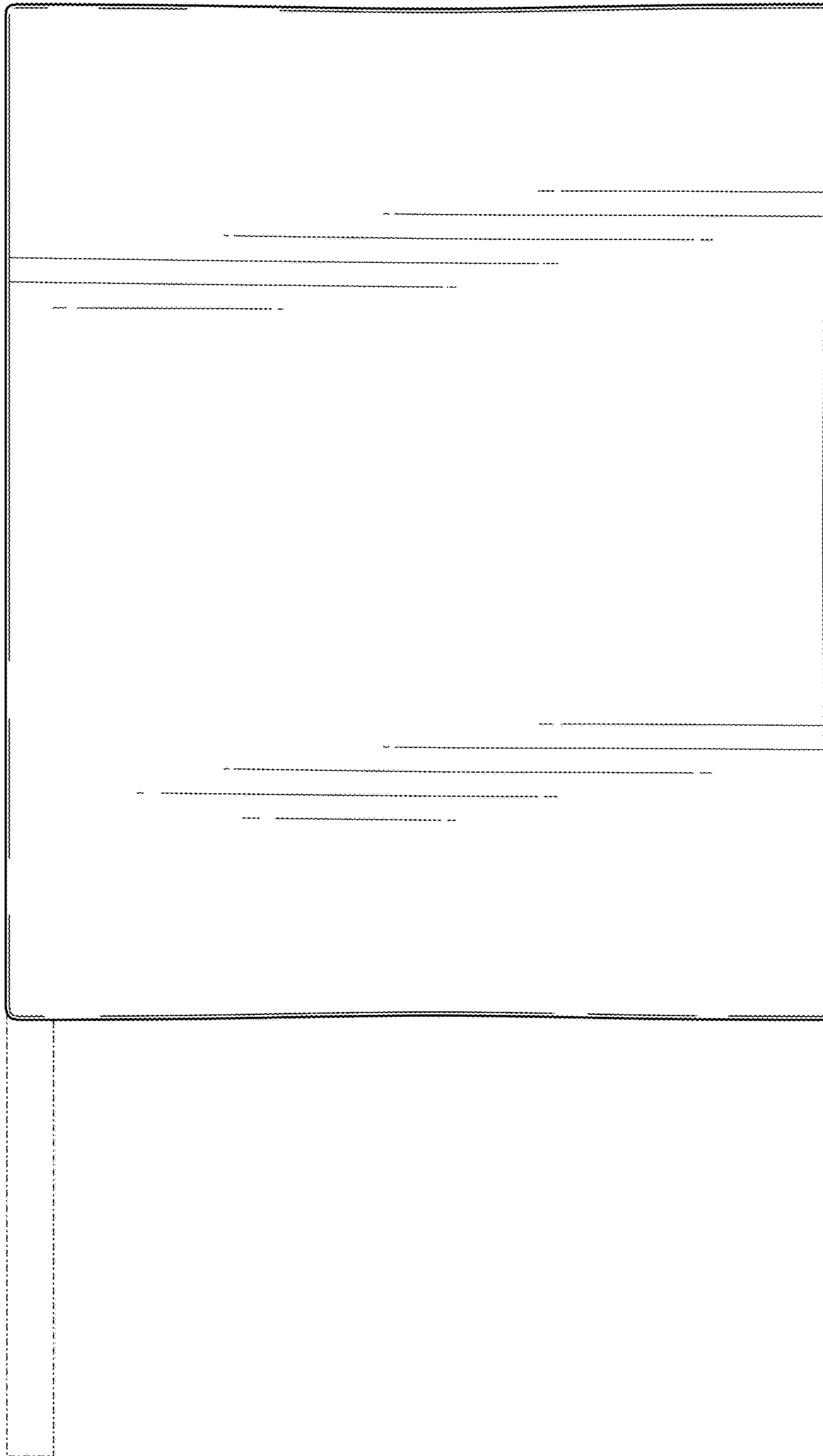

FIG. 3

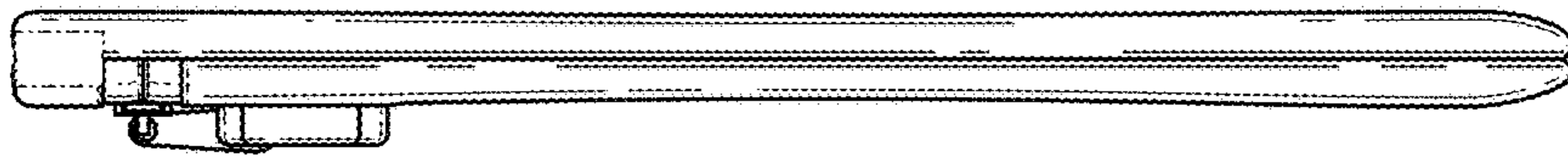

FIG. 5



FIG. 4

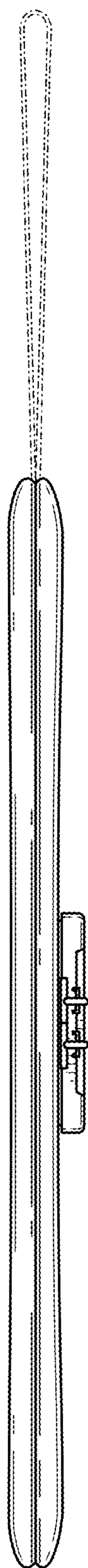

FIG. 6



FIG. 7

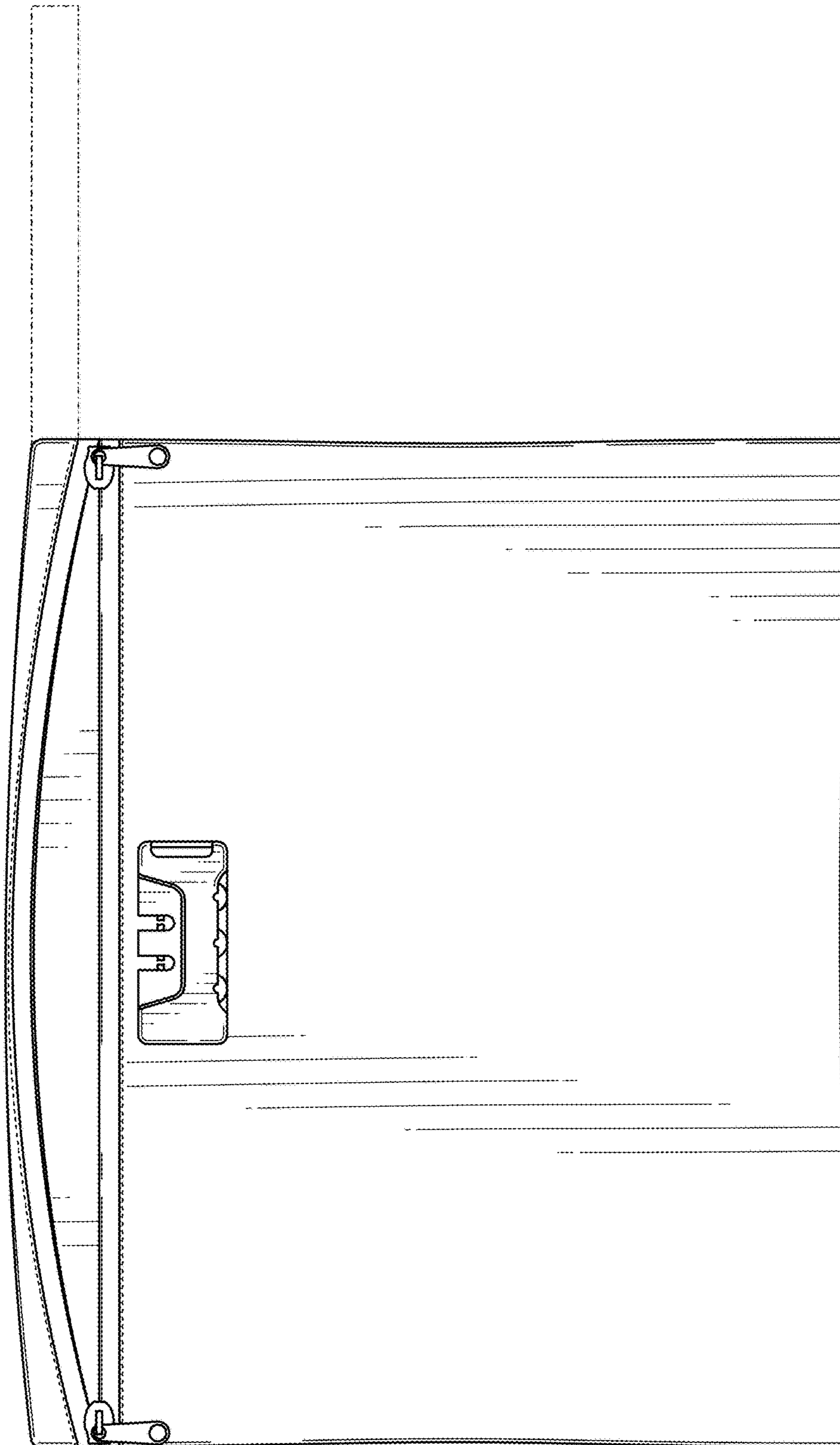

FIG. 8