



US00D816746S

(12) **United States Design Patent**
Liu

(10) **Patent No.:** **US D816,746 S**

(45) **Date of Patent:** **** May 1, 2018**

(54) **AUTO-DARKENING WELDING FILTER**

(71) Applicant: **Antra Technologies Co., Ltd, Wuxi (CN)**

(72) Inventor: **Kailiang Liu, Wuxi (CN)**

(73) Assignee: **ANTRA TECHNOLOGIES CO., LTD., Wuxi (CN)**

(**) Term: **15 Years**

(21) Appl. No.: **29/552,732**

(22) Filed: **Jan. 25, 2016**

(30) **Foreign Application Priority Data**

Dec. 3, 2015 (CN) 2015 3 04991827

(51) **LOC (11) Cl.** **29-02**

(52) **U.S. Cl.**
USPC **D15/144; D29/110**

(58) **Field of Classification Search**
USPC 15/144, 144.1, 144.2; 29/100, 101.1, 29/102, 104-110, 122
CPC A61F 9/067
See application file for complete search history.

(56) **References Cited**

U.S. PATENT DOCUMENTS

- 4,617,033 A * 10/1986 Strang B03C 1/30
219/137.41
- D322,493 S * 12/1991 Metzger D29/110
- D324,588 S * 3/1992 Metzger D29/110
- D349,588 S * 8/1994 Howard D15/144.1
- D353,692 S * 12/1994 Ferguson D16/134
- D482,502 S * 11/2003 Huh D29/110

- D678,619 S * 3/2013 Jackson D29/110
- D683,502 S * 5/2013 Jackson D29/110
- 8,990,963 B2 * 3/2015 Matthews A61F 9/061
2/8.2
- 2004/0178326 A1 * 9/2004 Hamilton A61F 9/06
250/214 R
- 2005/0057544 A1 * 3/2005 Hamilton G01J 1/26
345/204
- 2013/0097760 A1 * 4/2013 Feinberg G02B 7/006
2/8.2

* cited by examiner

Primary Examiner — Patricia A Palasik

(74) *Attorney, Agent, or Firm* — Gokalp Bayramoglu

(57) **CLAIM**

The ornamental design for an auto-darkening welding filter, as shown and described.

DESCRIPTION

FIG. 1 is a perspective view of an auto-darkening welding filter;
 FIG. 2 is a front view of the auto-darkening welding filter;
 FIG. 3 is a rear view of the auto-darkening welding filter;
 FIG. 4 is a left side view of the auto-darkening welding filter;
 FIG. 5 is a right side view of the auto-darkening welding filter;
 FIG. 6 is a top view of the auto-darkening welding filter;
 and,
 FIG. 7 is a bottom view of the auto-darkening welding filter.
 The broken lines in the drawings depict unclaimed environmental subject matter.

1 Claim, 7 Drawing Sheets

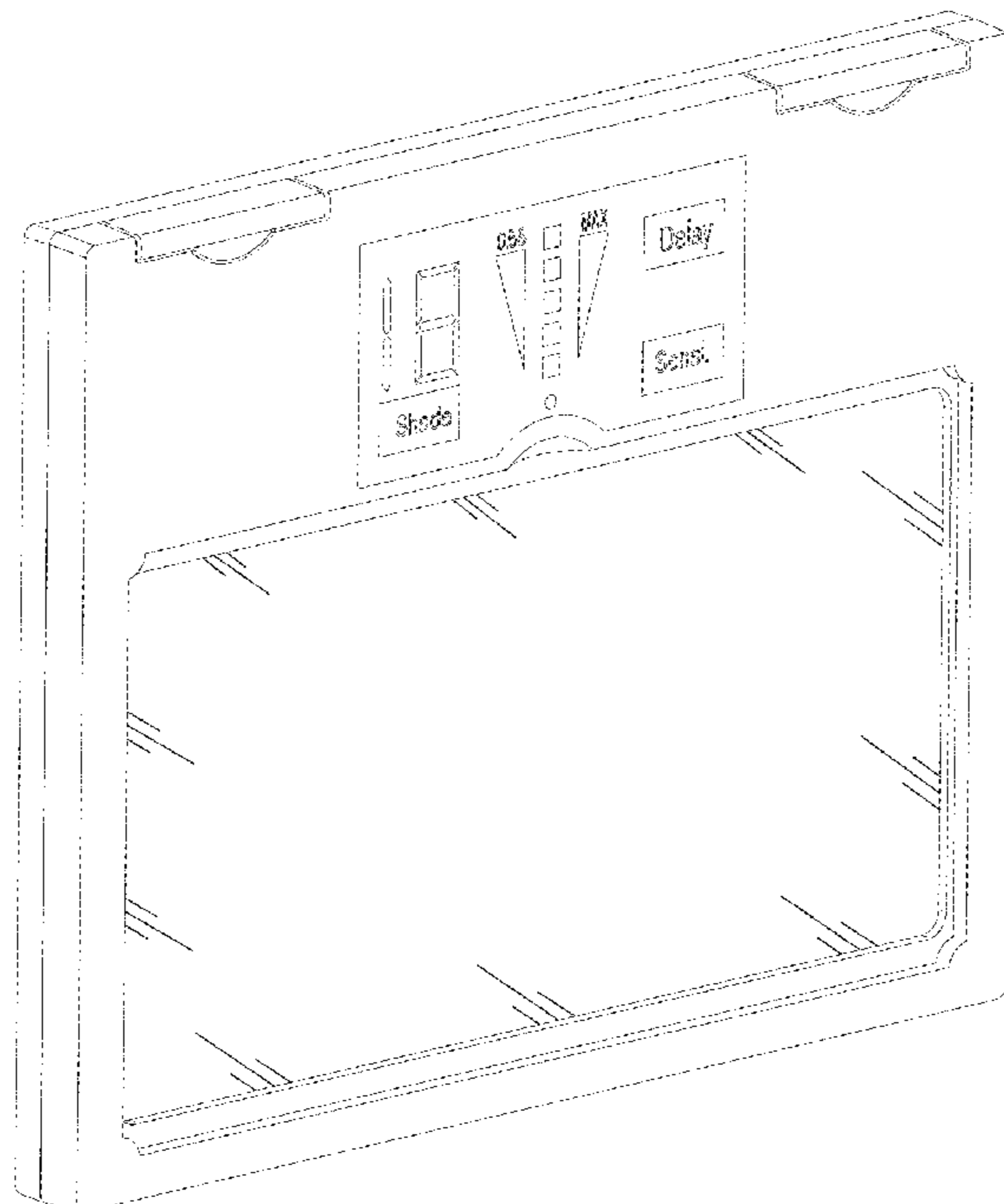

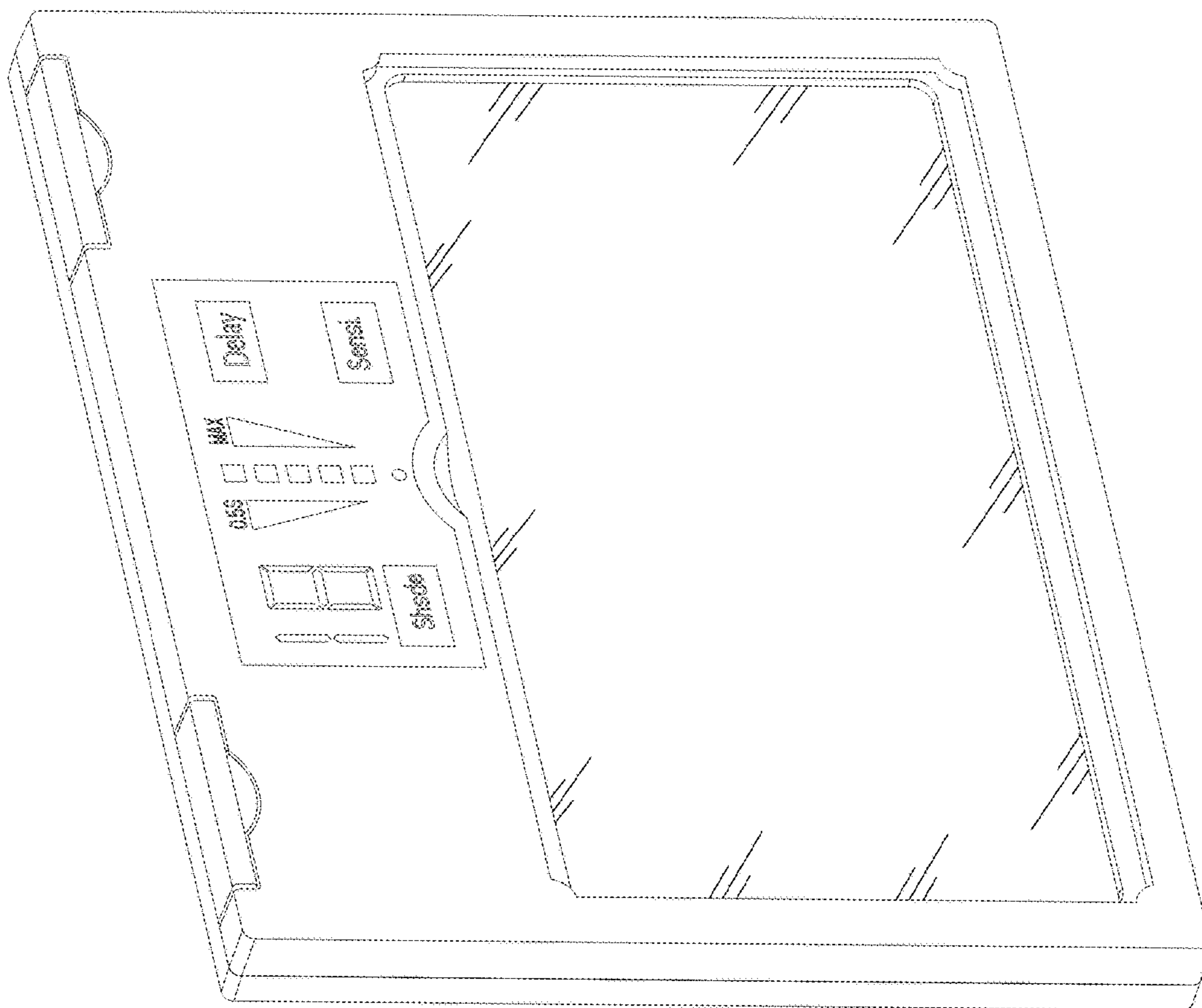

FIG. 1

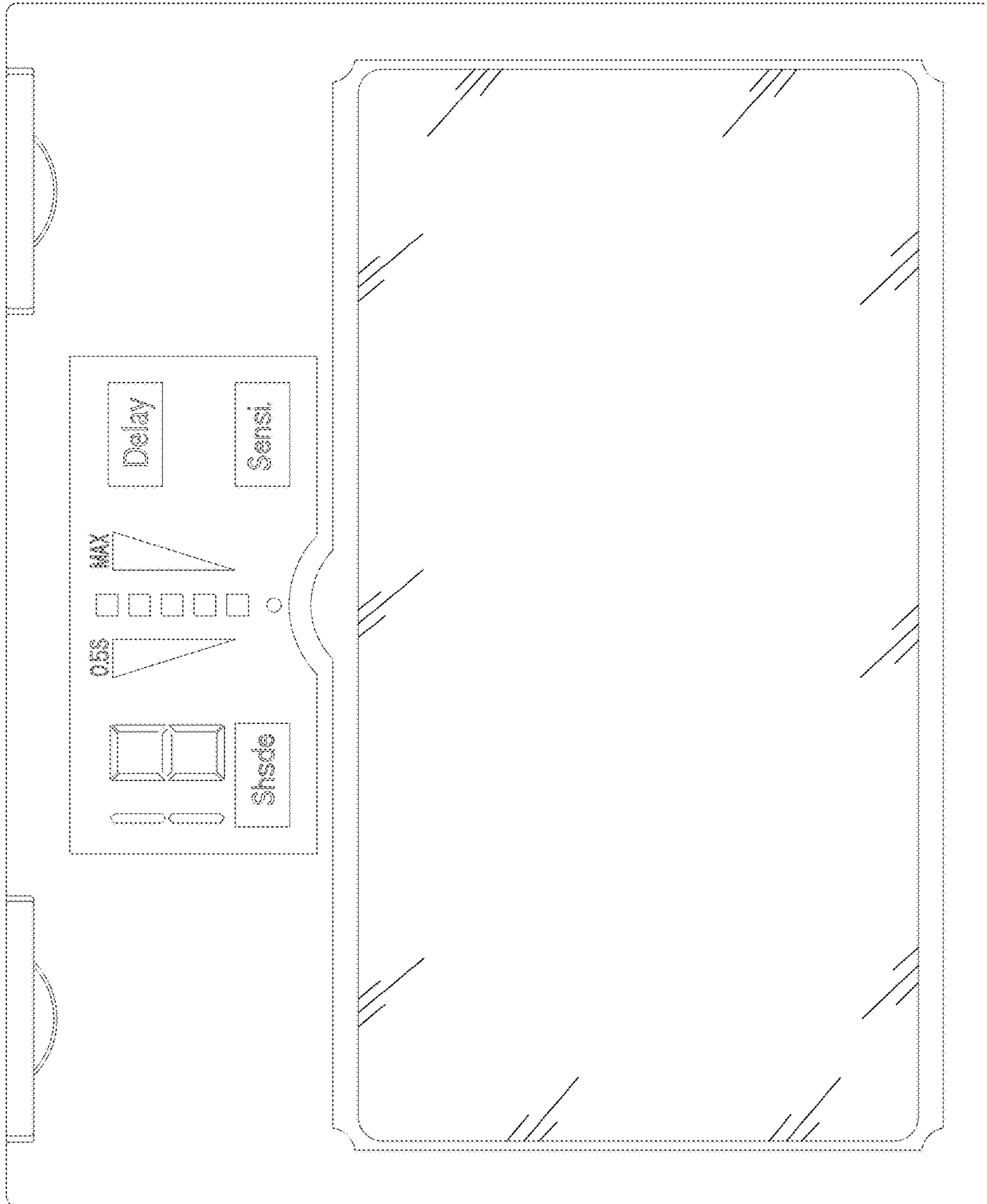

FIG. 2

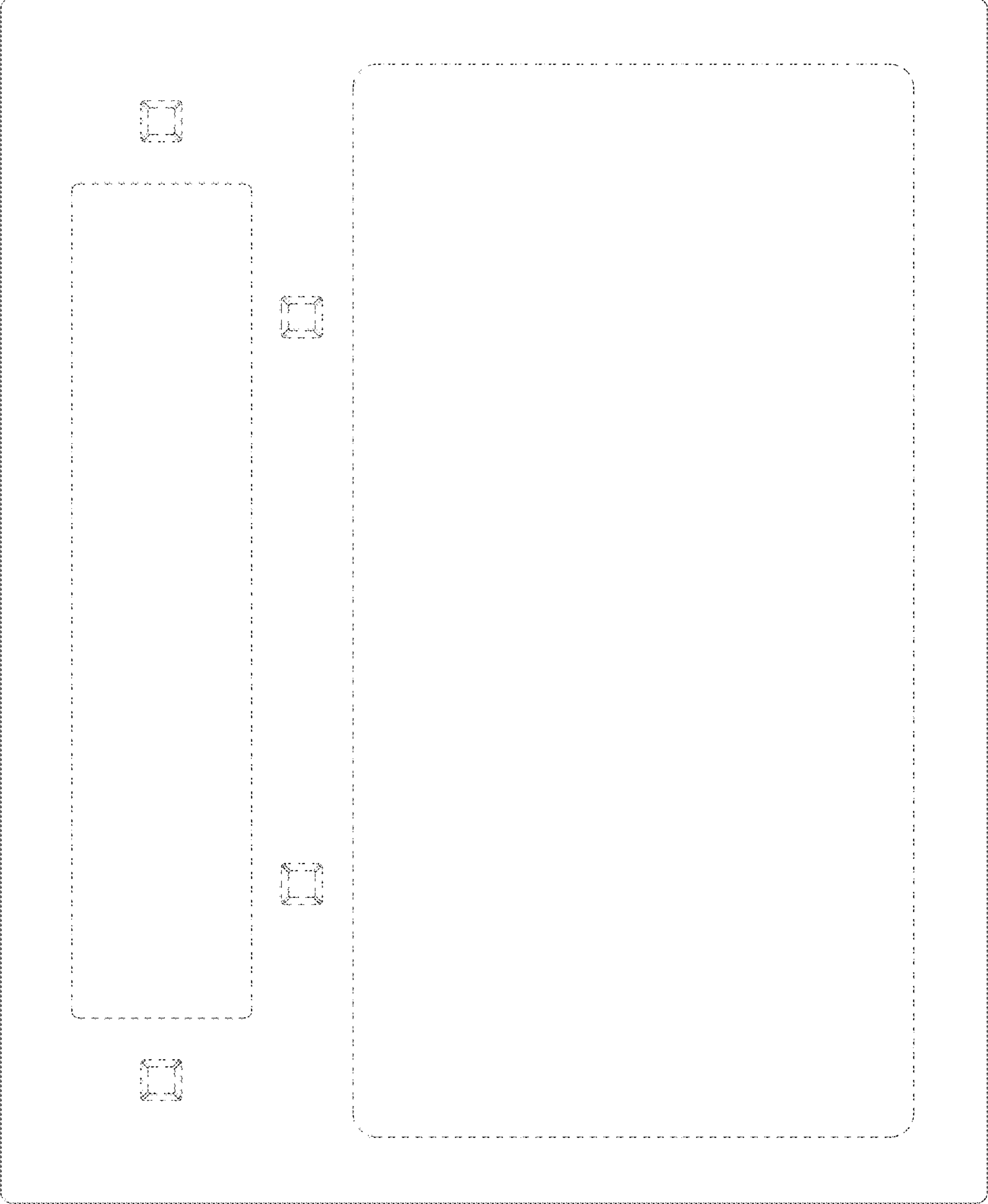

FIG.3

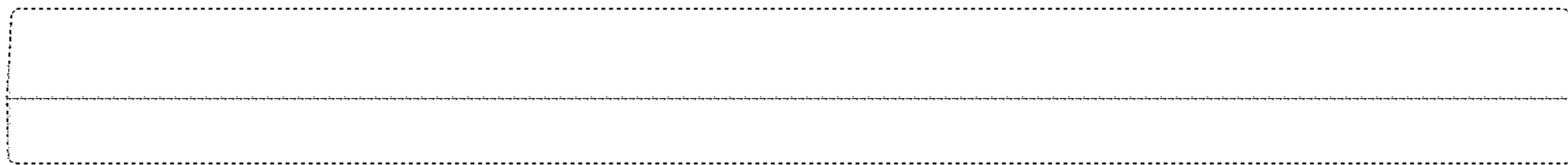

FIG.4

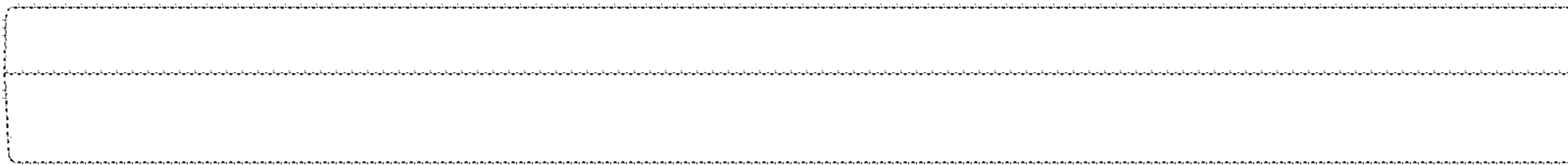

FIG. 5

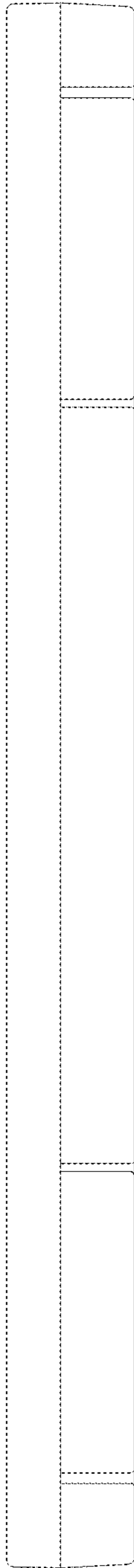

FIG.6

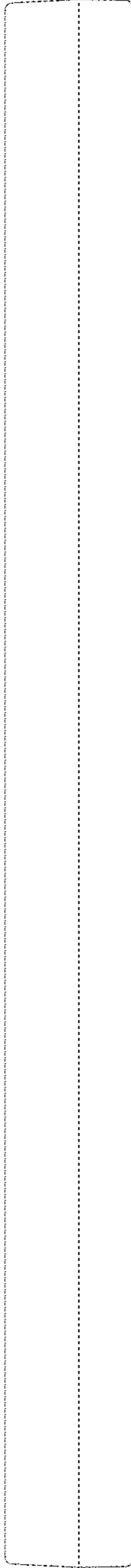

FIG.7