



US00D816720S

(12) **United States Design Patent**
Winter et al.

(10) **Patent No.:** **US D816,720 S**

(45) **Date of Patent:** **** May 1, 2018**

- (54) **PUSHER PLOW BLADE SYSTEM**
- (71) Applicant: **Winter Equipment Copmany,**
Willoughby, OH (US)
- (72) Inventors: **Kent Winter,** Willoughby, OH (US);
William A. Sulesky, Medina, OH (US)
- (73) Assignee: **WINTER EQUIPMENT COMPANY,**
Willoughby, OH (US)

- 2,460,348 A * 2/1949 Henry E02F 3/8157
172/832
- 2,593,025 A * 4/1952 Hanson B62B 15/00
280/28
- 3,685,177 A 8/1972 Hahn et al.
- 4,441,266 A 4/1984 Westimayer
- 4,500,766 A * 2/1985 Reinhardt B23K 11/00
172/719
- D291,654 S * 9/1987 Foster, Jr. 280/28

(**) Term: **15 Years**

(21) Appl. No.: **29/602,215**

(22) Filed: **Apr. 28, 2017**

Primary Examiner — Mark Goodwin

(74) *Attorney, Agent, or Firm* — Fay Sharpe LLP

Related U.S. Application Data

- (63) Continuation-in-part of application No. 14/847,960,
filed on Sep. 8, 2015, now Pat. No. 9,708,784.
- (60) Provisional application No. 62/046,385, filed on Sep.
5, 2014.
- (51) **LOC (11) Cl.** **15-03**
- (52) **U.S. Cl.**
USPC **D15/11; D15/28**
- (58) **Field of Classification Search**
USPC D15/11, 21, 28, 32; 37/270; 280/28
CPC E01H 5/06–5/062; E01H 5/066; E01H
5/065; E01H 5/12; E01H 5/04; E02F
3/76–3/848; E02F 3/08; E02F 3/8157;
E02F 3/8152; B62B 15/00
See application file for complete search history.

(56) **References Cited**

U.S. PATENT DOCUMENTS

- 1,581,414 A * 4/1926 Young E02F 3/8157
172/393
- 1,713,882 A * 5/1929 Shaw E02F 3/8157
280/28
- 2,202,309 A * 5/1940 Campbell B62B 19/00
280/28

(57) **CLAIM**

The ornamental design for a pusher plow blade system, as shown and described.

DESCRIPTION

FIG. 1 is a perspective view of a pusher plow blade system showing our new design, the system composed of a side adapter blade and a modular array of skid shoes mounted thereto shown in assembled condition; FIG. 2 is a side elevational view thereof; FIG. 3 is a front elevational view of the side adapter blade shown unassembled for ease of illustration; FIG. 4 is a rear elevational view thereof; FIG. 5 is a cross-sectional view thereof taken along lines 5-5 in FIG. 3; FIG. 6 is a partial cross-sectional side elevational view of the frame shoe shown unassembled for ease of illustration; FIG. 7 is a partial cross-sectional front view thereof; FIG. 8 is a bottom plan view thereof; FIG. 9 is a partial cross-sectional side elevational view of a fore and aft skid shoe shown unassembled for ease of illustration; FIG. 10 is a top plan view thereof; and, FIG. 11 is a front elevational view thereof. The broken line showing of a blade is included for the purpose of illustrating environmental structure only and forms no part of the claimed design.

1 Claim, 6 Drawing Sheets

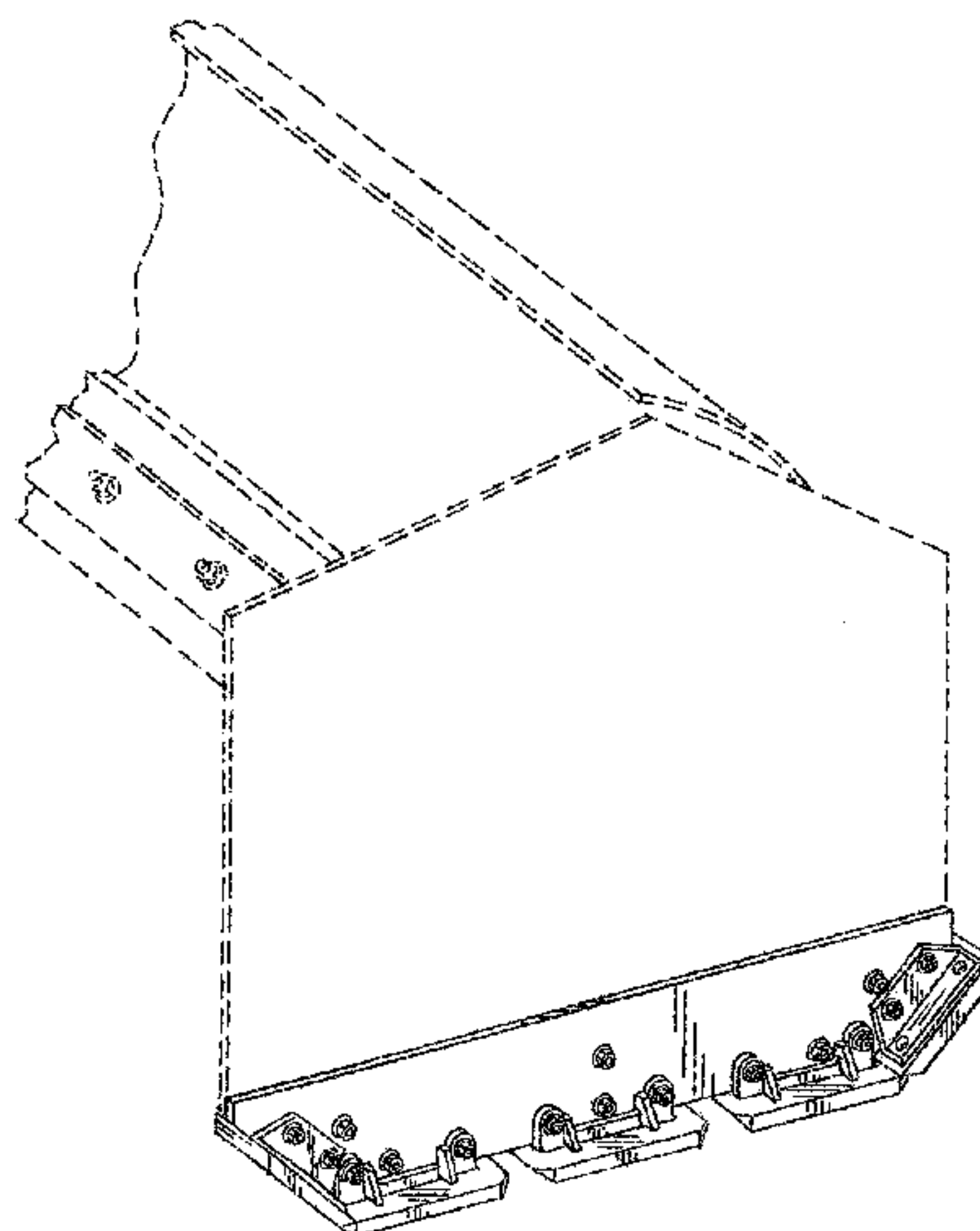

(56)

References Cited

U.S. PATENT DOCUMENTS

5,148,616	A	9/1992	Maguina-Larco	
5,553,409	A	9/1996	Irving	
5,724,755	A	3/1998	Weagley	
6,041,529	A	3/2000	Ruvang	
6,792,704	B2	9/2004	Johnson	
7,100,314	B1	9/2006	Jensen	
7,266,914	B2	9/2007	Grant	
7,596,895	B2	10/2009	Jones	
7,836,615	B2	11/2010	Winter	
7,874,085	B1	1/2011	Winter et al.	
8,024,874	B2	9/2011	McClanahan et al.	
8,191,287	B2	6/2012	Winter et al.	
8,544,856	B2	10/2013	Sayre	
8,844,173	B2	9/2014	Winter et al.	
9,163,379	B2	10/2015	Winter	
9,428,874	B2 *	8/2016	Winter	E01H 5/061
9,562,342	B2 *	2/2017	Winter	E02F 3/8157
9,708,784	B2 *	7/2017	Winter	E01H 5/066
D799,554	S *	10/2017	Peterson	D15/11
2005/0126051	A1	6/2005	Fatemi	
2012/0260537	A1	10/2012	Winter et al.	
2015/0047234	A1	2/2015	Winter	
2016/0010314	A1	1/2016	Kassander	

* cited by examiner

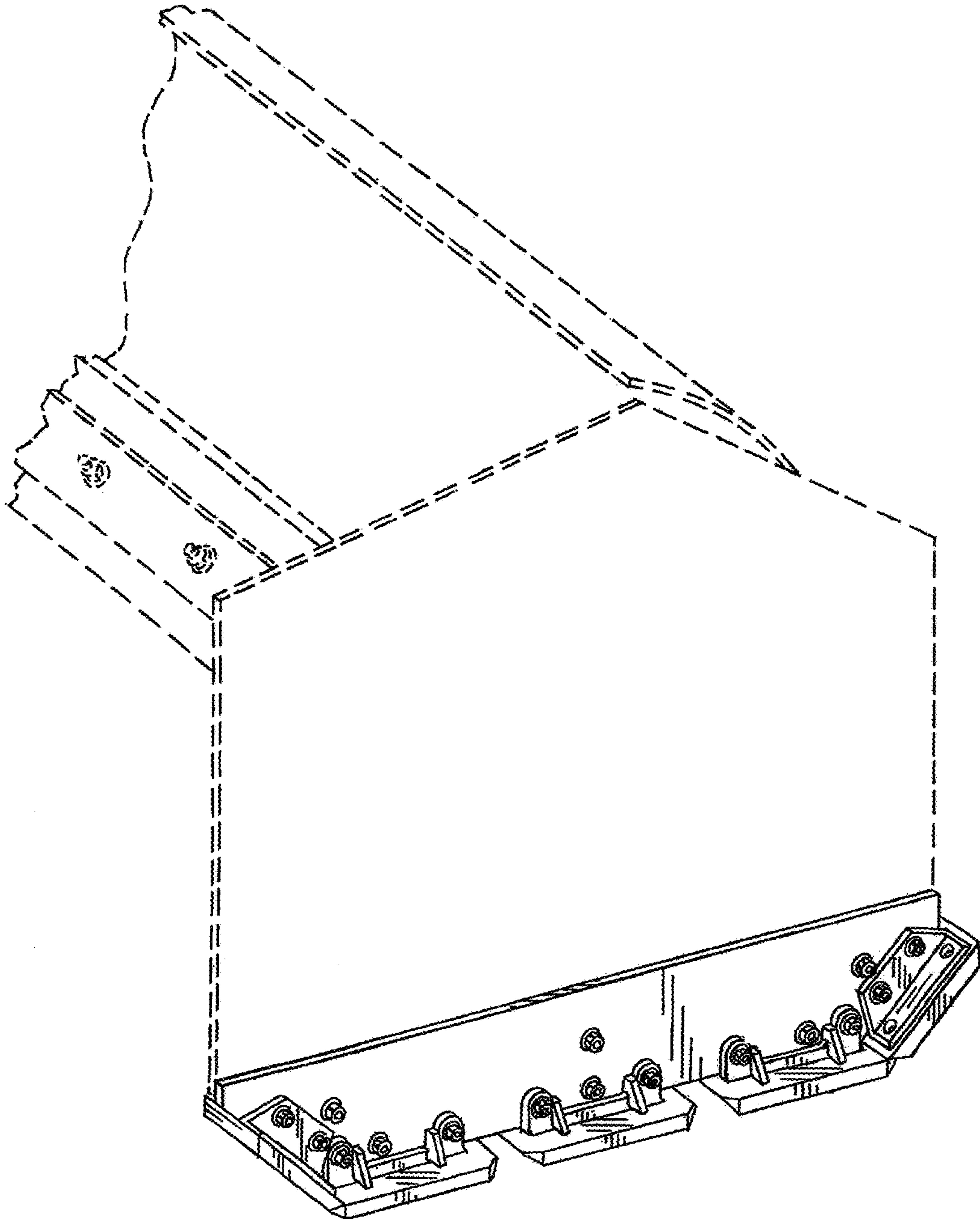

FIG. 1

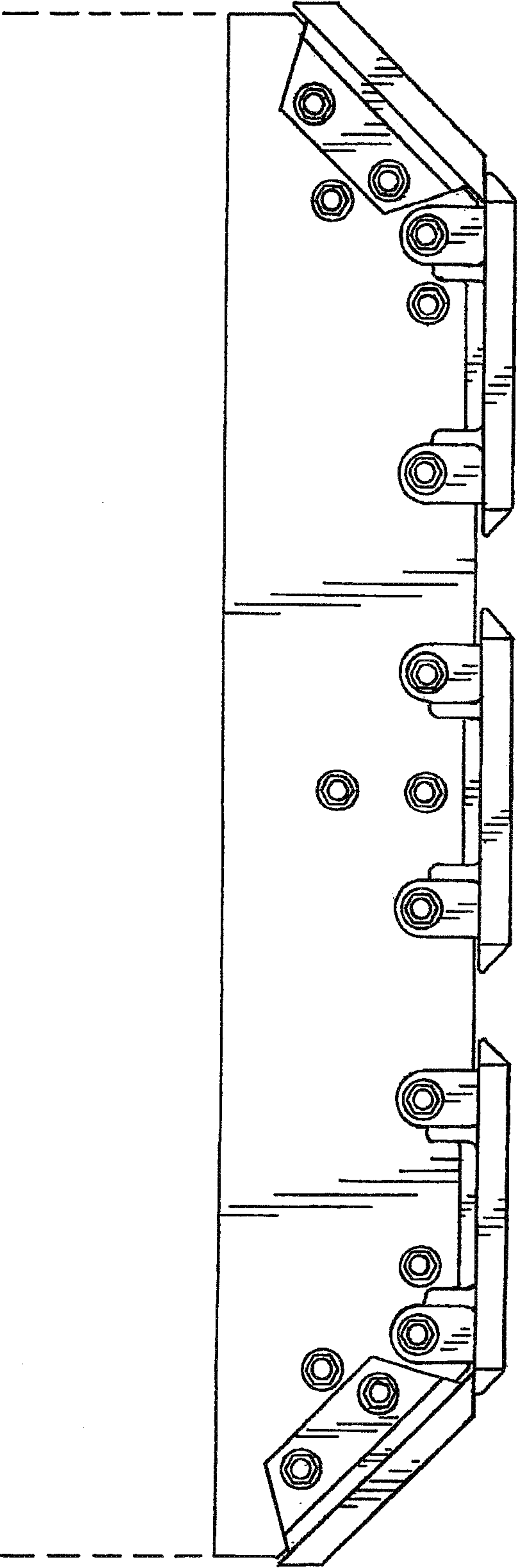
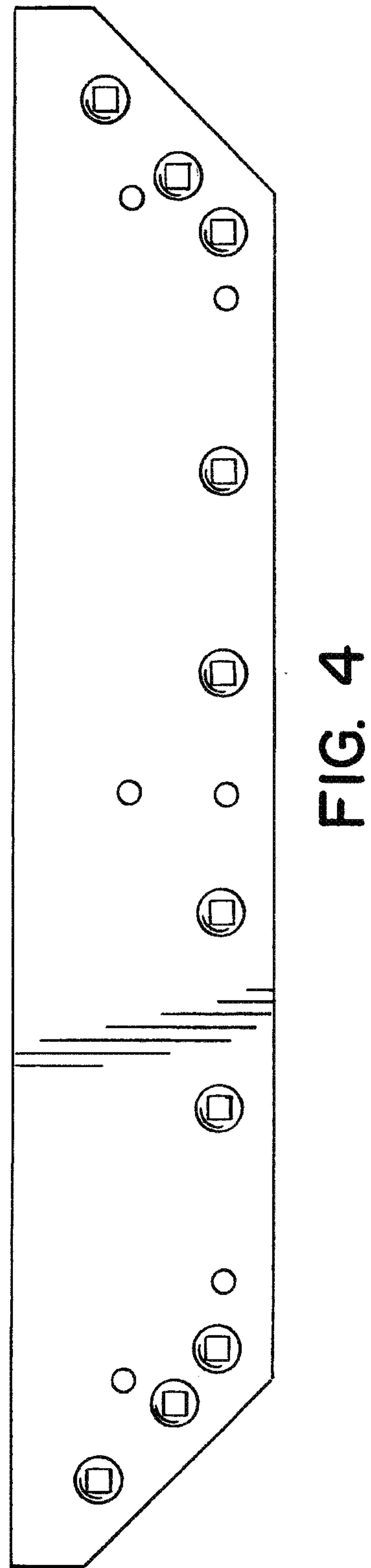
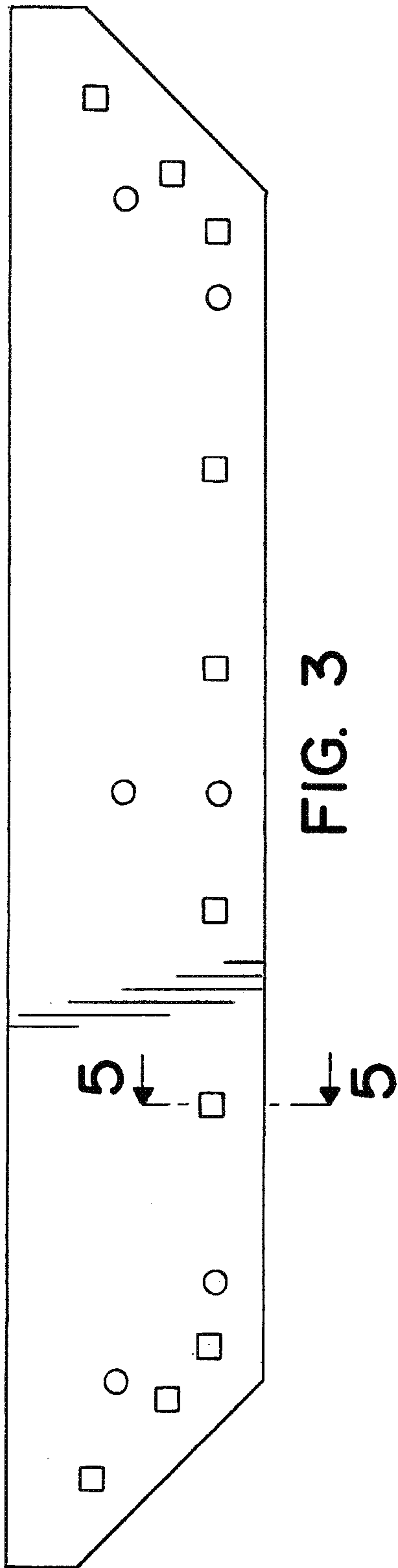

FIG. 2



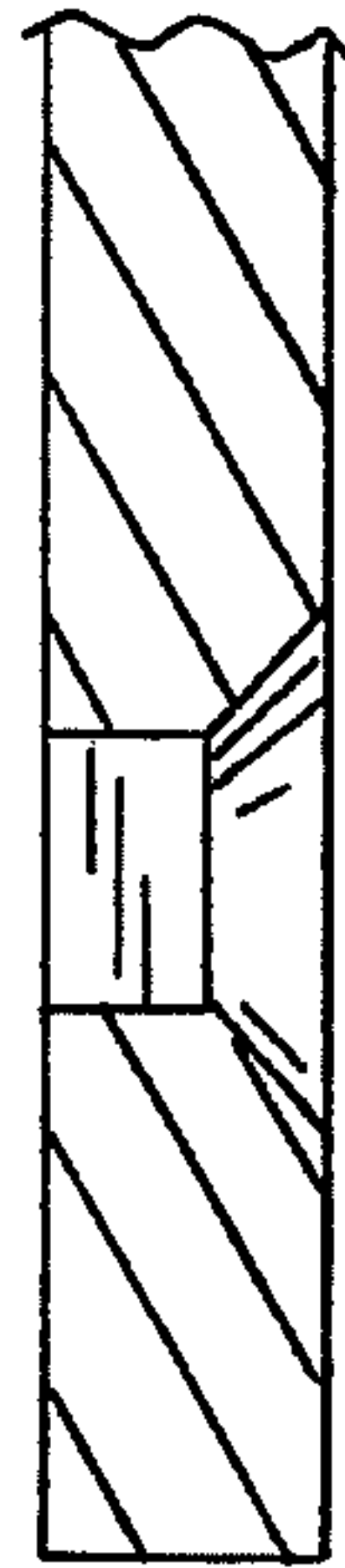

FIG. 5

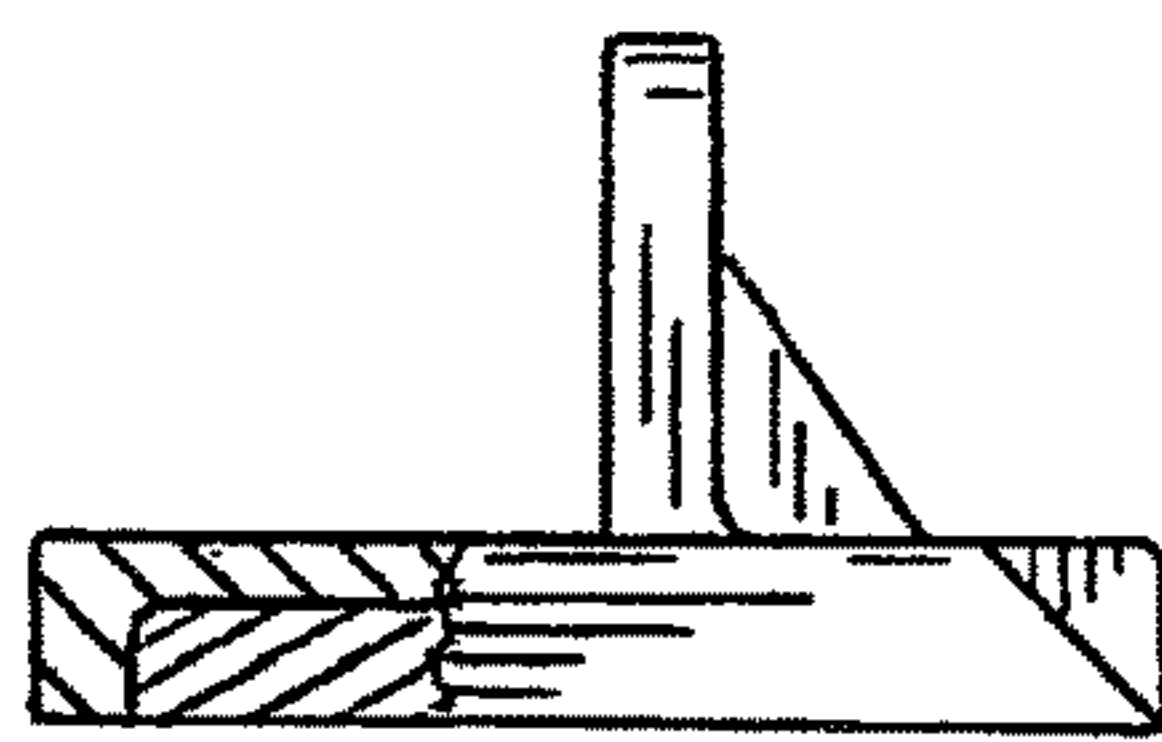

FIG. 7

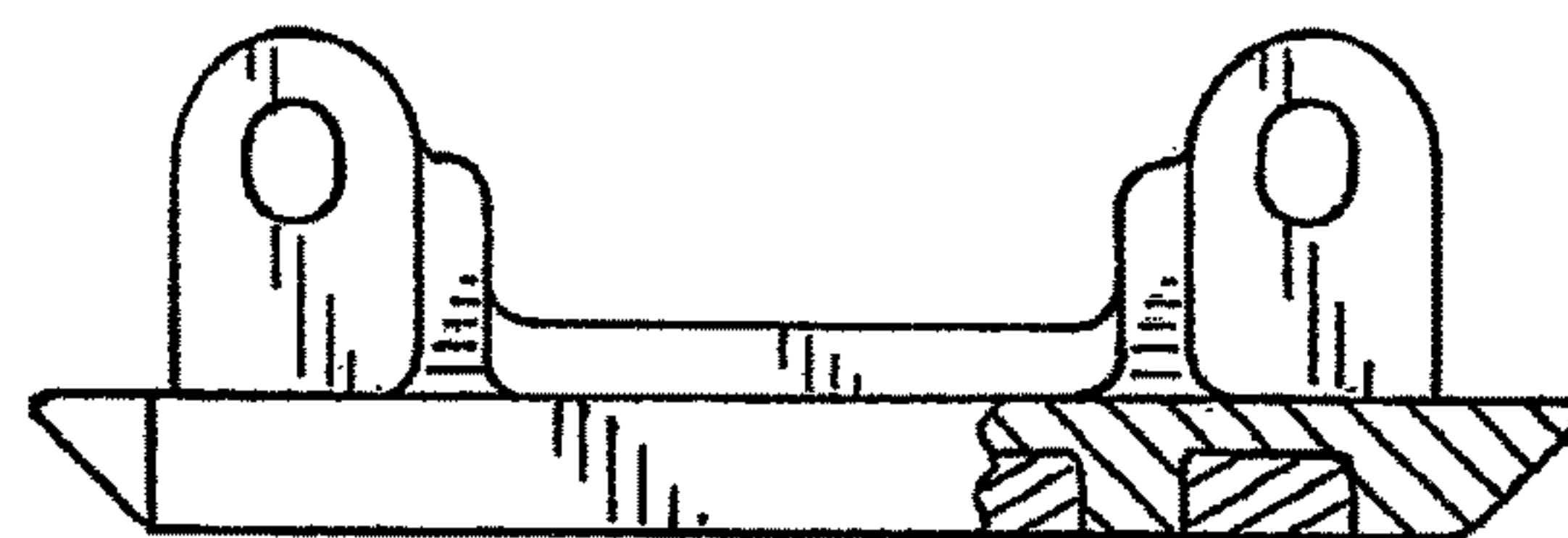

FIG. 6

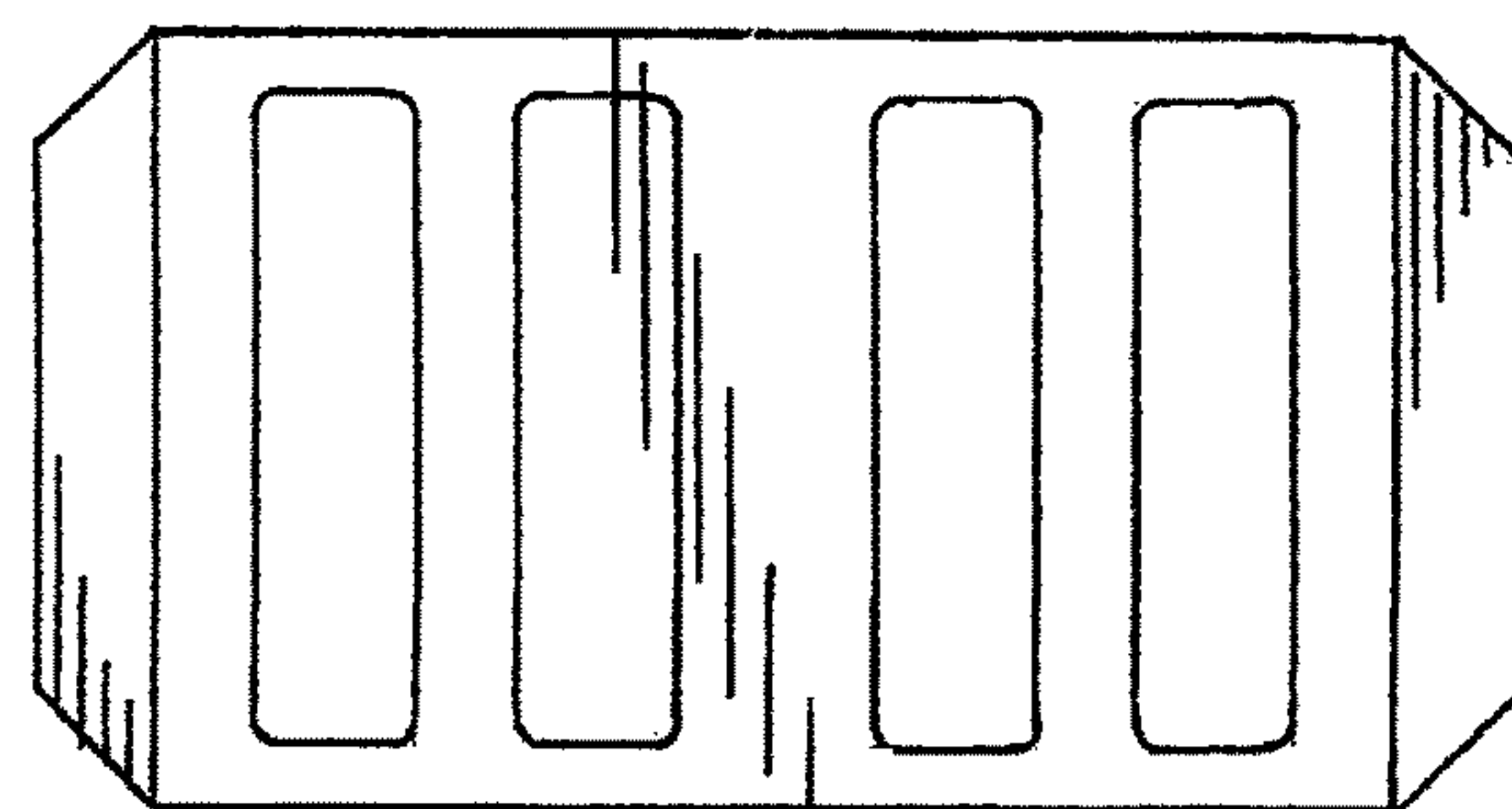

FIG. 8

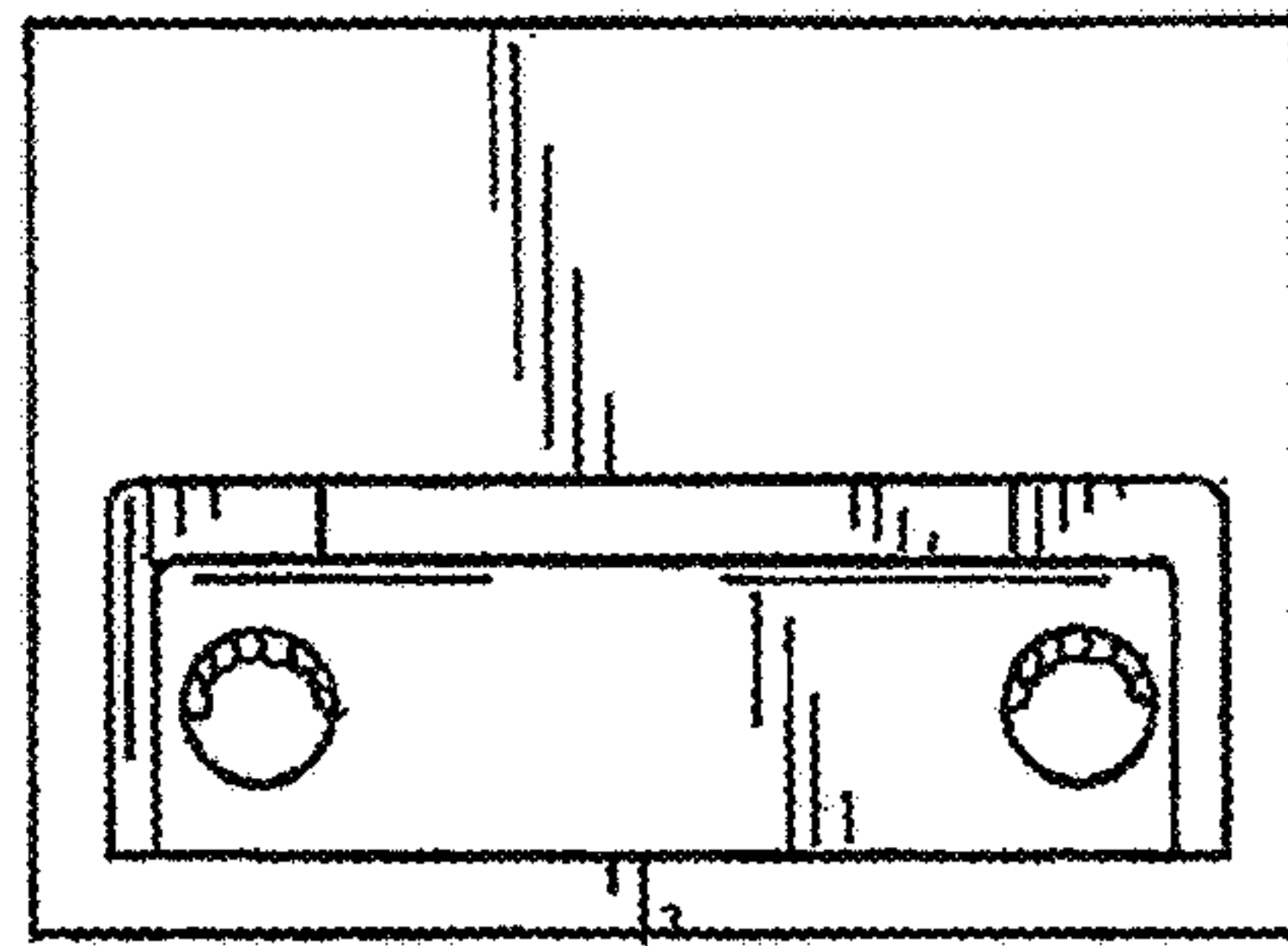

FIG. 10

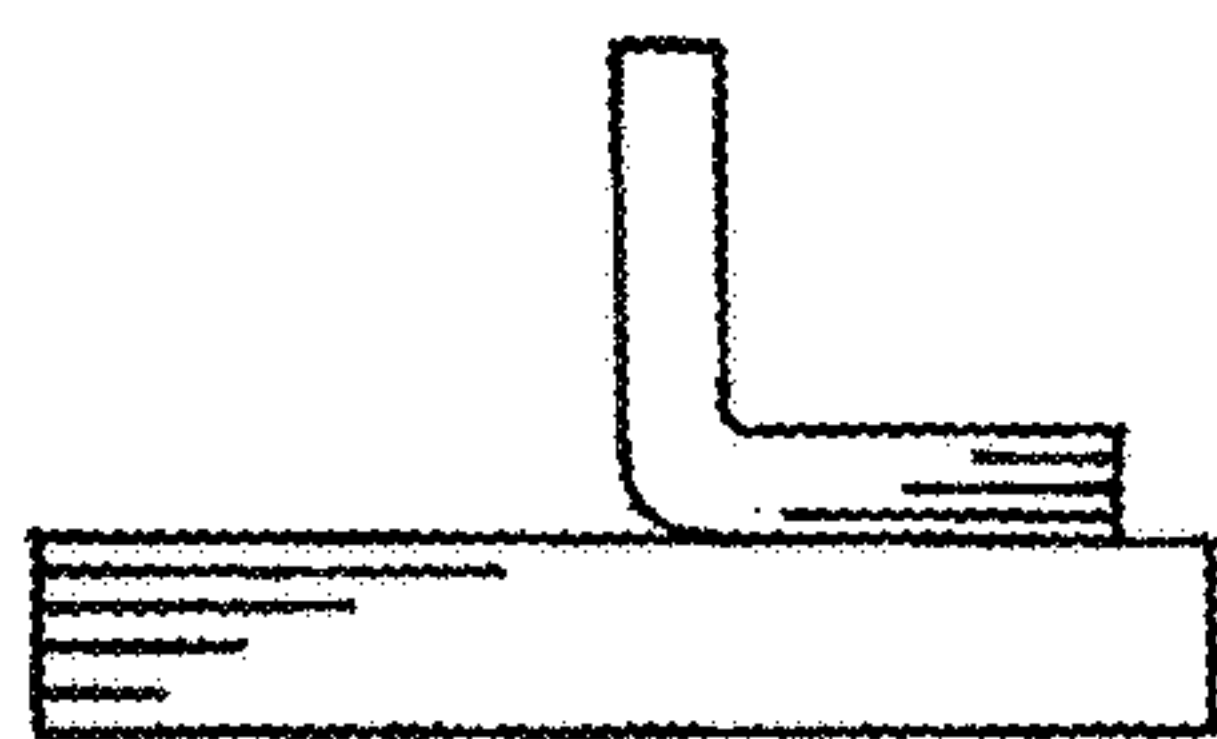

FIG. 11

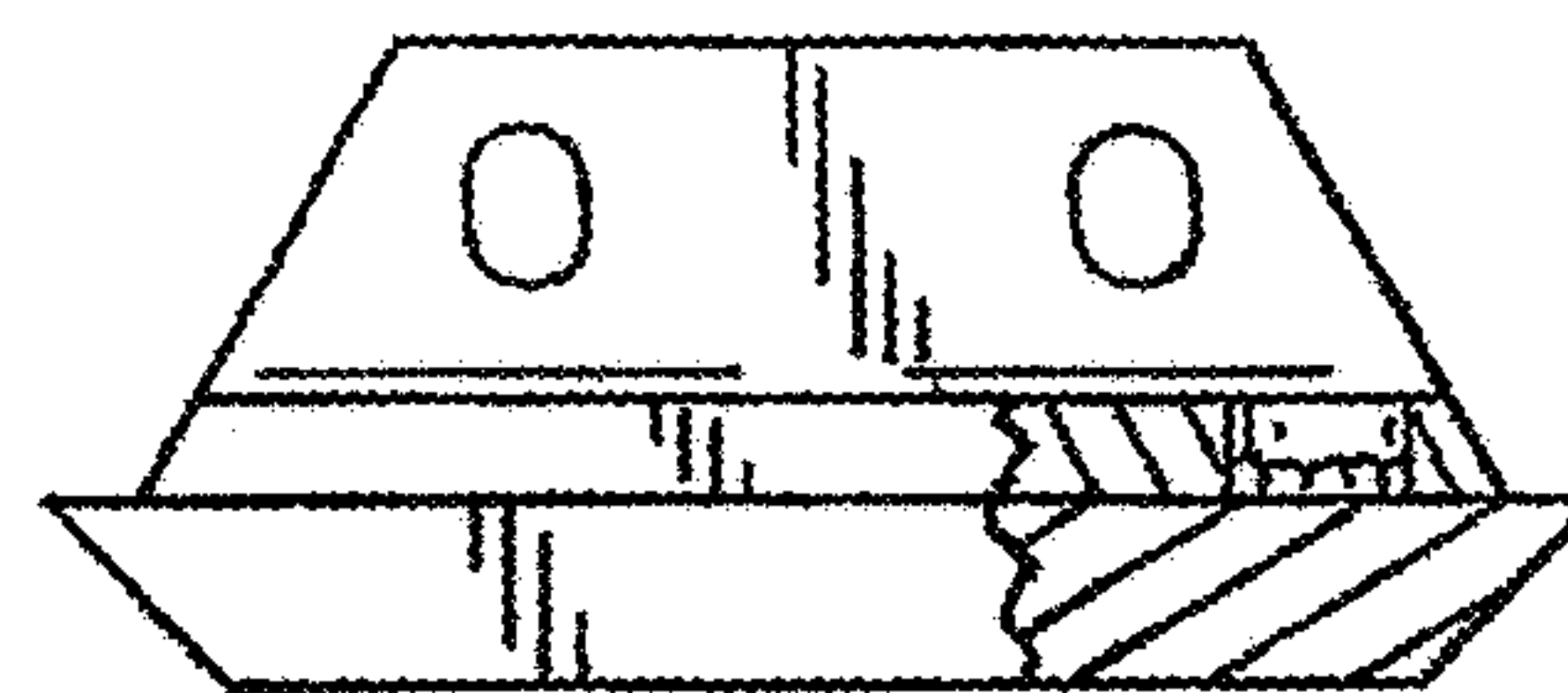

FIG. 9