



US00D816676S

(12) **United States Design Patent**
Badarello

(10) **Patent No.:** **US D816,676 S**

(45) **Date of Patent:** **** May 1, 2018**

- (54) **CANOPY FOR A CEILING FAN**
- (71) Applicant: **HUNTER FAN COMPANY**,
Memphis, TN (US)
- (72) Inventor: **Christophe Badarello**, Holly Springs,
MS (US)
- (73) Assignee: **Hunter Fan Company**, Memphis, TN
(US)
- (**) Term: **15 Years**
- (21) Appl. No.: **29/557,368**
- (22) Filed: **Mar. 8, 2016**
- (51) **LOC (11) Cl.** **14-02**
- (52) **U.S. Cl.**
USPC **D14/411; D26/138**
- (58) **Field of Classification Search**
USPC D23/377, 385, 413, 411, 249, 252, 254;
D26/51, 59, 67, 72, 85, 88-90, 113, 118,
D26/120, 124, 138; D8/350, 330-331,
D8/352-353; D6/524, 550; D7/300, 510,
D7/511, 900
CPC F04D 25/088; F21V 33/0096
See application file for complete search history.

- D409,742 S * 5/1999 Yang D23/377
- D428,982 S * 8/2000 Oldenburg D23/377
- D428,984 S 8/2000 Lee
- D434,844 S * 12/2000 Williams D23/377
- D446,851 S 8/2001 Lee
- D448,669 S * 10/2001 Carducci D9/454
- D451,593 S 12/2001 Lee
- D477,068 S 7/2003 Hsieh
- D484,587 S 12/2003 Bucher et al.
- D513,166 S * 12/2005 Huang D8/350
- D521,628 S * 5/2006 Hidalgo D23/377
- D524,928 S 7/2006 Young

(Continued)

OTHER PUBLICATIONS

Thurman Wall Sconce, posted date unknown, site visited Oct. 30, 2017, Copyright © 1997-2017, Available from Internet, <<https://www.rejuvenation.com/catalog/products/thurman-wall-sconce>>.*

(Continued)

Primary Examiner — Cathron C Brooks

Assistant Examiner — Sharon S Oum

(74) *Attorney, Agent, or Firm* — McGarry Bair PC

(57) **CLAIM**

The ornamental design for a canopy for a ceiling fan, as shown and described.

DESCRIPTION

FIG. 1 is a bottom perspective view of a canopy for a ceiling fan showing my new design; FIG. 2 is a top perspective view of the canopy of FIG. 1; FIG. 3 is a top view of the canopy of FIG. 1; FIG. 4 is a front side view of the canopy of FIG. 1, with rear, right, and left side views being mirror images thereof; and, FIG. 5 is a bottom view of the canopy of FIG. 1. The broken lines showing a ceiling fan illustrates the environment of the canopy for a ceiling fan and form no part of the claimed design.

1 Claim, 3 Drawing Sheets

- (56) **References Cited**
- U.S. PATENT DOCUMENTS
- D77,096 S * 12/1928 Jaffe et al. D26/88
- D312,868 S * 12/1990 Rezek D23/377
- D322,475 S * 12/1991 Markwardt D23/377
- D323,028 S 1/1992 Holbrook
- D329,894 S 9/1992 Scofield
- 5,151,011 A * 9/1992 Rezek F04D 25/088
416/5
- D376,008 S 11/1996 Chan
- D384,737 S * 10/1997 Gee, II D23/377
- D387,149 S * 12/1997 Tsuji D23/377
- D399,554 S * 10/1998 Tsuji D23/377

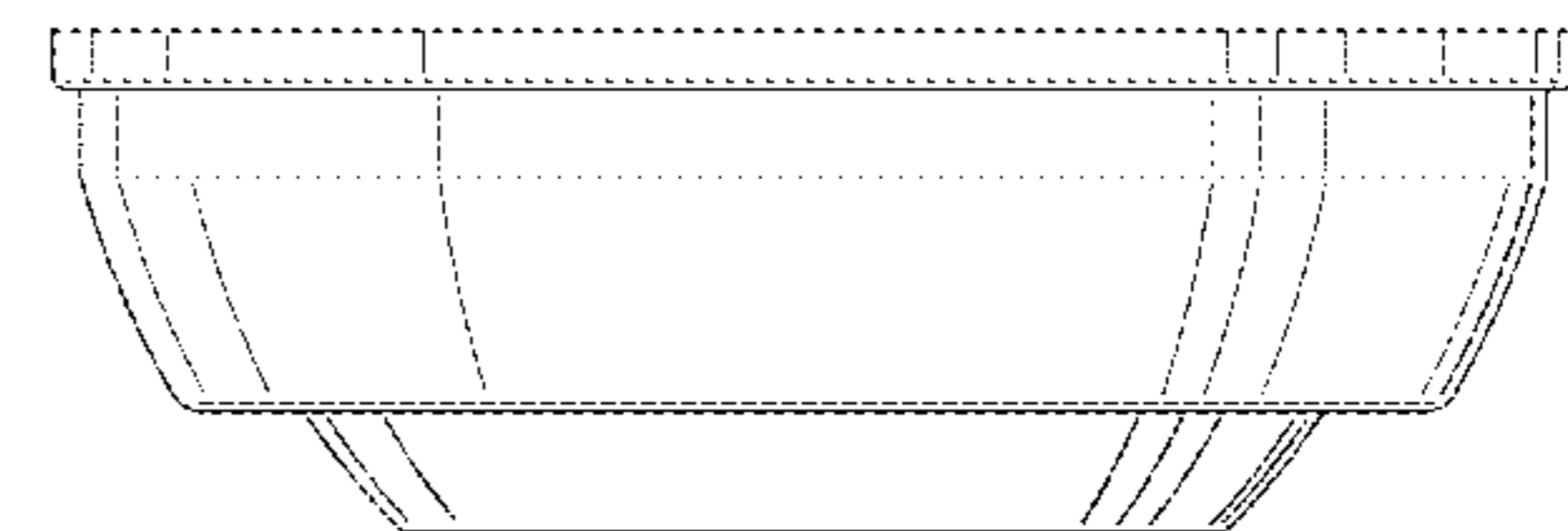
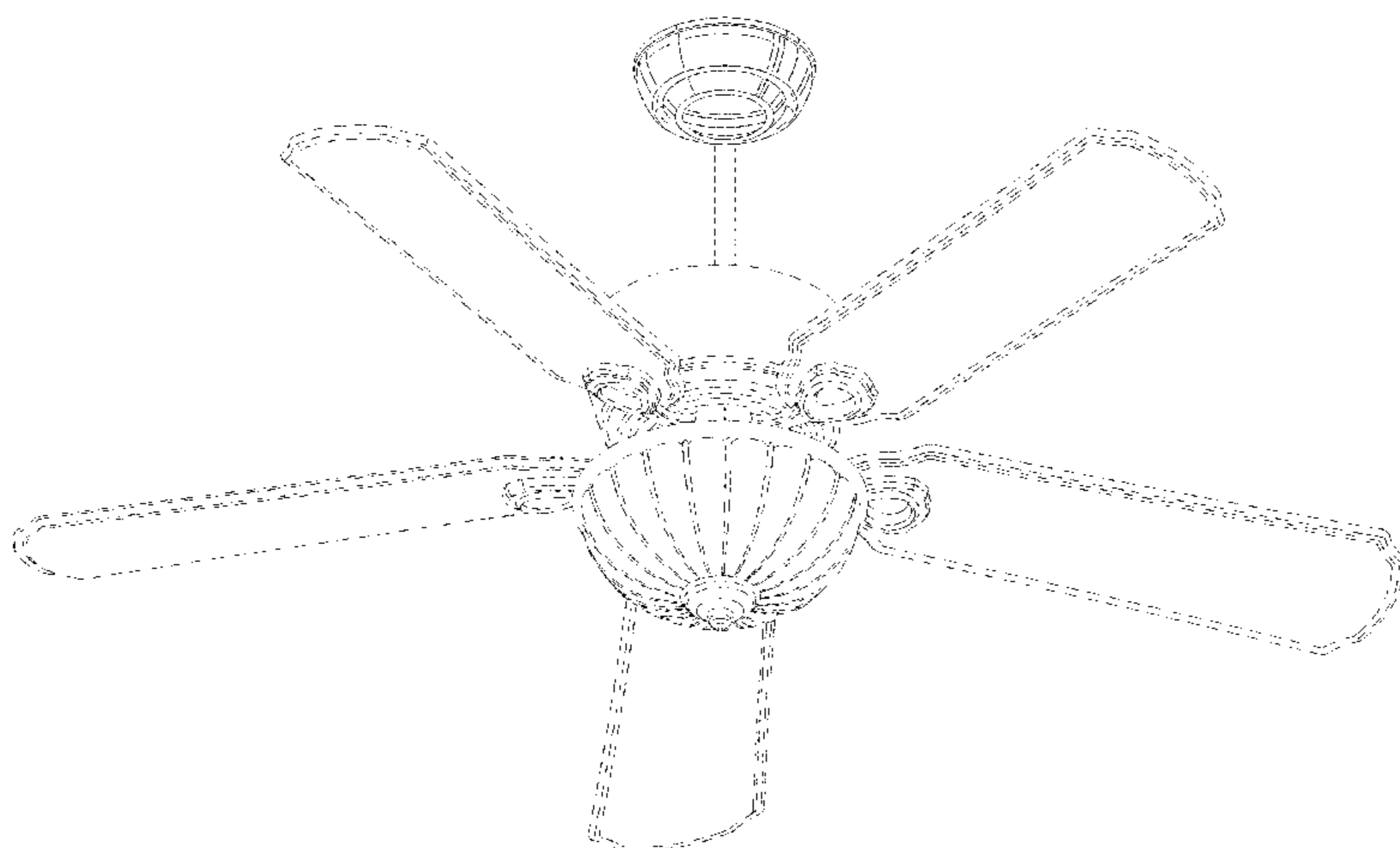

(56)

References Cited

U.S. PATENT DOCUMENTS

D531,338	S	*	10/2006	Chen	D26/59
D532,103	S	*	11/2006	Pickett	D23/411
D545,422	S		6/2007	Glasbrenner		
D548,320	S		8/2007	Frampton		
D555,779	S	*	11/2007	Bucher	D23/377
D557,791	S	*	12/2007	Cox	D23/411
D567,361	S	*	4/2008	Curtin	D23/411
D572,813	S	*	7/2008	Hidalgo	D23/377
D573,243	S		7/2008	Pan		
D575,902	S	*	8/2008	Ricereto	D26/138
D582,028	S	*	12/2008	Lai	D23/377
D585,974	S	*	2/2009	Curtin	D23/411
D600,339	S		9/2009	Searle		
D603,035	S		10/2009	Yang		
D620,581	S		7/2010	Chen		
D621,497	S		8/2010	Chen		
D632,381	S	*	2/2011	Davenport	D23/377
D659,802	S	*	5/2012	McKeone	D23/252
D661,792	S	*	6/2012	VanOttentolman	D23/377
D663,829	S	*	7/2012	Allen	D23/377
D678,752	S	*	3/2013	Sedwick	D23/249
D679,171	S	*	4/2013	Sedwick	D23/249
D679,797	S		4/2013	Chen		
D707,807	S	*	6/2014	Pan	D23/377
D713,722	S	*	9/2014	Miller	D9/436
D718,136	S	*	11/2014	Harrity	D9/499
D719,252	S		12/2014	Allen et al.		
D741,988	S		10/2015	Pan		
D760,368	S	*	6/2016	Chen	D23/377
D762,296	S	*	7/2016	Badarello	D23/377
D781,818	S	*	3/2017	Pera	D14/172
9,664,197	B2	*	5/2017	Walker	F04D 25/0693

OTHER PUBLICATIONS

3-Light Bowl Ceiling Fan Light Kit, date first reviewed Aug. 25, 2014, site visited Nov. 2, 2017, Copyright © 2002-2017, Available from Internet, <<https://www.wayfair.com/lighting/pdp/royal-pacific-3-light-bowl-ceiling-fan-light-kit-ryp1221.html>>.*
 Courtyard Ceiling Fan, posted date unknown, site visited Nov. 2, 2017, Copyright © 2017, <http://www.neimanmarcus.com/Courtyard-Ceiling-Fan/prod200030086/p.prod?utm_medium=affiliate&parentId=cat59040731&ecid=NMAF_ShopStyle%20UK&CS_003=5630585&utm_source=NMAF_ShopStyle%20UK>.*
 Schlage Champagne Privacy Lever, date first available May 10, 2007, site visited Nov. 2, 2017, Copyright © 1996-2017, <https://www.amazon.com/Schlage-Champagne-Privacy-Andover-Nickel/dp/B000PHBEO4/ref=sr_1_2?ie=UTF8&qid=1509657020&sr=8-2&keywords=schlage+champagne+satin+nickel+bed+and+bath+lever>.*
 LASCO 03-6021 Tub Spout/Shower Arm Flange, date first available Mar. 2, 2015, site visited Nov. 10, 2017, Copyright © 1996-

2017, <https://www.amazon.com/LASCO-03-6021-Shower-Flange-Chrome/dp/B00UA7IMDK/ref=sr_1_30?s=hi&ie=UTF8&qid=1510368252&sr=1-30&keywords=Delta+Chrome+Shower+Arm+Flange>.*
 How long can this shower curtain rod be extended to?, posted date Jan. 7, 2016, site visited Nov. 16, 2017, Copyright © 2017, Available from Internet, <<https://www.houzz.com/discussions/3598434/how-long-can-this-shower-curtain-rod-be-extended-to>>.*
<http://www.kingoffans.com/#/products/ceilingFans>, Cameron II, accessed Mar. 8, 2016.
<http://ceilingfans.emerson.com/shop/en/fan/fans-s-emerson-fans/fans-s-traditional/designer-fan-p-cf755>, Designer, CF755ORB, accessed Mar. 8, 2016.
http://www.cens.com/cens/html/en/product/product_main_77129.html, Aquarius-champagne light series, AC413, accessed Mar. 8, 2016.
<http://www.minkagroup.net/products/f556-bndw>, Contractor Plus, F556-BN/DW, accessed Mar. 8, 2016.
<http://www.kingoffans.com/#/products/ceilingFans>, Accubreeze, accessed Mar. 8, 2016.
<http://www.craftmade.com/Craftmade-CXL52AGBronze-Ceiling-Fan.HTM>, Craftmade—CXL52AG—CXL 52" Ceiling Fan in Aged Bronze Textured, CXL52AG, accessed Mar. 8, 2016.
<http://www.fanimation.com/products/index.php/fans/camhaven.html>, Camhaven, FP8095, accessed Mar. 8, 2016.
http://www.lowes.com/pd_451795-82939-40114_1z0vgaxZ1z140v4_?productId=50057207&pl=1, Harbor Breeze Classic 42-in White Downrod or Flush Mount Indoor/Outdoor Ceiling Fan, 451795, accessed Mar. 8, 2016.
<http://www.hunterpacific.com.au/typhoonM2.php>, Typhoon Mach 2, accessed Mar. 8, 2016.
<http://www.hunterpacific.com.au/revolution.php>, Revolution 2, accessed Mar. 8, 2016.
<http://www.craftmade.com/Craftmade-FA52BN5Nickel-Ceiling-Fan.HTM>, Craftmade—FA52BN5—5th Avenue 52" Ceiling Fan Blades Included in Brushed Nickel with Matte Opal Glass, FA52BN5, accessed Mar. 8, 2016.
<http://www.kingoffans.com/#/products/ceilingFans>, Palm Beach, accessed Mar. 8, 2016.
<http://www.craftmade.com/Craftmade-VE58SS3-Stainless-Steel-Ceiling-Fan.HTM>, Velocity, VE58SS3, Mar. 8, 2016.
<http://www.menards.com/main/lighting-ceiling-fans/ceiling-fans/shop-all-ceiling-fans/turn-of-the-century-reg-ashton-52-brushed-nickel-ceiling-fan/p-1444424531588-c-7488.htm?tid=7022888069991374527>, Turn of the Century® Ashton 52" Brushed Nickel Ceiling Fan, 35060, Mar. 8, 2016.
http://www.lowes.com/pd_593755-88854-LP8321LAZ_1z0vgaxZ1z140v4_?productId=50244893&pl=1, Harbor Breeze Platinum Aniva Bay 52-in Aged Bronze Downrod Mount Indoor/Outdoor Ceiling Fan with Remote (3-Blade) Energy Star, 593755, Mar. 8, 2016.

* cited by examiner

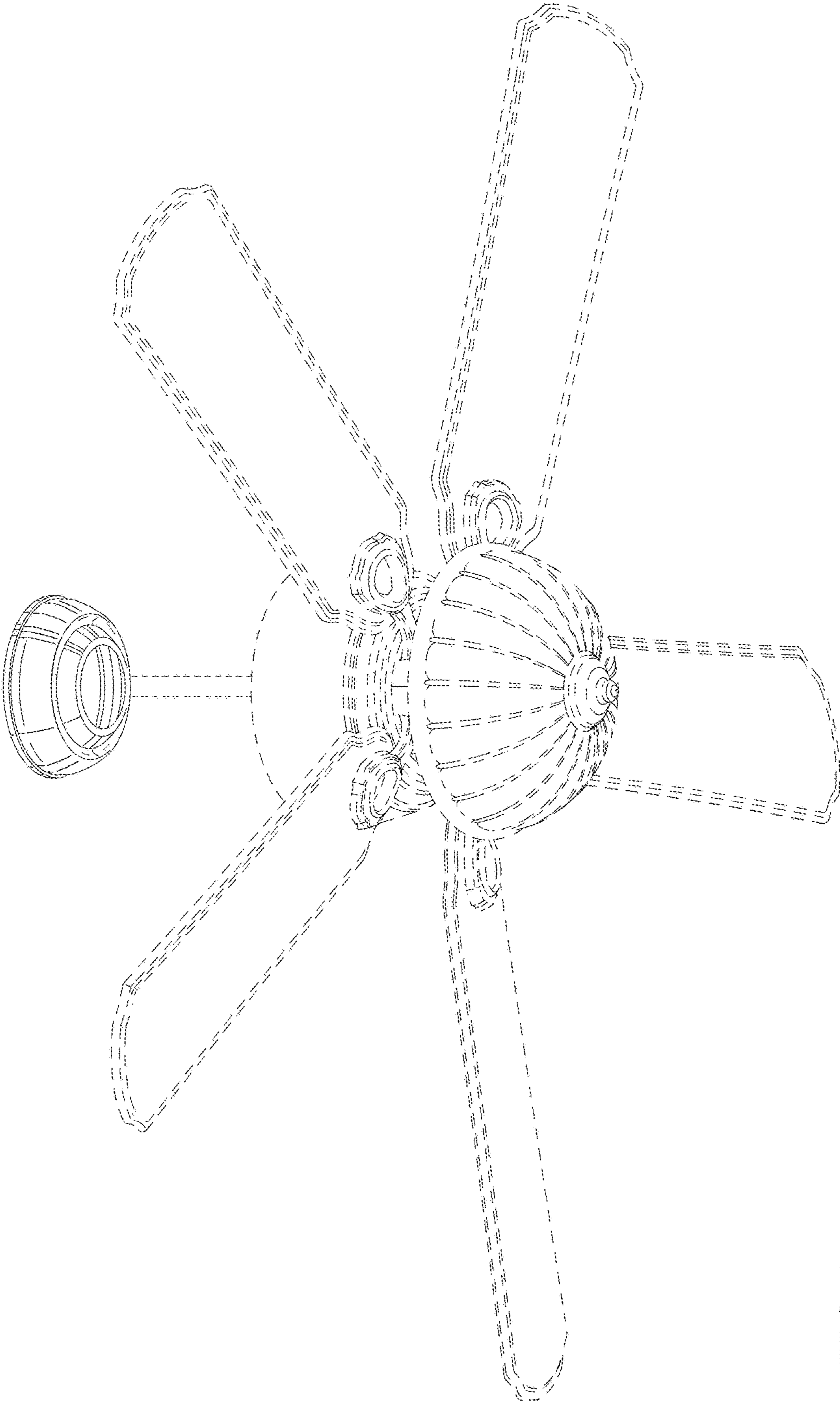

FIG. 1

FIG.2

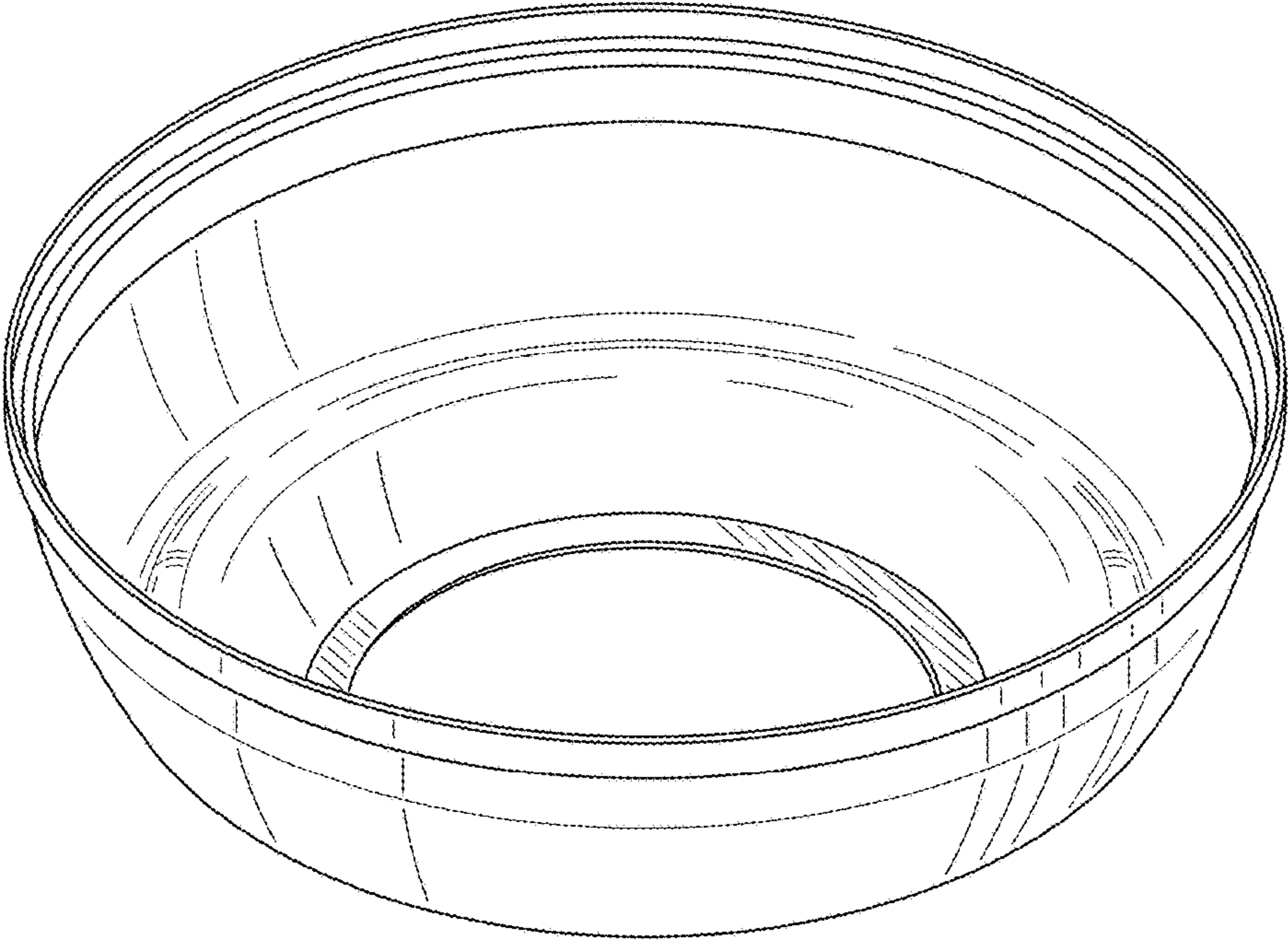
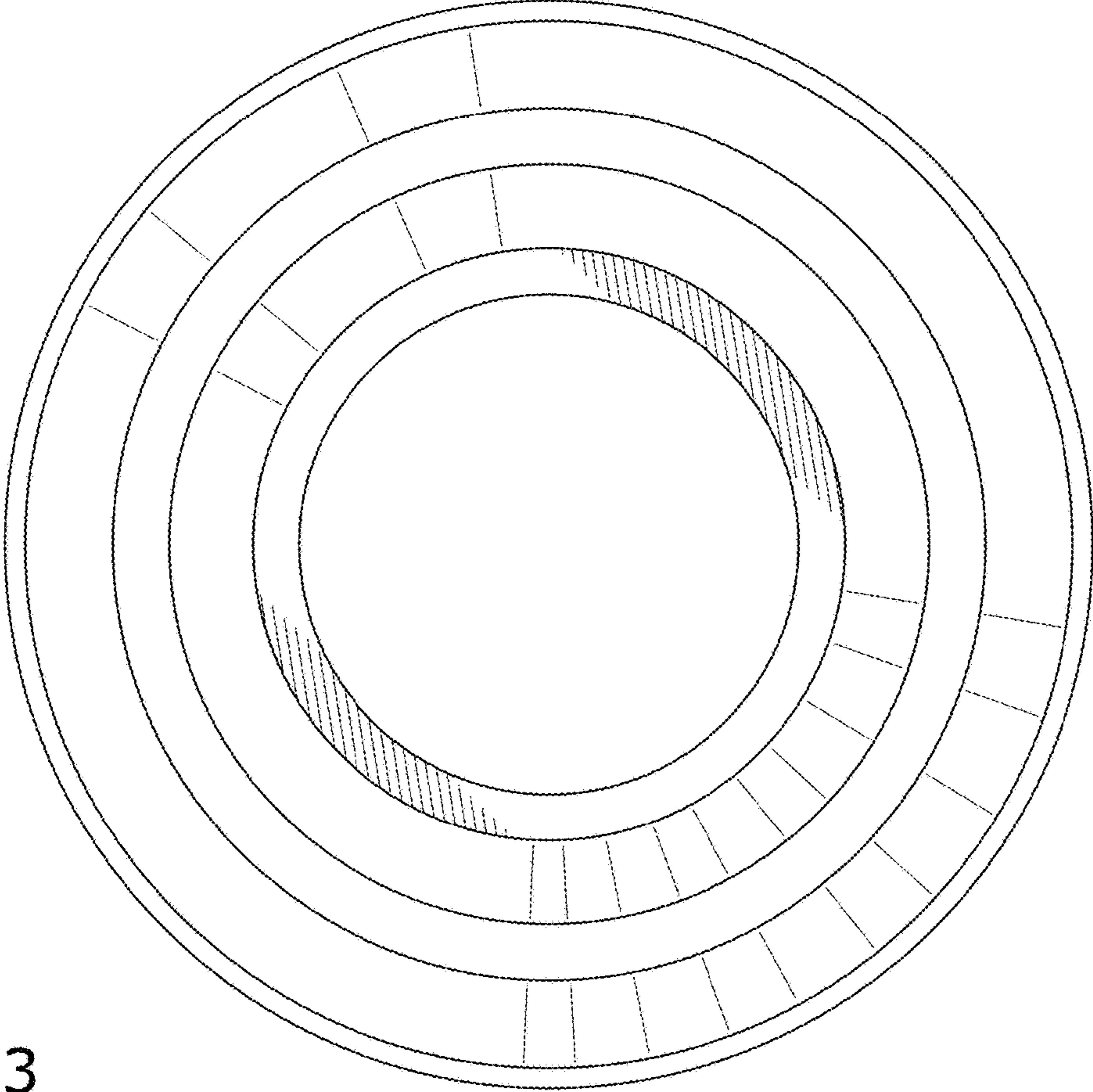

FIG.3



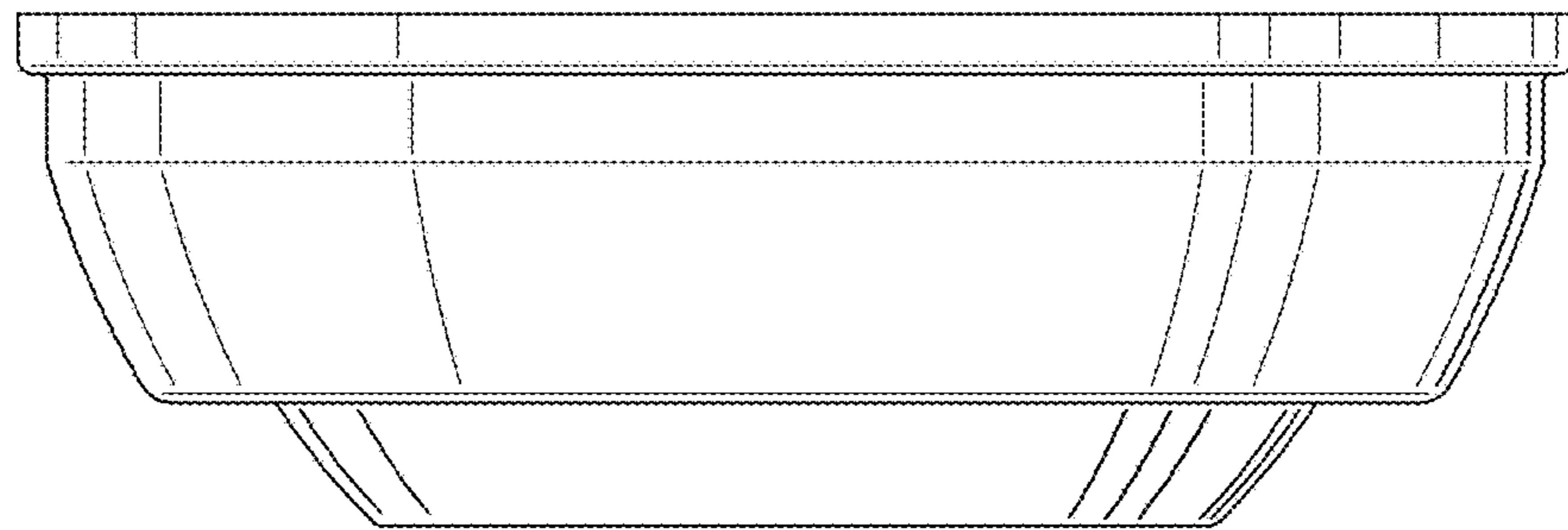

FIG. 4

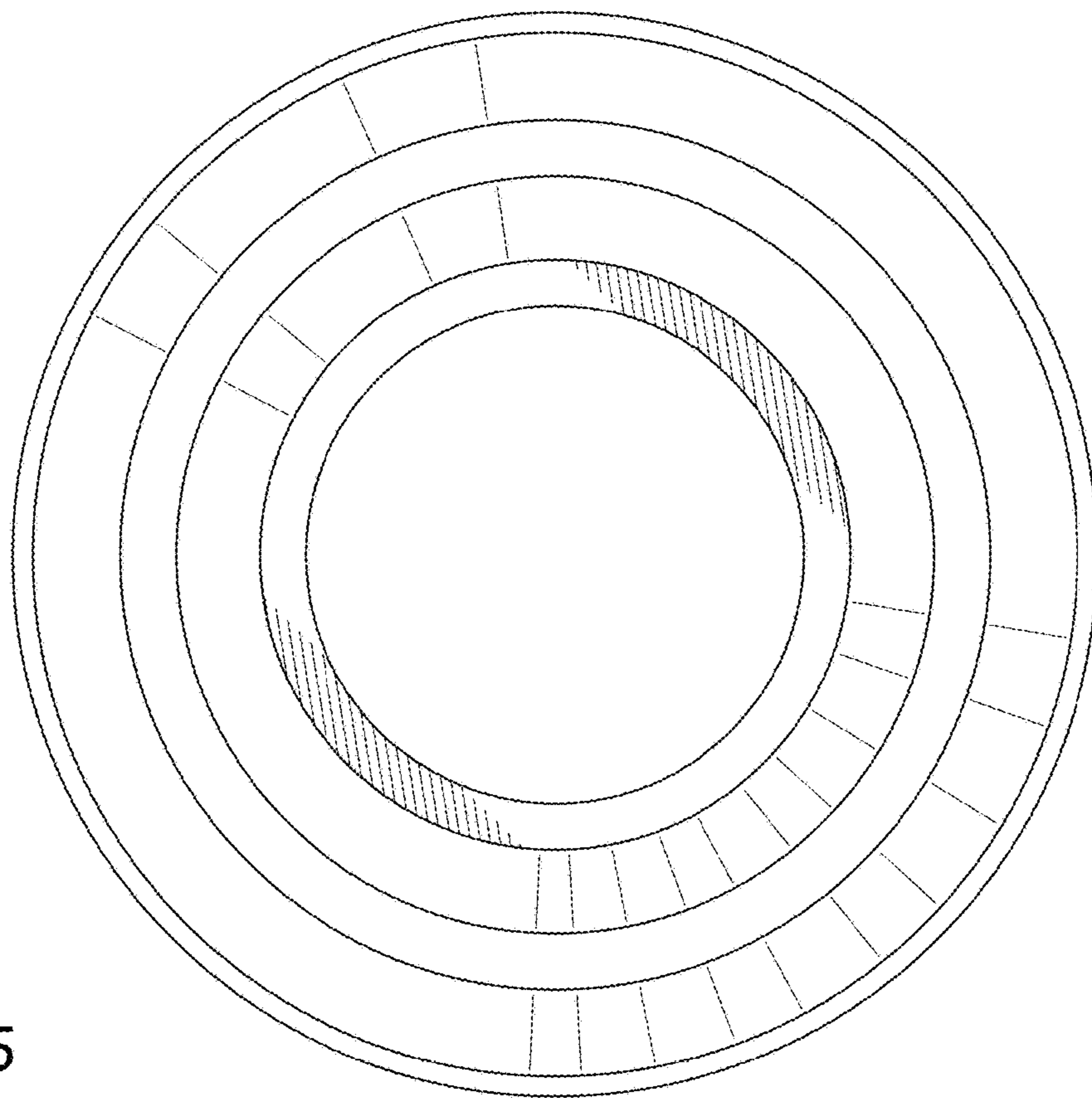

FIG. 5