



US00D816657S

(12) **United States Design Patent** (10) **Patent No.:** **US D816,657 S**  
**Kim et al.** (45) **Date of Patent:** **\*\* May 1, 2018**

(54) **STAND FOR WRIST-WORN ELECTRONIC DEVICE**  
(71) Applicant: **Spigen Korea Co, LTD.**, Seoul (KR)  
(72) Inventors: **Dae-Young Kim**, Seoul (KR); **Bum Joon Lee**, Seoul (KR)  
(73) Assignee: **SPIGEN KOREA CO., LTD.**, Bongeunsa-ro, Gangnam-gu, Seoul (KR)  
(\*\*) Term: **15 Years**  
(21) Appl. No.: **29/569,540**  
(22) Filed: **Jun. 28, 2016**

Jun. 6, 2017]. Available from Internet, <URL: <https://wholesaler.alibaba.com/w/wholesale-silver-gold-pocket-watch.html/>>.\*

(Continued)

*Primary Examiner* — Philip S Hyder  
*Assistant Examiner* — Cary M Robinson  
(74) *Attorney, Agent, or Firm* — Heedong Chae; Lucem, PC

(57) **CLAIM**

The ornamental design for a stand for wrist-worn electronic device, as shown and described.

**DESCRIPTION**

FIG. 1 is a front perspective view of a stand, having a supporting member and an electronic device holder, for wrist-worn electronic device showing my new design; FIG. 2 is a rear perspective view thereof; FIG. 3 is a front elevational view thereof; FIG. 4 is a rear elevational view thereof; FIG. 5 is a left side elevational view thereof; and FIG. 6 is a right side elevational view thereof; FIG. 7 is a top plan view thereof; FIG. 8 is a bottom plan view thereof; FIG. 9 is a front perspective view of the supporting member; FIG. 10 is a rear perspective view of the supporting member; FIG. 11 is a front perspective view of the electronic device holder; FIG. 12 is a rear perspective view of the electronic device holder; FIG. 13 is a front perspective view of the stand for wrist-worn electronic device in which the supporting member and the electronic device holder are shown separated for clarity of disclosure; and, FIG. 14 is a rear perspective view of the stand for wrist-worn electronic device in which the supporting member and the electronic device holder are shown separated for clarity of disclosure.

The broken lines illustrate portions of the stand for wrist-worn electronic device and form no part of the claimed

(Continued)

**Related U.S. Application Data**

(63) Continuation of application No. 29/523,594, filed on Apr. 10, 2015, now Pat. No. Des. 788,762, and a (Continued)  
(51) **LOC (11) Cl.** ..... **14-03**  
(52) **U.S. Cl.**  
USPC ..... **D14/253**; D14/250; D14/251  
(58) **Field of Classification Search**  
USPC ..... D3/218; D6/406.3, 406.4, 406.5, 406.6, D6/680.2, 684, 551–552, 554, 556, 607, (Continued)

(56) **References Cited**

**U.S. PATENT DOCUMENTS**

D234,851 S 4/1975 Tyson  
3,964,709 A 6/1976 LaBelle  
(Continued)

**OTHER PUBLICATIONS**

Alibaba | Wholesale| Timepieces, Jewelry, Eyewear | Watches | Pocket Watches | wholesale silver gold pocket watch, last updated on Apr. 29, 2016, © 1999-2016 Alibaba.com [online], [site visited

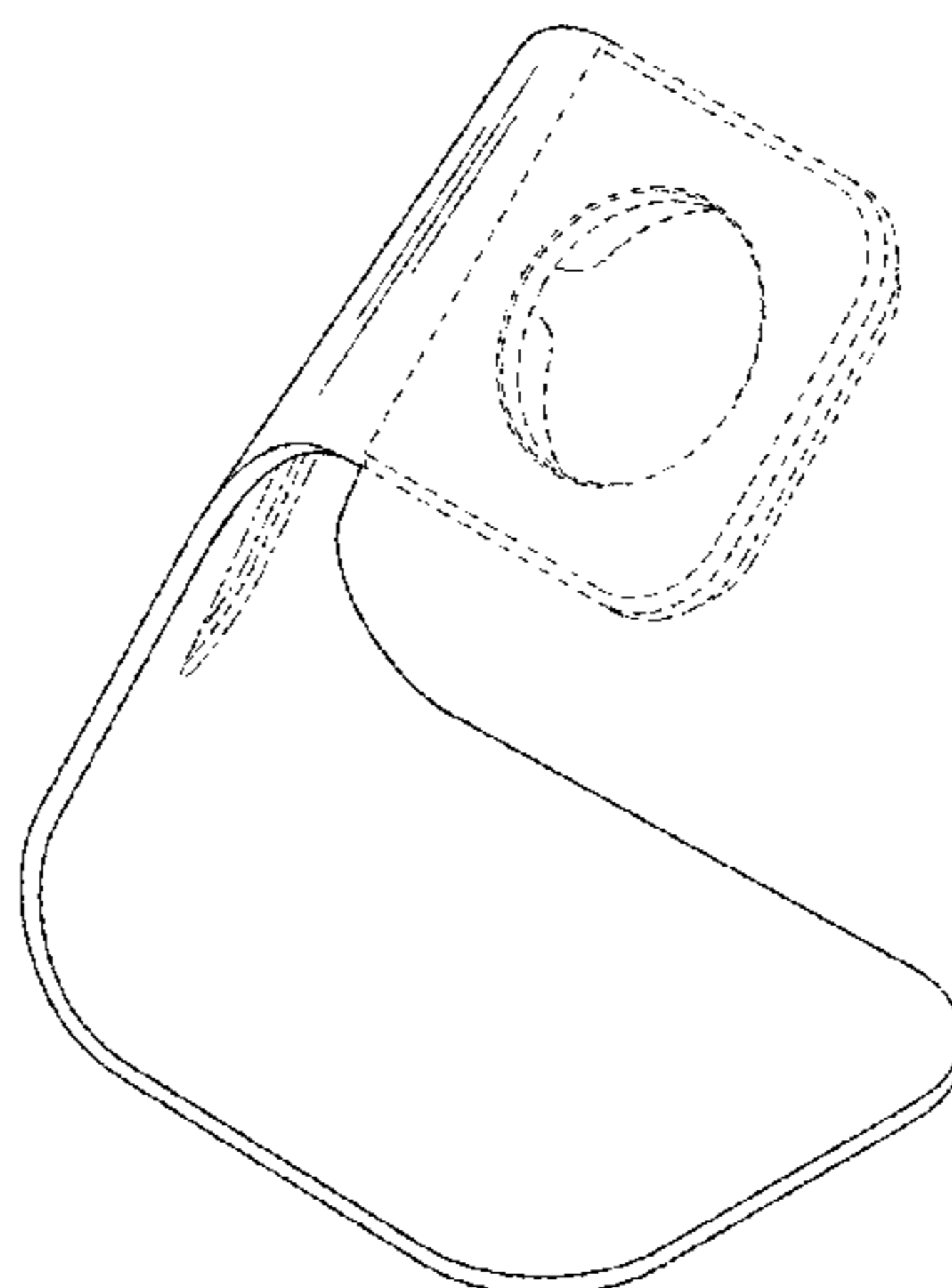

design. The dash-dot lines define boundaries of the claim that form no part of the claim.

**1 Claim, 14 Drawing Sheets**

**Related U.S. Application Data**

continuation of application No. 29/523,592, filed on Apr. 10, 2015, now Pat. No. Des. 788,094.

(58) **Field of Classification Search**

USPC ..... D6/623; D8/70-73; D14/250-251, 253, D14/432, 434, 439-440, 447, 451-452, D14/457; D28/18; D30/162  
 CPC ..... A45C 2011/003; A45C 2011/002; A45C 13/002; A47B 2021/0307; A47B 2023/005; A47B 2023/049; A47B 2097/005; A47B 2097/006; A47B 21/04; A47B 23/00; A47B 23/043; F16M 2200/00; H04B 1/3888; H04M 1/04; H04M 1/185

See application file for complete search history.

(56) **References Cited**

U.S. PATENT DOCUMENTS

D252,088 S *	6/1979	Johansson	D14/253
D280,263 S	8/1985	Hoye	
D308,730 S	6/1990	Nakagawa	
D310,520 S	9/1990	Bedard	
D330,902 S *	11/1992	Siden	D15/126
D494,216 S *	8/2004	Yan	D18/56
D513,168 S *	12/2005	Chu	D8/356
D536,124 S	1/2007	Liao	
D556,363 S	11/2007	Komar	
D580,578 S	11/2008	Chien	
D625,539 S *	10/2010	Kolada	D6/552
D636,928 S	4/2011	Lin	
D642,736 S	8/2011	Reidy	
D645,865 S	9/2011	Diehl	
D673,321 S	12/2012	Karkkainen	
D681,438 S *	5/2013	Chen	D8/394
D681,439 S *	5/2013	Chen	D8/394
D692,010 S	10/2013	Vergheze	
D692,899 S	11/2013	Bremenkamp	
D703,520 S *	4/2014	Schopf	D8/394
D717,289 S	11/2014	Takabatake	
D737,830 S	9/2015	Katopis	
9,151,439 B2 *	10/2015	Liang	F16M 11/046
D743,955 S	11/2015	Wu	
9,207,714 B2 *	12/2015	Boomhour	G06F 1/1632

D751,564 S	3/2016	Hahn	
D753,642 S	4/2016	Iimuro	
D762,650 S	8/2016	Dang	
D769,881 S *	10/2016	Lazzi	D14/452
D770,437 S	11/2016	Schwarz	
D770,438 S	11/2016	Schwarz	
D772,216 S	11/2016	Lau	
9,510,680 B2	12/2016	King	
D776,667 S *	1/2017	Fujioka	D14/447
9,565,909 B2	12/2017	Song	
2008/0234856 A1	9/2008	Saez	

OTHER PUBLICATIONS

Amazon | Art to Real Pack of 10 Patio Wicker Furniture Sectional Sofa Alignment Fasteners Clips Clamps Connectors—Middle and Large Size Options (M), first reviewed on Nov. 22, 2016, © 1996-2017, Amazon.com, Inc. [online], [site visited Jun. 6, 2017]. Available from Internet, <URL: <https://goo.gl/7oDFu4>>.\*  
 Amazon | Elkay LK363 Metal 14 Extra Long Screws and Clips, first reviewed on Mar. 18, 2010, © 1996-2017, Amazon.com, Inc. [online], [site visited Jun. 6, 2017]. Available from Internet, <URL: [https://www.amazon.com/dp/B000HBCE2E/ref=psdc\\_6810586011\\_t2\\_B00YO4TNME/](https://www.amazon.com/dp/B000HBCE2E/ref=psdc_6810586011_t2_B00YO4TNME/)>.\*  
 Dhgate | for Apple Smart Watch Wooden Stand Holder Mount Charger Docking Station for Apple iWatch Sport 38MM 42MM Accessories, first reviewed on Sep. 9, 2012, © 1996-2017, Amazon.com, Inc. [online], [site visited Jun. 6, 2017]. Available from Internet, <URL: <http://www.dhgate.com/product/100pcs-lots-for-galaxy-note-10-1-n8000-anti/143177198.html>>.\*  
 Alibaba | Products | Consumer Electronics | Mobile Phone & Accessories | Mobile Phone Holders (370228), posted on Jun. 15, 2016, © 1999-2016 Alibaba [online], [site visited Sep. 14, 2016]. Available from Internet, <URL: [https://www.alibaba.com/product-detail/new-arrival-nano-micro-suction-mobile\\_60253706490.html](https://www.alibaba.com/product-detail/new-arrival-nano-micro-suction-mobile_60253706490.html)>.\*  
 China Prices, posted on Nov. 23, 2015, [no copyright date posted] [online], [site visited Sep. 14, 2016]. Available from Internet, <URL: <http://chinaprices.net/?search=samsung+smart+watch>>.\*  
 eBay | Wooden Charging Dock Stand Holder Desktop for Smartwatch/Smartphone/Table Light, last updated on Mar. 22, 2016, © 1995-2016 eBay, Inc. [online], [site visited Sep. 14, 2016]. Available from Internet, <URL: <http://www.ebay.co.uk/itm/Wooden-Charging-Dock-Stand-Holder-Desktop-for-Smartwatch-Smartphone-Tablet-Light-/291612064661>>.\*  
 Szbro | Product | Cell Phone Accessories | Szbro Smart Watch Charging Stand Dock Platform Holder Compatible for Apple Watch [38mm][42mm] Both Models (Green), posted on Apr. 24, 2015, © 2016 www.szbro.com [online], [site visited Sep. 14, 2016]. Available from Internet, <URL: <http://www.szbro.com/product/B00YMDKVP0.html>>.\*

\* cited by examiner

FIG. 1

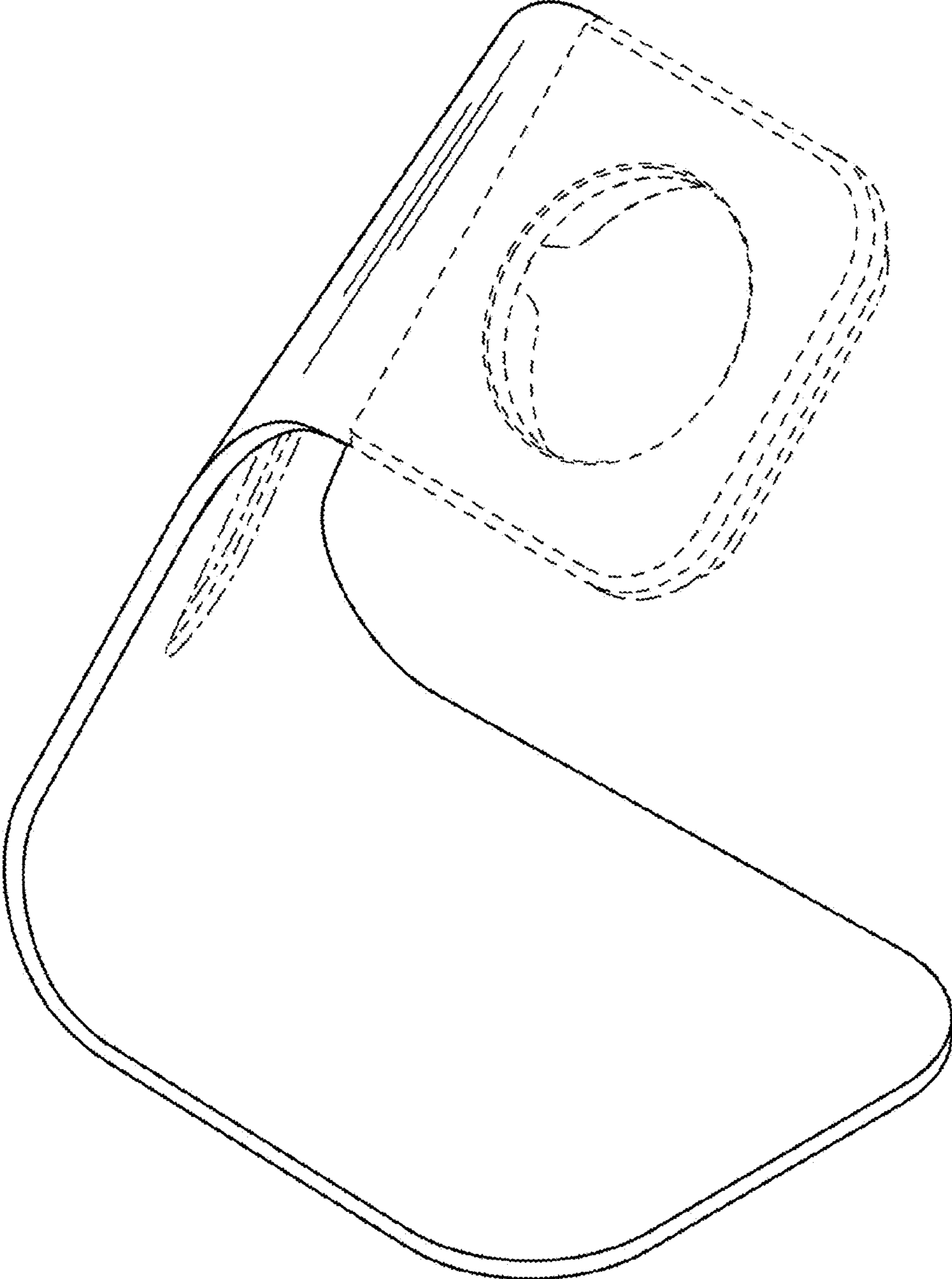

FIG. 2

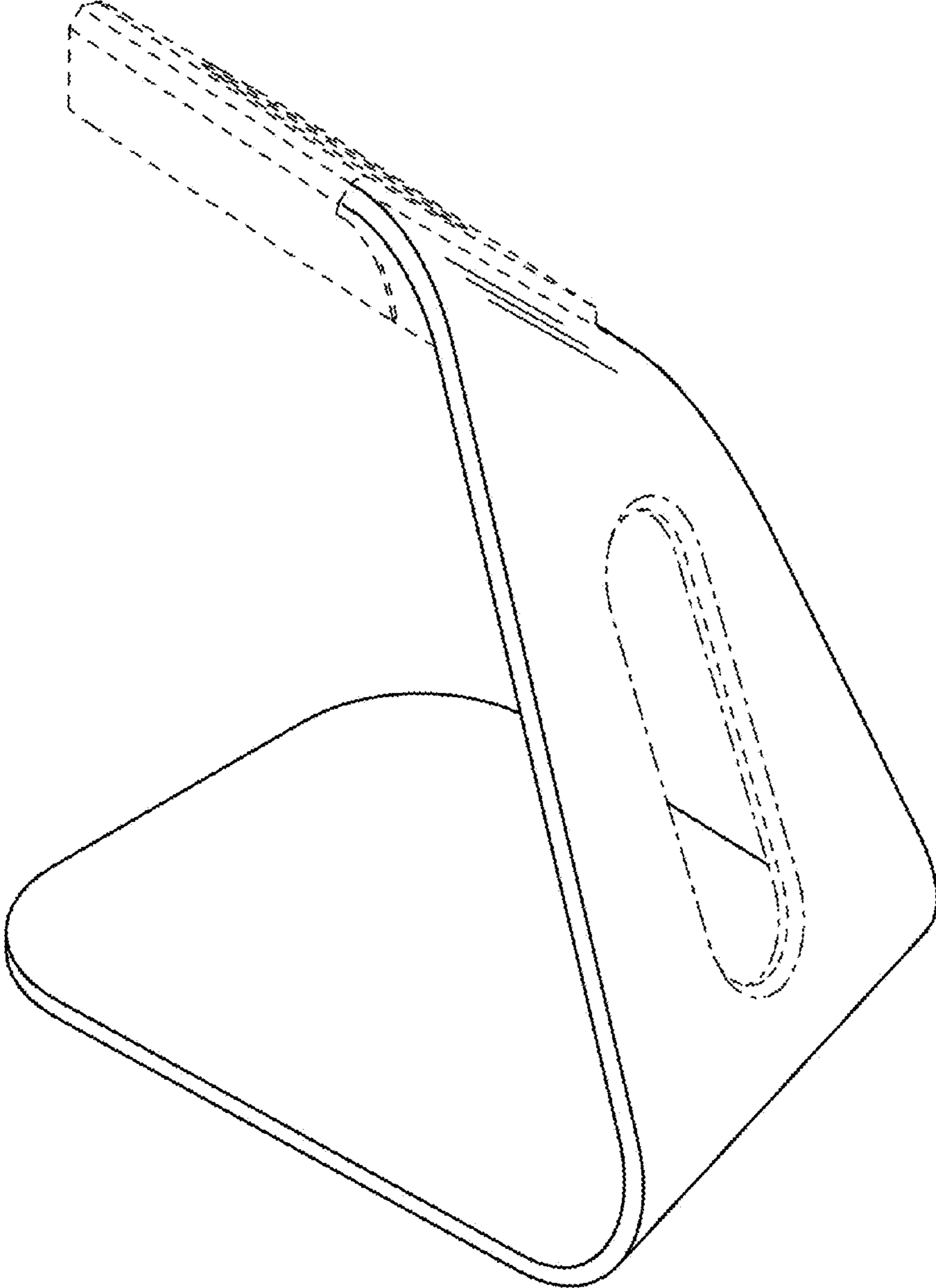

FIG. 3

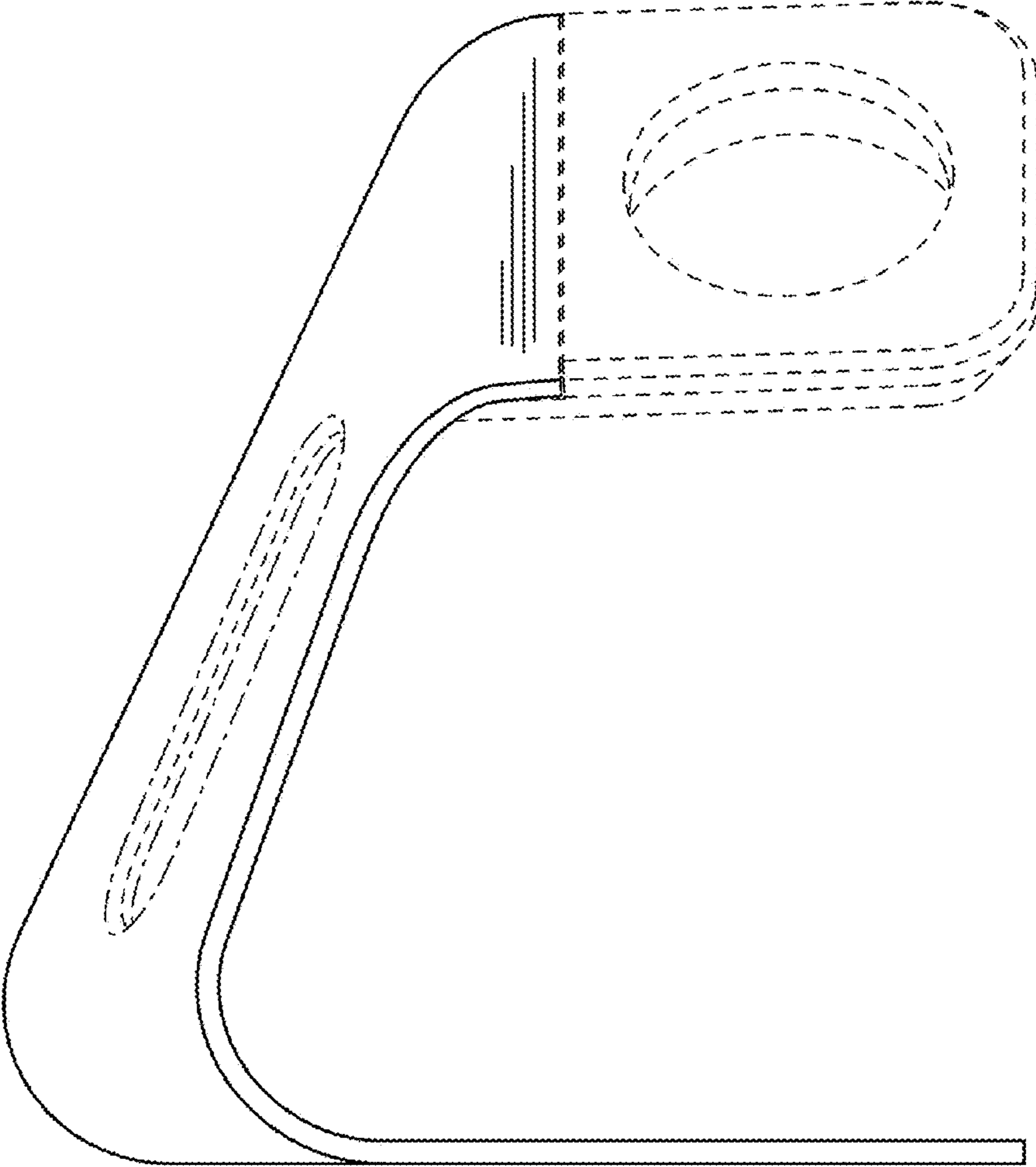

FIG. 4

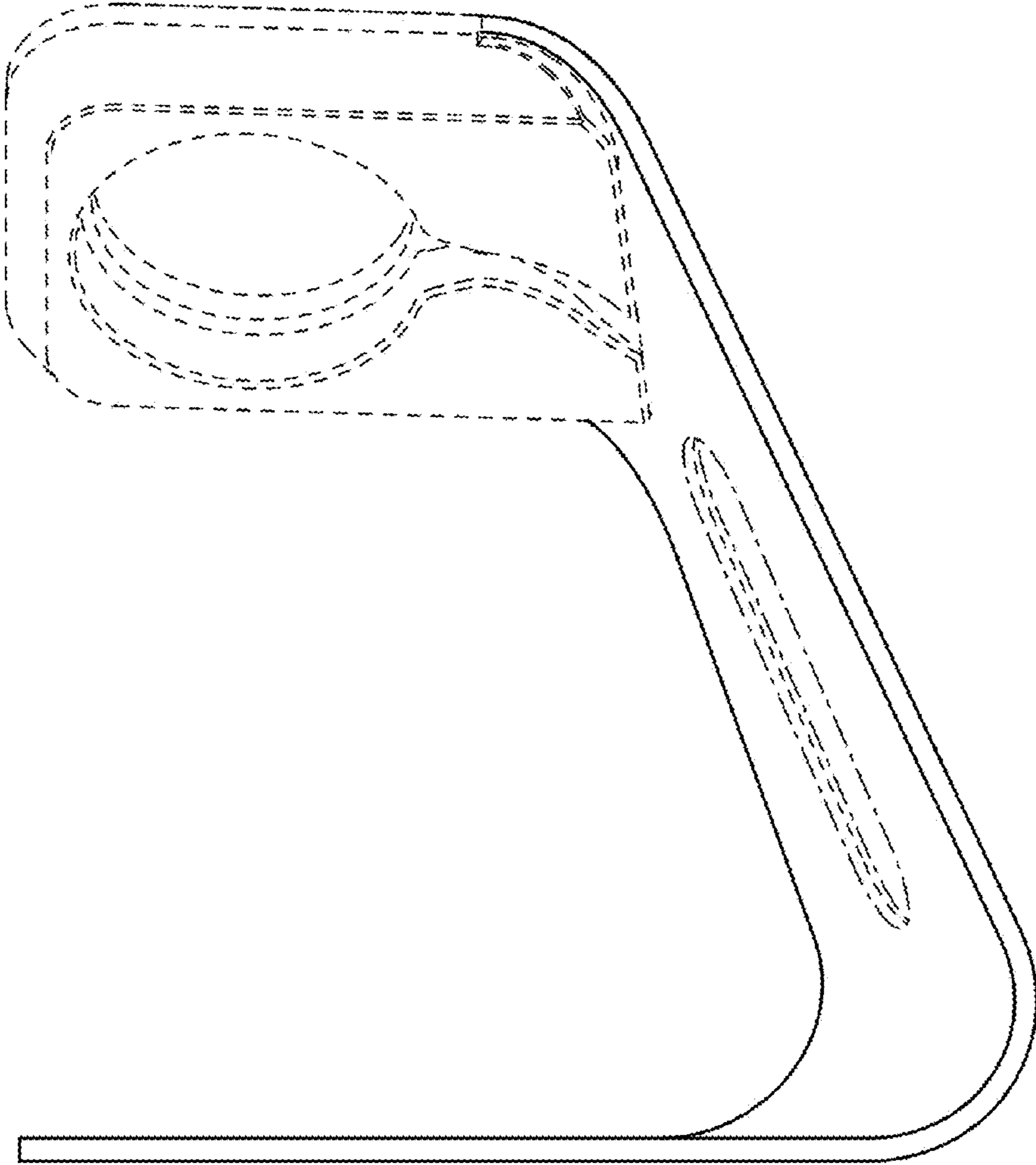

FIG. 5

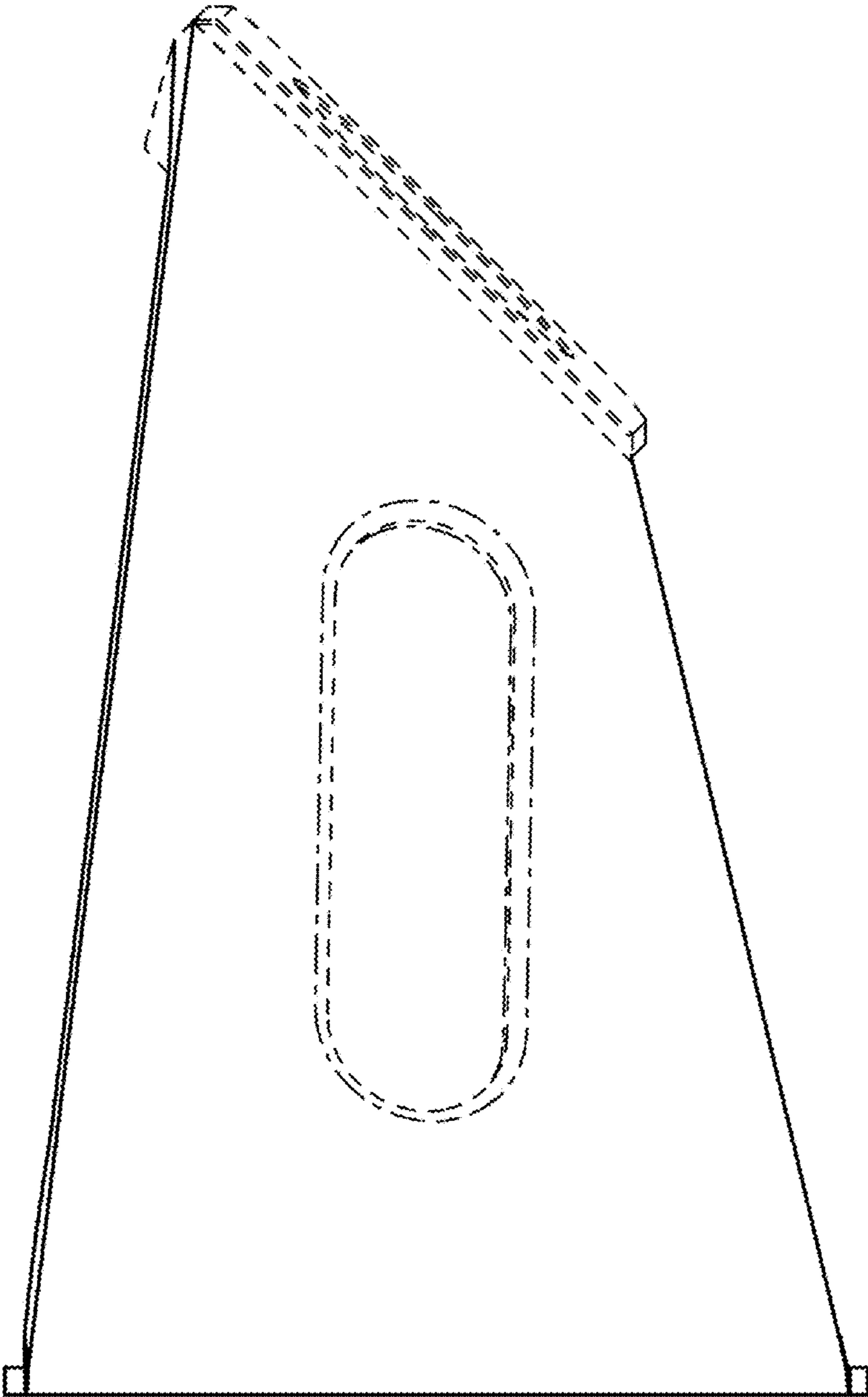

FIG. 6

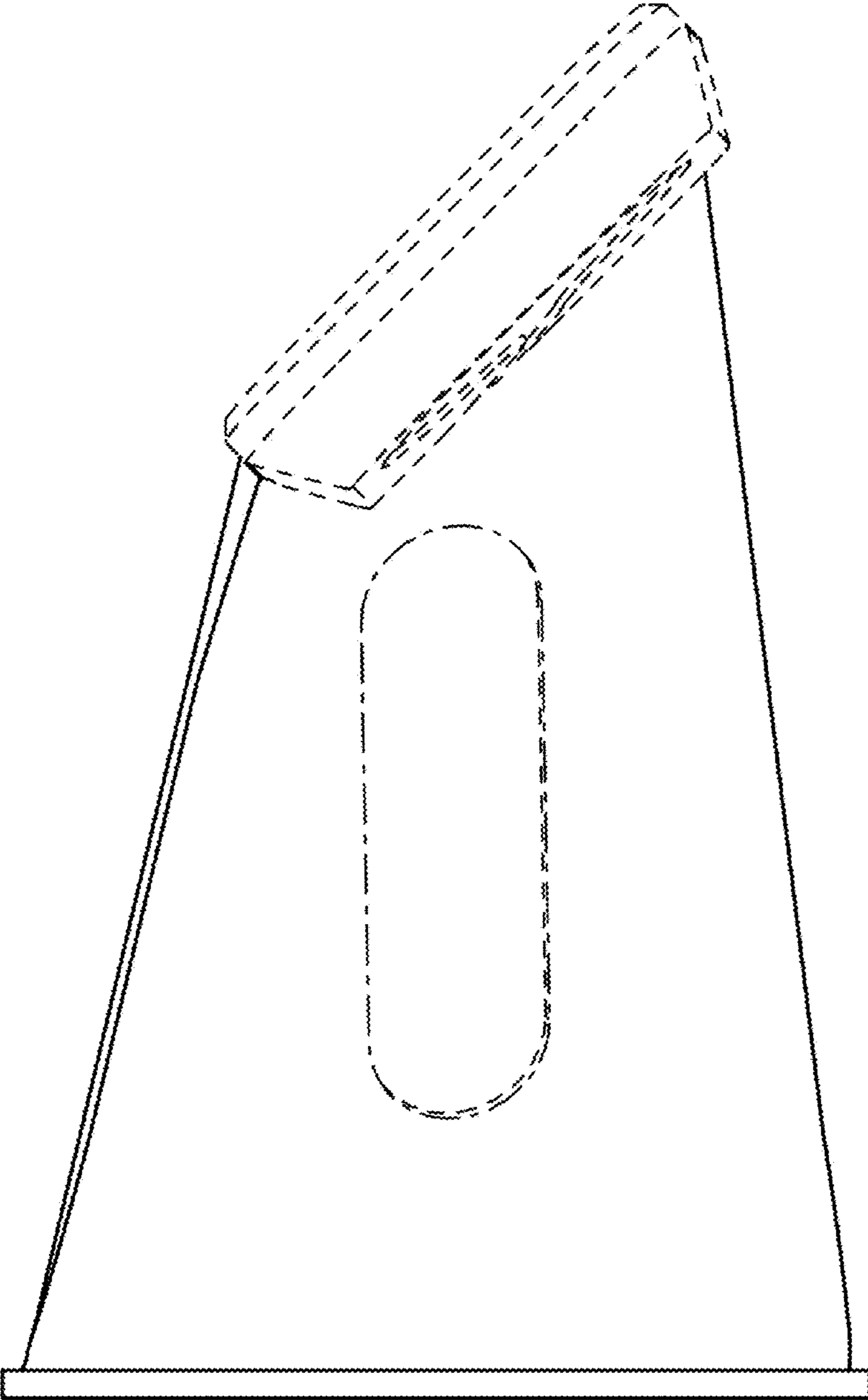



FIG. 7

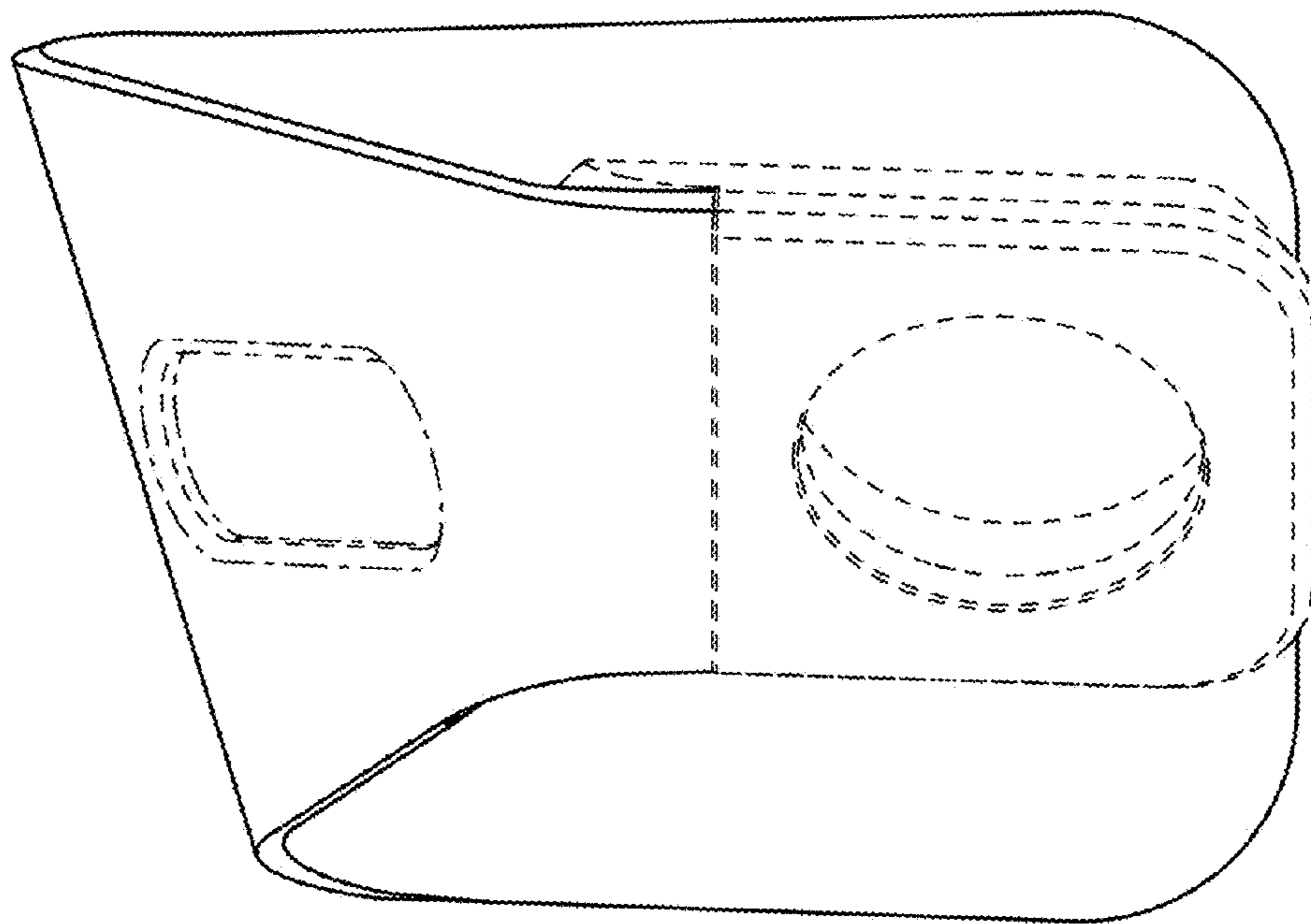

FIG. 8

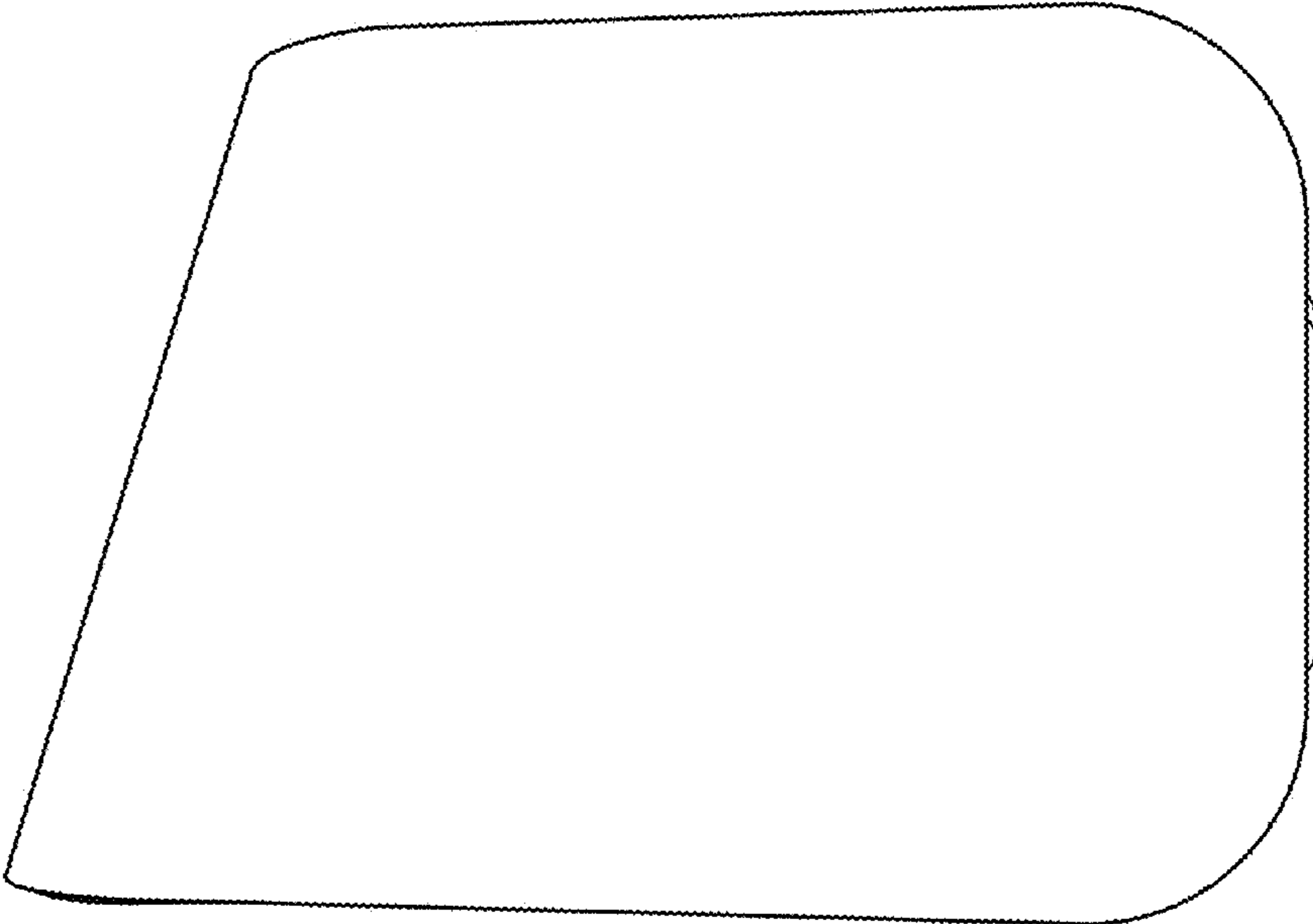

FIG. 9

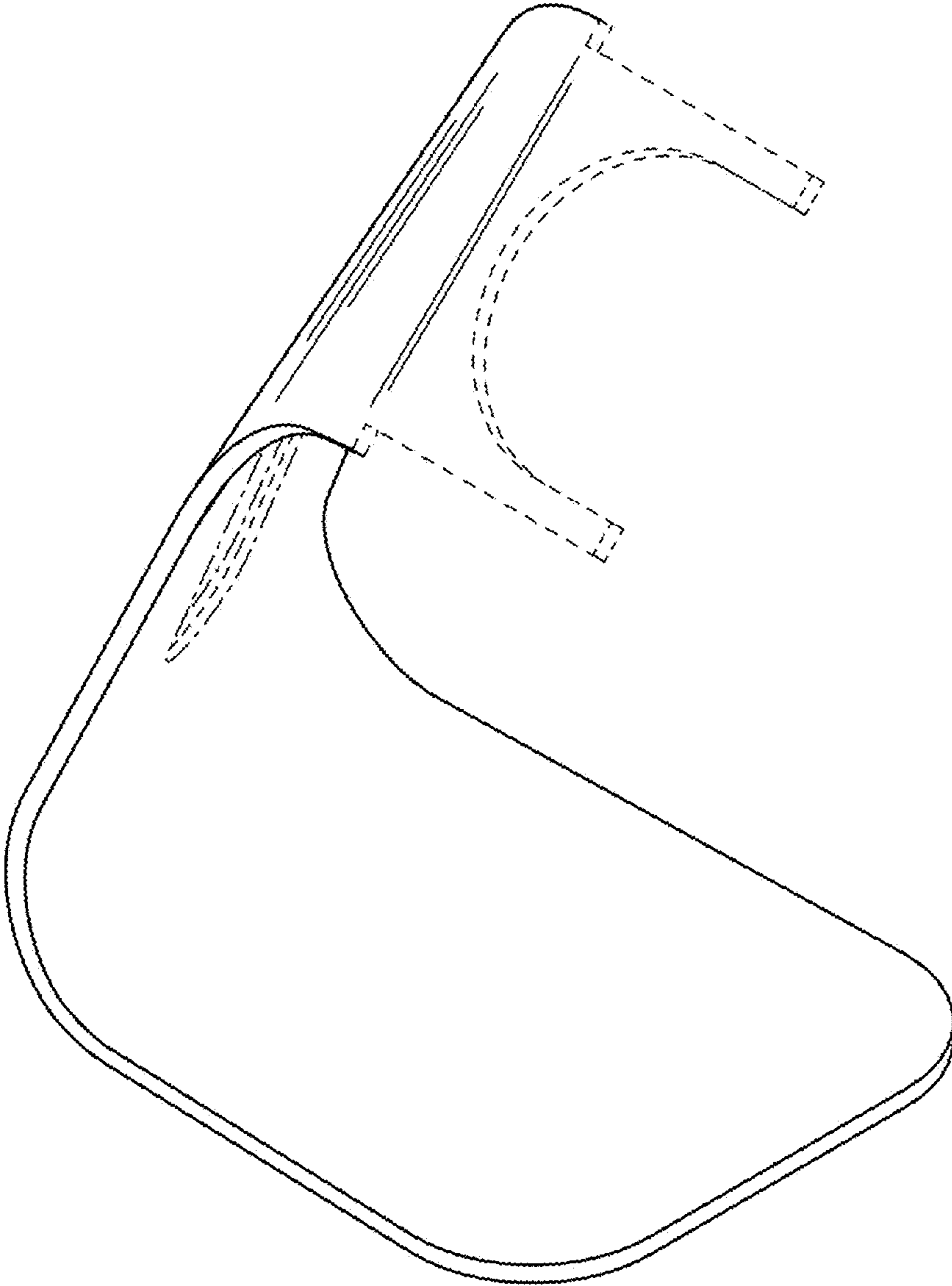

FIG. 10

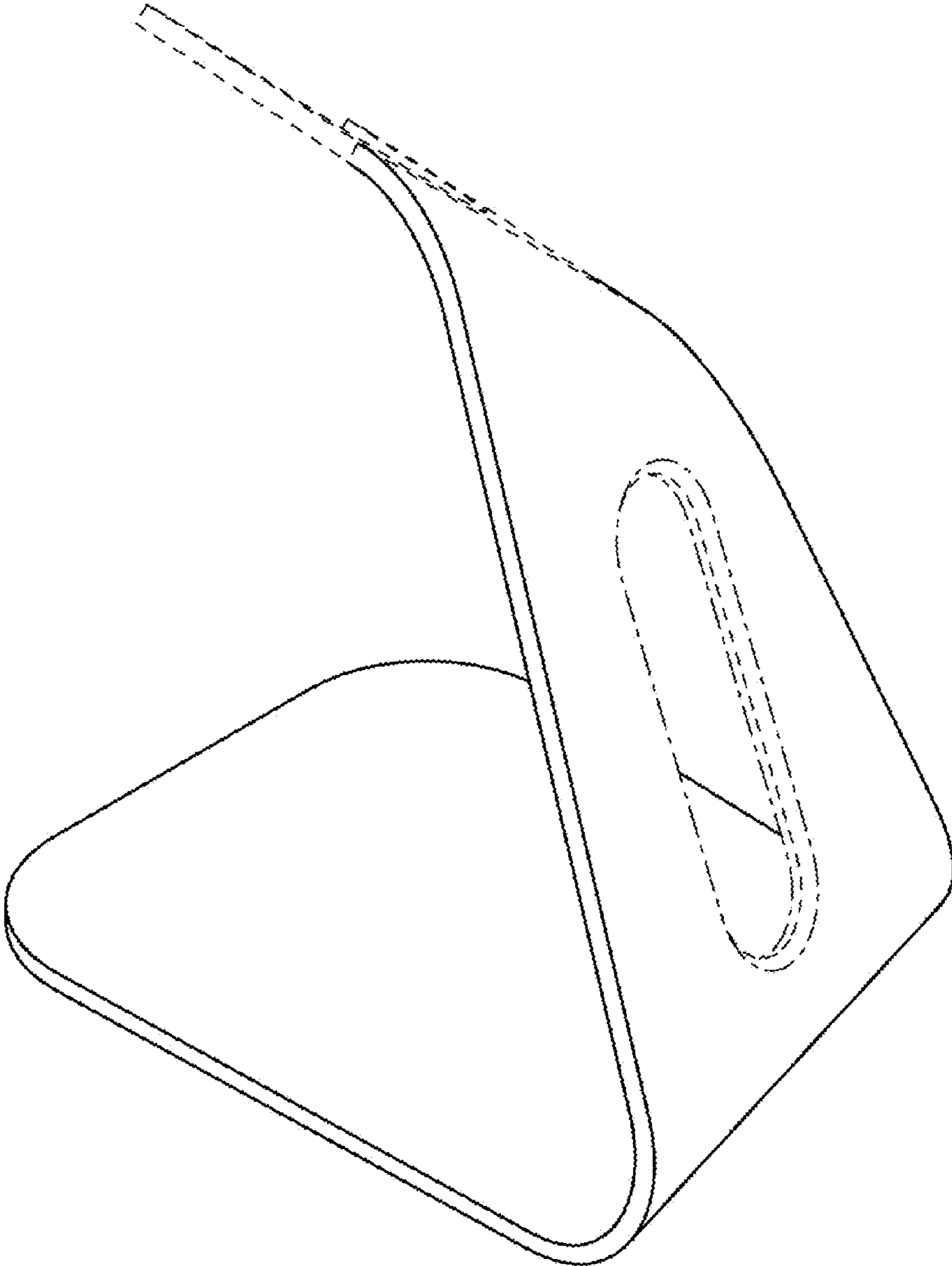

FIG. 11

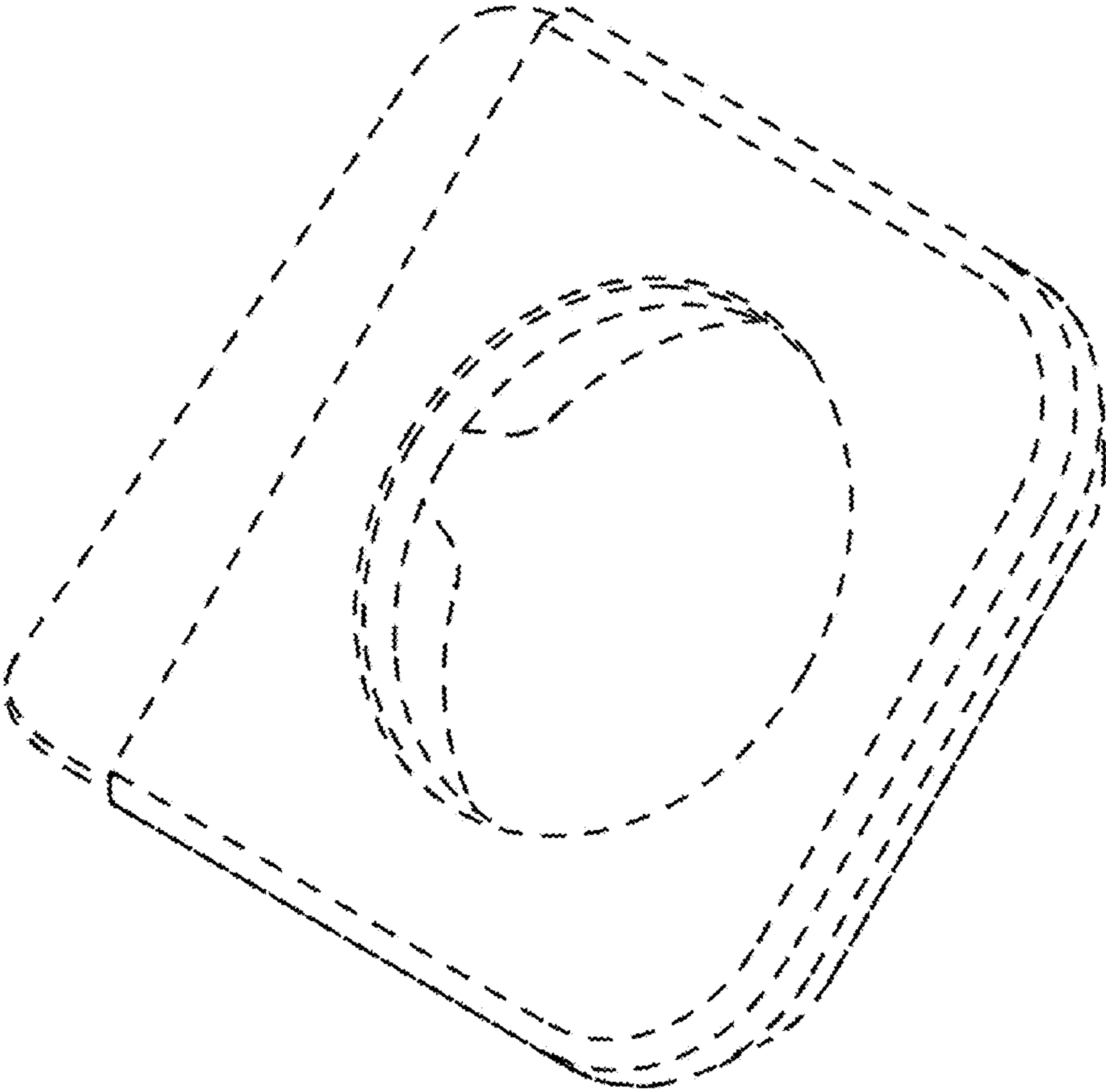

FIG. 12

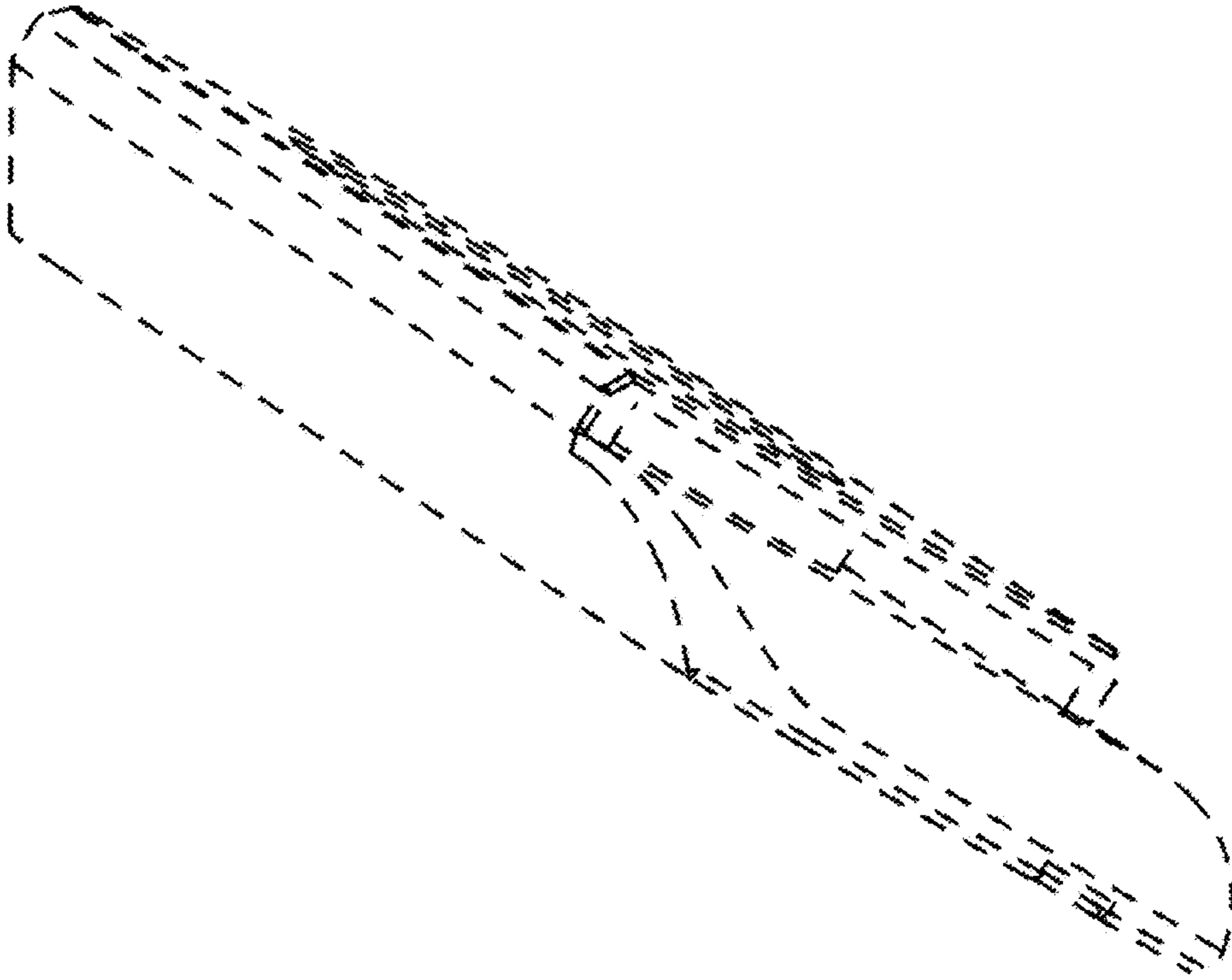

FIG. 13

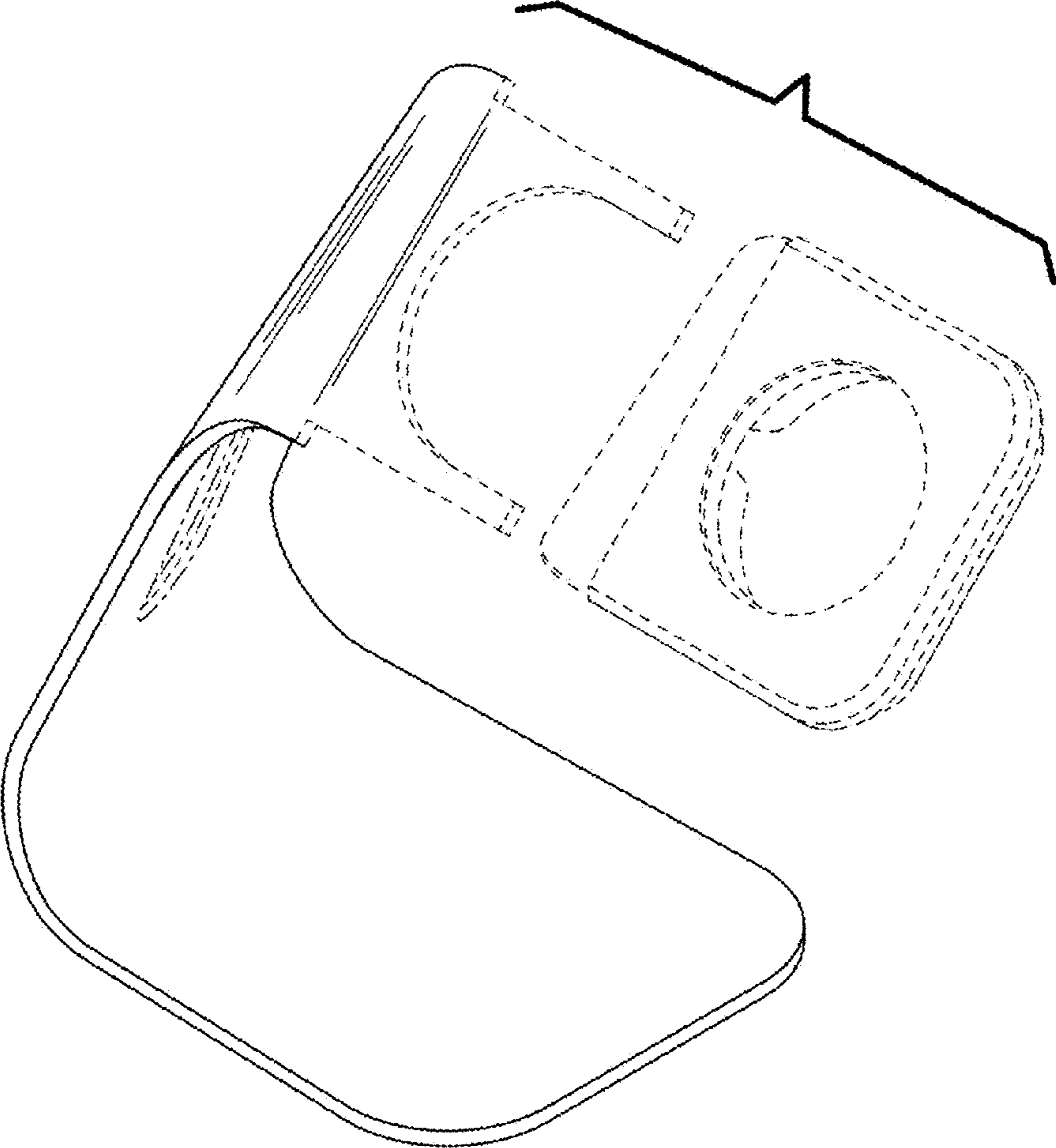

FIG. 14

