



US00D816630S

(12) **United States Design Patent** (10) **Patent No.:** **US D816,630 S**  
**Lee et al.** (45) **Date of Patent:** **\*\* \*May 1, 2018**

(54) **TV RECEIVER**

CPC ... G06F 1/1601; G06F 1/1643; H05K 5/0004;  
H05K 5/0017; H05K 5/02; H05K 5/0217  
See application file for complete search history.

(71) Applicant: **LG ELECTRONICS INC.**, Seoul  
(KR)

(56) **References Cited**

(72) Inventors: **Yongho Lee**, Seoul (KR); **Jongchul Kim**, Seoul (KR); **Jeongrok Lee**, Seoul (KR); **Kyongtae Han**, Seoul (KR); **Sunggu Joe**, Seoul (KR)

U.S. PATENT DOCUMENTS

(73) Assignee: **LG ELECTRONICS INC.**, Seoul  
(KR)

D682,231	S	*	5/2013	Lee	.....	D14/126
D700,586	S	*	3/2014	Kim	.....	D14/126
D722,300	S	*	2/2015	Won	.....	D14/126
D733,082	S	*	6/2015	Hwangbo	.....	D14/126
D754,086	S	*	4/2016	Valeur	.....	D14/126
D768,100	S	*	10/2016	Seo	.....	D14/126
D772,830	S	*	11/2016	Kim	.....	D14/126
D774,483	S	*	12/2016	Kim	.....	D14/126
D774,484	S	*	12/2016	Han	.....	D14/126
D775,094	S	*	12/2016	Kim	.....	D14/126
D778,854	S	*	2/2017	Lee	.....	D14/126
D780,140	S	*	2/2017	Kim	.....	D14/126
D790,493	S	*	6/2017	Han	.....	D14/126

(\*) Notice: This patent is subject to a terminal disclaimer.

\* cited by examiner

(\*\*) Term: **15 Years**

*Primary Examiner* — Michael A. Pratt

(21) Appl. No.: **35/501,873**

(74) *Attorney, Agent, or Firm* — Birch, Stewart, Kolasch & Birch, LLP

(22) Filed: **May 11, 2016**

(80) **Hague Agreement Data**

(57) **CLAIM**

Int. Filing Date: **May 11, 2016**  
Int. Reg. No.: **DM/092573**  
Int. Reg. Date: **May 11, 2016**  
Int. Reg. Pub. Date: **Nov. 11, 2016**

The ornamental design for a TV receiver, as shown and described.

(30) **Foreign Application Priority Data**

**DESCRIPTION**

Nov. 13, 2015 (KR) ..... 30-2015-0057345

(51) **LOC (11) Cl.** ..... **14-03**

(52) **U.S. Cl.**  
USPC ..... **D14/126**

(58) **Field of Classification Search**  
USPC ..... D14/126, 127, 128, 336, 448

- 1. TV receiver
- 1.1 : Perspective
- 1.2 : Front
- 1.3 : Back
- 1.4 : Left
- 1.5 : Right
- 1.6 : Top
- 1.7 : Bottom
- 1.8 : Enlarged
- 1.9 : Enlarged

(Continued)

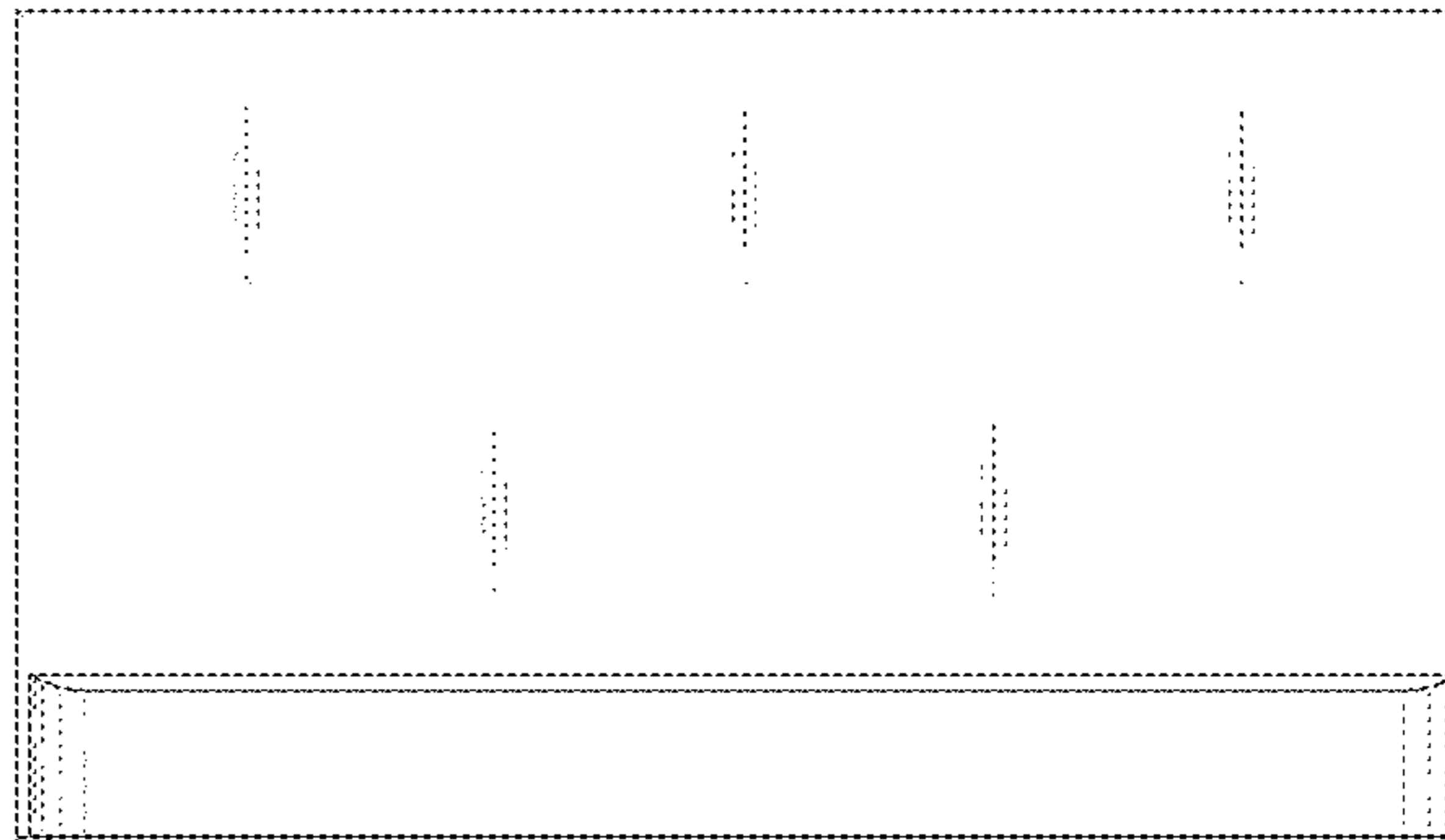
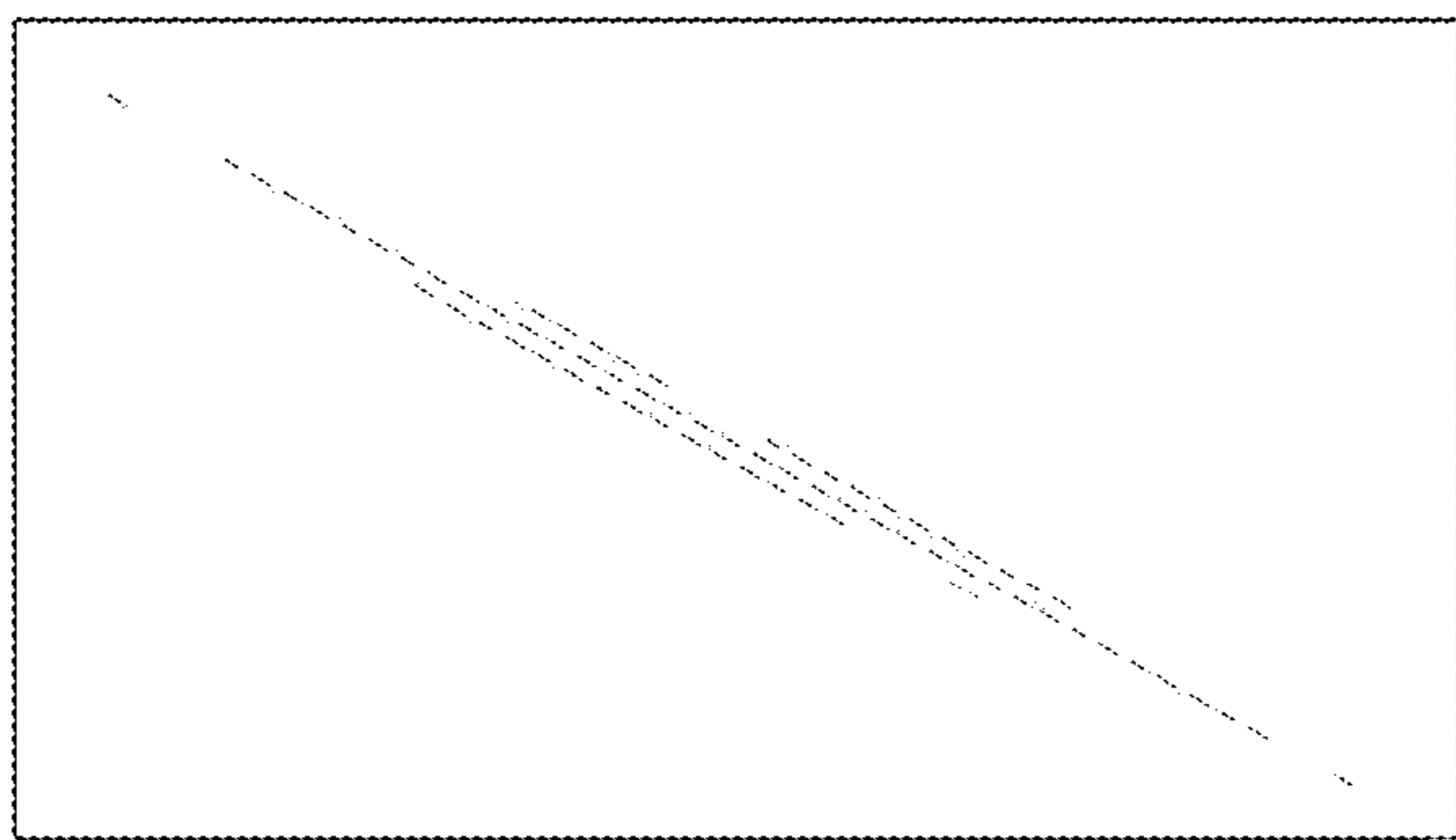

The gist of the present ornamental design is a combination of shape and pattern of "TV receiver" as shown and described.

**1 Claim, 9 Drawing Sheets**

1.1

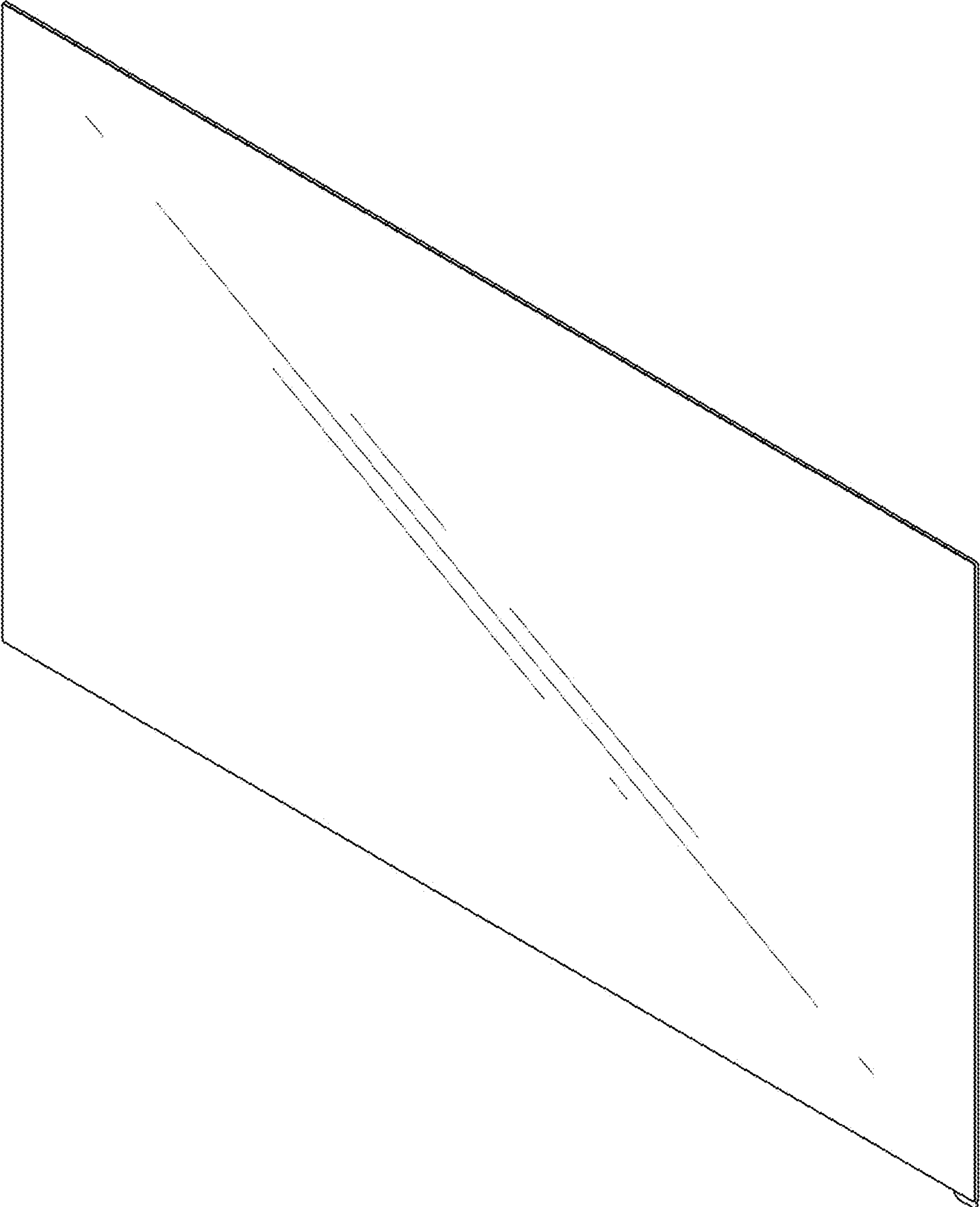

1.2

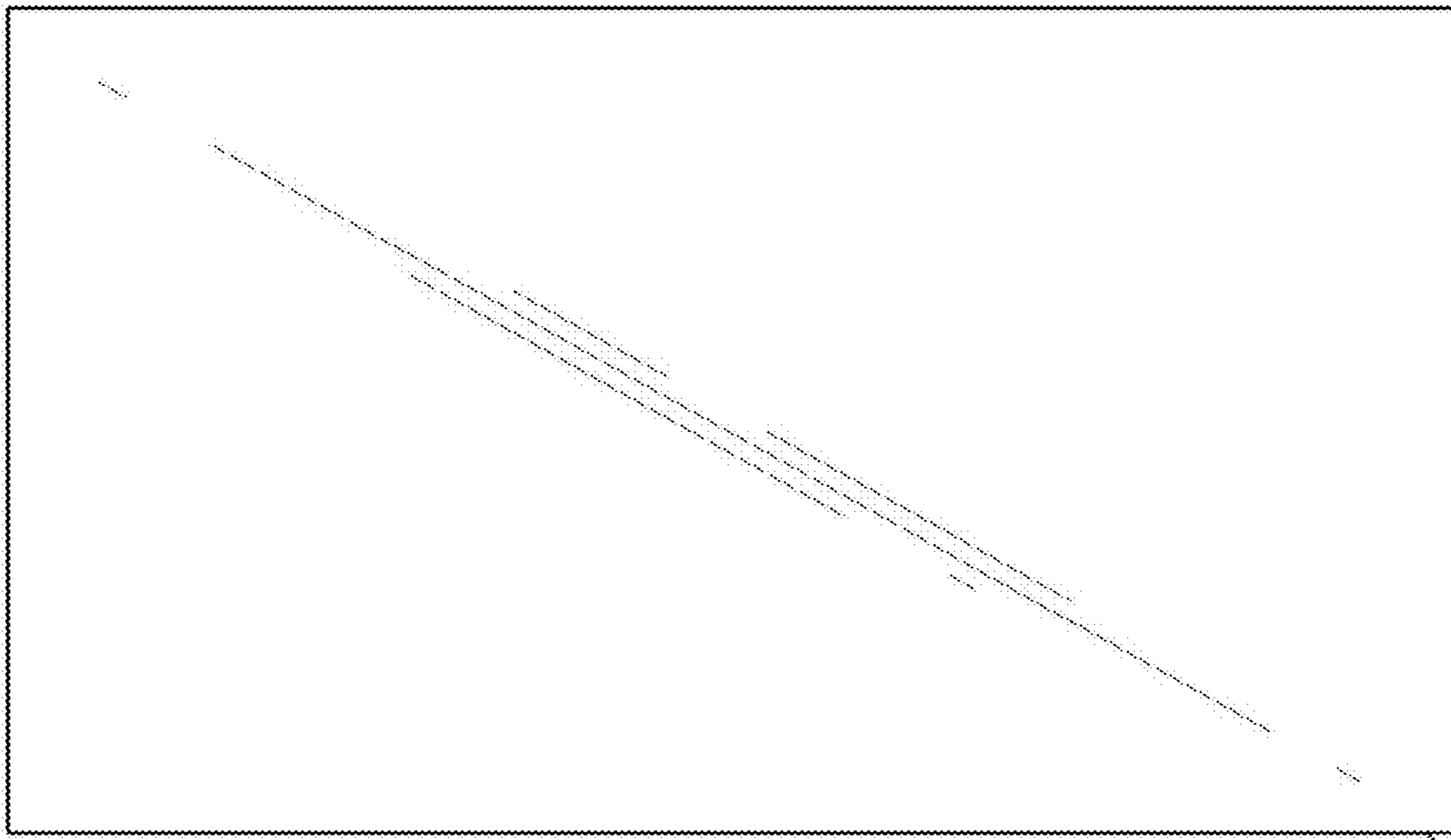

1.3

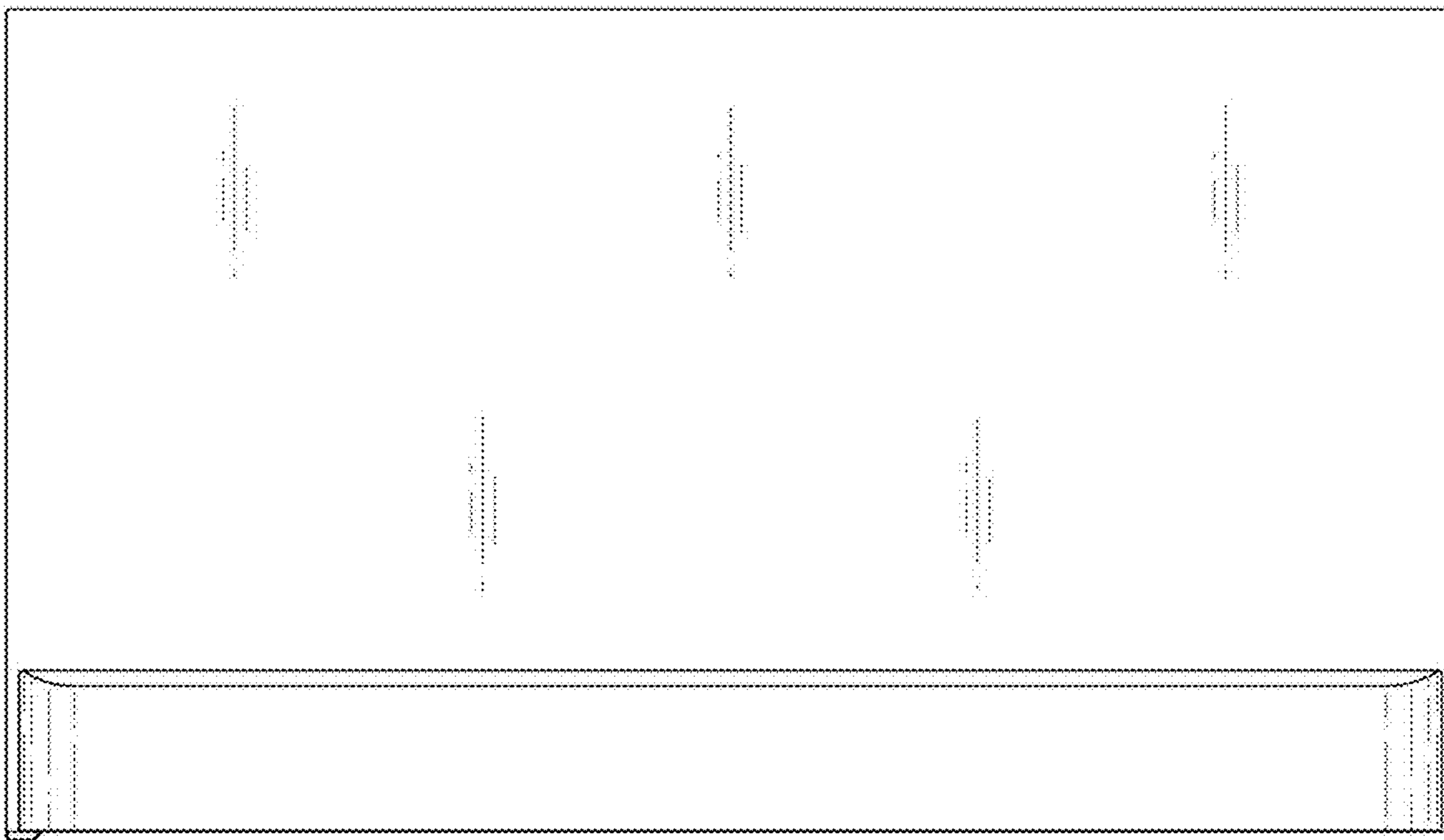

1.4



1.5

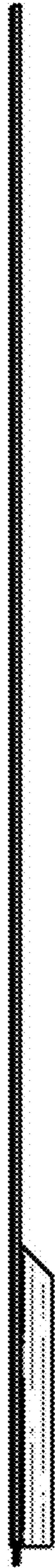

1.6

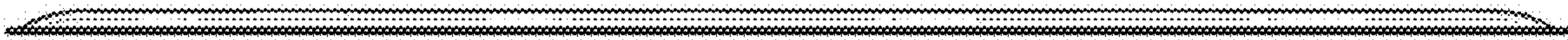



**1.7**

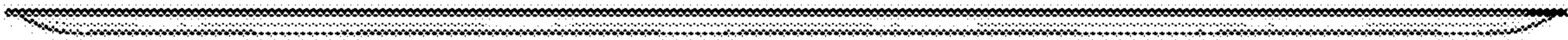

1.8

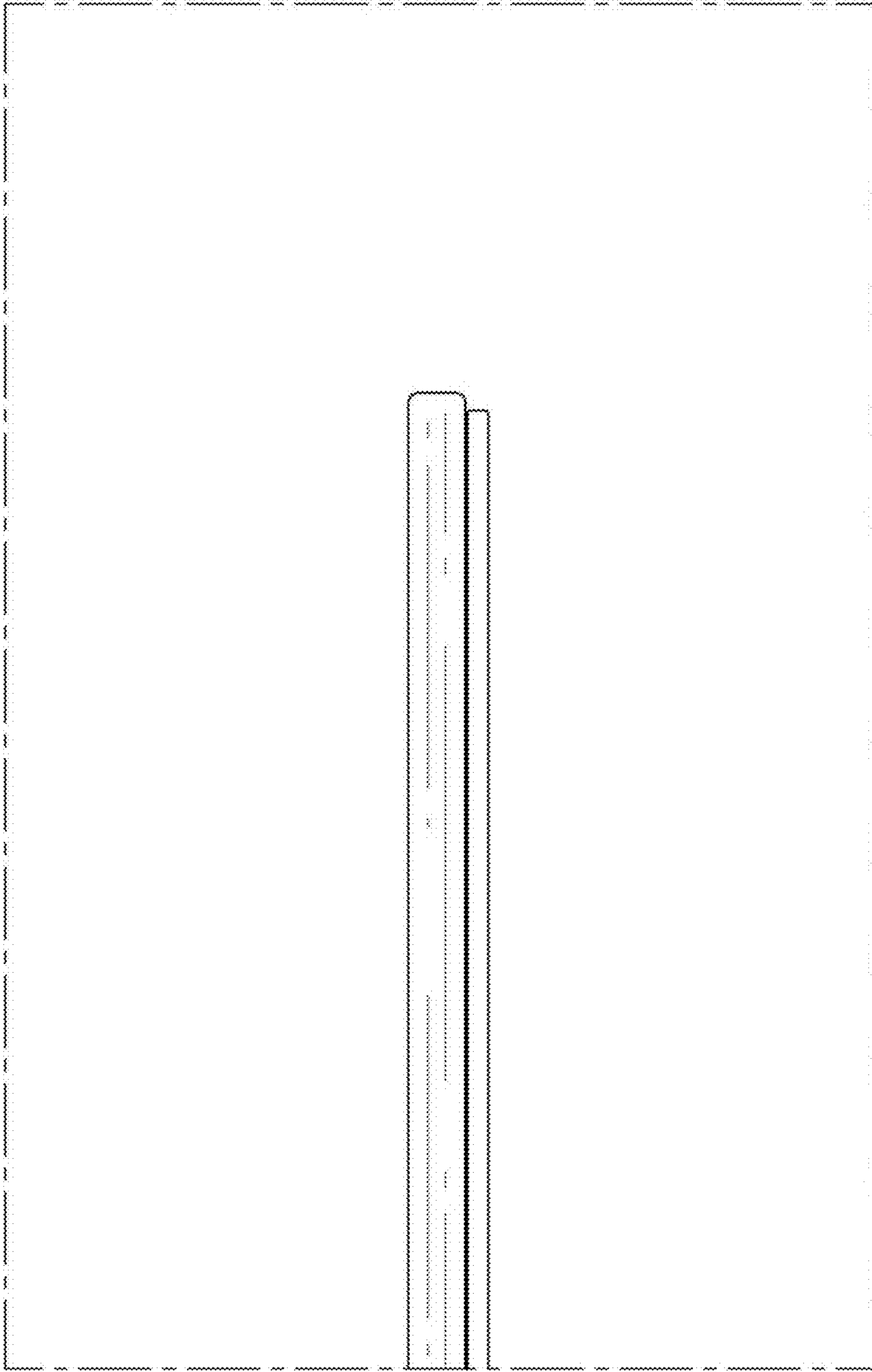

1.9

