



US00D816606S

(12) **United States Design Patent**
Georgiades

(10) **Patent No.:** **US D816,606 S**

(45) **Date of Patent:** **** May 1, 2018**

(54) **PORTABLE BATTERY CHARGER**

(71) Applicant: **Molonlave Group LLC**, Long Island City, NY (US)

(72) Inventor: **Athos Georgiades**, Saddle River, NJ (US)

(73) Assignee: **MOLONLAVE GROUP LLC**, Long Island City, NY (US)

(**) Term: **15 Years**

(21) Appl. No.: **29/582,349**

(22) Filed: **Oct. 27, 2016**

(51) **LOC (11) Cl.** **13-02**

(52) **U.S. Cl.**
USPC **D13/108; D13/103**

(58) **Field of Classification Search**
USPC D13/102-110, 118-119, 184, 199;
D14/356, 432

CPC Y02E 60/10; Y02E 60/12; Y02E 60/122;
Y02E 60/124; Y02E 60/50; H01M 2/02;
H01M 2/022; H01M 2/0202; H01M
2/0207; H01M 2/0212; H01M 2/1061;
H01M 2/1022; H01M 2/1055; H01M
2/1066; H01M 2/105; H01M 2/20; H01M
2/204; H01M 2/206; H01M 10/44; H01M
10/46; H01M 10/465; H01M 10/482;
H01M 2200/30; H01M 2250/30; H01M
2250/40; H02J 7/00; H02J 7/0003; H02J
7/0011; H02J 7/0013; H02J 7/0054; H02J
7/0055; H02J 7/0057; H02J 2007/0062

See application file for complete search history.

(56) **References Cited**

U.S. PATENT DOCUMENTS

D600,640 S * 9/2009 Stein D13/103
D654,850 S * 2/2012 Obata D13/103

D683,305 S * 5/2013 Gupta D13/103
D721,687 S * 1/2015 To D14/250
D723,530 S * 3/2015 Namminga D14/250
D767,485 S * 9/2016 To D13/103
D769,877 S * 10/2016 Akana D14/433
9,746,881 B2 * 8/2017 Owens, Jr. G06F 1/1632
D796,514 S * 9/2017 Xu D14/433
D797,040 S * 9/2017 Lavin, Jr. D13/103
D797,747 S * 9/2017 Xu D14/433
D797,751 S * 9/2017 Houston D14/420
2004/0057199 A1 * 3/2004 Azuchi G06F 1/1626
361/679.3

* cited by examiner

Primary Examiner — Rosemary K Tarcza

Assistant Examiner — Nathaniel D. Buckner

(74) *Attorney, Agent, or Firm* — Ladas & Parry LLP

(57) **CLAIM**

The ornamental design for a portable battery charger, as shown and described.

DESCRIPTION

FIG. 1 is a perspective view of a portable battery charger showing the new design;

FIG. 2 is a front elevation view thereof;

FIG. 3 is rear plan view thereof;

FIG. 4 is a right side elevation view thereof;

FIG. 5 is a left side elevation view thereof;

FIG. 6 is a top plan view thereof; and,

FIG. 7 is a bottom plan view thereof.

The broken lines in the figures represent portions of the article which form no part of the claimed design.

1 Claim, 5 Drawing Sheets

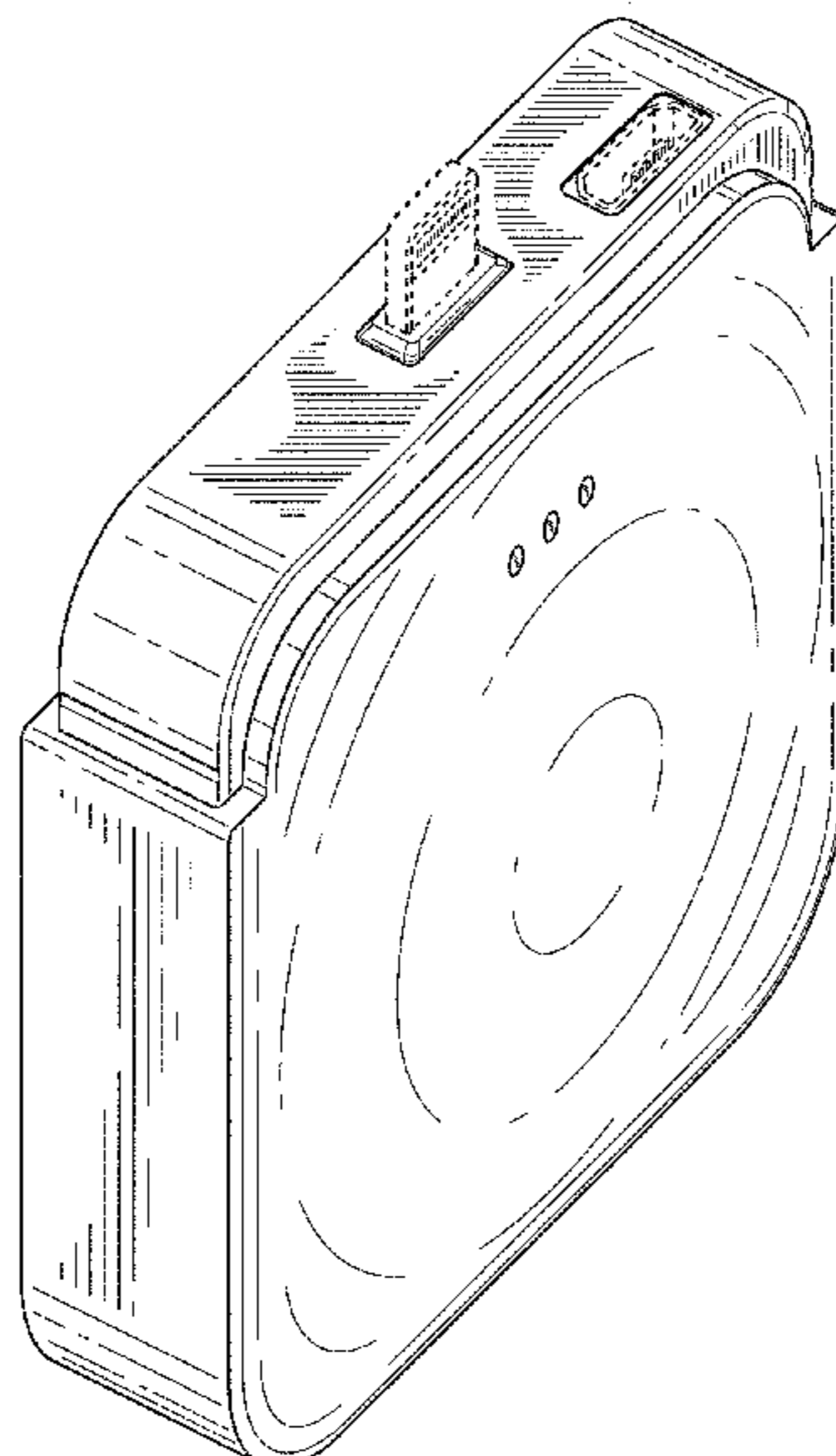

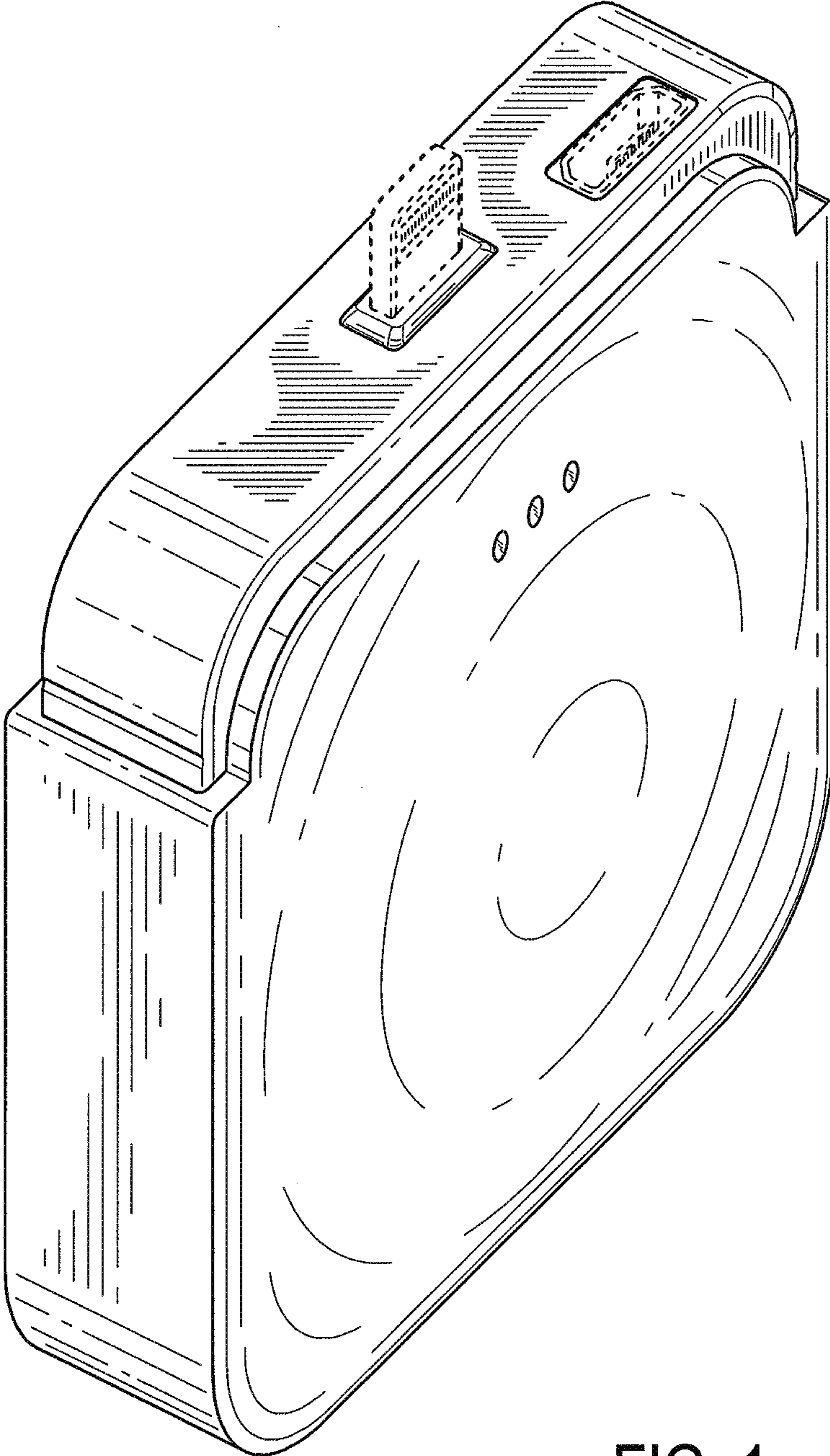

FIG. 1

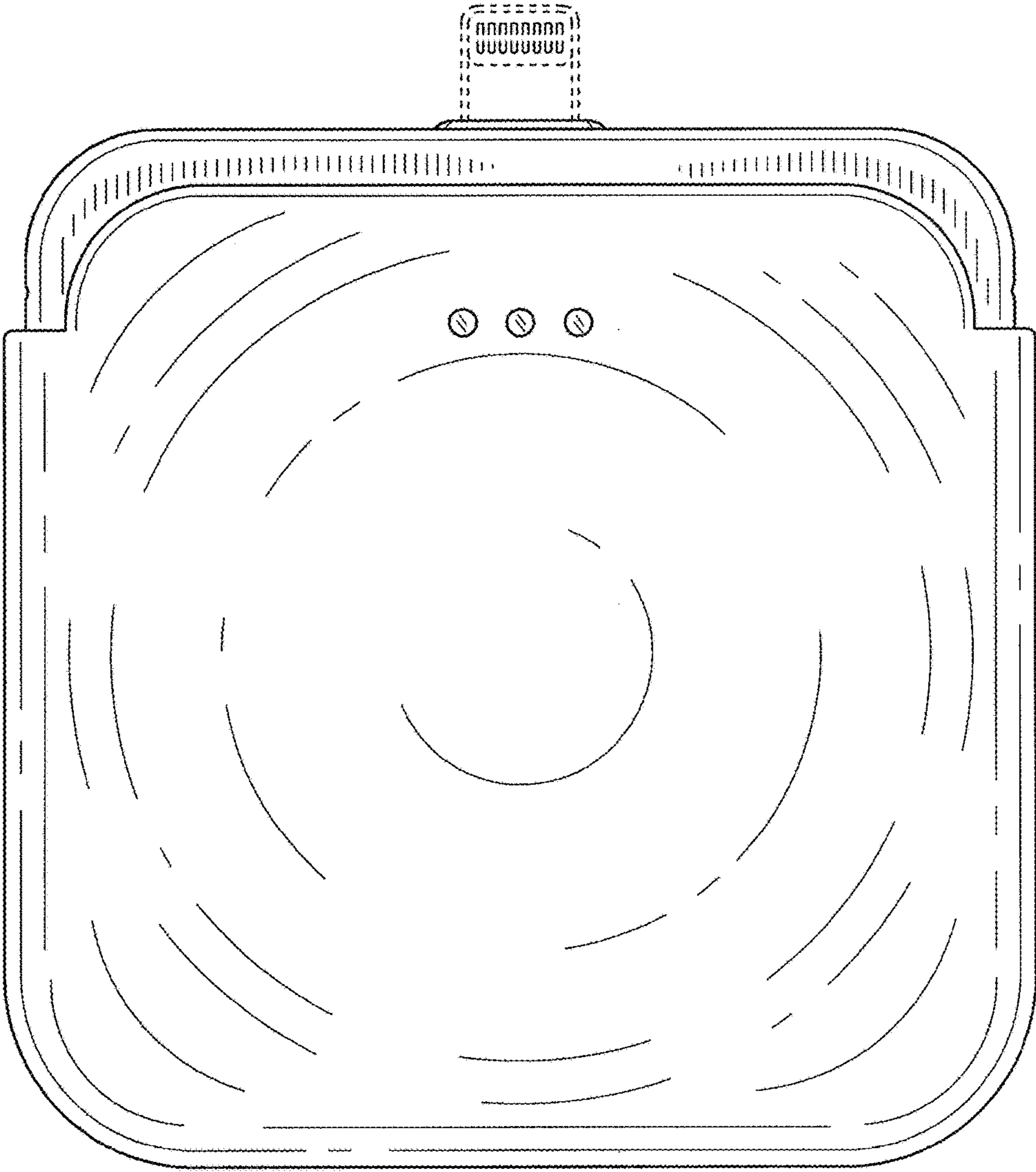

FIG. 2

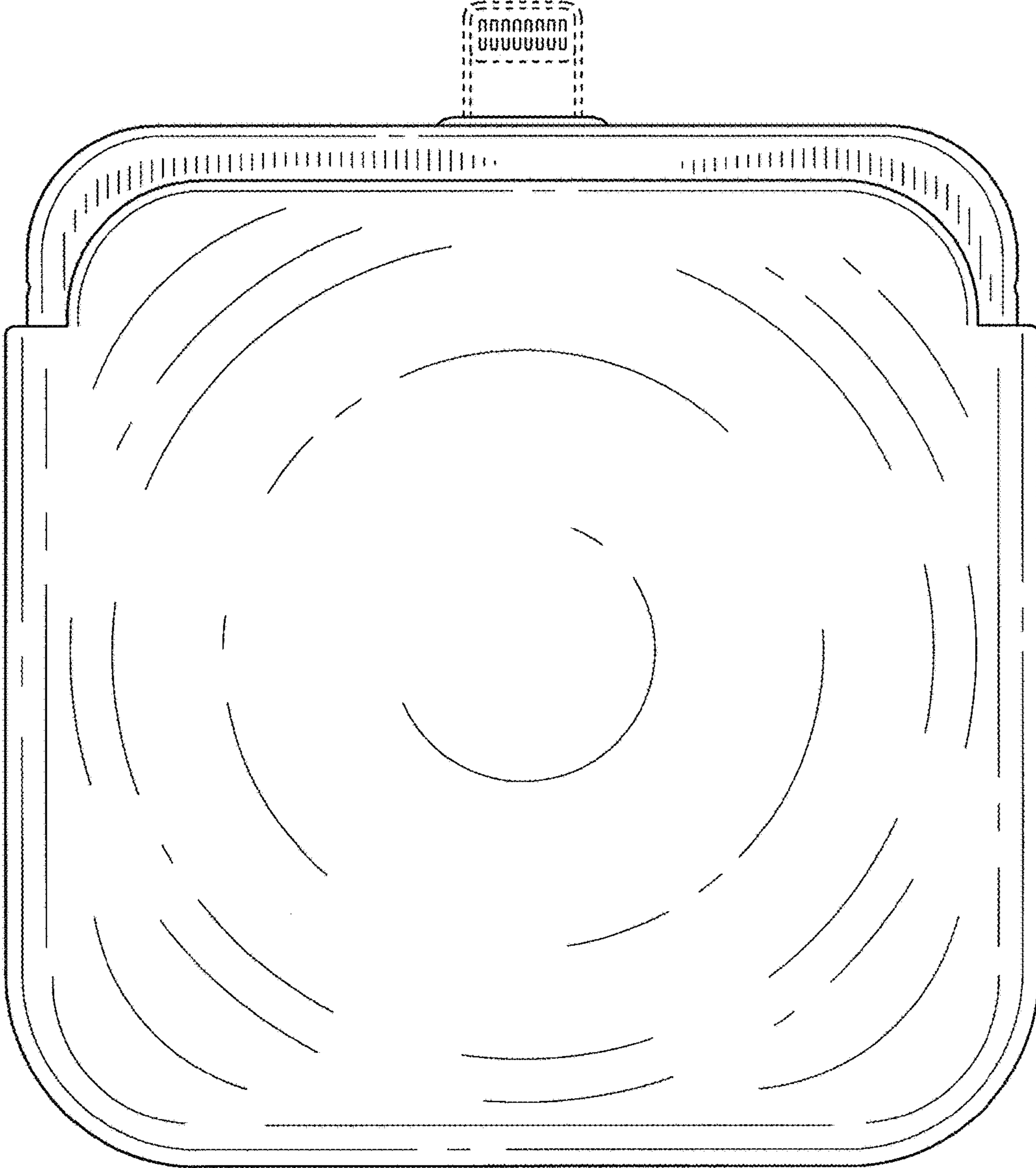

FIG. 3

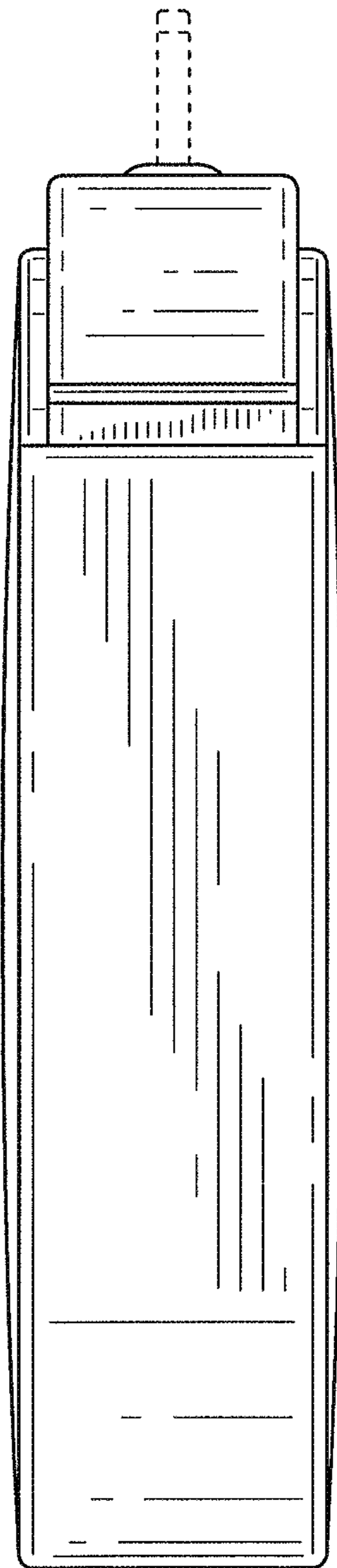

FIG. 4

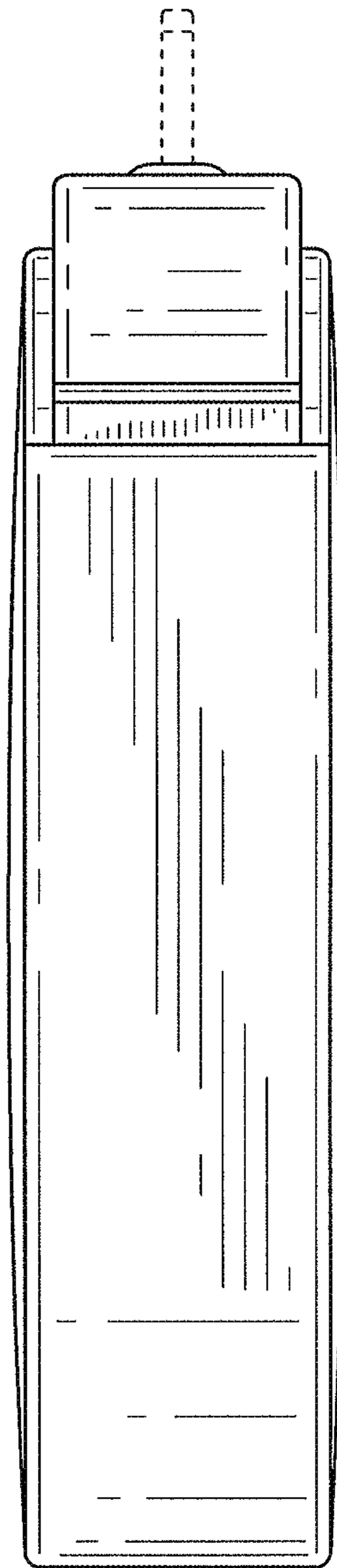

FIG. 5

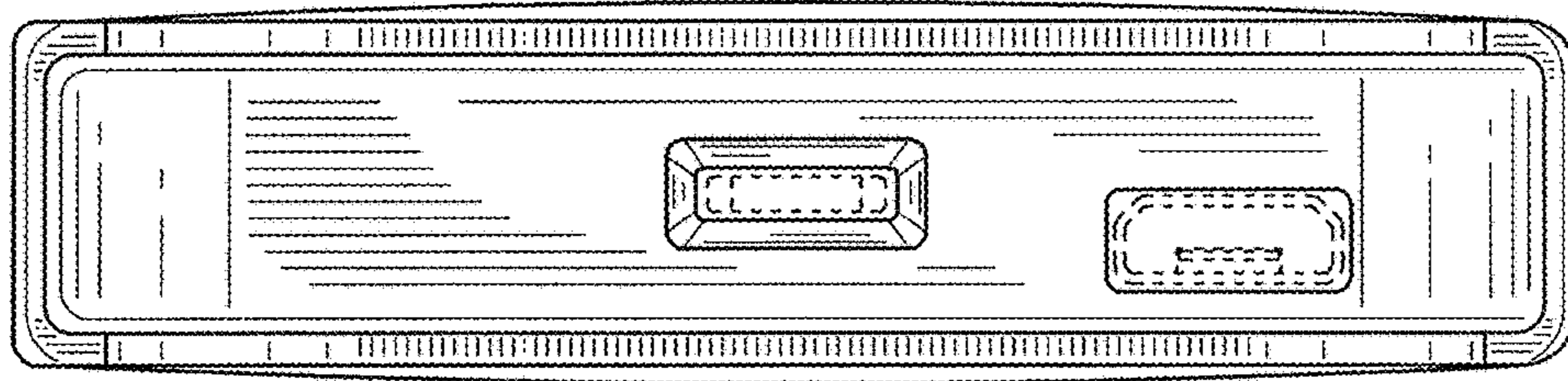

FIG. 6

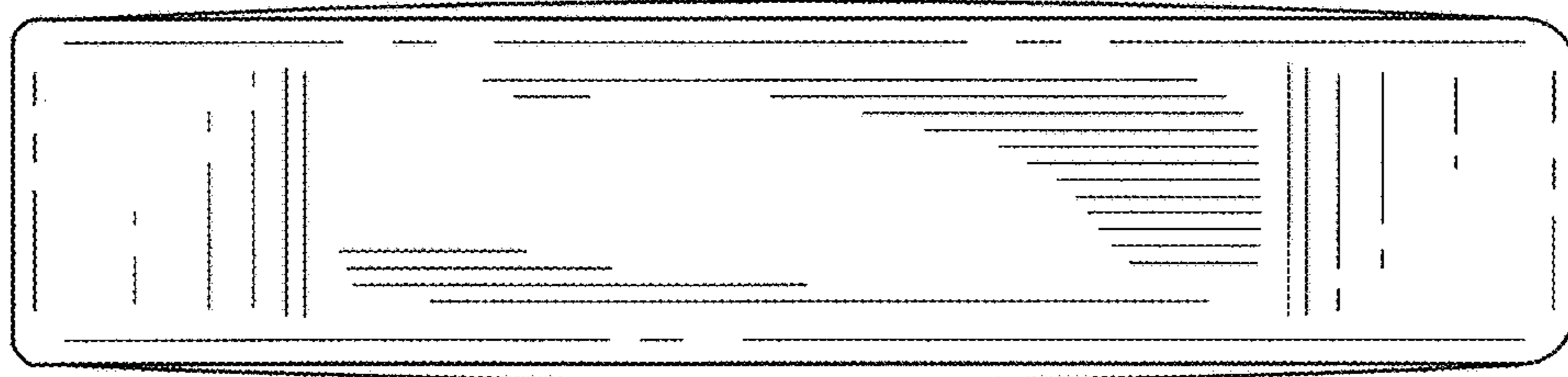

FIG. 7