



US00D816520S

(12) **United States Design Patent**
Elrod et al.

(10) **Patent No.:** **US D816,520 S**

(45) **Date of Patent:** **** May 1, 2018**

(54) **ENCLOSURE FOR MAIN UNIT OF VOLTAGE, CURRENT, OR TEMPERATURE SENSOR**

(71) Applicant: **Fluke Electronics Corporation**,
Everett, WA (US)

(72) Inventors: **Jeffrey M. Elrod**, Seattle, WA (US);
Christopher W. Lagerberg, Everett,
WA (US); **Duncan N. Kearsley**,
Everett, WA (US)

(73) Assignee: **Fluke Electronics Corporation**,
Everett, WA (US)

(**) Term: **15 Years**

(21) Appl. No.: **29/597,622**

(22) Filed: **Mar. 17, 2017**

(51) **LOC (11) Cl.** **10-04**

(52) **U.S. Cl.**
USPC **D10/52; D10/53**

(58) **Field of Classification Search**
USPC D10/49, 50, 52, 53, 55, 56, 60, 104.1,
D10/106.6; D13/168, 184; D14/218
CPC .. F24F 11/001; F24F 11/0012; F24F 11/0032;
F24F 11/0086; F24F 2011/0057; F23N
2041/02; F23N 2025/12; G08B 3/10;
G08B 25/10; G08B 21/10; G08B 21/14;
G08B 21/16; G08B 21/18; G08B 29/145;
G08B 29/183; G05D 23/1902; G01N
33/0004; G01N 33/0037; G01N 33/0039;
(Continued)

(56) **References Cited**

U.S. PATENT DOCUMENTS

D527,666 S * 9/2006 Tal D10/106.6
D595,262 S * 6/2009 Nousiainen D14/206
(Continued)

Primary Examiner — Selina Sikder

(74) *Attorney, Agent, or Firm* — Seed IP Law Group LLP

(57) **CLAIM**

The ornamental design for an enclosure for a main unit of a voltage, current, or temperature sensor, as shown and described.

DESCRIPTION

FIG. 1 is a top front right perspective view of an enclosure for a main unit of a voltage, current, or temperature sensor showing our new design.

FIG. 2 is a bottom rear left perspective view thereof.

FIG. 3 is a front elevation view thereof.

FIG. 4 is a right side elevation view thereof.

FIG. 5 is a left side elevation view thereof.

FIG. 6 is a top plan view thereof.

FIG. 7 is a bottom plan view thereof.

FIG. 8 is a rear elevation view thereof.

FIG. 9 is a top front right perspective view of another embodiment of an enclosure for a main unit of a voltage, current, or temperature sensor showing our new design.

FIG. 10 is a bottom rear left perspective view thereof.

FIG. 11 is a front elevation view thereof.

FIG. 12 is a right side elevation view thereof.

FIG. 13 is a left side elevation view thereof.

FIG. 14 is a top plan view thereof.

FIG. 15 is a bottom plan view thereof.

FIG. 16 is a rear elevation view thereof.

FIG. 17 is a top front right perspective view of another embodiment of an enclosure for a main unit of a voltage, current, or temperature sensor showing our new design.

FIG. 18 is a bottom rear left perspective view thereof.

FIG. 19 is a front elevation view thereof.

FIG. 20 is a right side elevation view thereof.

FIG. 21 is a left side elevation view thereof.

FIG. 22 is a top plan view thereof.

FIG. 23 is a bottom plan view thereof; and,

FIG. 24 is a rear elevation view thereof.

The broken lines in the figures illustrate environment only and form no part of the claimed design.

1 Claim, 18 Drawing Sheets

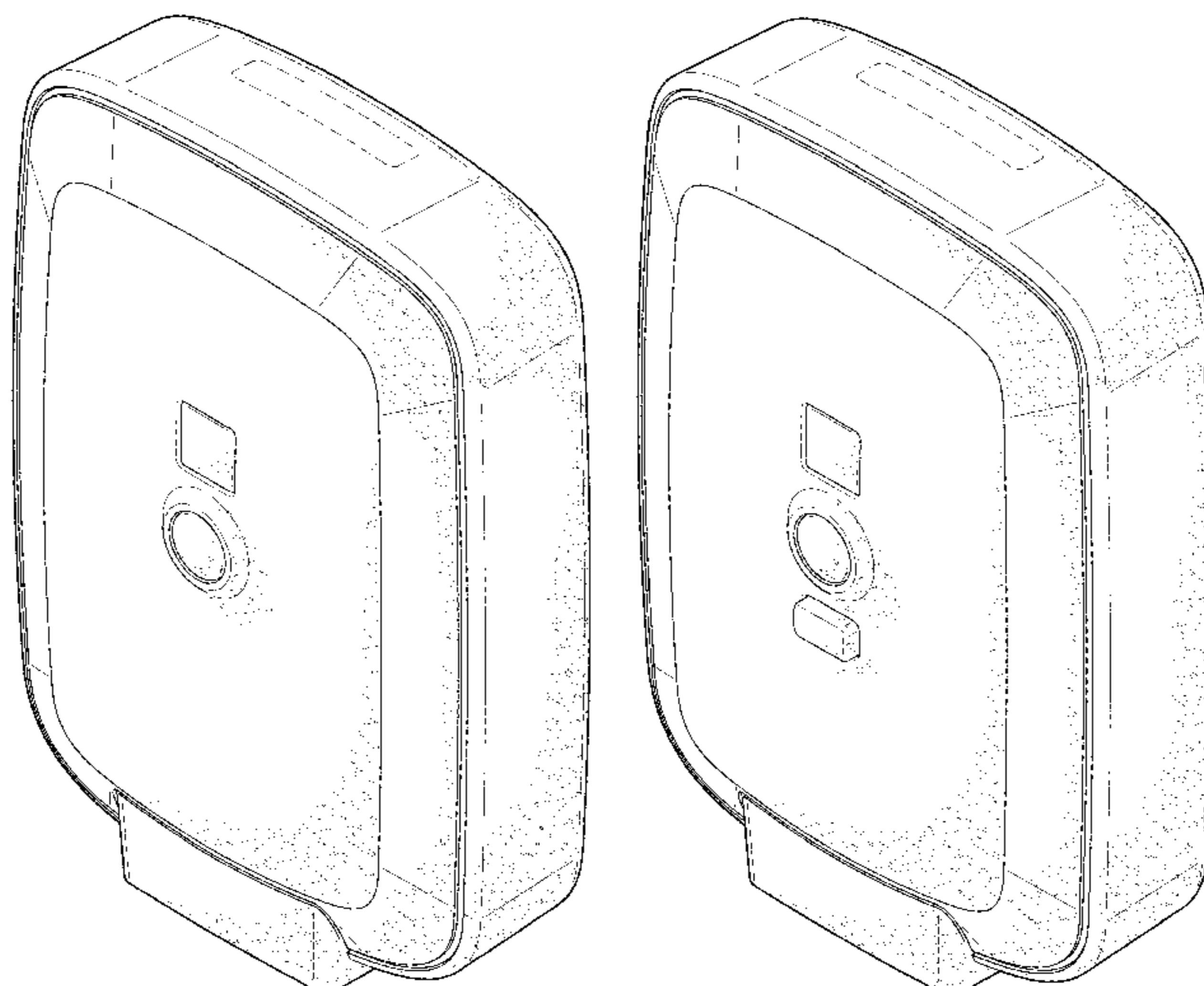

(58) **Field of Classification Search**

CPC G01N 33/004; G01N 33/0054; G01N
33/006; G01N 33/0075

See application file for complete search history.

(56) **References Cited**

U.S. PATENT DOCUMENTS

D609,221 S * 2/2010 Kim D14/218
D674,786 S * 1/2013 Park D14/240
D686,925 S * 7/2013 Gerold D10/53
D712,381 S * 9/2014 Hwang D14/218
D717,183 S * 11/2014 Herzl D10/53
D731,793 S * 6/2015 Houghton D3/294
9,046,414 B2 * 6/2015 Fadell G08B 17/00
D766,214 S * 9/2016 Mackiewicz D14/216
D766,749 S * 9/2016 Fadell D10/106.3
D782,354 S * 3/2017 Lovin D10/101
D783,423 S * 4/2017 Srnc D10/52
9,791,839 B2 * 10/2017 Matsuoka G05B 15/02
2011/0005057 A1 * 1/2011 Rosenblatt G08B 17/10
29/428
2017/0016773 A1 * 1/2017 Arai G01K 1/02

* cited by examiner

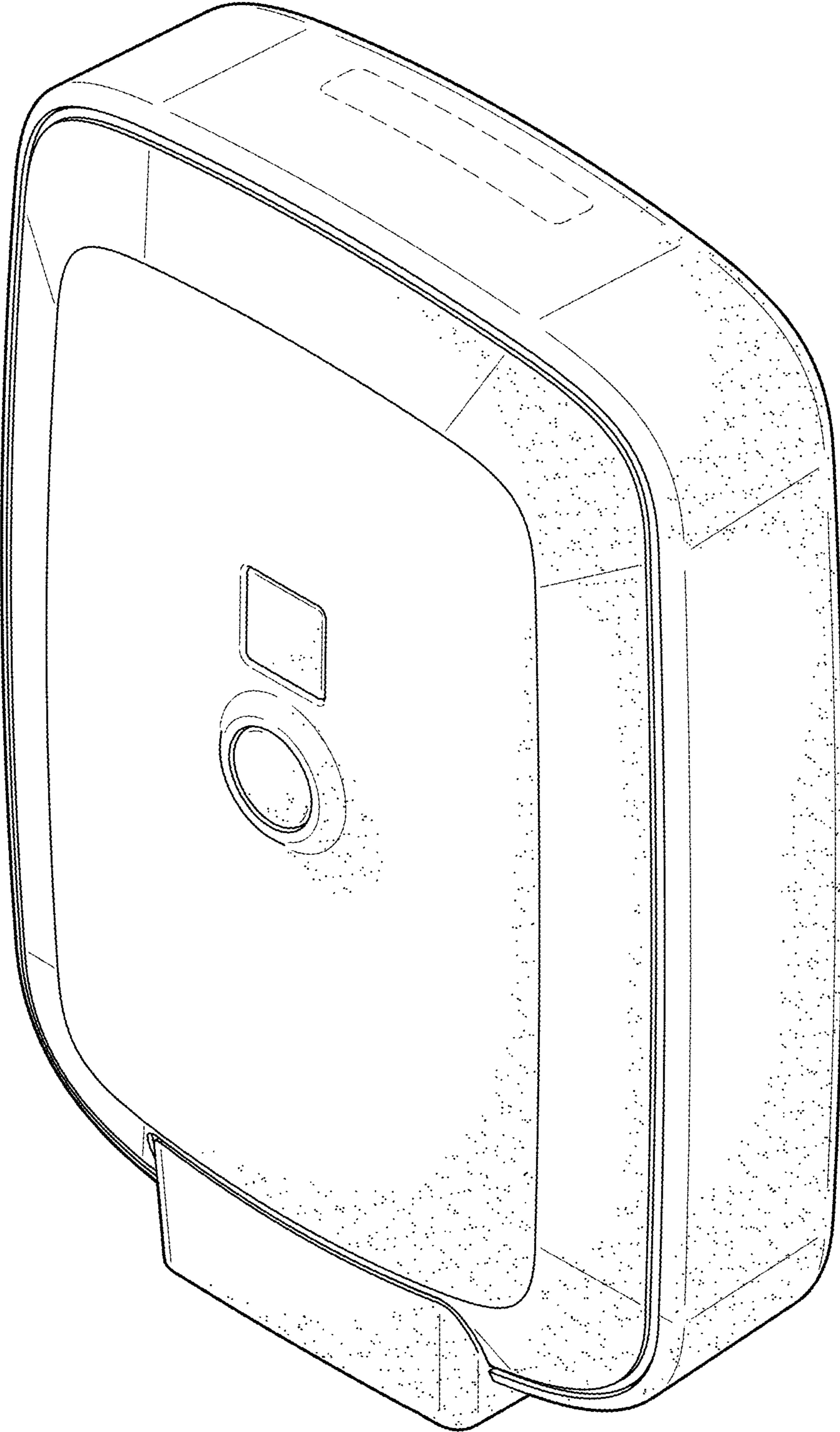

FIG. 1

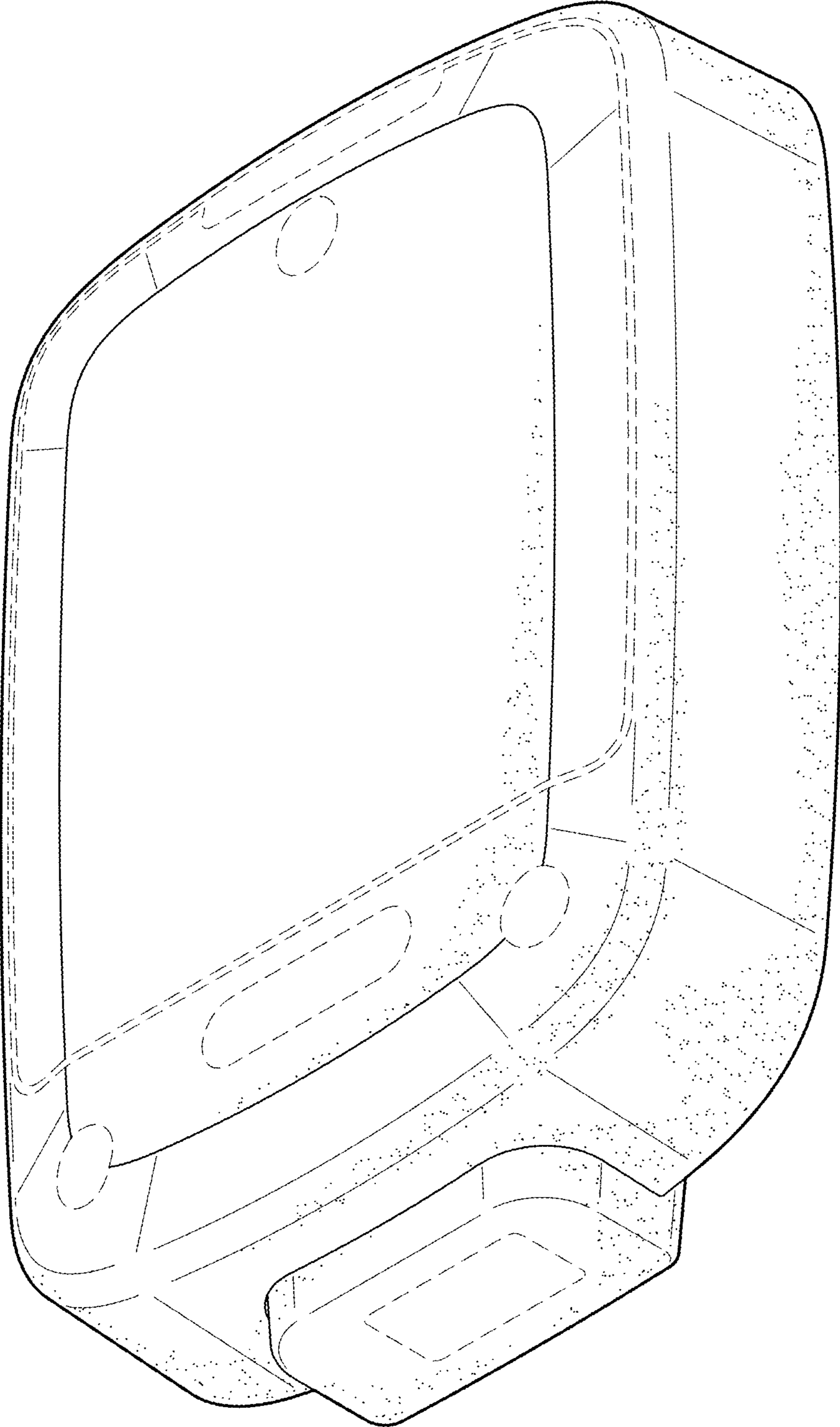

FIG. 2

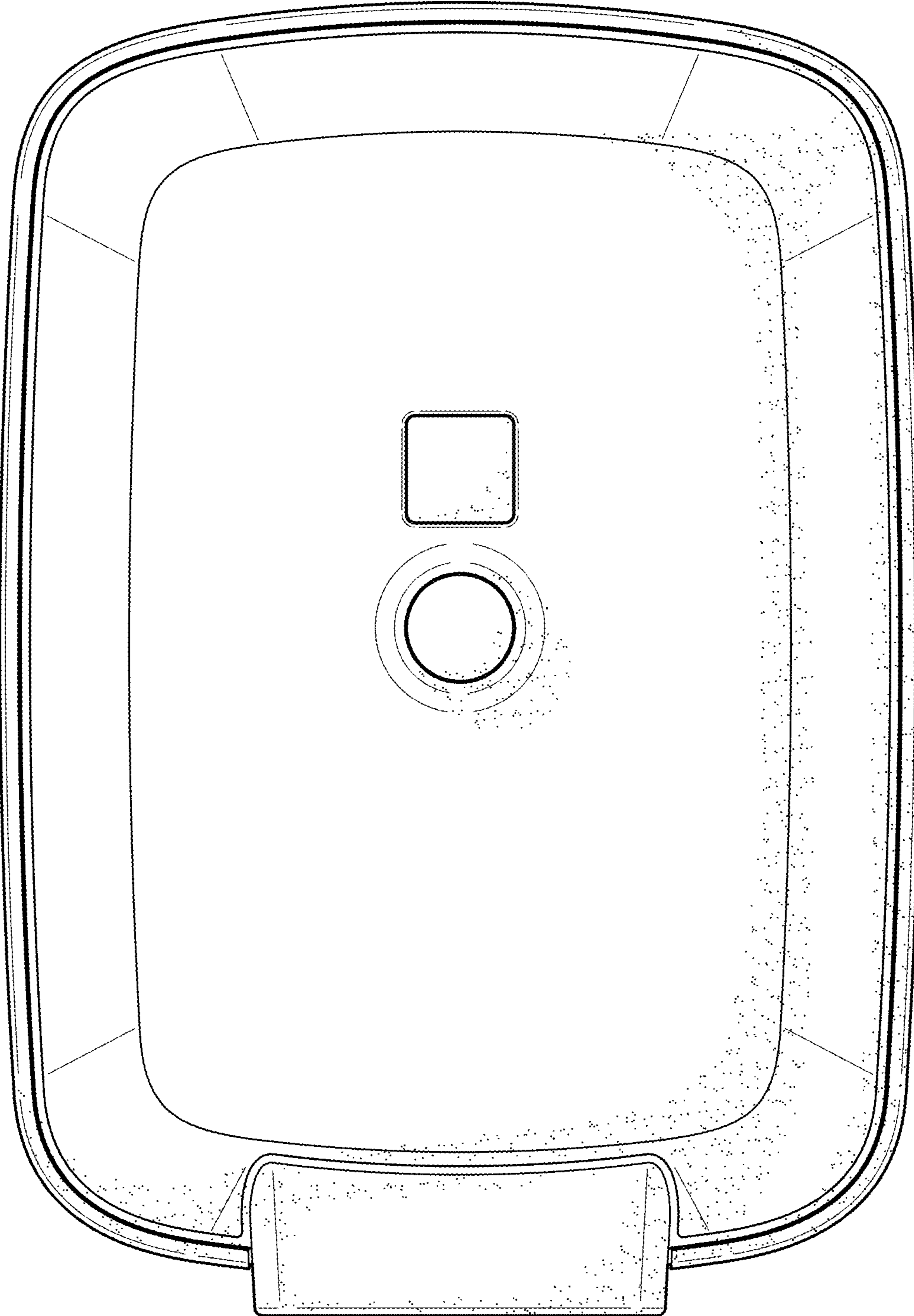

FIG. 3

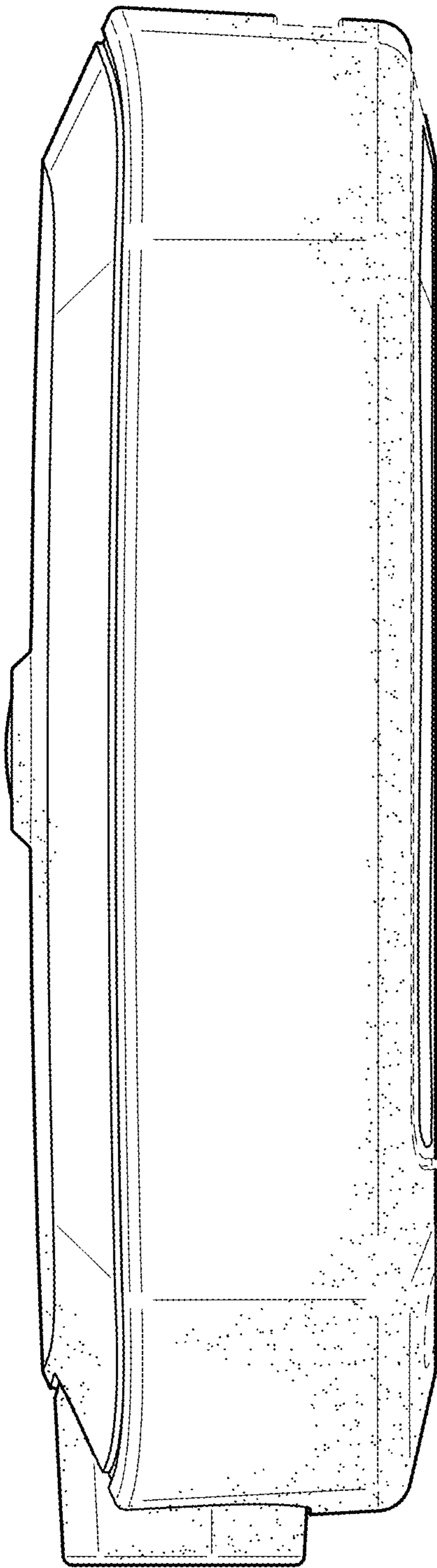

FIG. 4

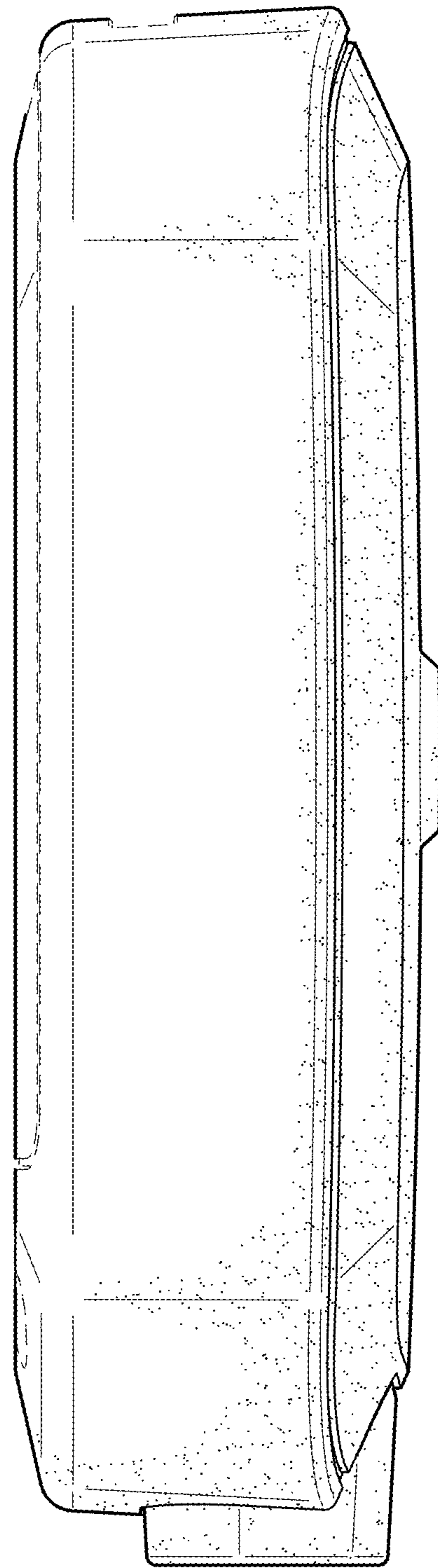

FIG. 5

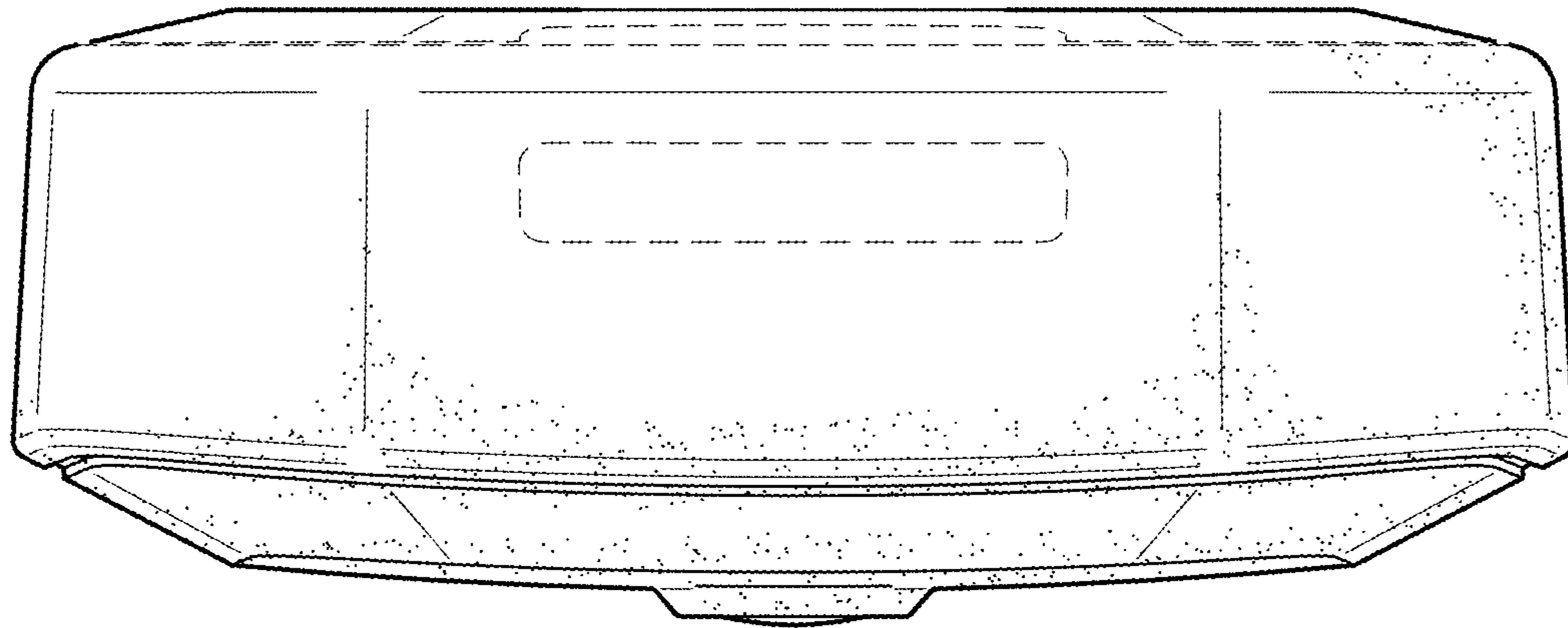

FIG. 6

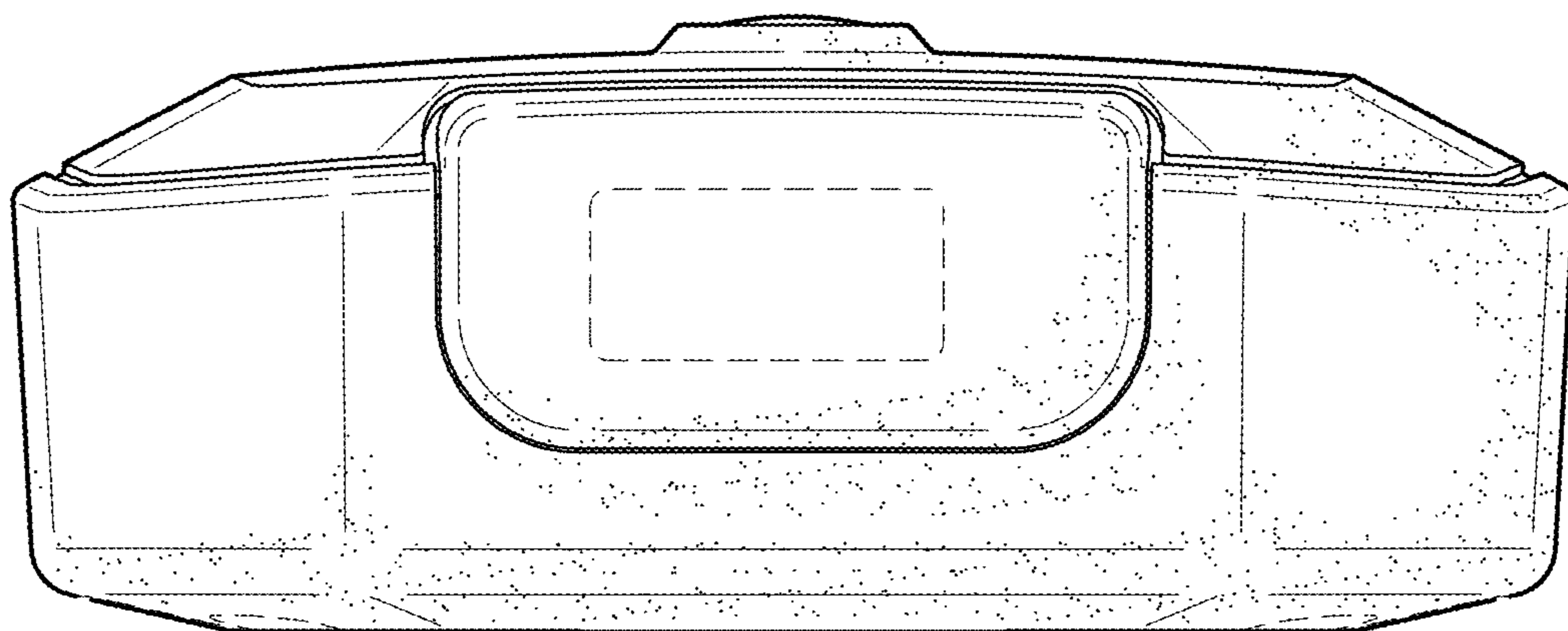

FIG. 7

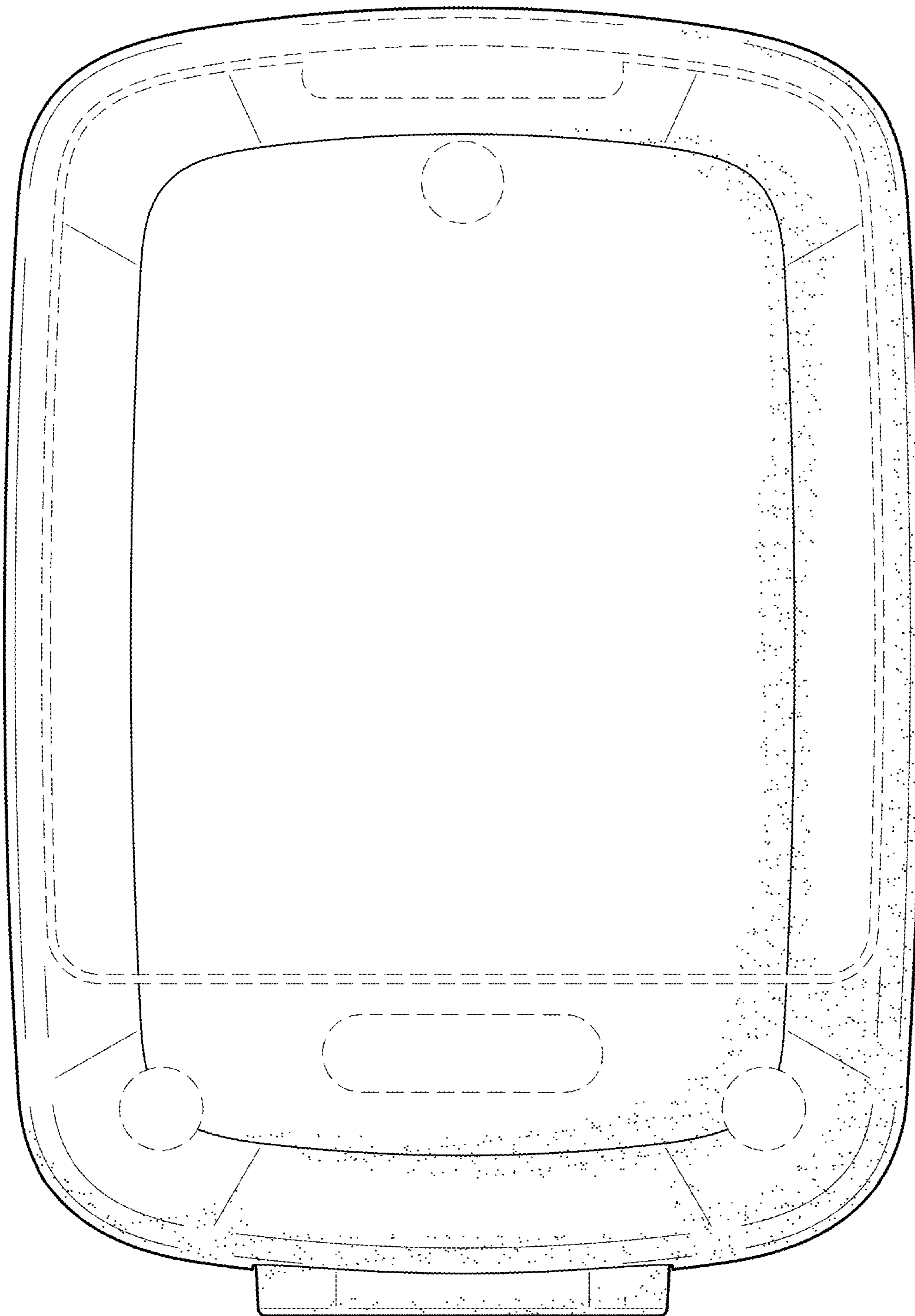

FIG. 8

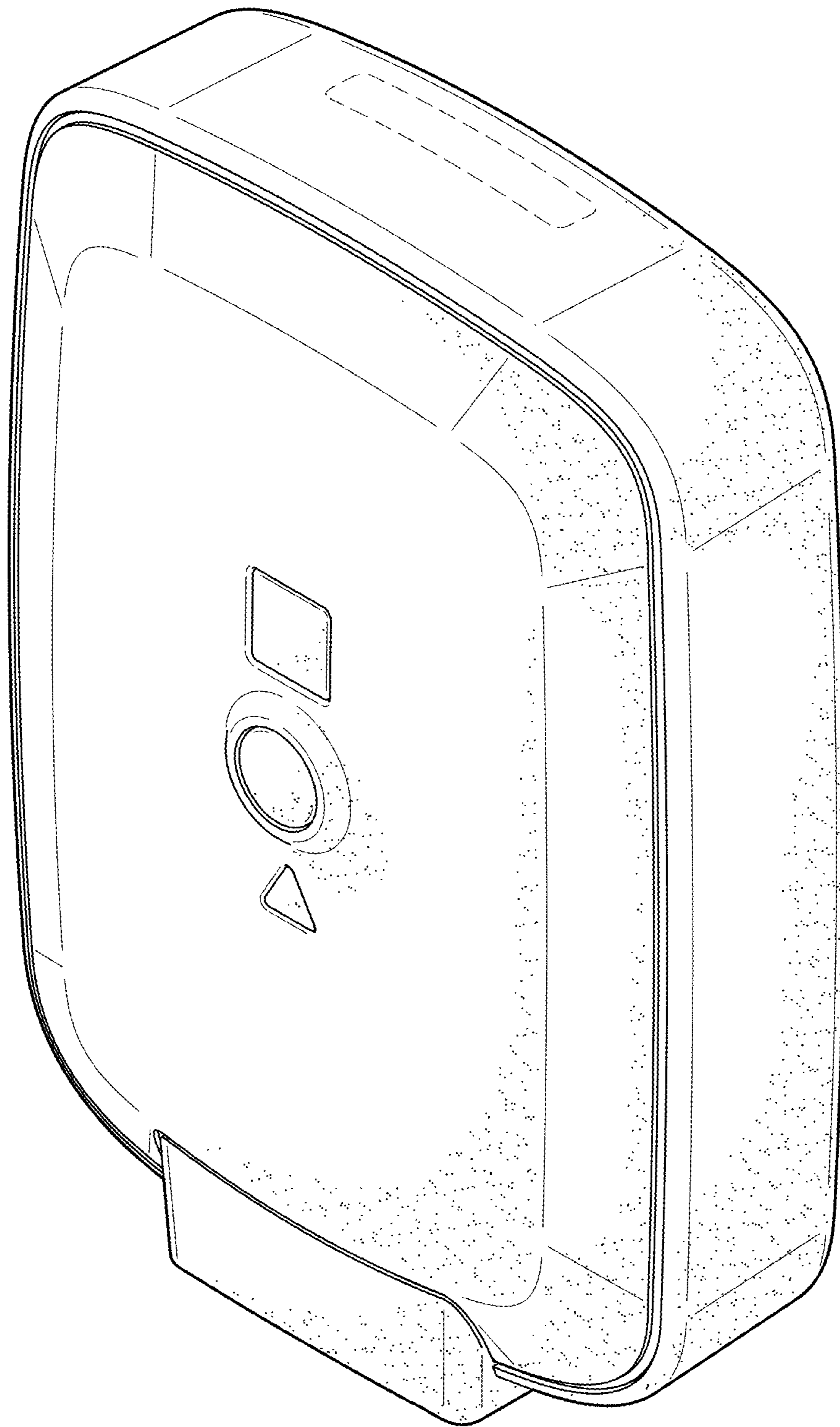

FIG. 9

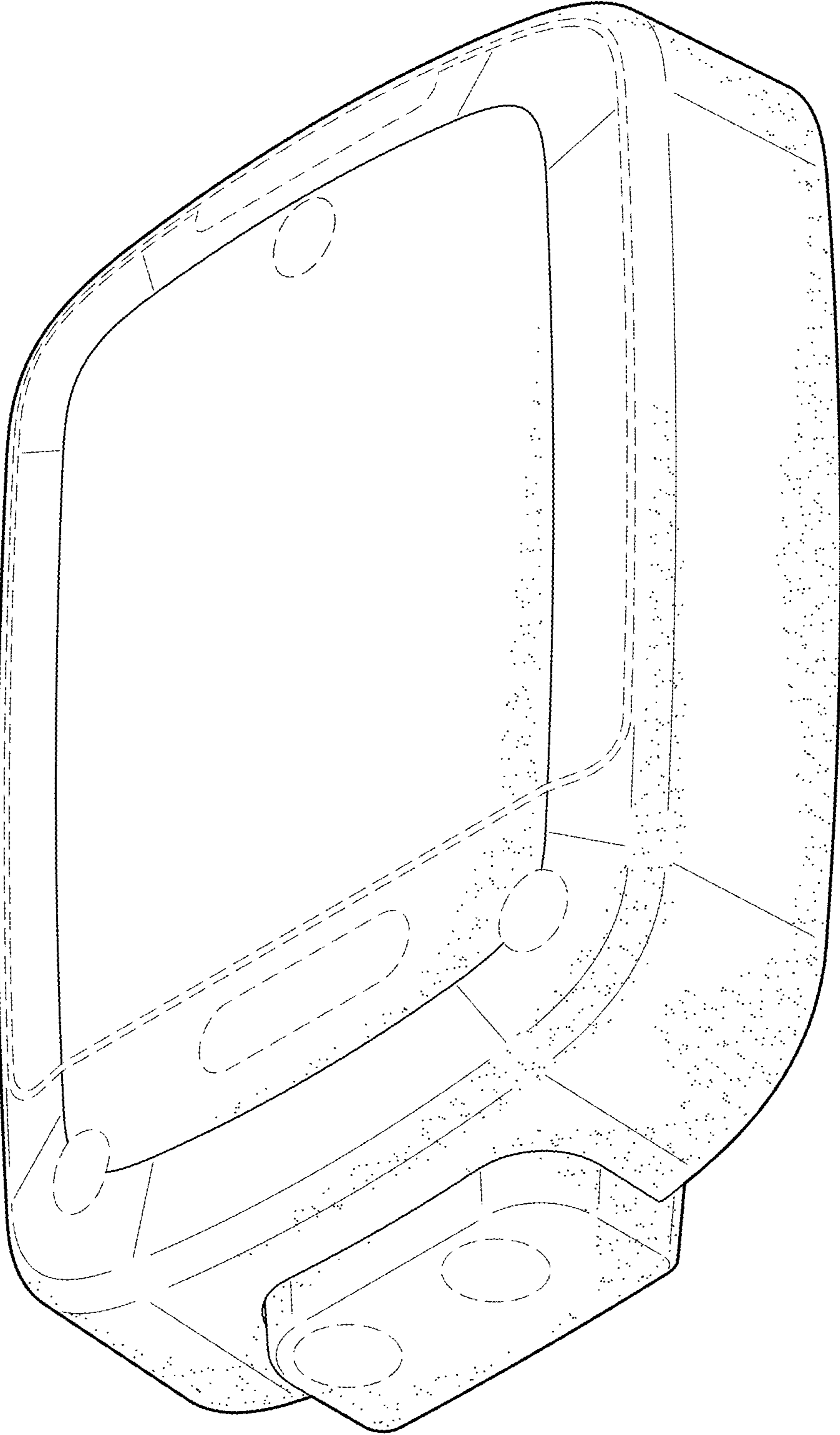

FIG. 10

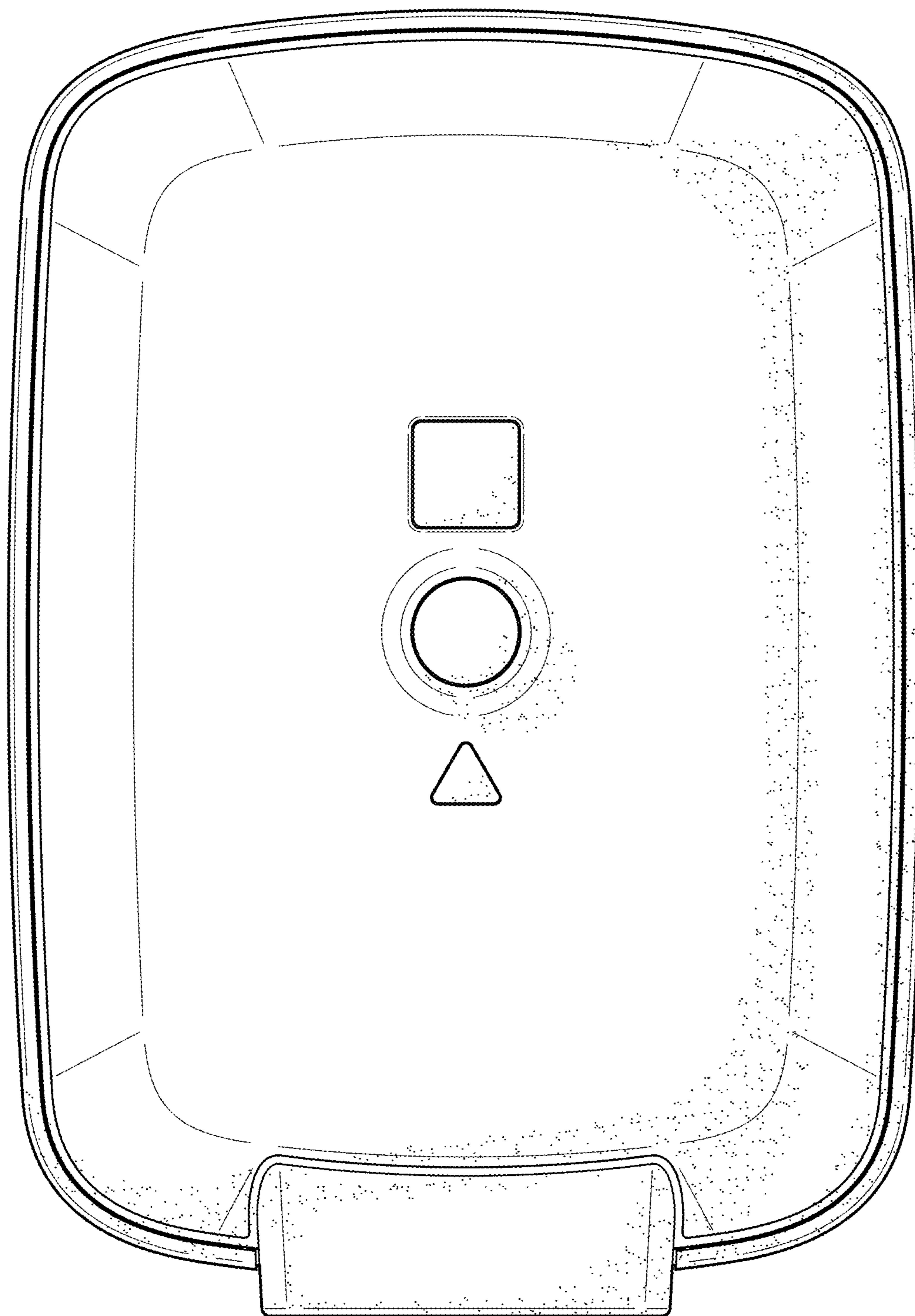

FIG. 11

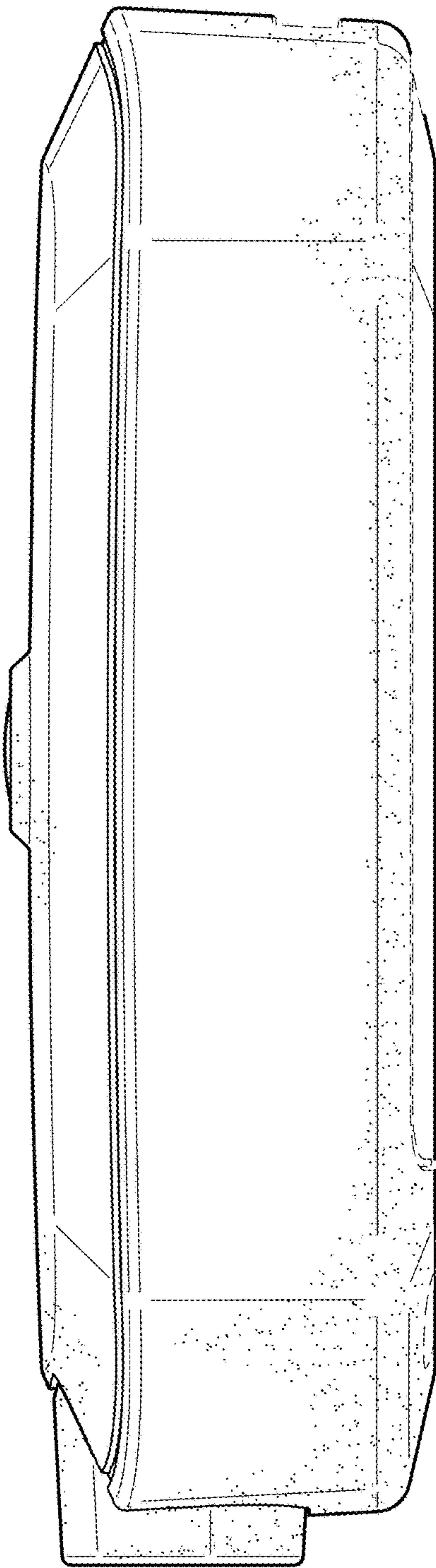

FIG. 12

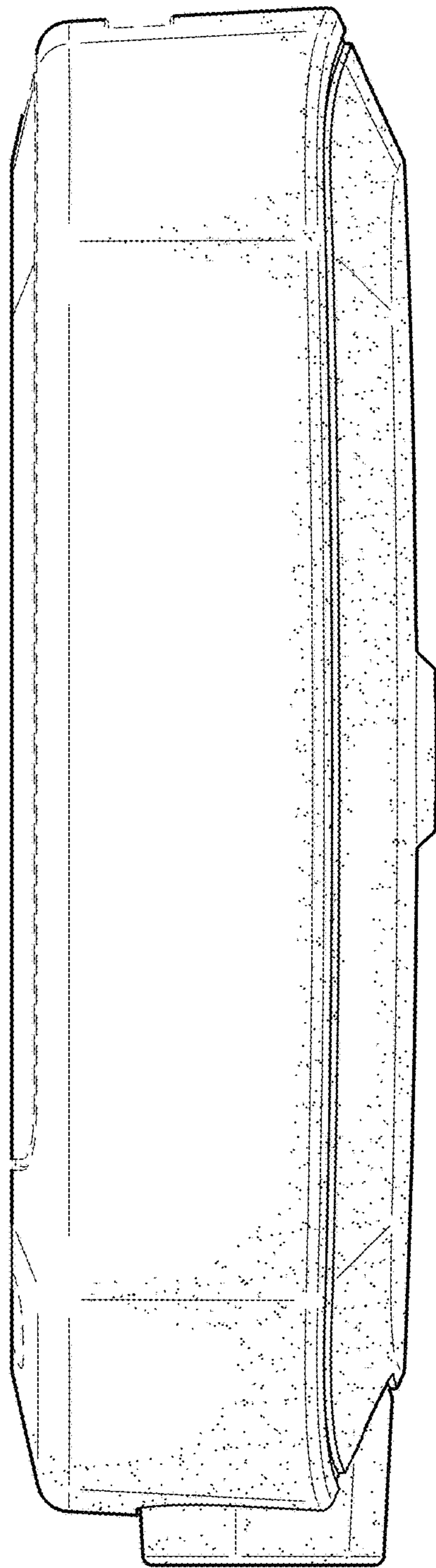

FIG. 13

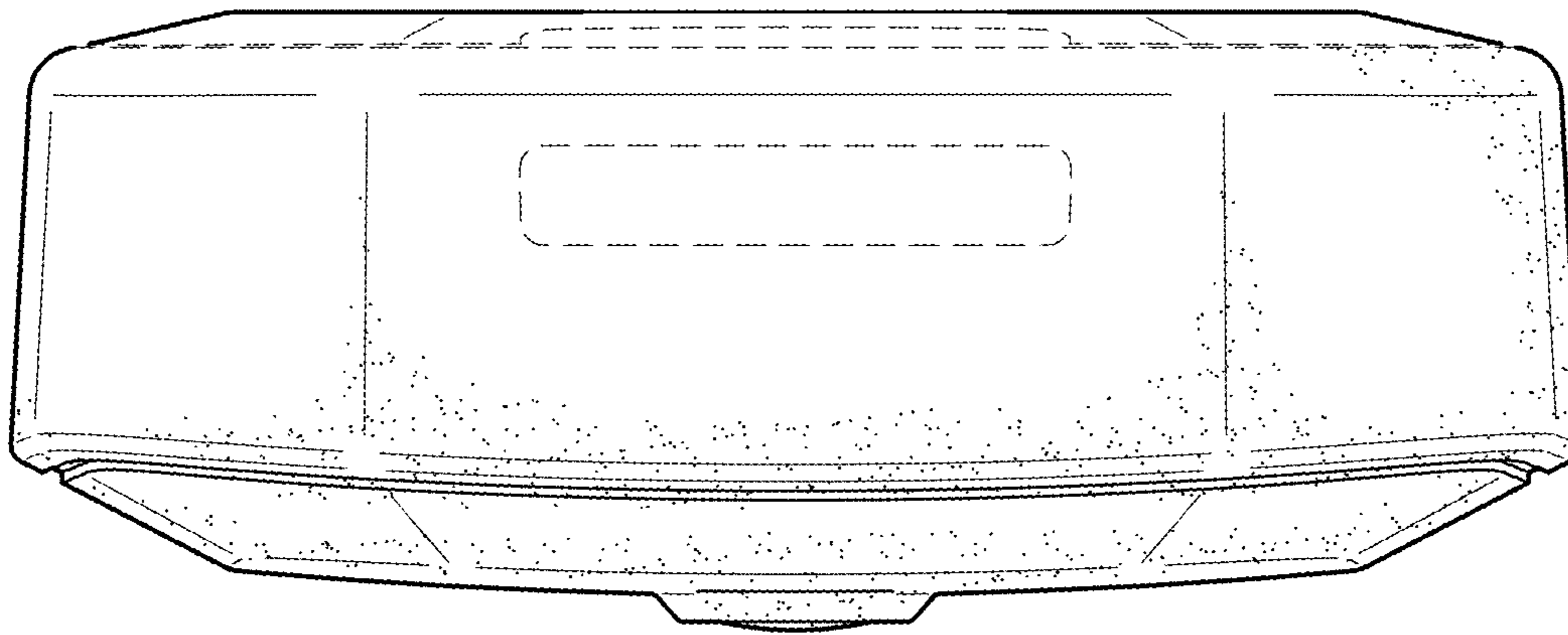

FIG. 14

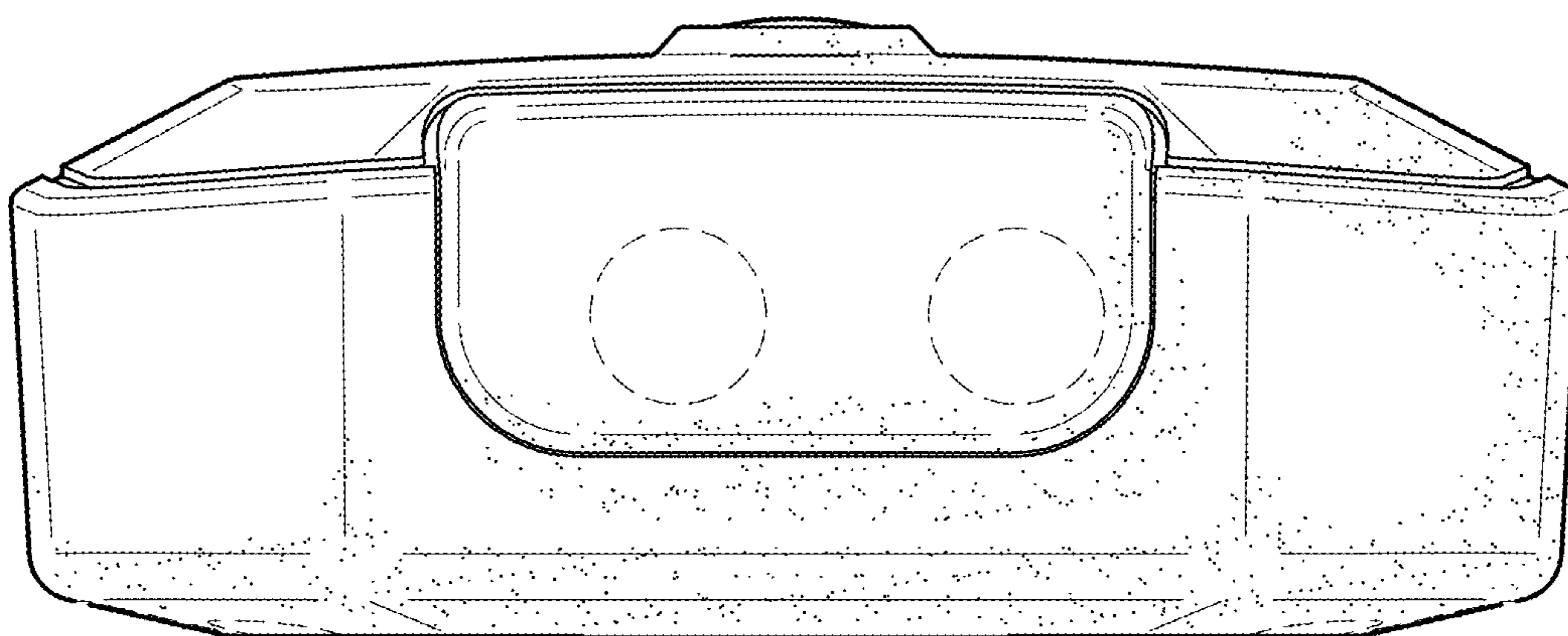

FIG. 15

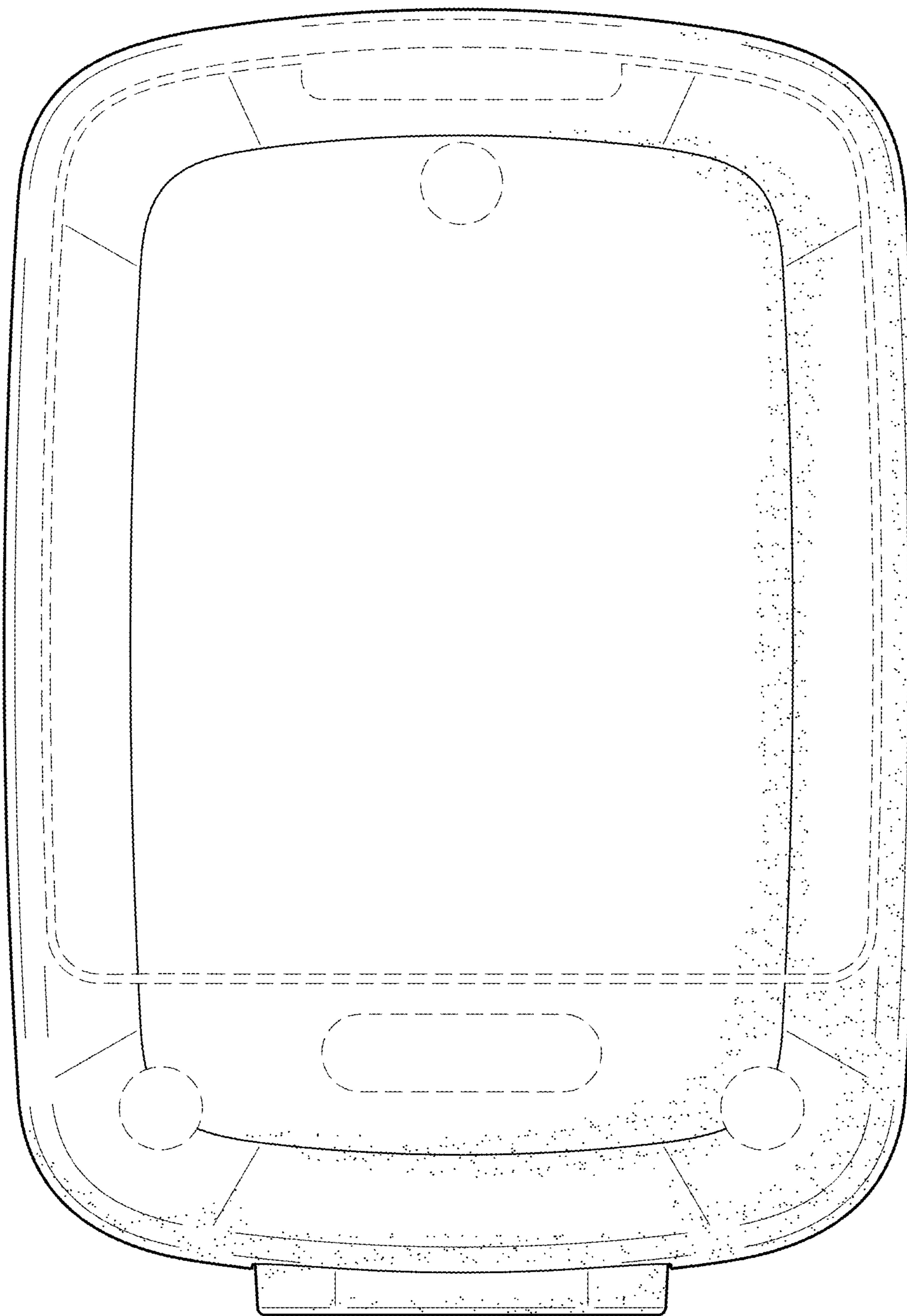

FIG. 16

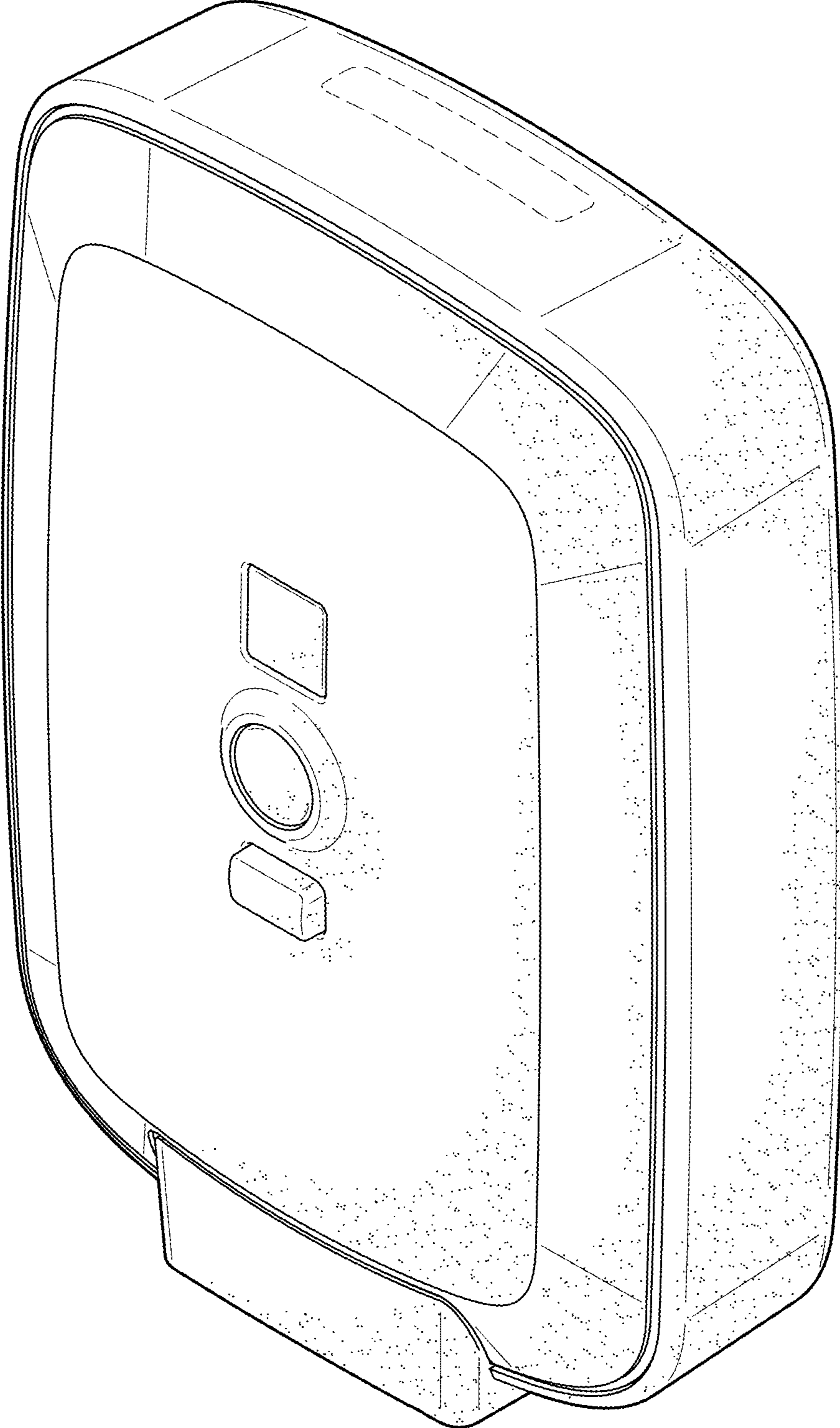

FIG. 17

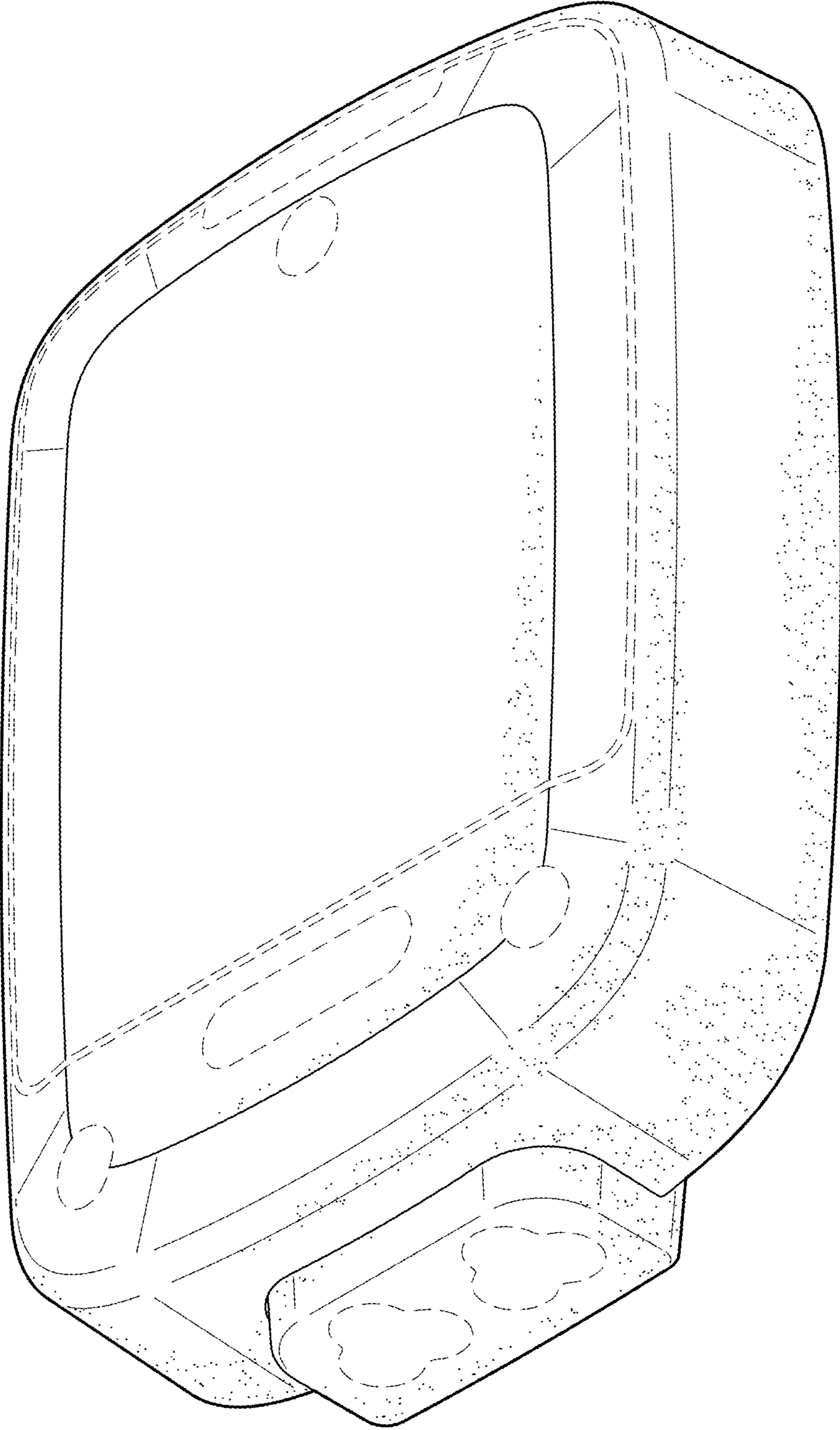

FIG. 18

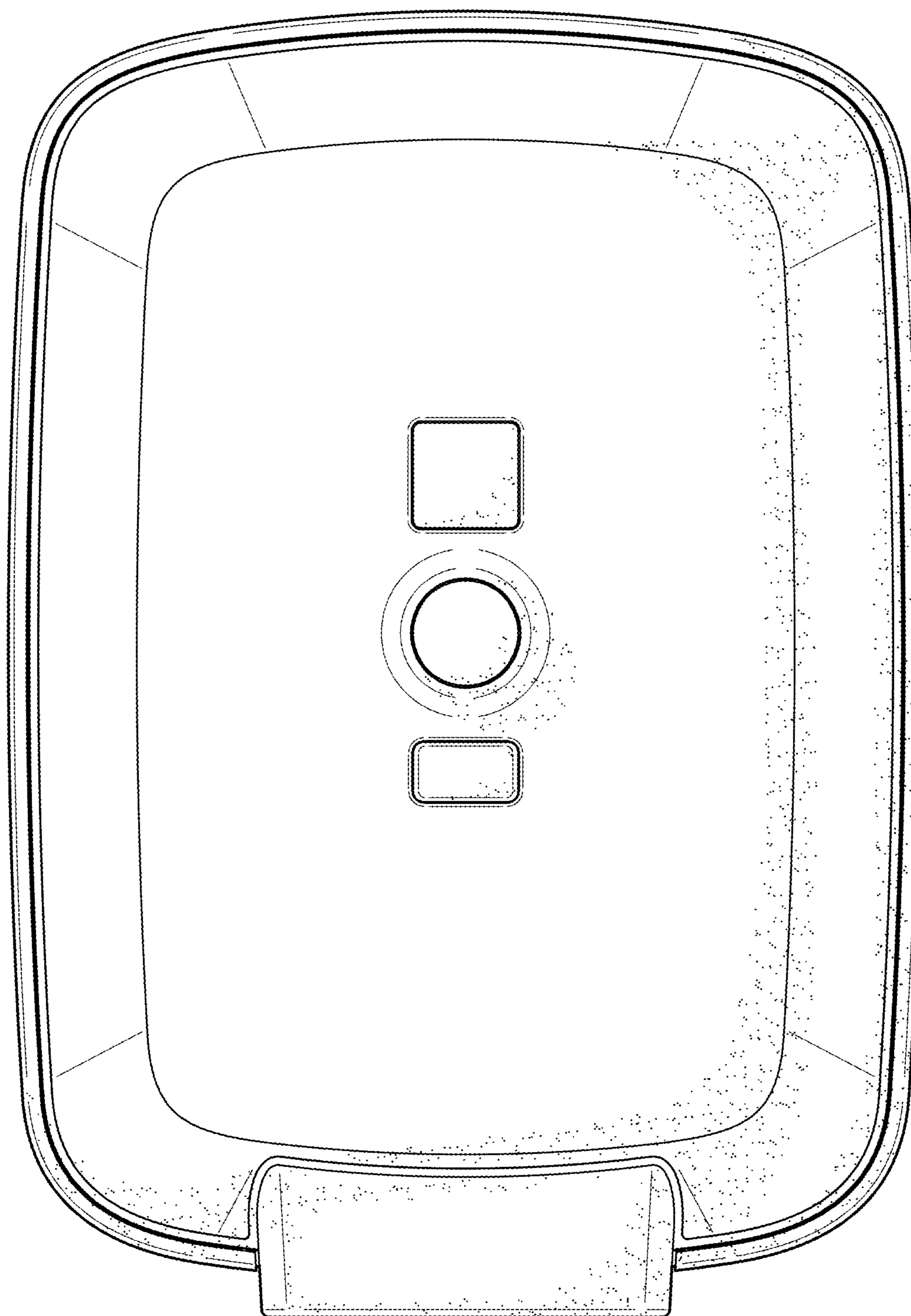

FIG. 19

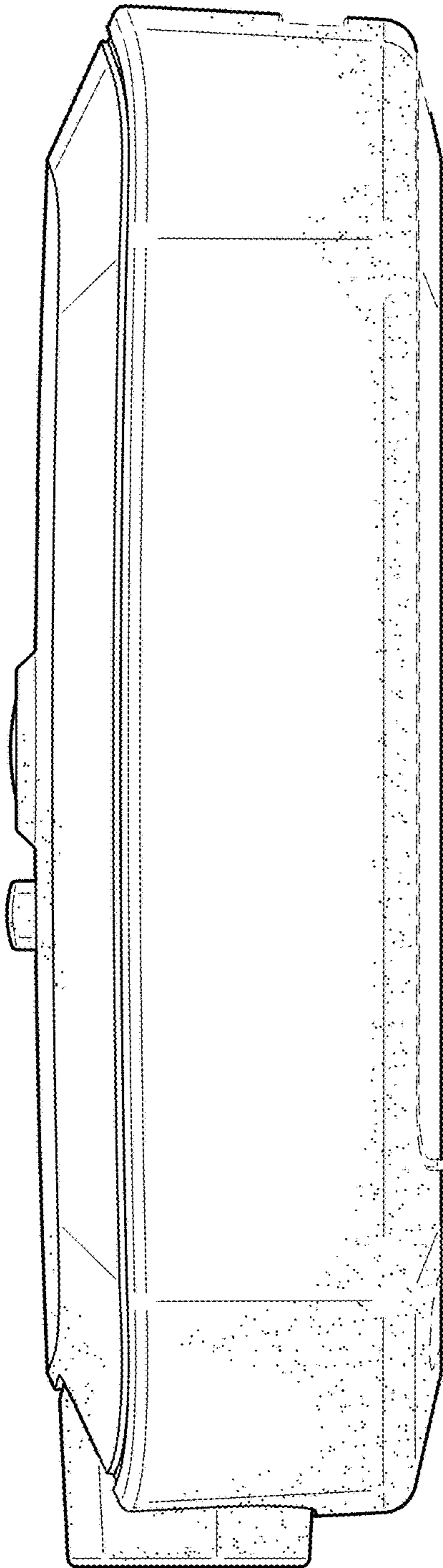

FIG. 20

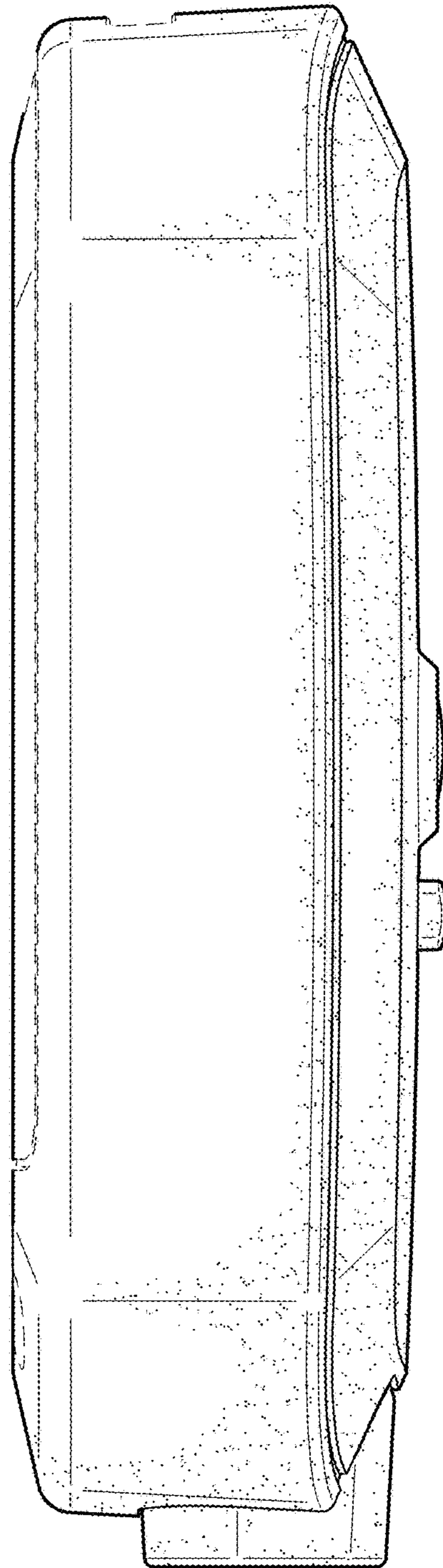

FIG. 21

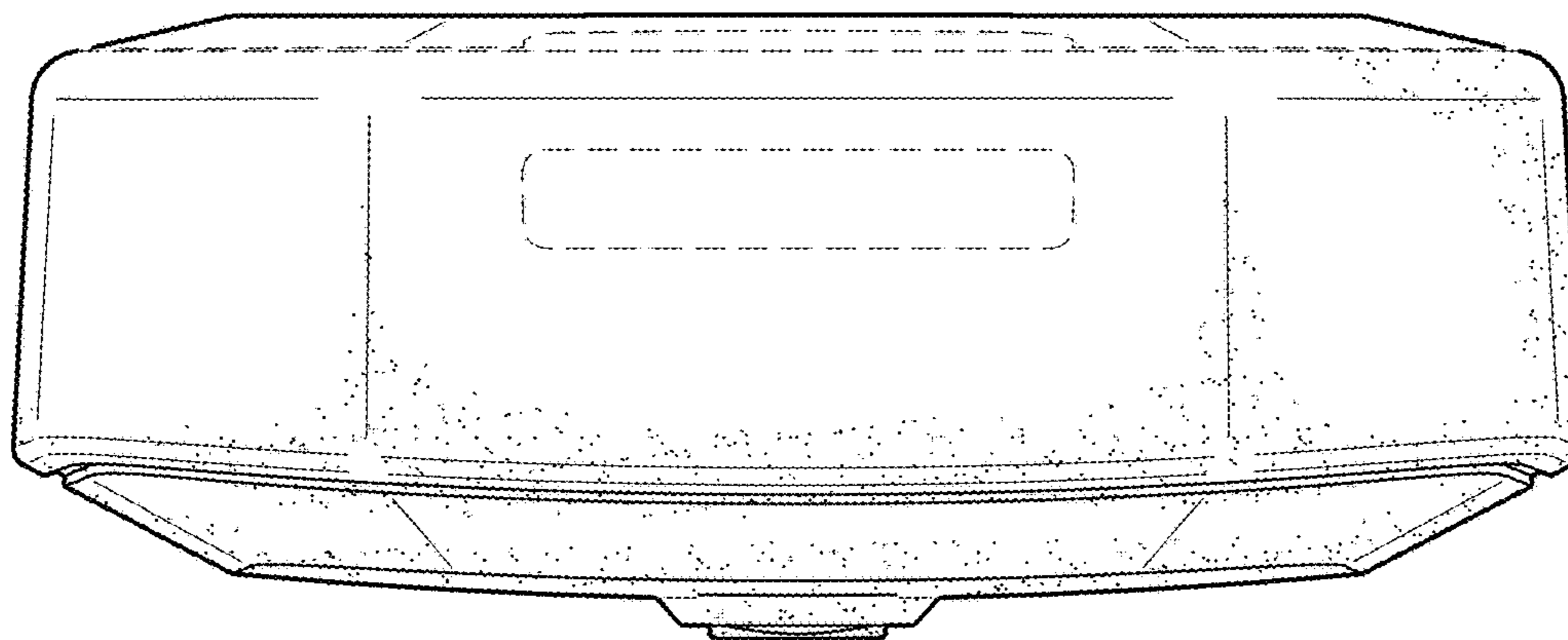

FIG. 22

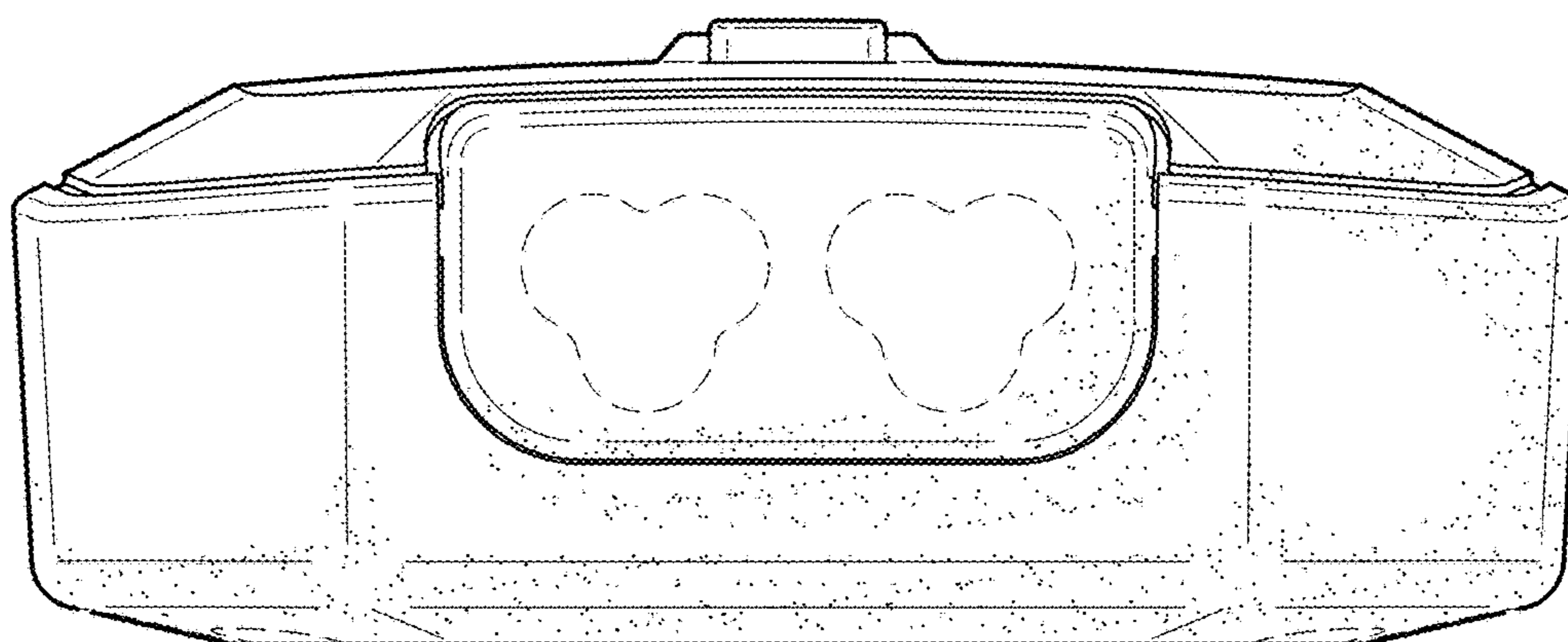

FIG. 23

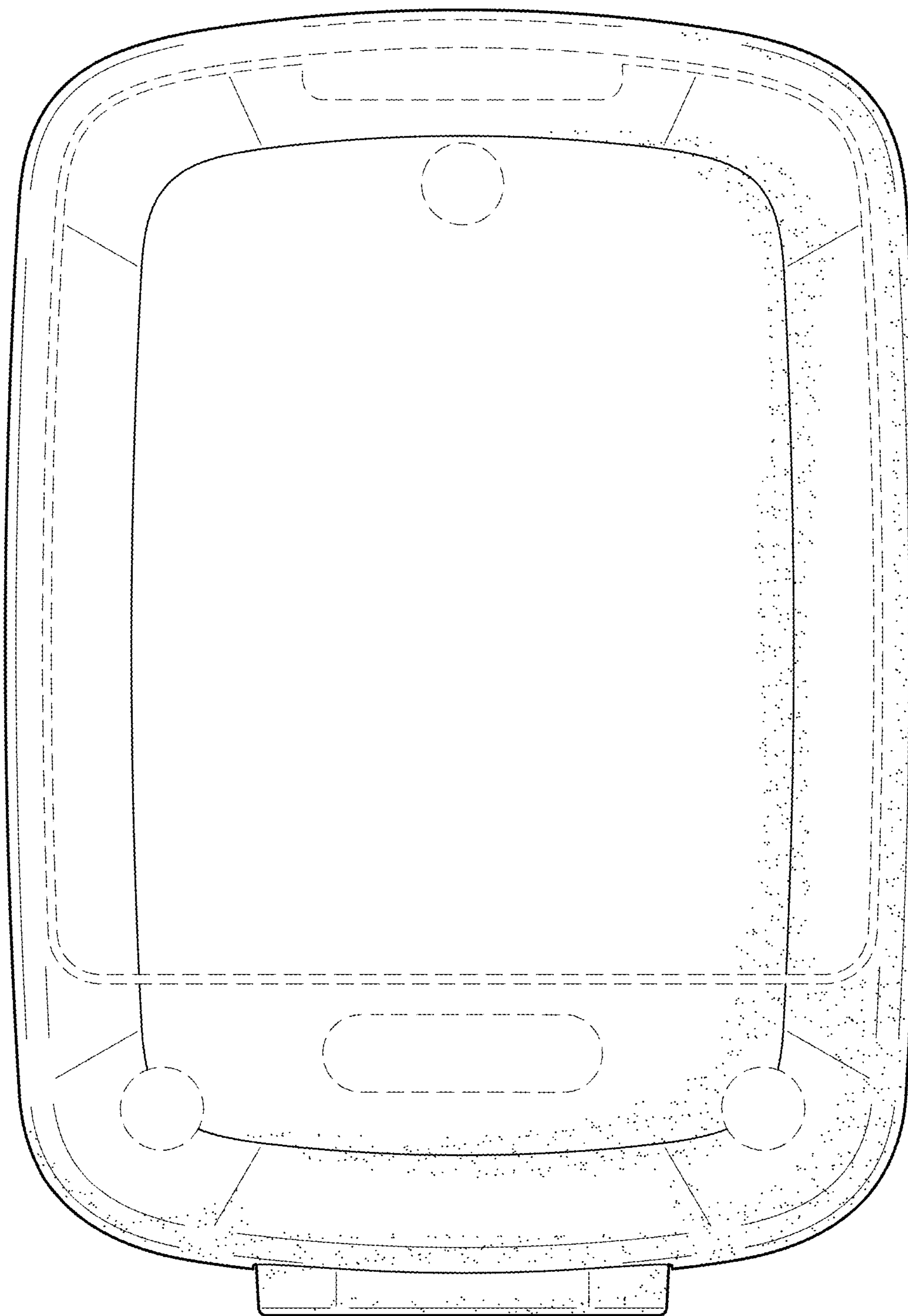

FIG. 24