



US00D816333S

(12) **United States Design Patent**  
**Brunner**

(10) **Patent No.:** **US D816,333 S**

(45) **Date of Patent:** **\*\* May 1, 2018**

(54) **CANTILEVER TOOLBOX**

(71) Applicant: **Keter Plastic Ltd.**, Herzelyia (IL)

(72) Inventor: **Yaron Brunner**, Kibbutz Gvat (IL)

(73) Assignee: **KETER PLASTIC LTD.**, Herzelyia (IL)

(\*\*) Term: **15 Years**

(21) Appl. No.: **29/582,340**

(22) Filed: **Oct. 27, 2016**

(51) **LOC (11) Cl.** ..... **03-01**

(52) **U.S. Cl.**  
USPC ..... **D3/273**

(58) **Field of Classification Search**  
USPC ..... D3/273, 285, 294  
CPC ..... A45C 5/00; A45C 5/14; A45C 13/26  
See application file for complete search history.

(56) **References Cited**

U.S. PATENT DOCUMENTS

D419,767 S	*	2/2000	Richardson	.....	D3/273
D668,865 S	*	10/2012	Gregerson	.....	D3/273
D701,044 S	*	3/2014	Kishimoto	.....	D3/272
D724,320 S	*	3/2015	Russell	.....	D3/273

\* cited by examiner

*Primary Examiner* — Holly H Baynham

(74) *Attorney, Agent, or Firm* — Vorys, Sater, Seymour & Pease LLP

(57) **CLAIM**

The ornamental design for a cantilever toolbox, as shown and described.

**DESCRIPTION**

FIG. 1 is a perspective view of a design for a cantilever toolbox;  
 FIG. 2 is a front elevational view of the design as seen in FIG. 1;  
 FIG. 3 is a rear elevational view of the design as seen in FIG. 1;  
 FIG. 4 is a left side elevational view of the design as seen in FIG. 1;  
 FIG. 5 is a right side elevational view of the design as seen in FIG. 1;  
 FIG. 6 is a top plan view of the design as seen in FIG. 1; and  
 FIG. 7 is a bottom plan view of the design as seen in FIG. 1;  
 FIG. 8 is a perspective view of a design for a cantilever toolbox;  
 FIG. 9 is a front elevational view of the design as seen in FIG. 8;  
 FIG. 10 is a rear elevational view of the design as seen in FIG. 8;  
 FIG. 11 is a left side elevational view of the design as seen in FIG. 8;  
 FIG. 12 is a right side elevational view of the design as seen in FIG. 8;  
 FIG. 13 is a top plan view of the design as seen in FIG. 8; and  
 FIG. 14 is a bottom plan view of the design as seen in FIG. 8.

The broken lines showing portions of the toolbox are for the purposes of illustrating environment and form no part of the claimed design.

**1 Claim, 14 Drawing Sheets**

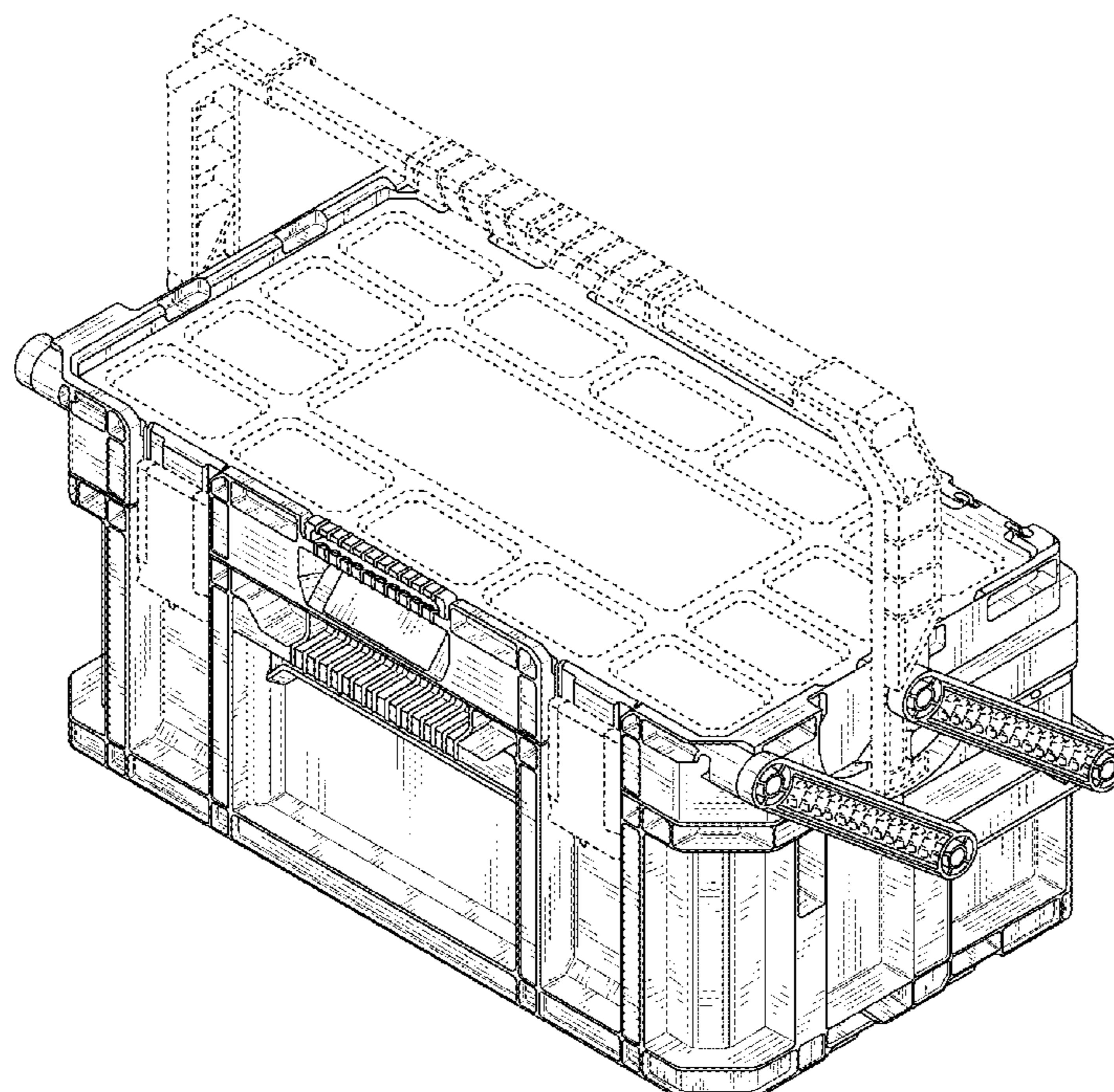

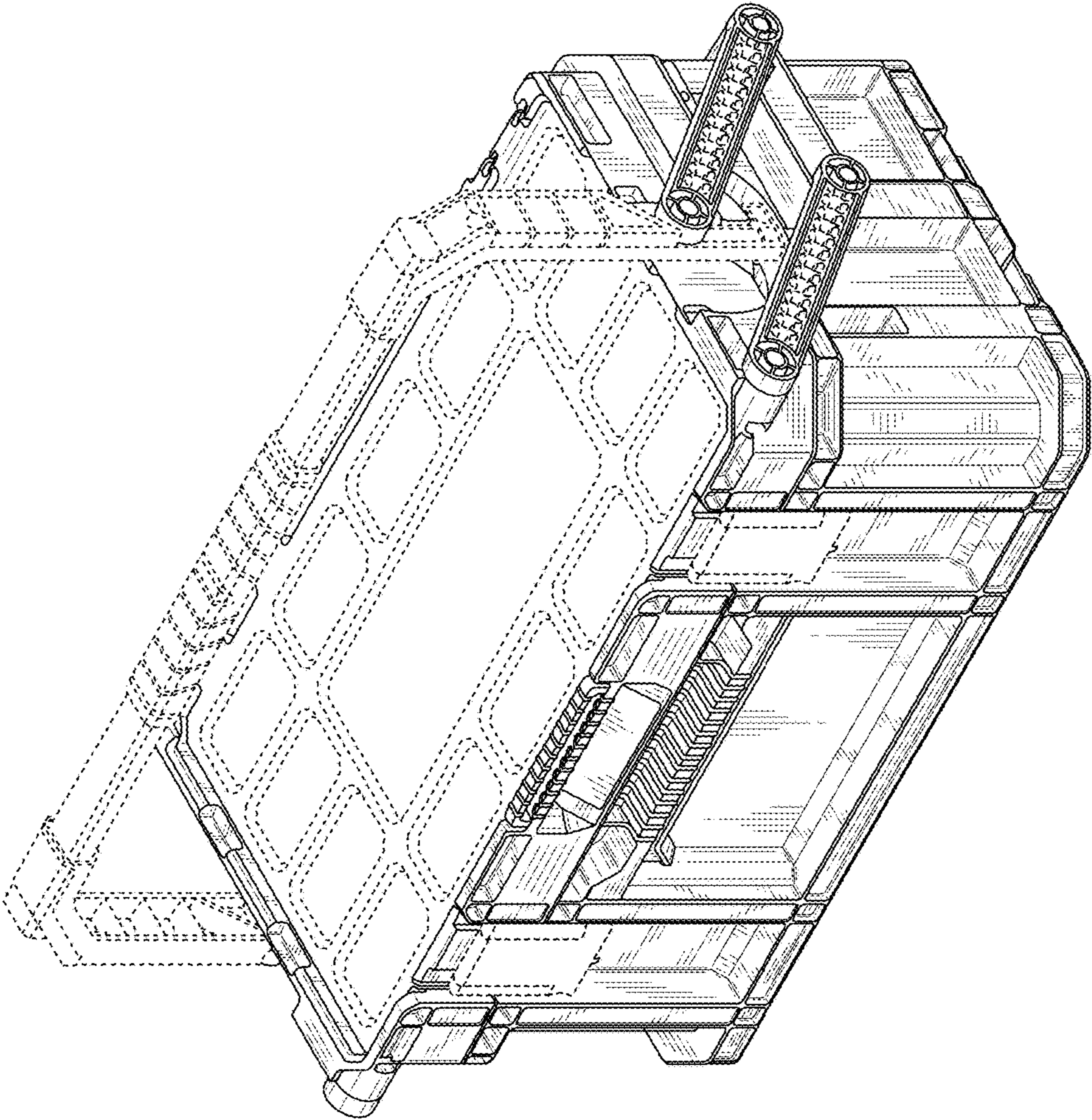

FIG. 1

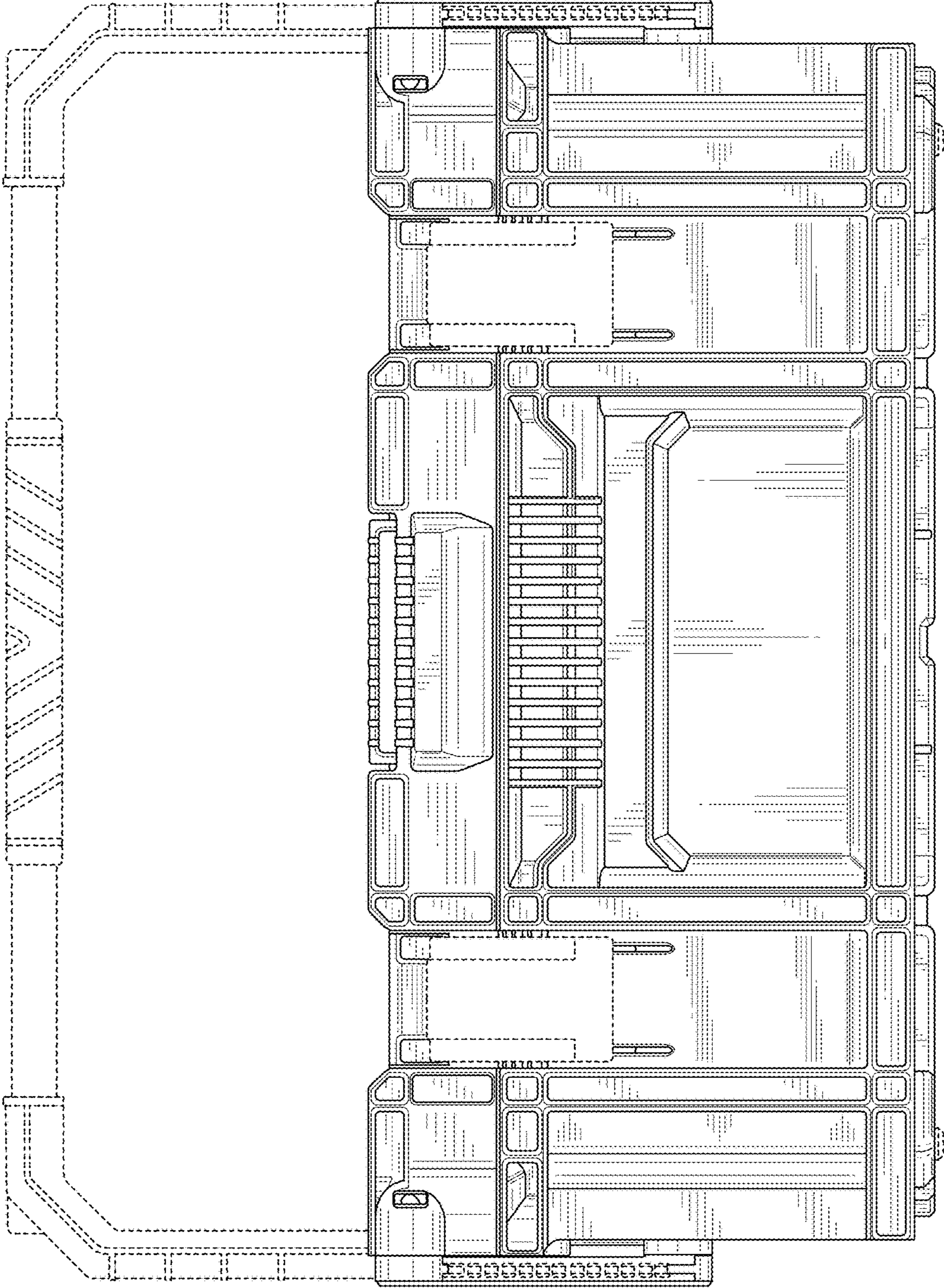

FIG. 2

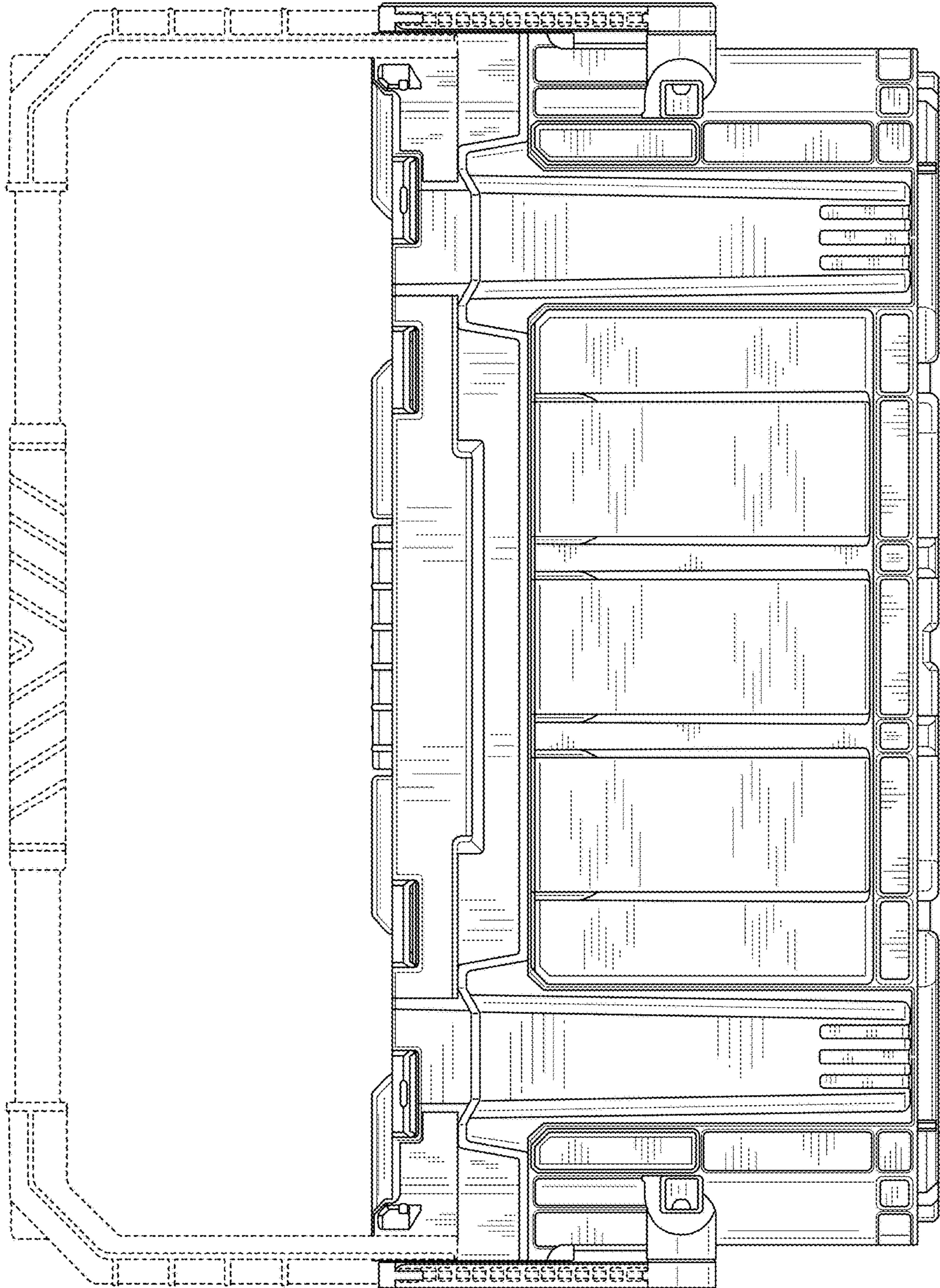

FIG. 3

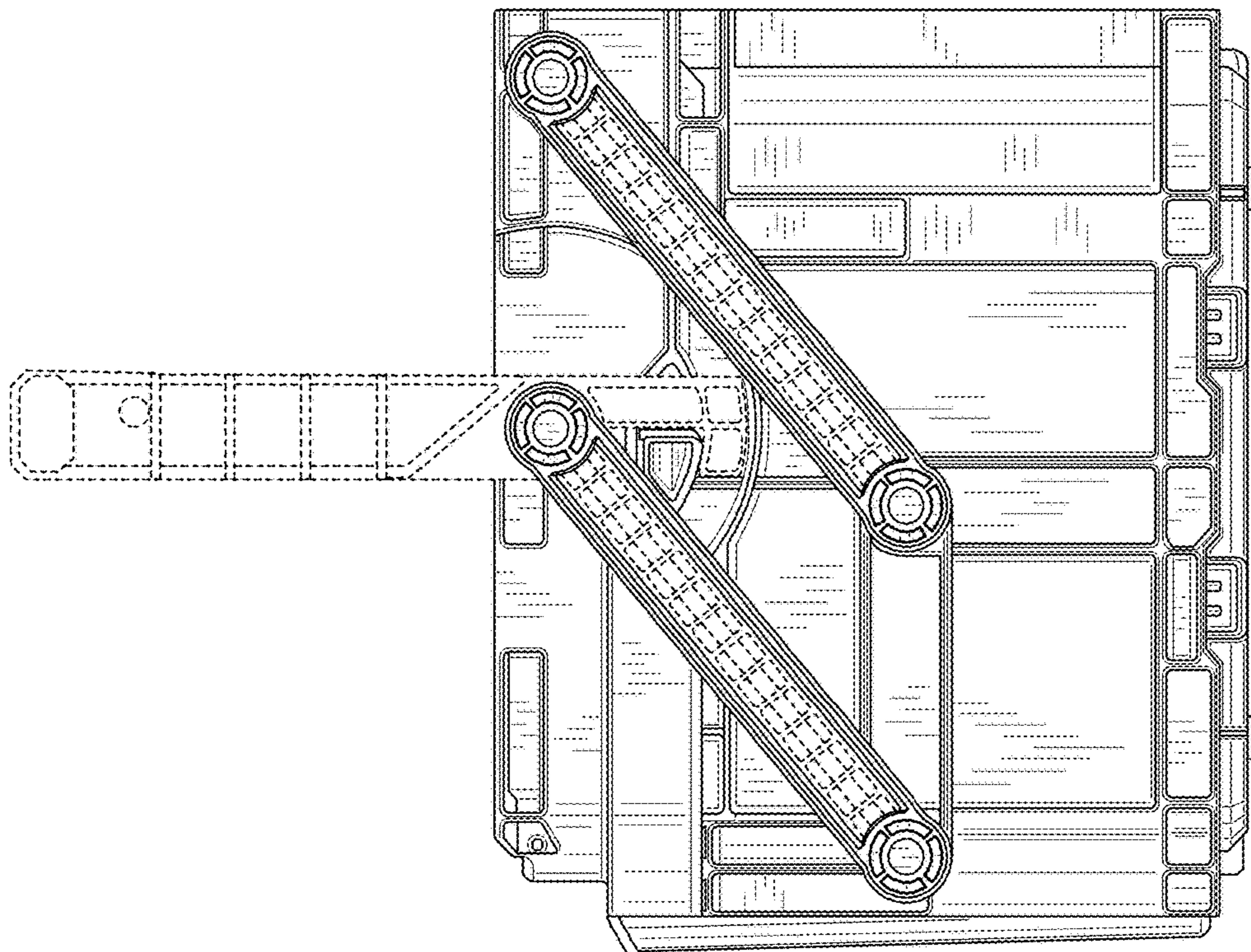

FIG. 4

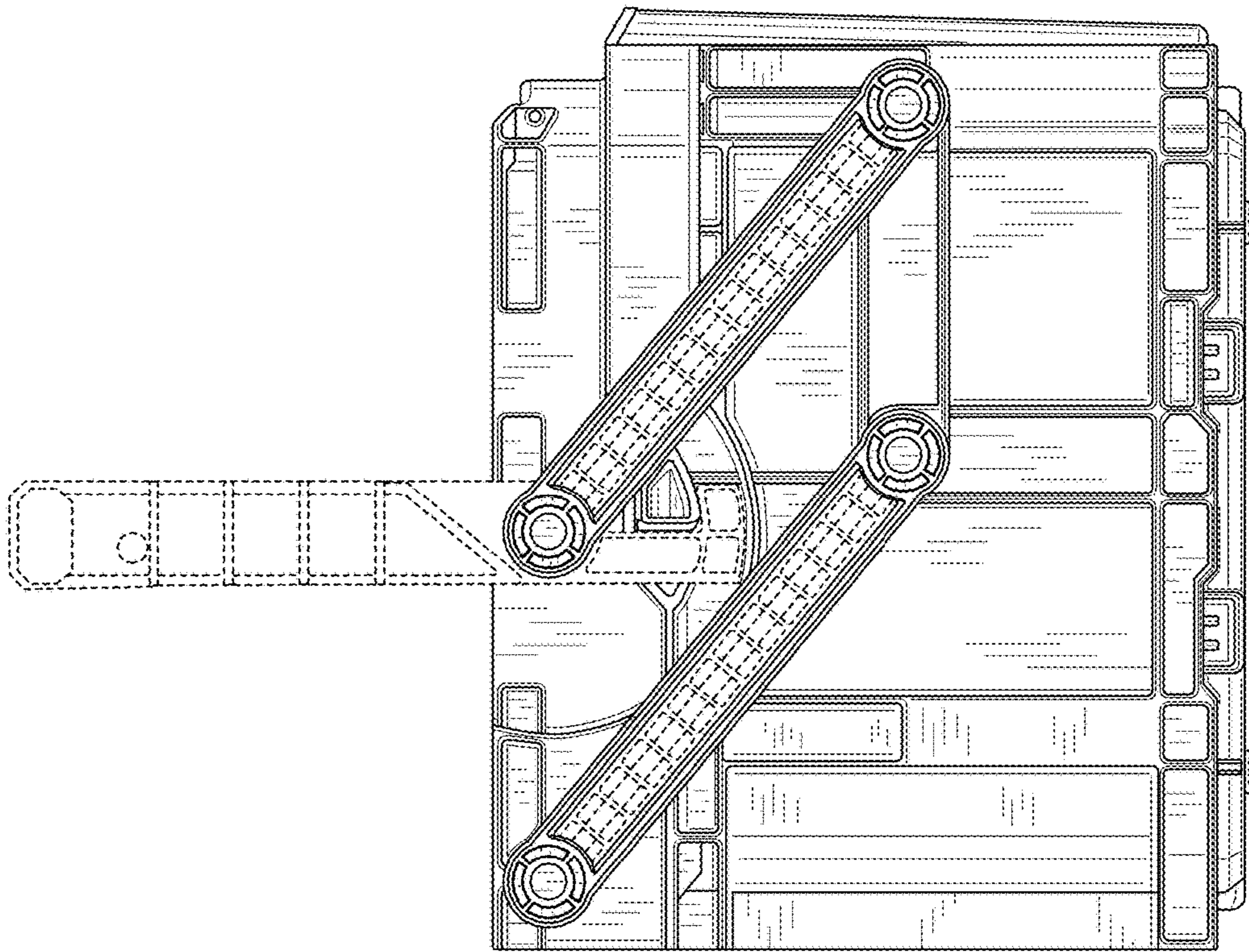

FIG. 5

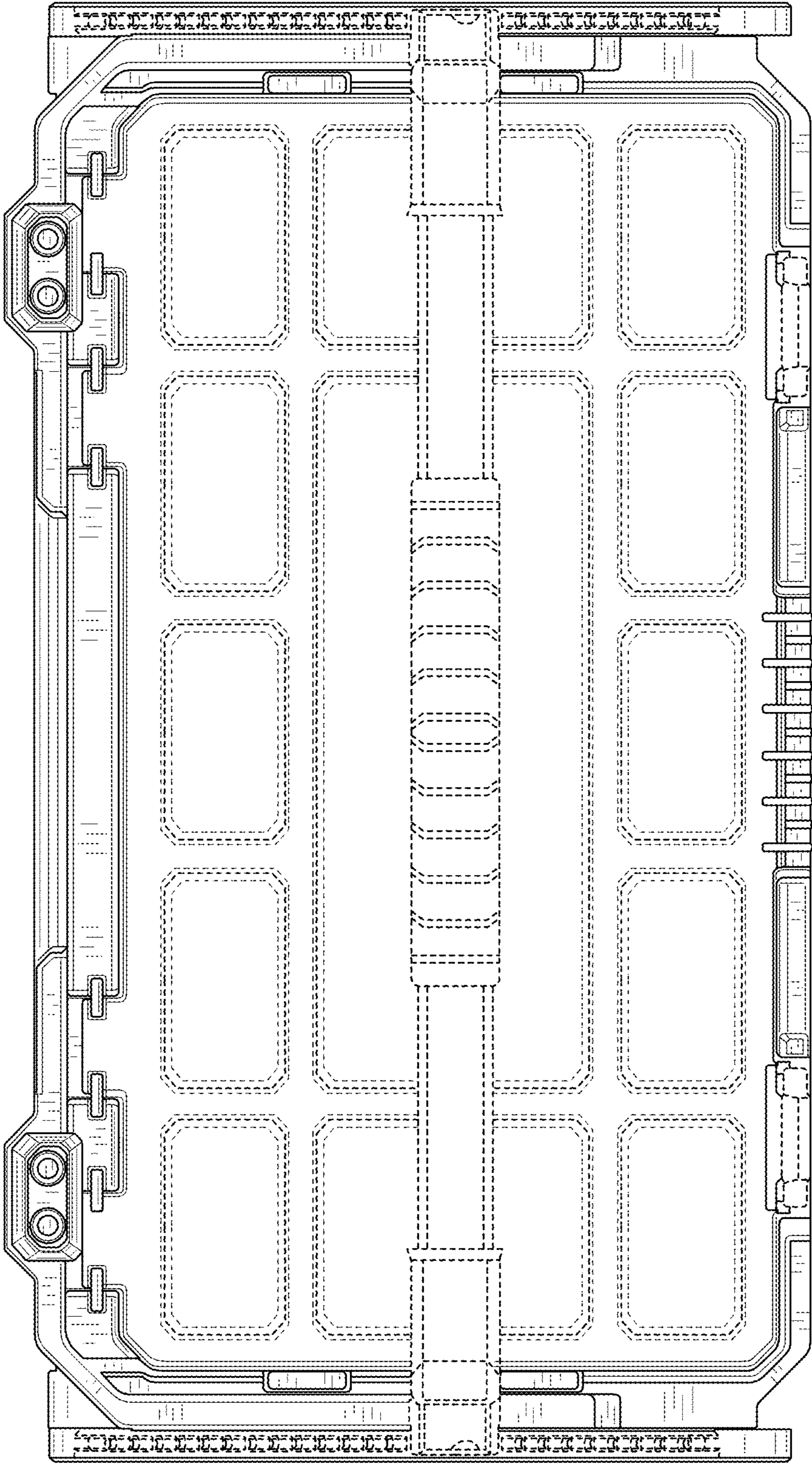

FIG. 6

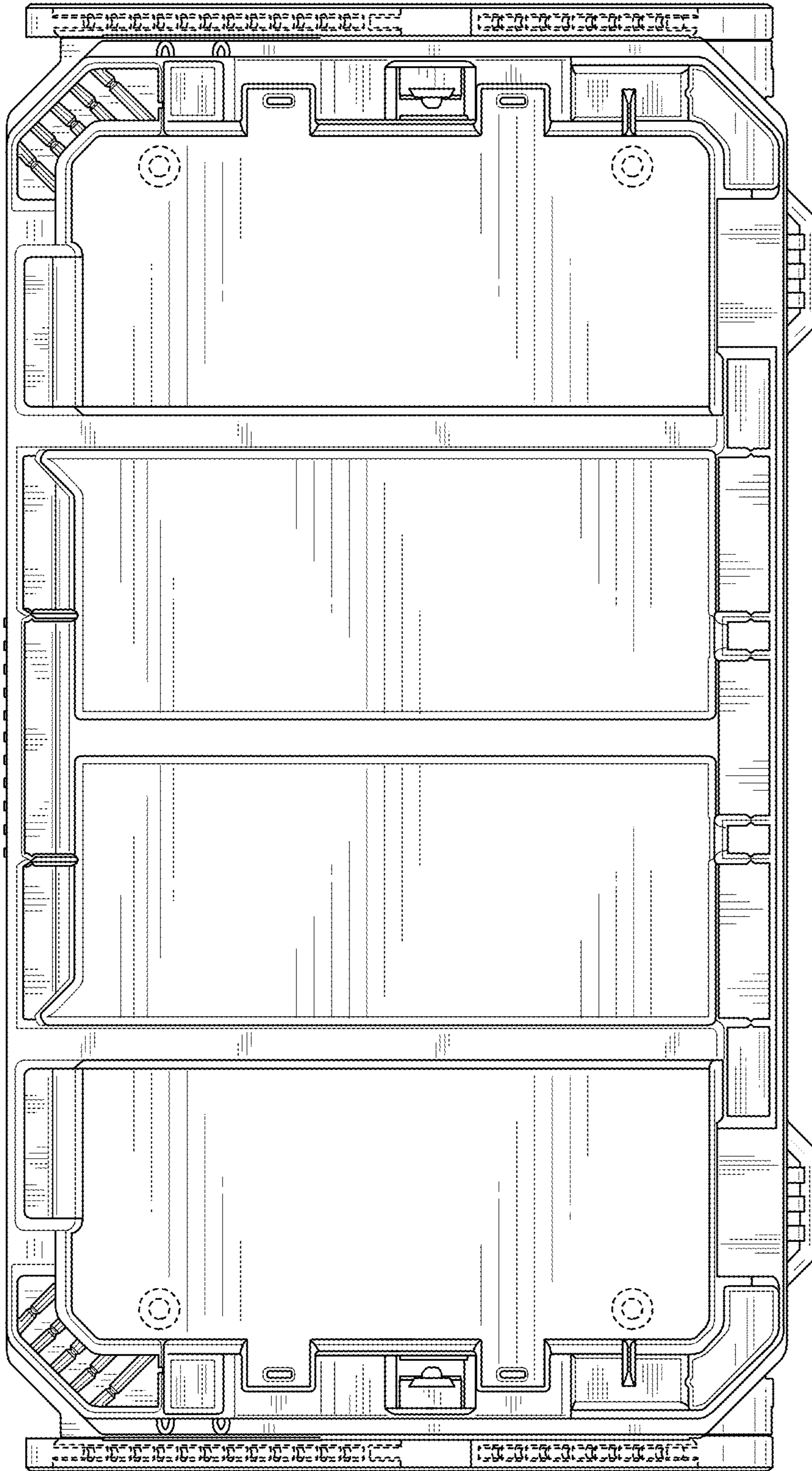

FIG. 7



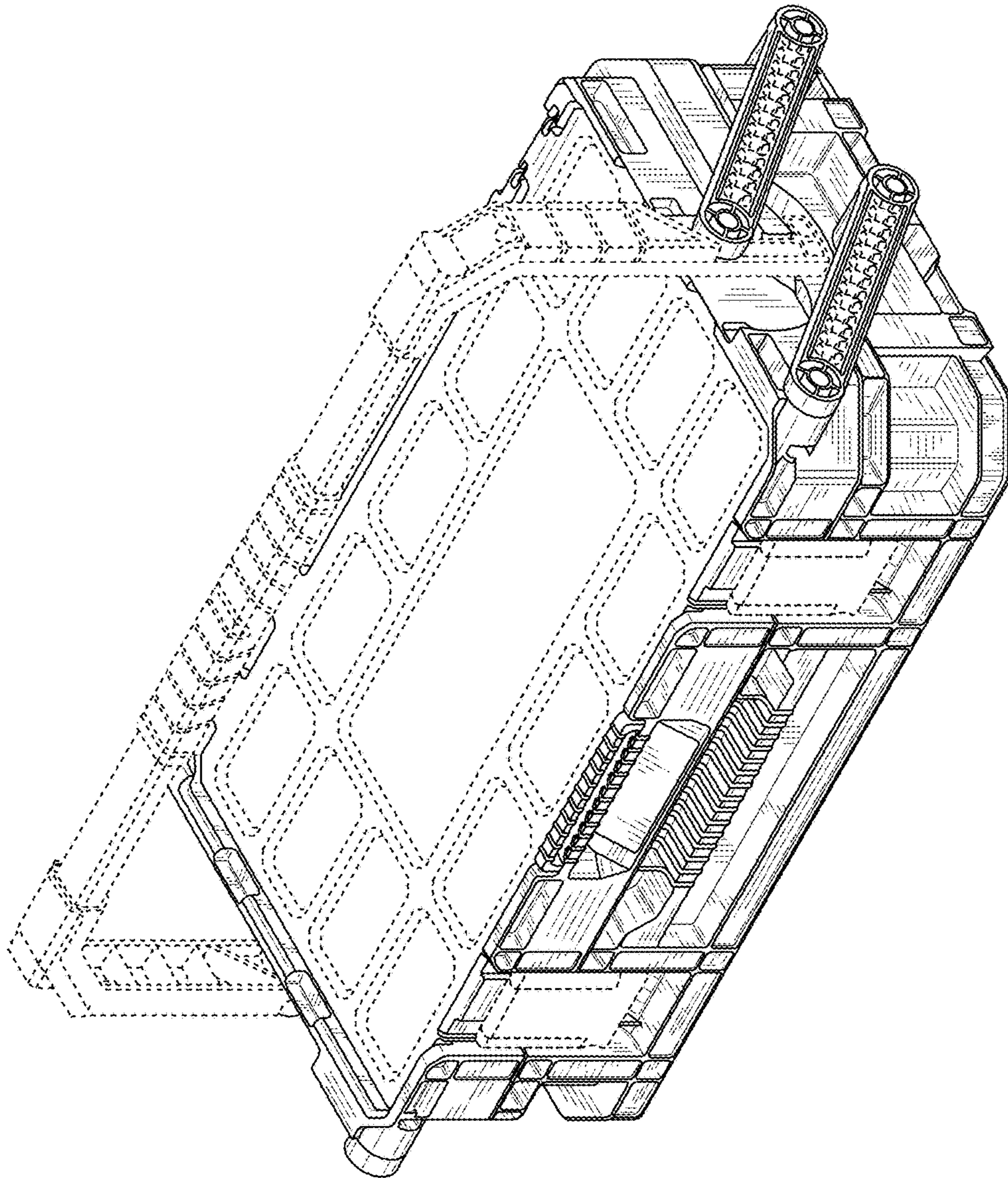

FIG. 8

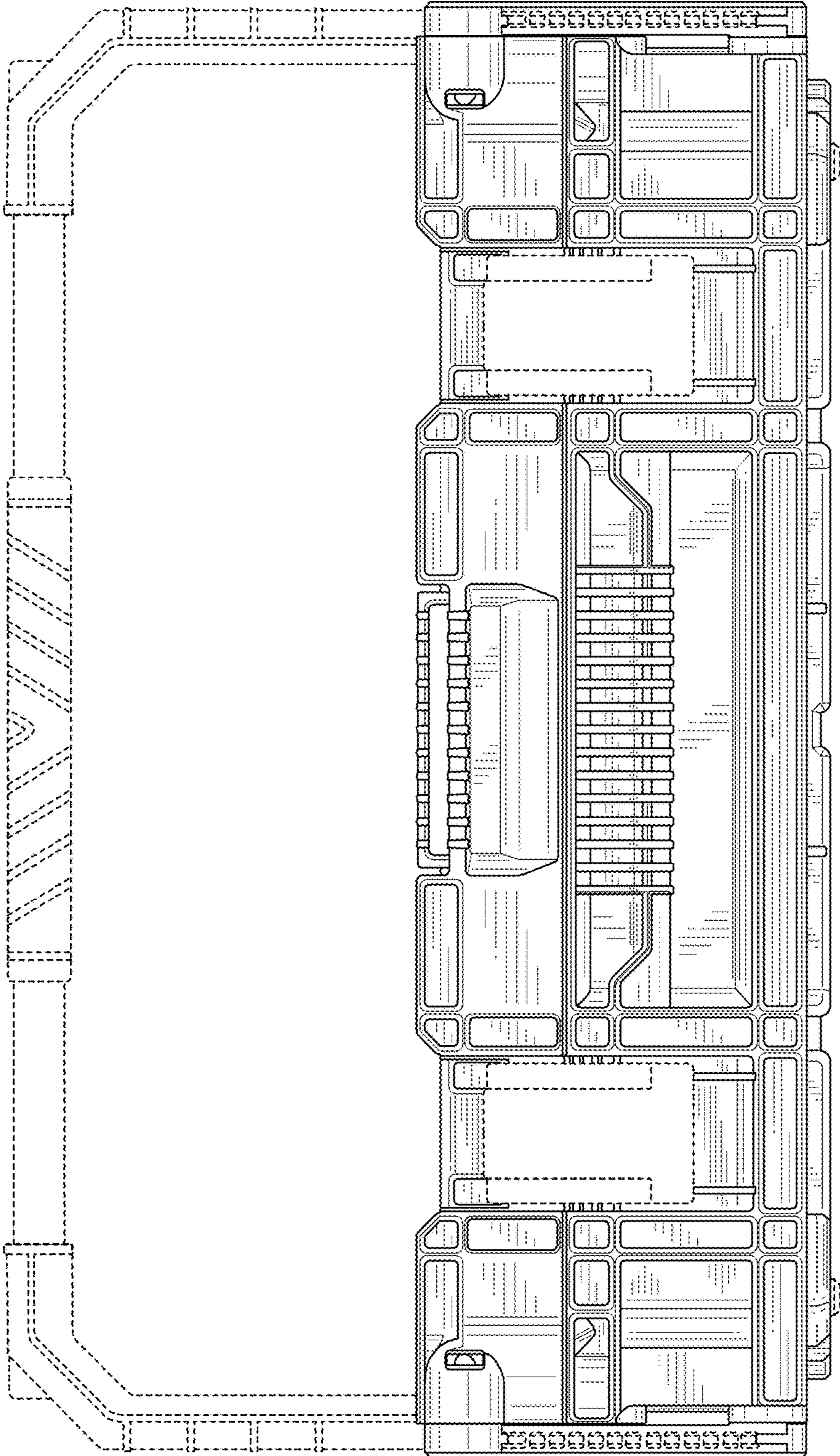

FIG. 9

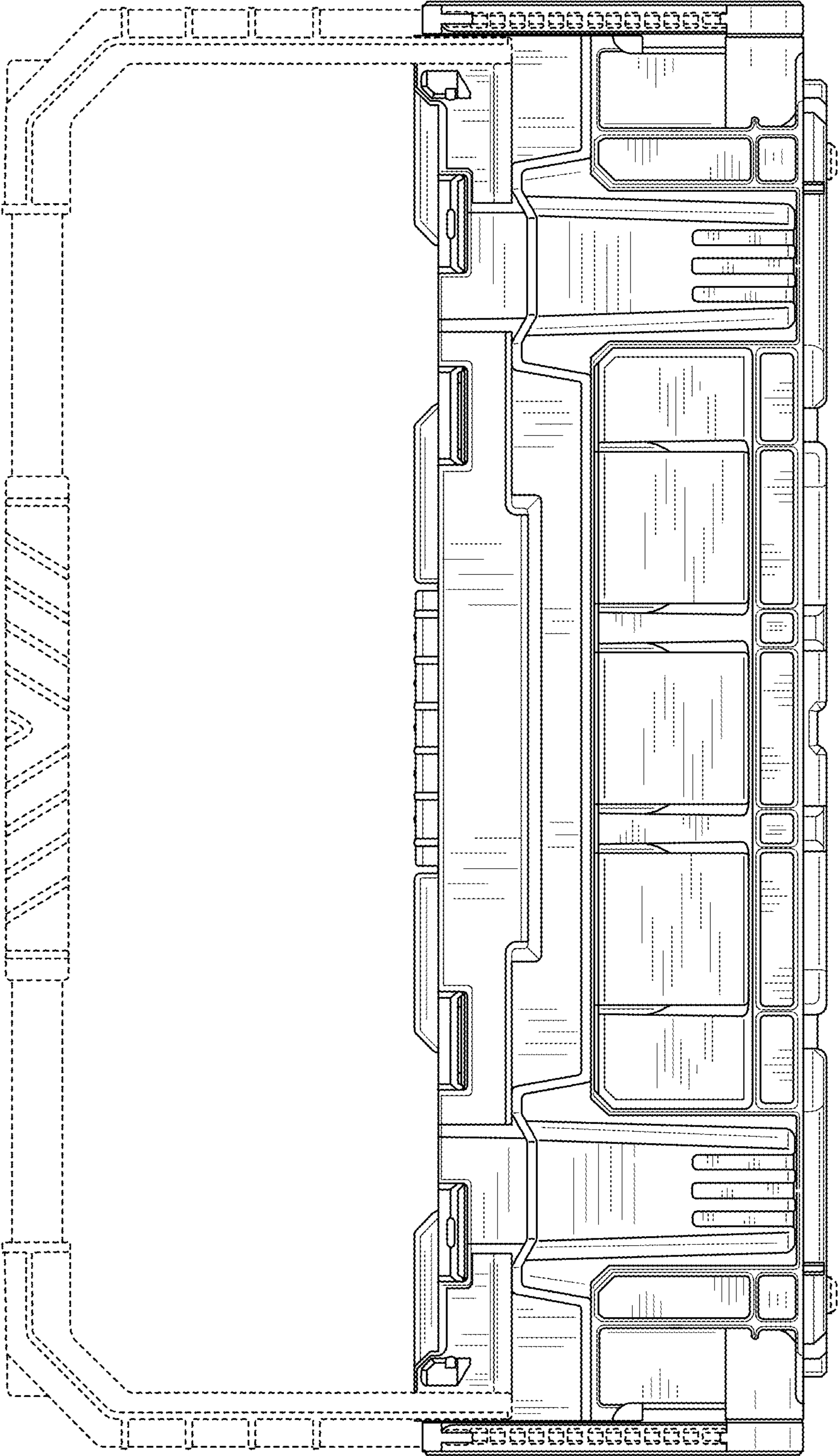

FIG. 10

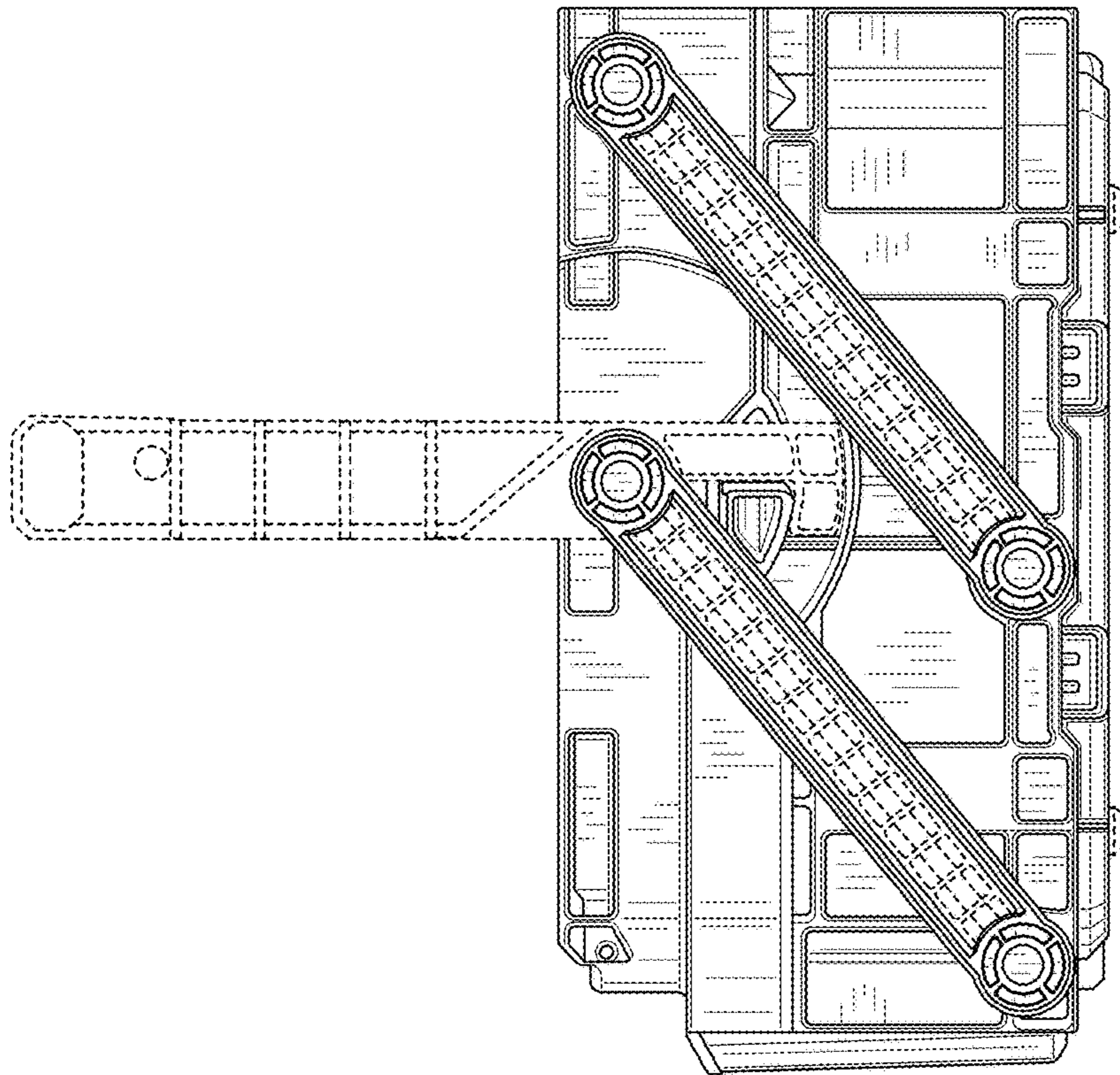

FIG. 11

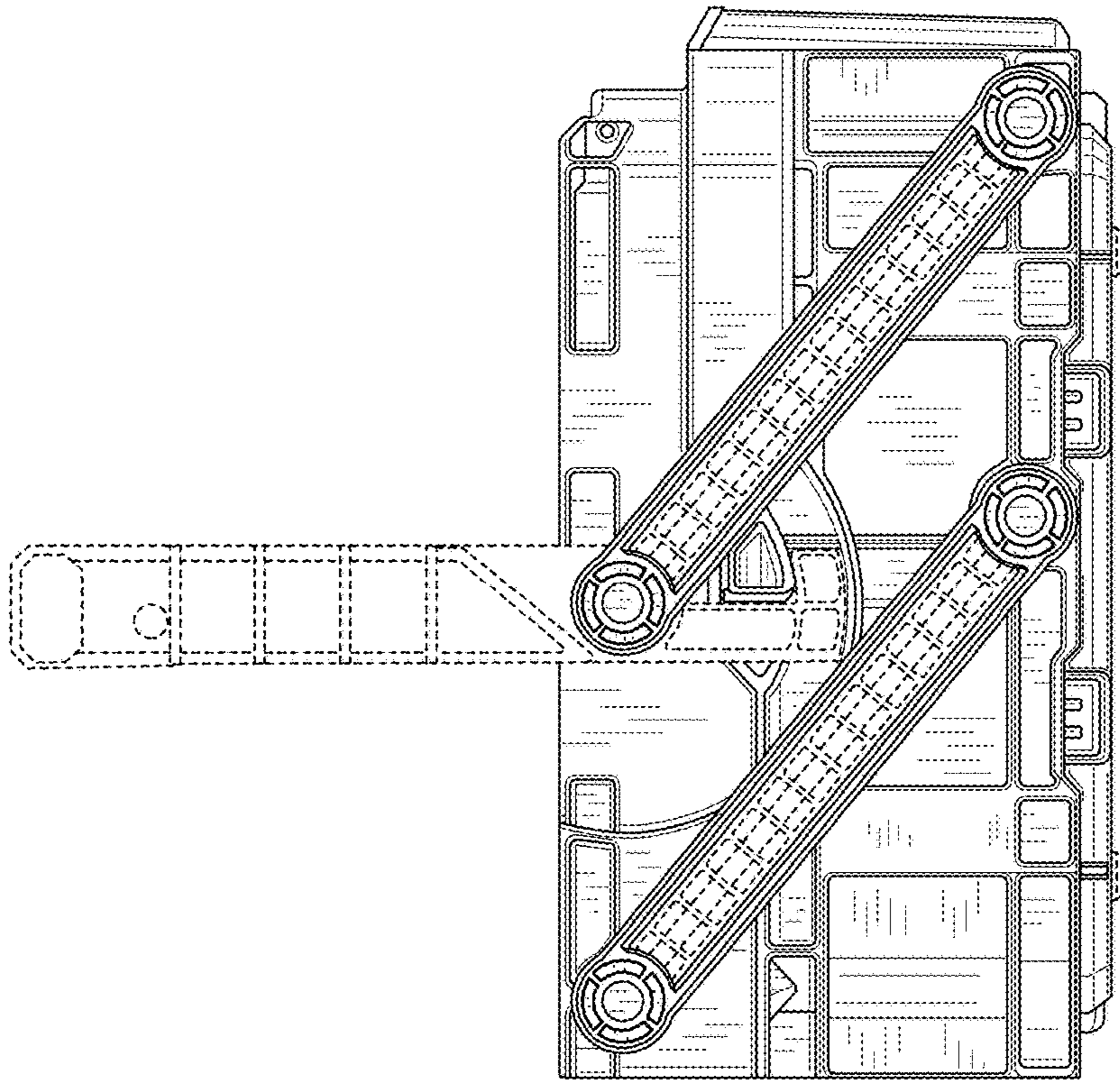

FIG. 12

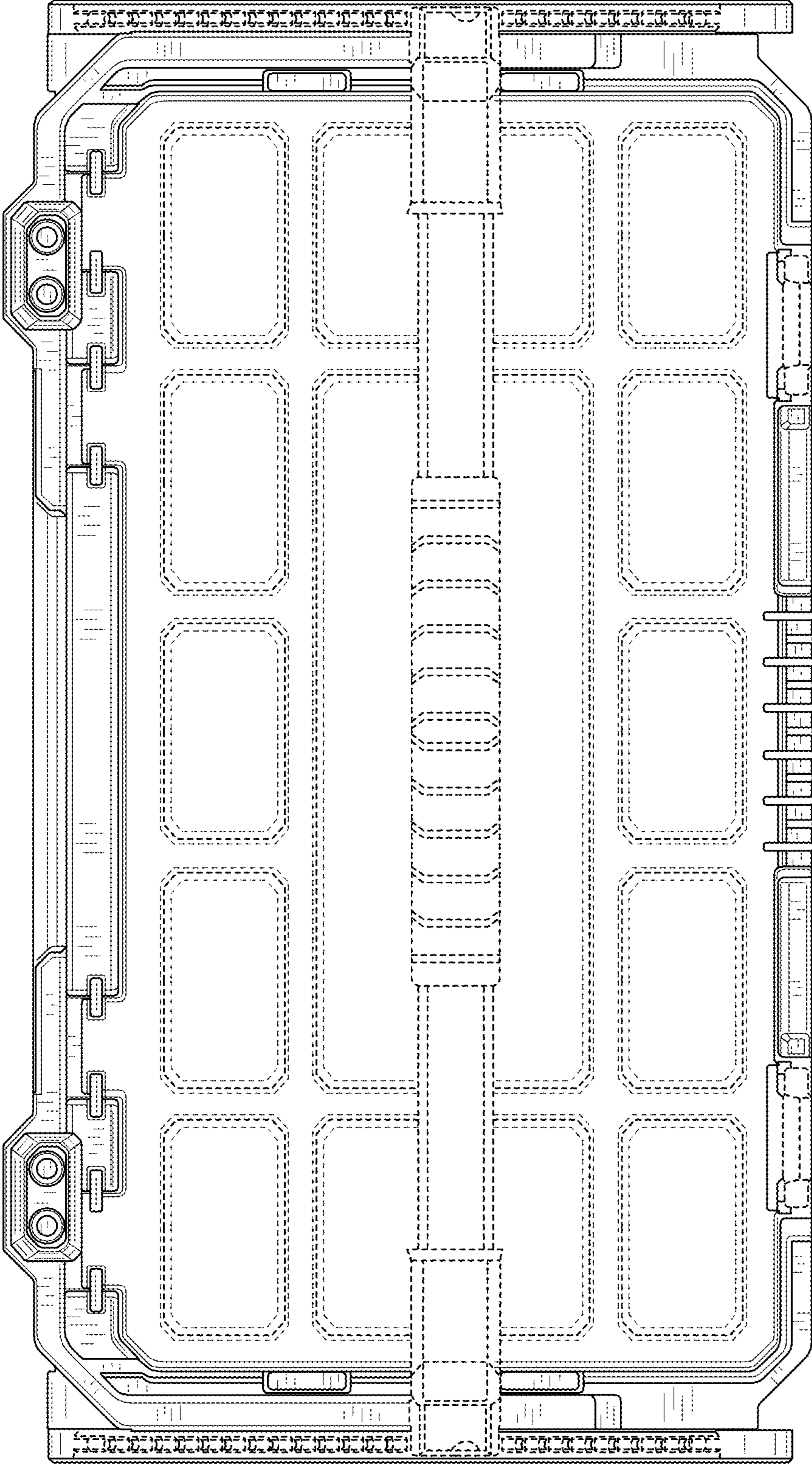

FIG. 13

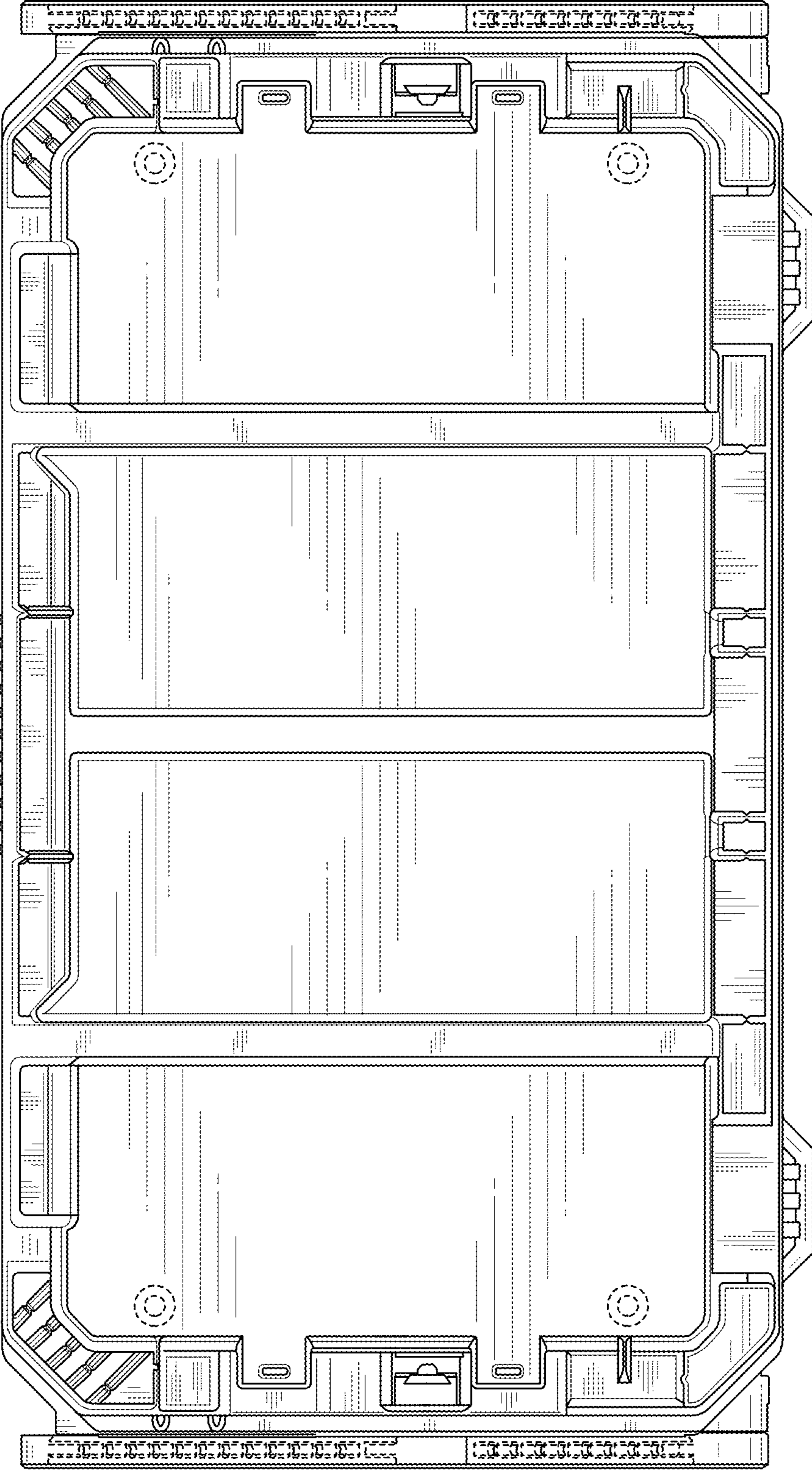

FIG. 14