



US00D816286S

(12) **United States Design Patent**  
**Kim**

(10) **Patent No.:** **US D816,286 S**

(45) **Date of Patent:** **\*\* Apr. 24, 2018**

(54) **SPONGE AND DISH SOAP HOLDER**

D767,841 S \* 9/2016 Cotter ..... D32/55  
D794,893 S \* 8/2017 Libman ..... D32/55  
D799,133 S \* 10/2017 Wong ..... D32/55

(71) Applicant: **Helen of Troy Limited**, Belleville, St. Michael (BB)

\* cited by examiner

(72) Inventor: **Sunny Kim**, Astoria, NY (US)

*Primary Examiner* — Austin Murphy

(73) Assignee: **Helen of Troy Limited**, Belleville, St. Michael (BB)

(74) *Attorney, Agent, or Firm* — Rankin, Hill & Clark LLP

(\*\*) Term: **15 Years**

(57) **CLAIM**

(21) Appl. No.: **29/580,323**

The ornamental design for a sponge and dish soap holder, as shown and described.

(22) Filed: **Oct. 7, 2016**

(51) **LOC (11) Cl.** ..... **07-05**

(52) **U.S. Cl.**  
USPC ..... **D32/55**

**DESCRIPTION**

(58) **Field of Classification Search**  
USPC ..... D32/55, 276, 3; D6/510, 525; D30/133;  
211/41.5, 41.4, 41.3, 41.8; 361/679.4;  
312/311, 333, 334.4; D7/354, 629  
CPC .. A47L 15/505; A47L 15/503; A47L 15/0013;  
A47L 19/02; A47L 19/04; A47J 47/20  
See application file for complete search history.

FIG. 1 is a perspective view of a sponge and dish soap holder with a movable flap in a first orientation; FIG. 2 is a left side elevation view thereof; FIG. 3 is a right side elevation view thereof; FIG. 4 is a rear elevation view thereof; FIG. 5 is a front elevation view thereof; FIG. 6 is a top plan view thereof; and FIG. 7 is a bottom plan view thereof; FIG. 8 is a perspective view of a sponge and dish soap holder with the movable flap in a second orientation; FIG. 9 is a left side elevation view thereof; FIG. 10 is a right side elevation view thereof; FIG. 11 is a rear elevation view thereof; FIG. 12 is a front elevation view thereof; FIG. 13 is a top plan view thereof; and, FIG. 14 is a bottom plan view thereof.

(56) **References Cited**

U.S. PATENT DOCUMENTS

D655,472 S \* 3/2012 Krus ..... D32/55  
D692,199 S \* 10/2013 Huang ..... D32/55  
D699,012 S \* 2/2014 Ziemann ..... D32/55  
D706,009 S \* 5/2014 Cooper ..... D32/55  
D762,934 S \* 8/2016 Evans ..... D32/55  
D764,132 S \* 8/2016 Goodman ..... D32/55

**1 Claim, 14 Drawing Sheets**

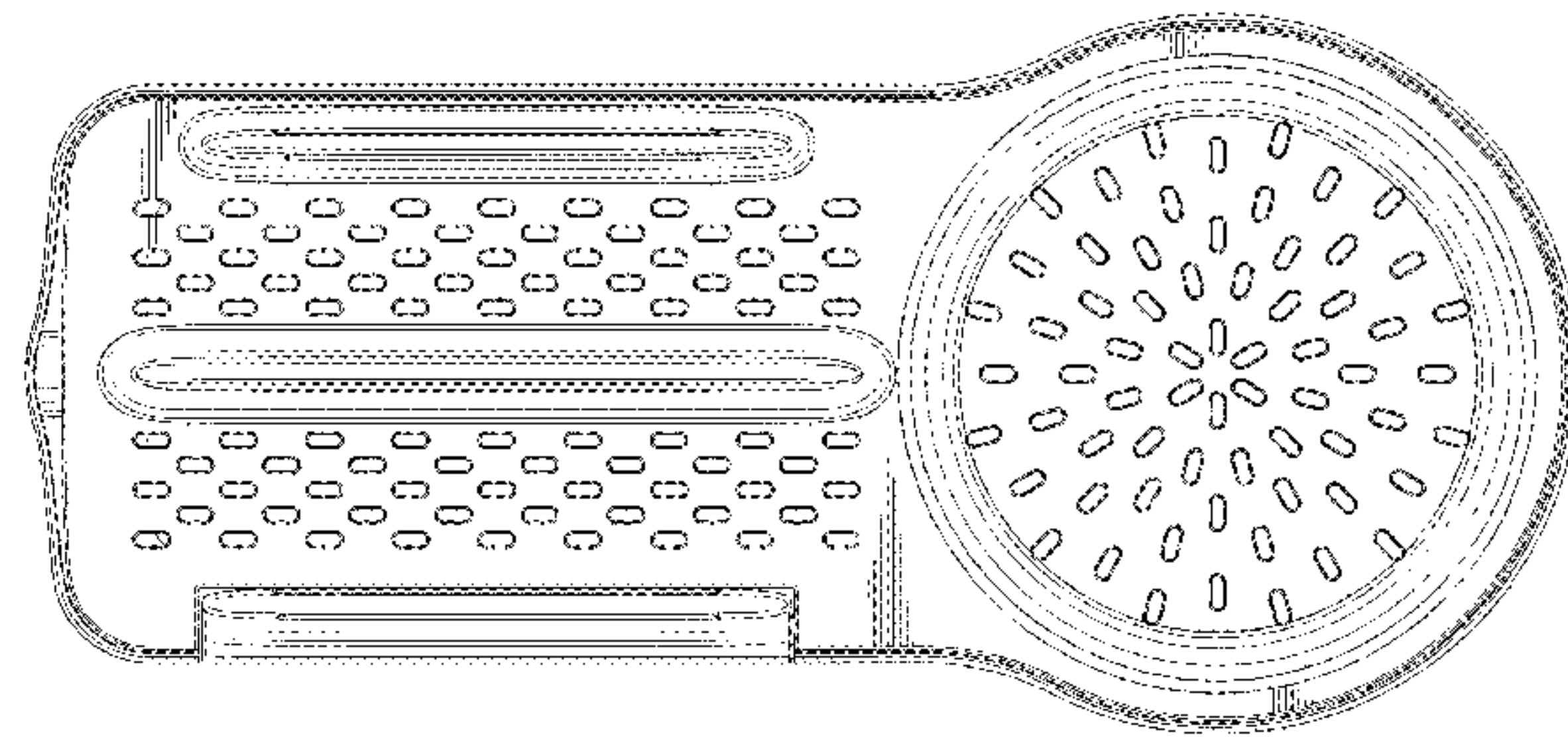
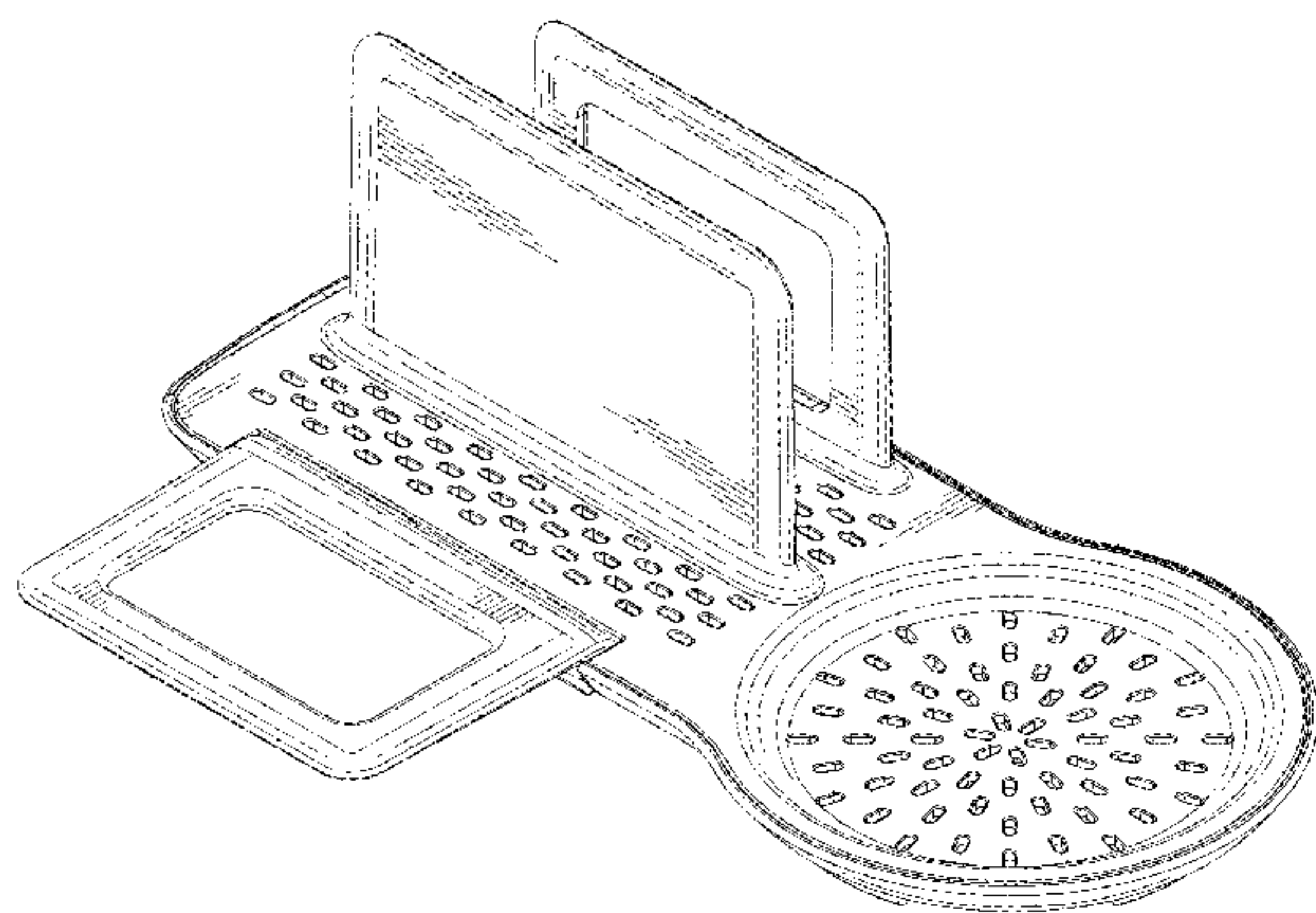

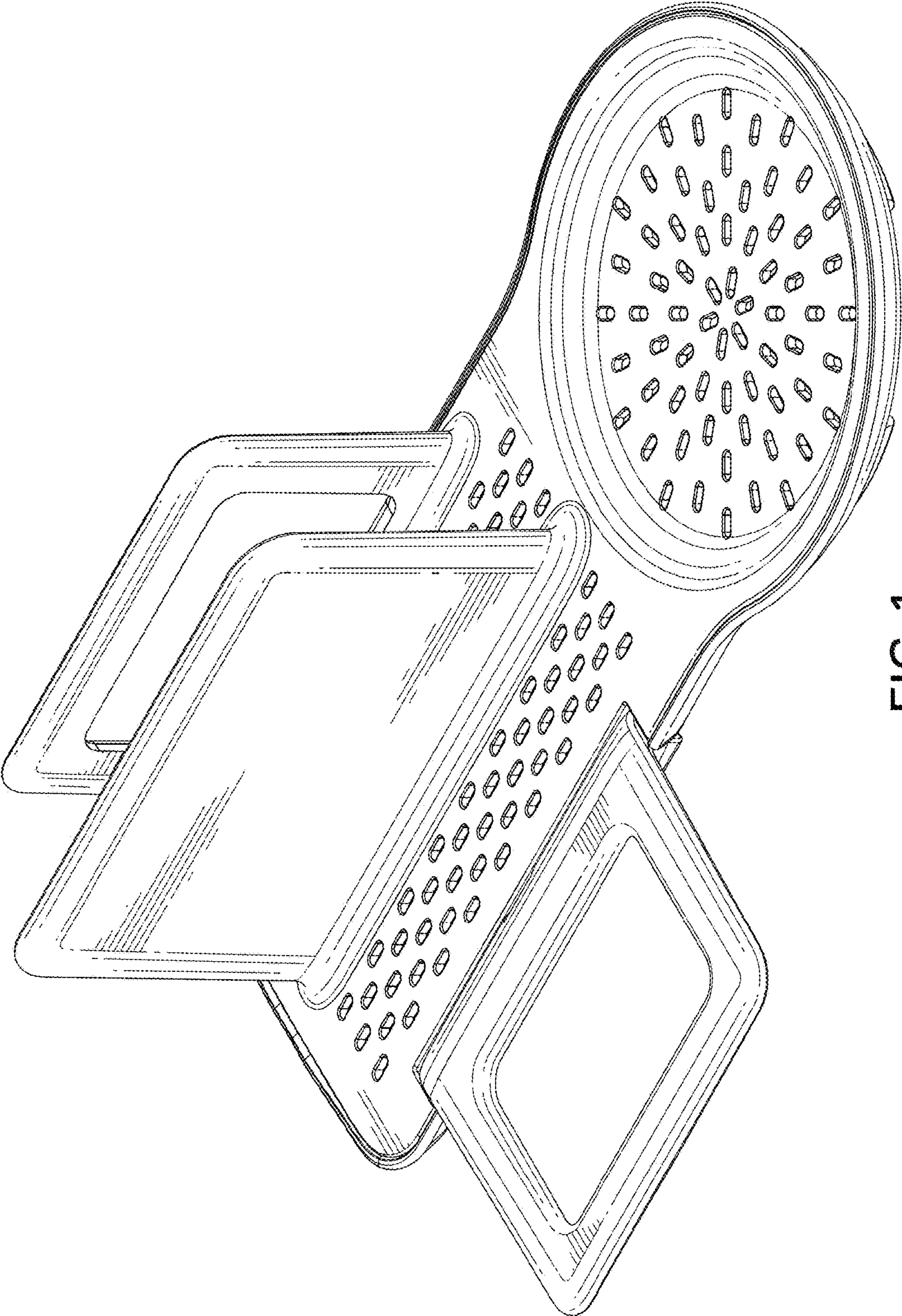

FIG.1

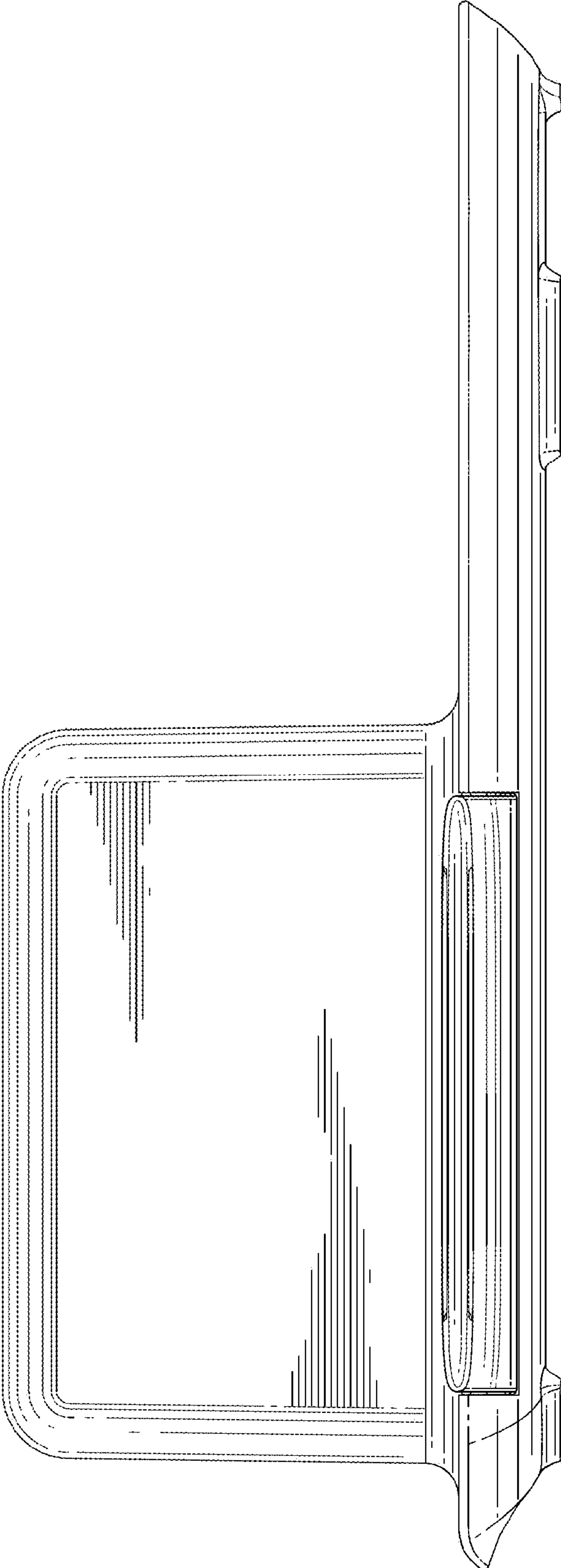

FIG. 2



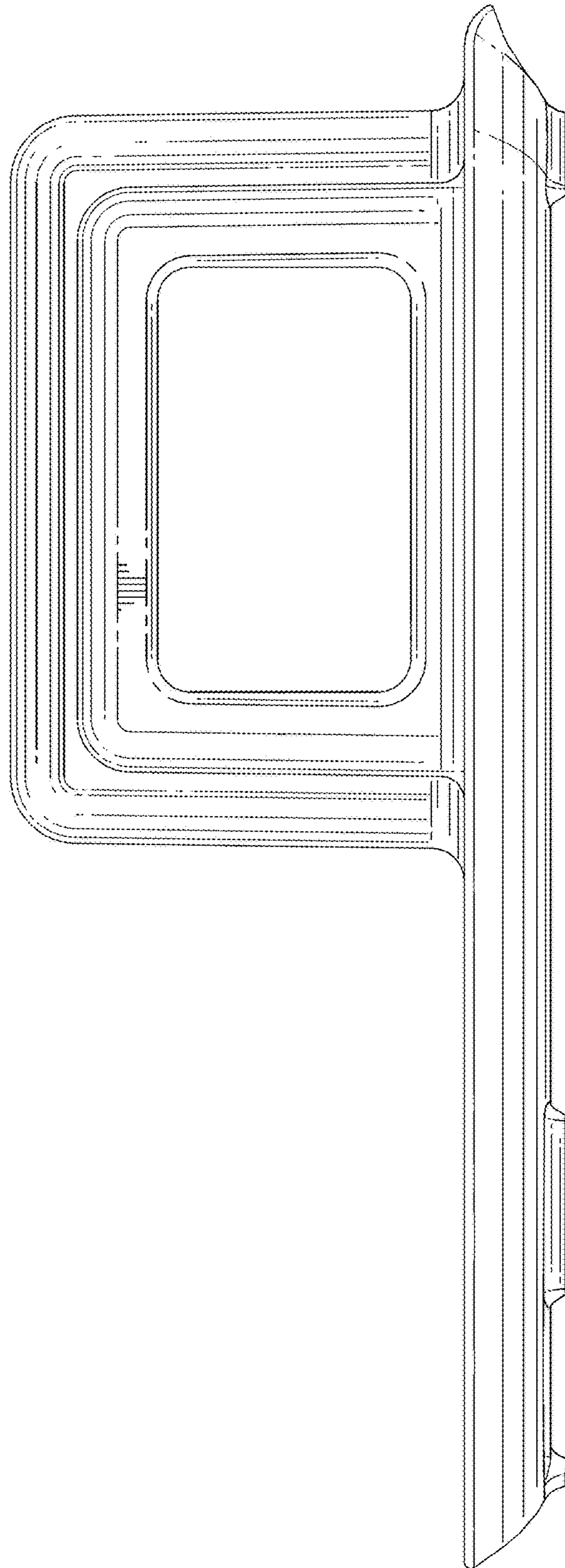

FIG. 3

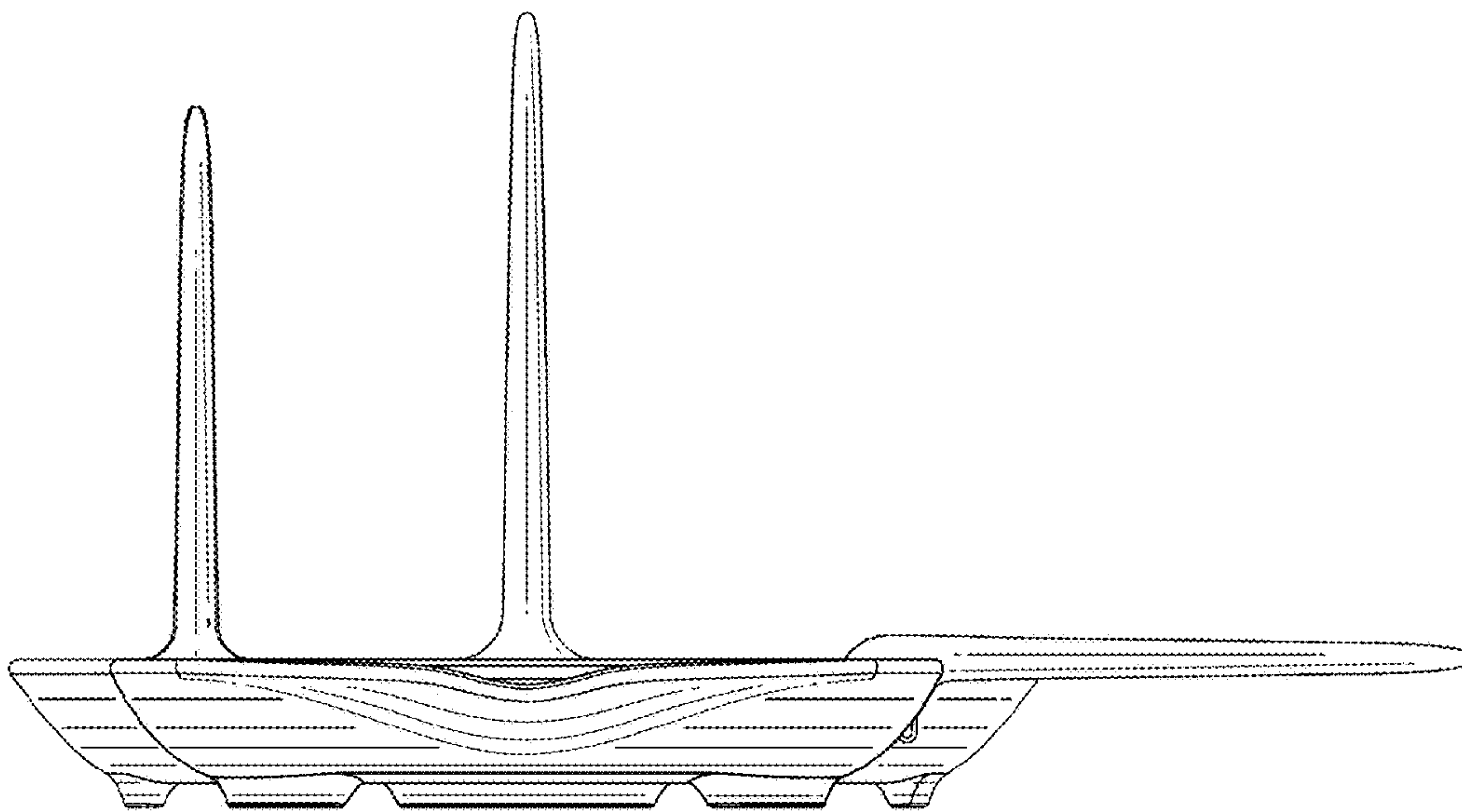

FIG.4

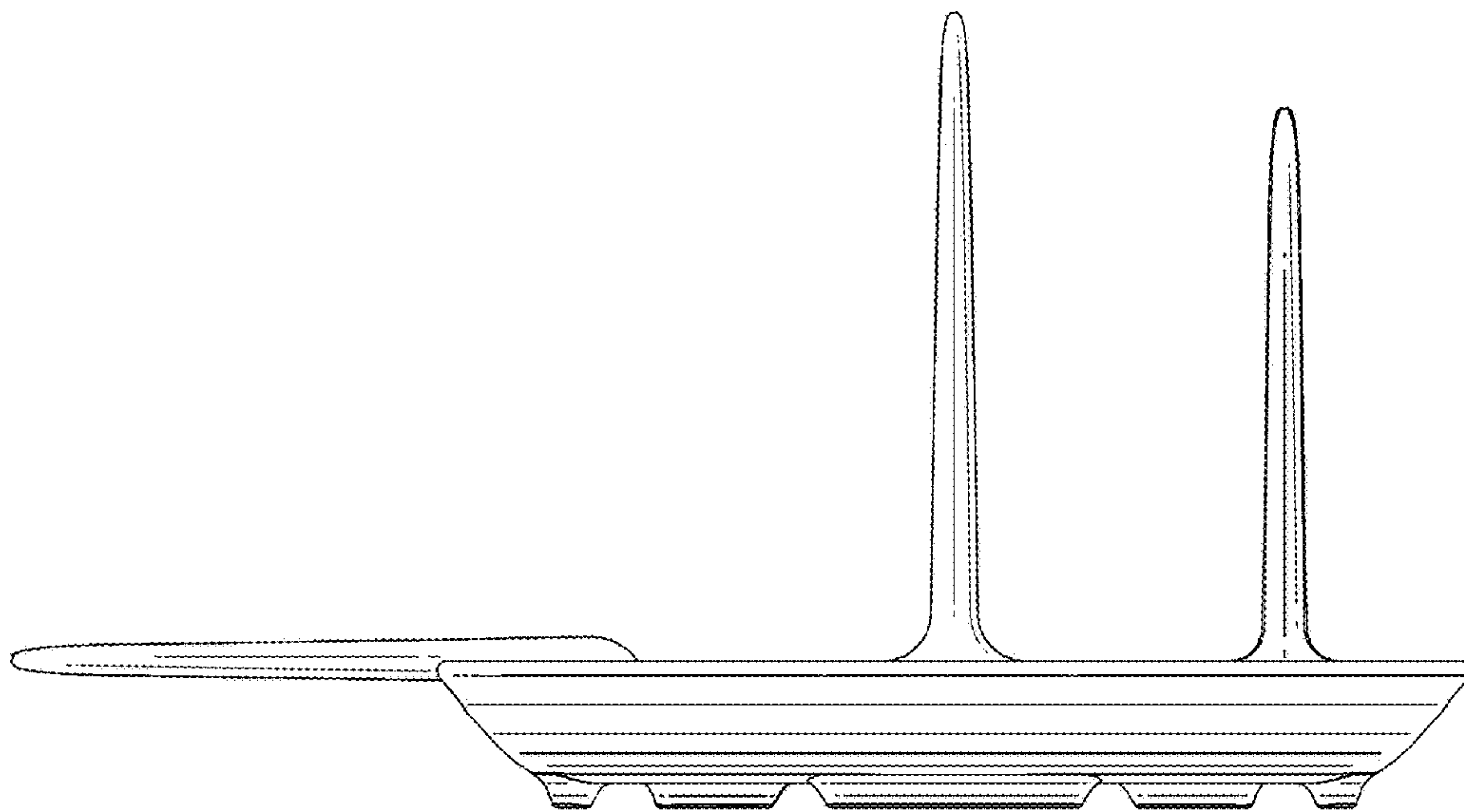

FIG. 5

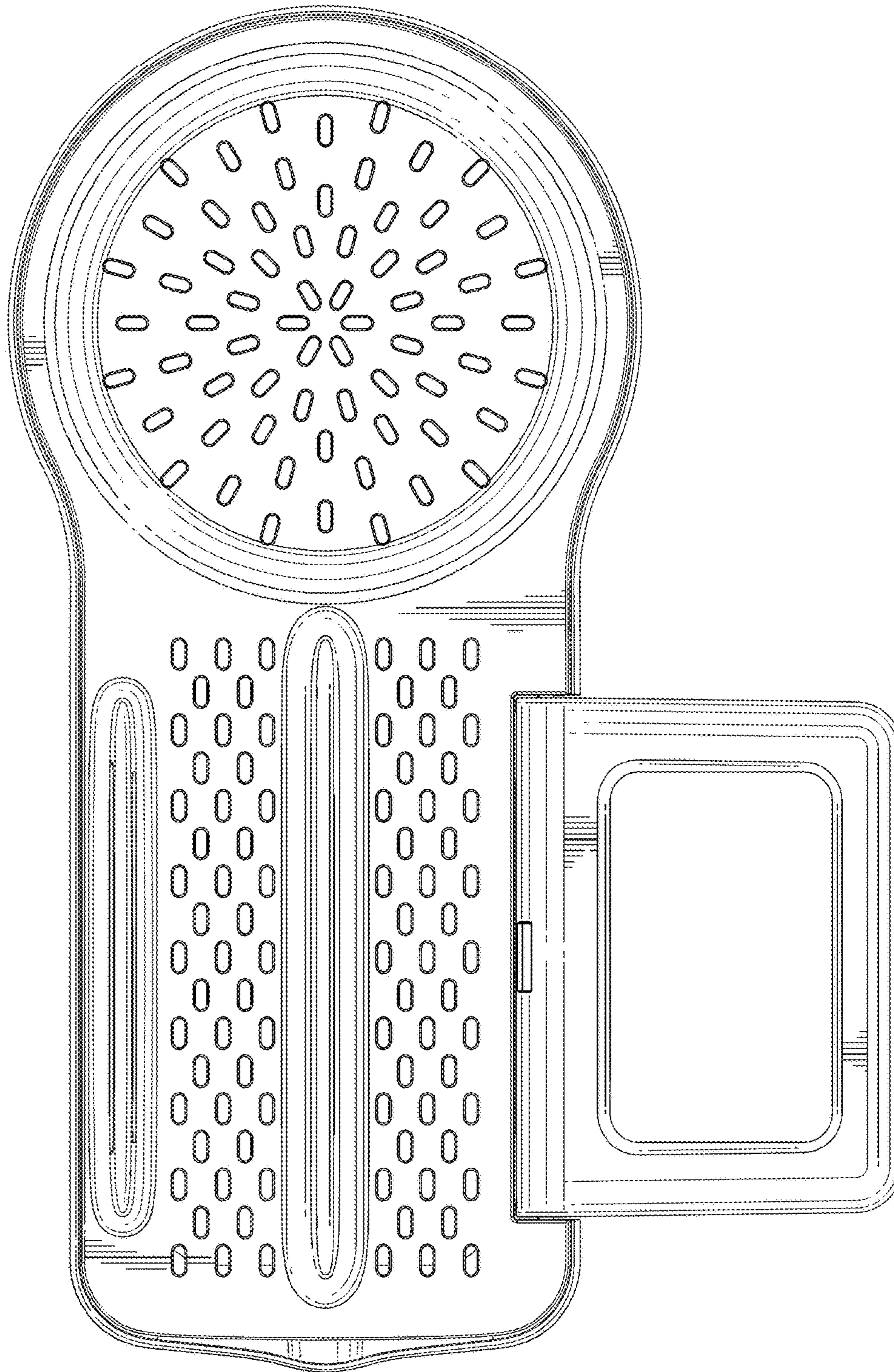

FIG.6



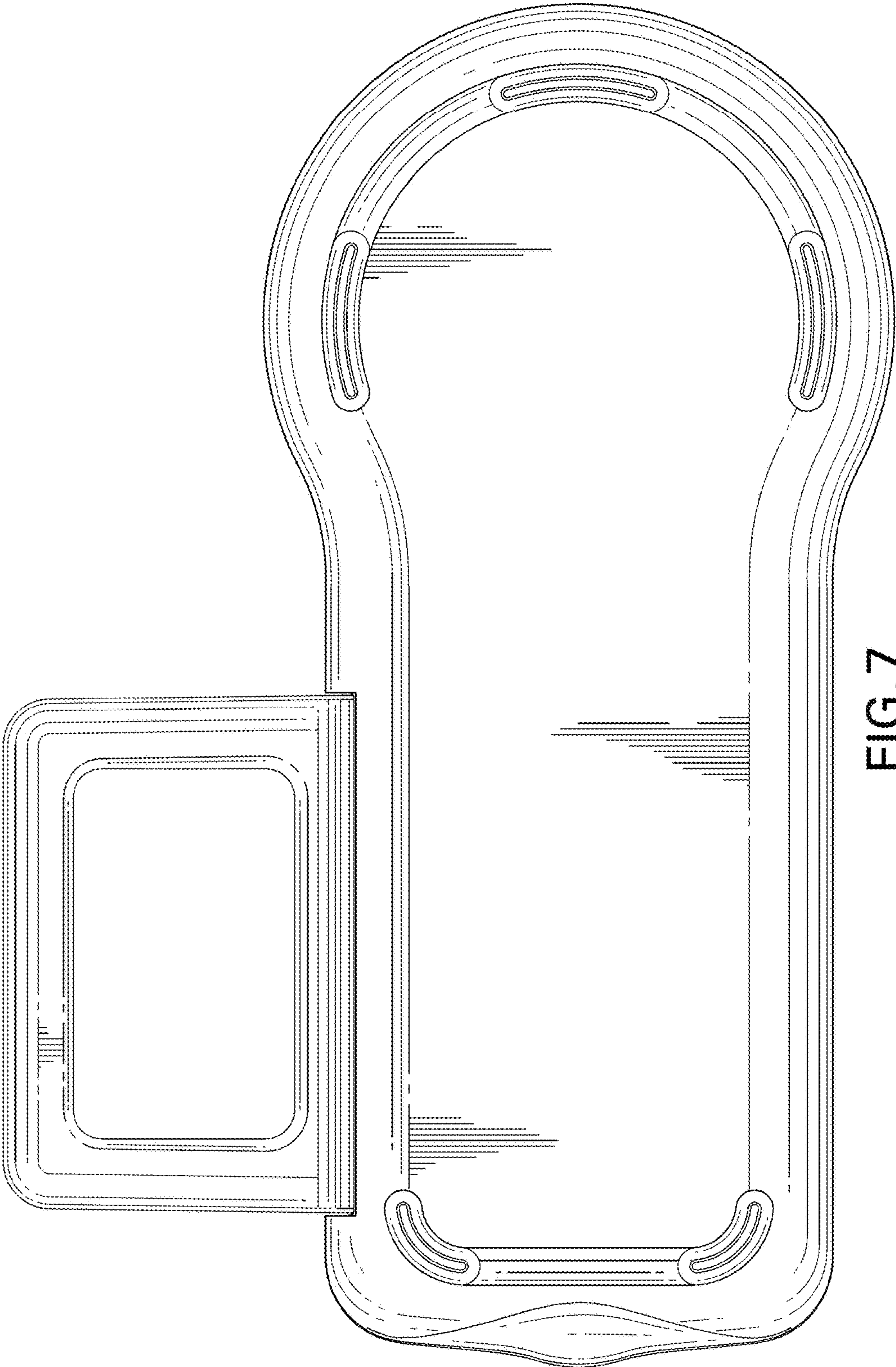

FIG. 7



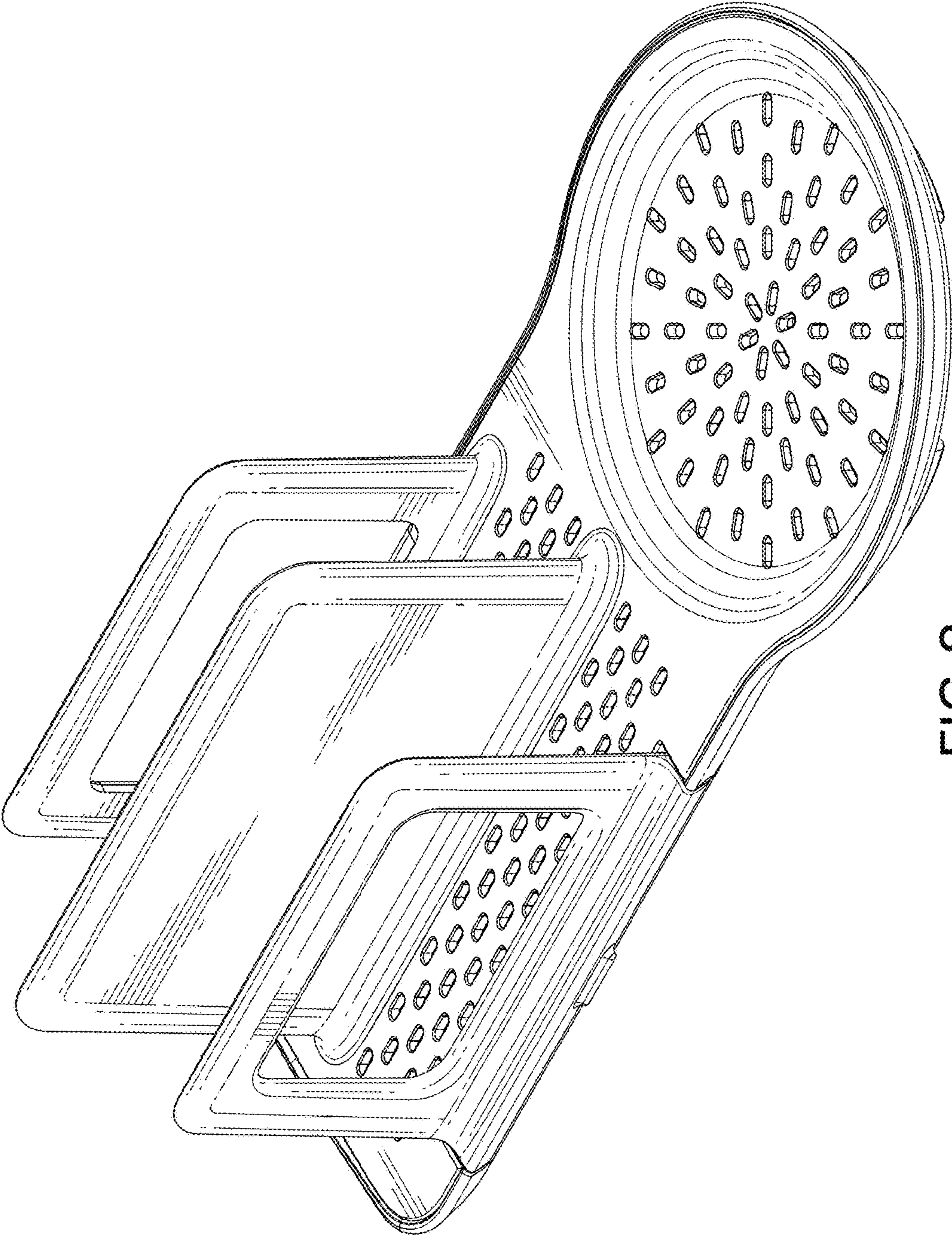

FIG. 8

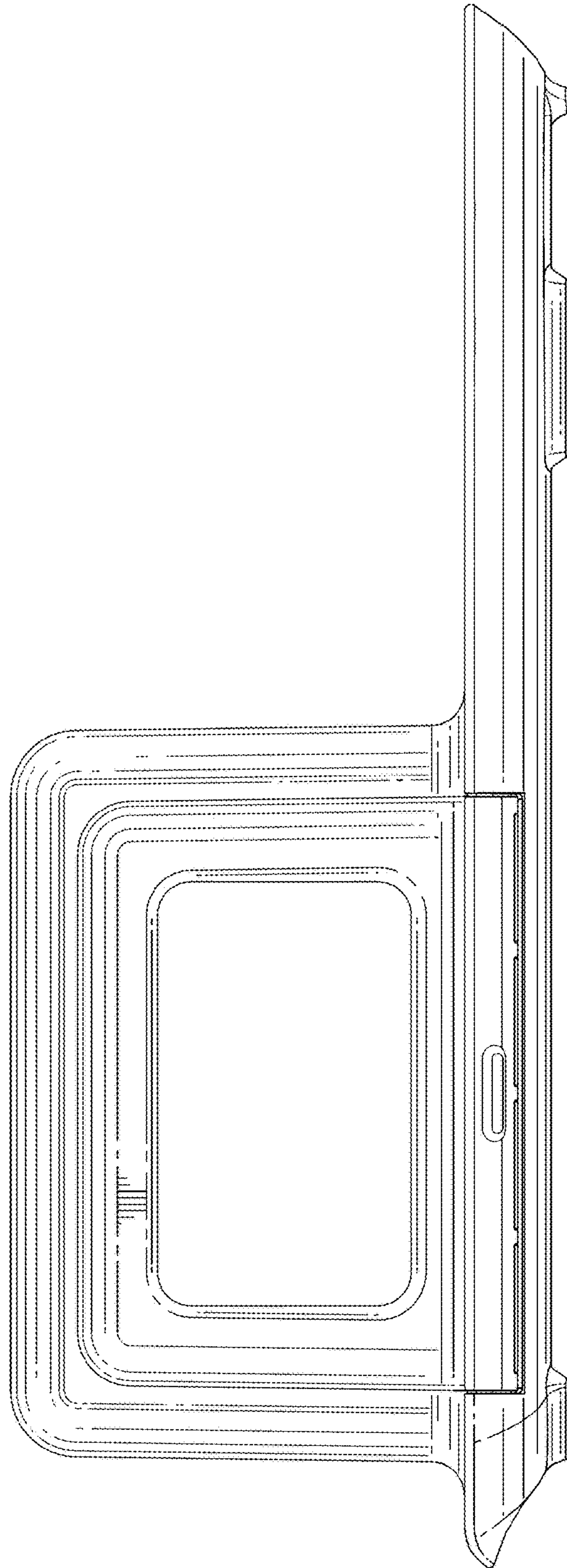

FIG. 9

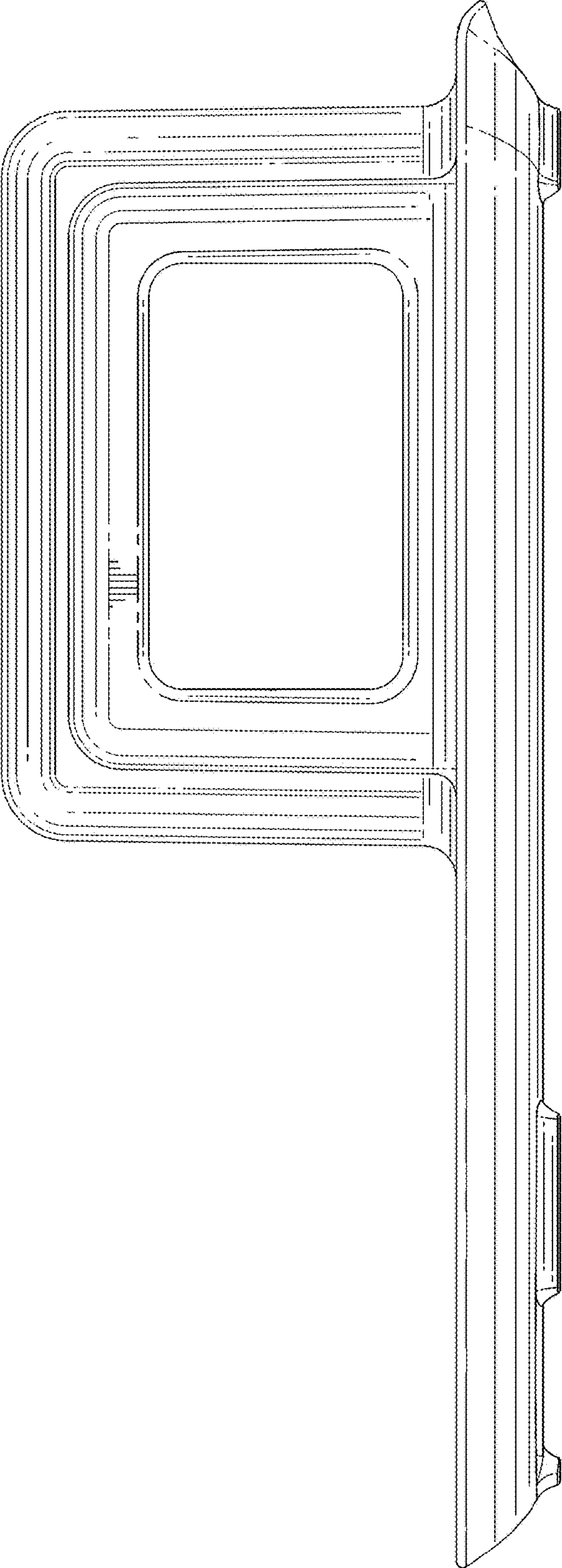

FIG.10



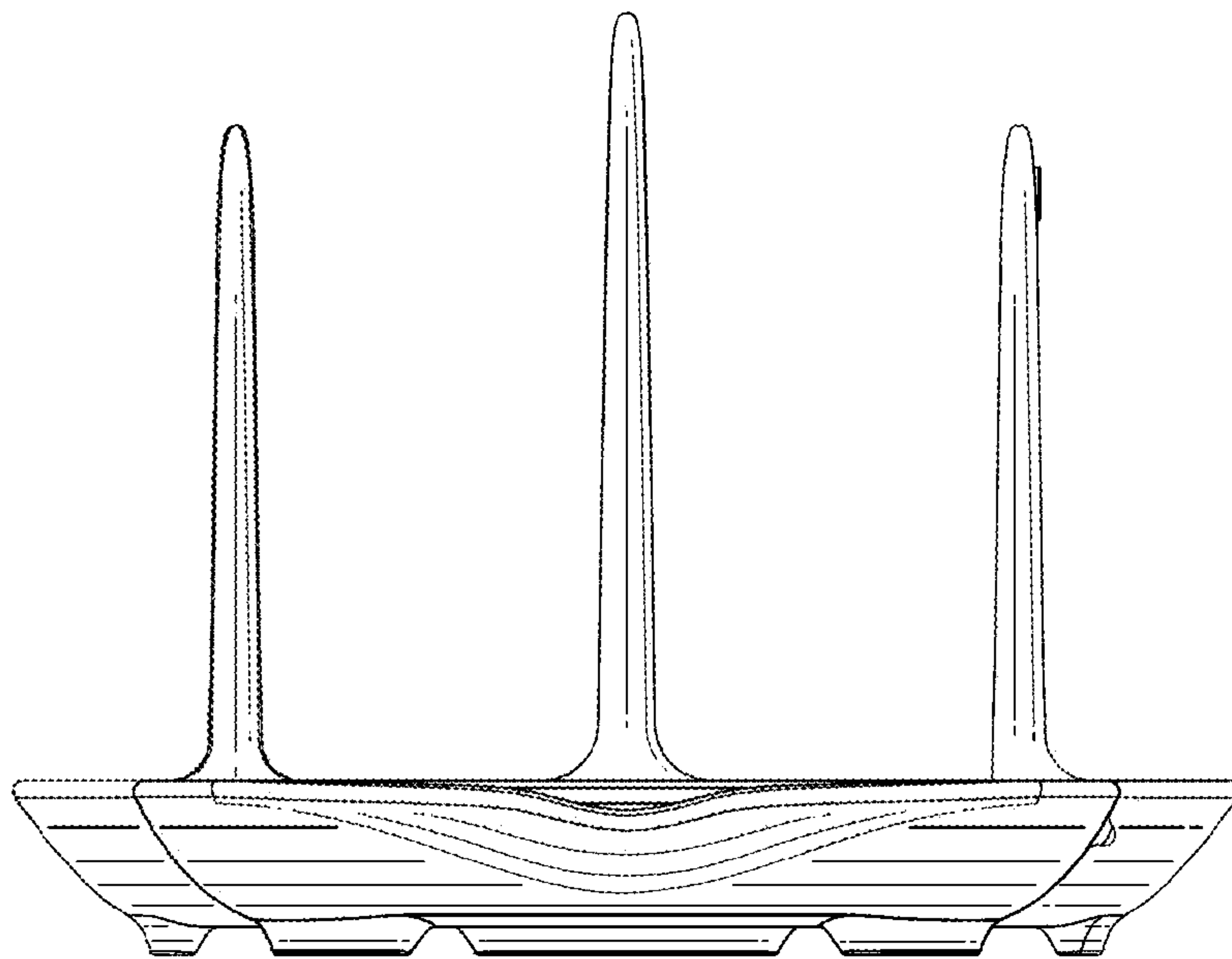

FIG. 11

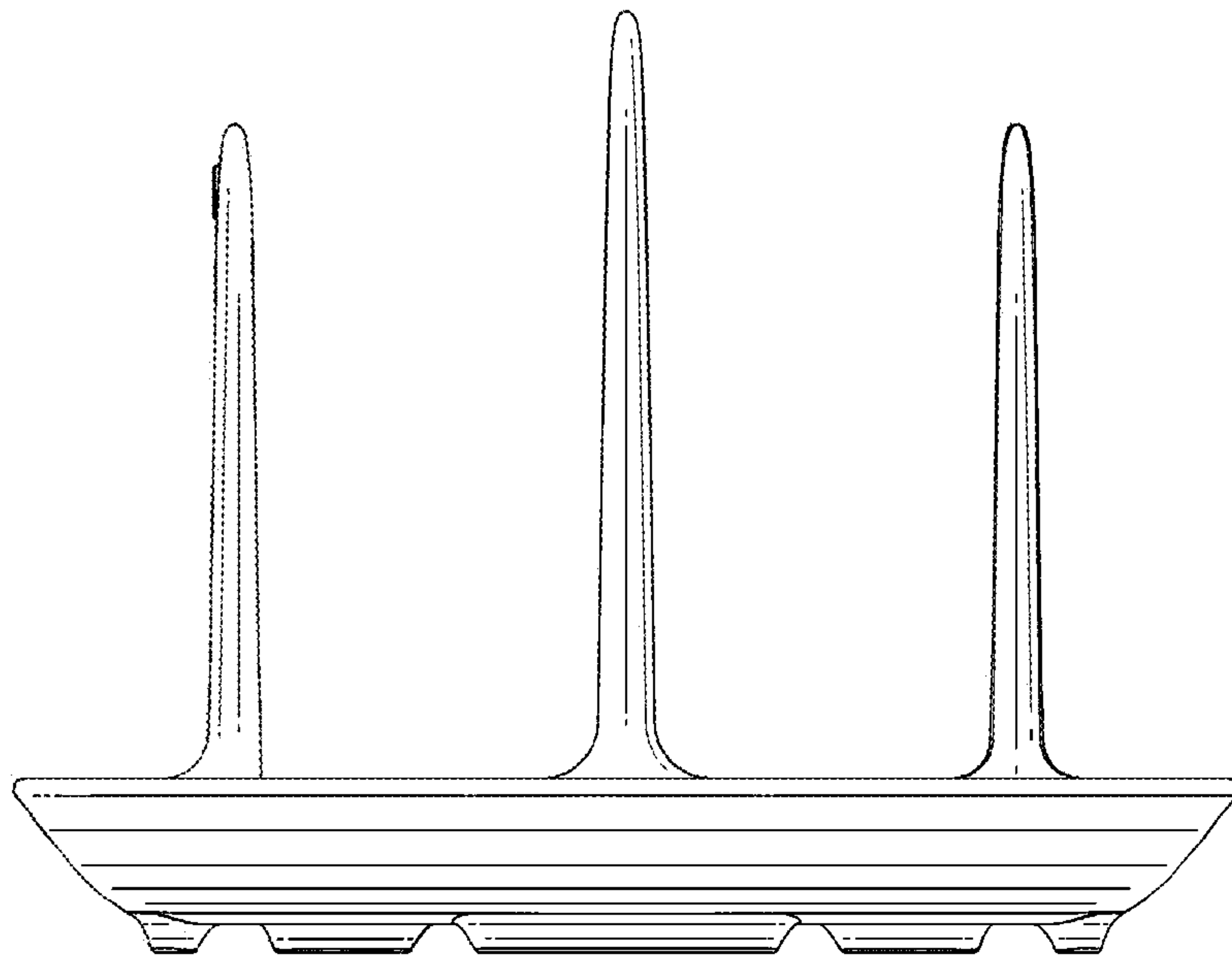

FIG. 12

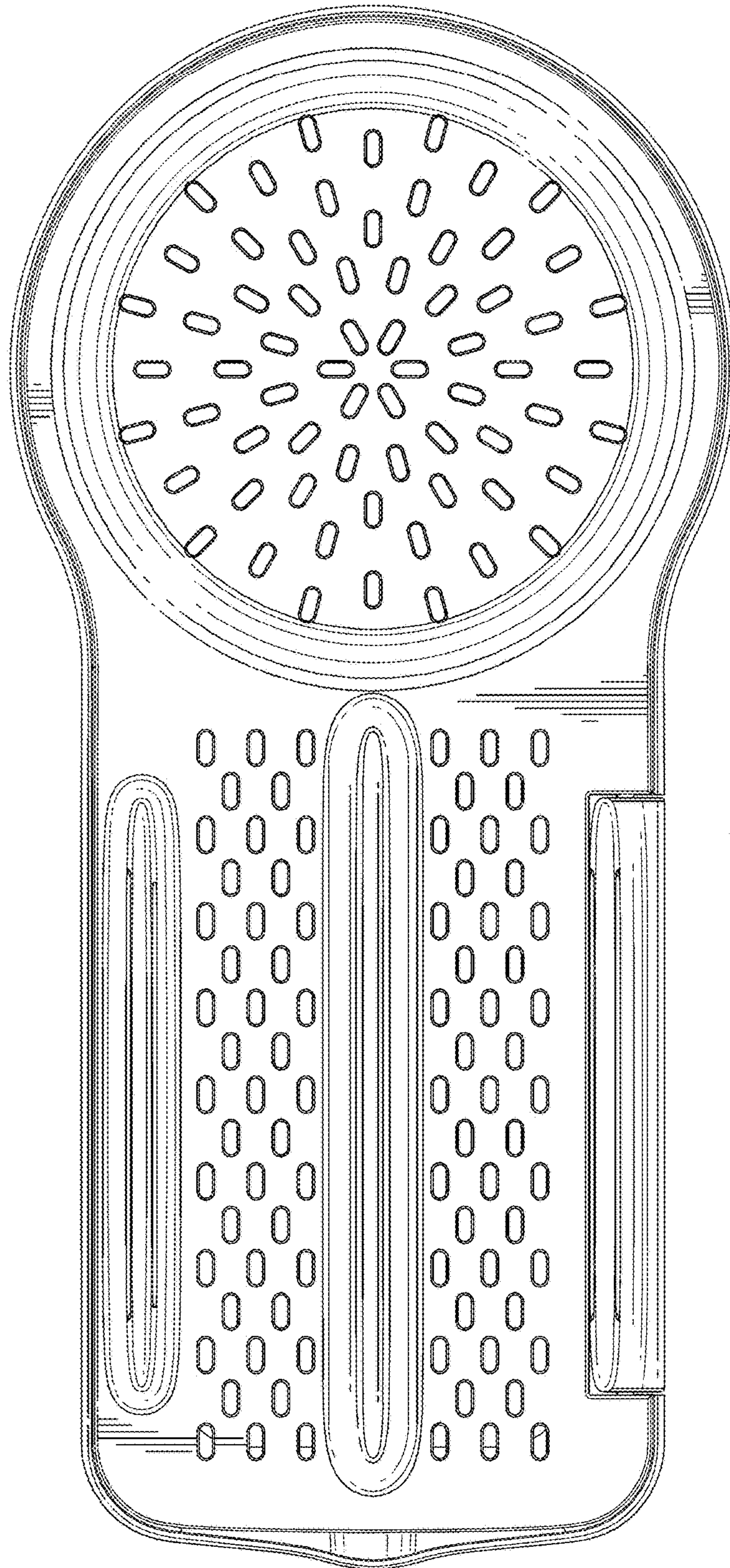

FIG.13



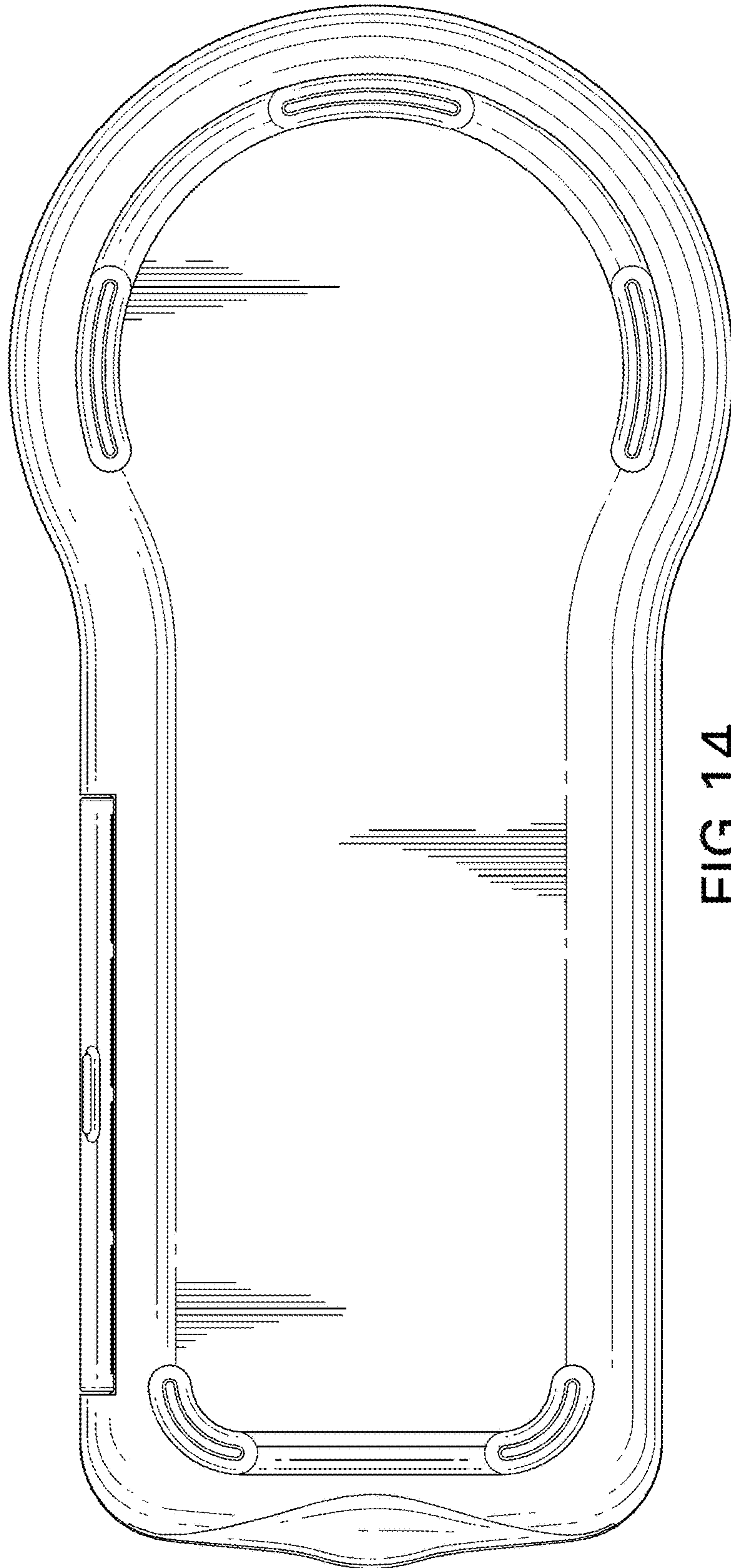

FIG.14