



US00D815998S

(12) **United States Design Patent** (10) **Patent No.:** **US D815,998 S**  
**Badstuebner et al.** (45) **Date of Patent:** **\*\* Apr. 24, 2018**

(54) **FRONT BUMPER FOR A VEHICLE**

(71) Applicant: **Daimler AG**, Stuttgart (DE)

(72) Inventors: **Achim-Dietrich Badstuebner**, Munich (DE); **Mark Fetherston**, Stuttgart (DE); **Robert Lesnik**, Leonberg (DE)

(73) Assignee: **Daimler AG**, Stuttgart (DE)

(\*\*) Term: **15 Years**

(21) Appl. No.: **29/587,213**

(22) Filed: **Dec. 12, 2016**

(30) **Foreign Application Priority Data**

Aug. 2, 2016 (WO) ..... DM/093195

(51) **LOC (11) Cl.** ..... **12-16**

(52) **U.S. Cl.**  
USPC ..... **D12/169**

(58) **Field of Classification Search**  
USPC .... D12/169, 216, 90-92, 86, 171, 196, 163;  
293/102, 113, 115, 117, 120; 296/180.1,  
296/180.2

CPC ..... B60R 19/02; B60R 19/04; B62D 25/08  
See application file for complete search history.

(56) **References Cited**

**U.S. PATENT DOCUMENTS**

D580,826 S	*	11/2008	Rhoades	.....	D12/92
D656,871 S	*	4/2012	Fetherston	.....	D12/169
D664,070 S	*	7/2012	Futschik	.....	D12/92
D664,078 S	*	7/2012	Futschik	.....	D12/164
D664,901 S	*	8/2012	Futschik	.....	D12/169
D670,627 S		11/2012	Fetherston et al.		
D686,546 S	*	7/2013	Fetherston	.....	D12/169
D691,526 S	*	10/2013	Uchino	.....	D12/169
D701,798 S	*	4/2014	Futschik	.....	D12/164
D711,796 S	*	8/2014	Futschik	.....	D12/169

D716,198 S	*	10/2014	Futschik	.....	D12/164
D718,676 S	*	12/2014	Ishizuka	.....	D12/169
D718,677 S	*	12/2014	Whang	.....	D12/169
D744,914 S	*	12/2015	Loeb	.....	D12/169
D747,671 S	*	1/2016	Frei	.....	D12/164
D751,464 S	*	3/2016	Frei	.....	D12/91
D758,258 S	*	6/2016	Lesnik	.....	D12/164
D773,349 S	*	12/2016	Munakata	.....	D12/169
D781,189 S	*	3/2017	Kim	.....	D12/169
D786,748 S	*	5/2017	Hellwig	.....	D12/169
D790,414 S	*	6/2017	Futschik	.....	D12/164
D793,925 S	*	8/2017	Park	.....	D12/169
D799,378 S	*	10/2017	Lee	.....	D12/92
D805,958 S	*	12/2017	Lesnik	.....	D12/91
D808,305 S	*	1/2018	Badstuebner	.....	D12/92

\* cited by examiner

*Primary Examiner* — Melody N Brown

(74) *Attorney, Agent, or Firm* — Crowell & Moring LLP

(57) **CLAIM**

The ornamental design for a front bumper for a vehicle, as shown and described.

**DESCRIPTION**

This application contains subject matter related to the following co-pending U.S. design patent applications:

Application Ser. No. 29/587,209, filed herewith and entitled “Vehicle, Toy, and/or Replicas Thereof”; and

Application Ser. No. 29/587,213, filed herewith and entitled “Front Portion of a Vehicle, Toy, and/or Replicas Thereof”.

FIG. 1 is a left, front perspective view of a front bumper for a vehicle according to the design;

FIG. 2 is a front view thereof;

FIG. 3 is a right side view thereof;

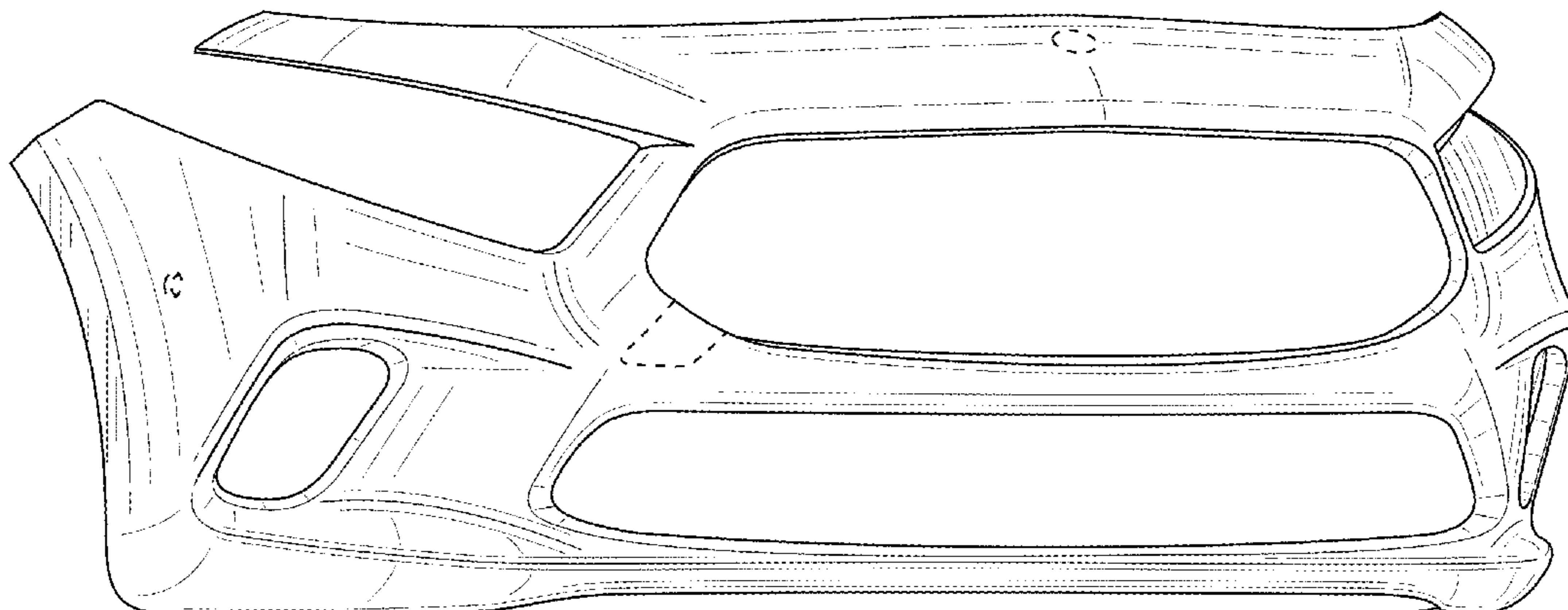
FIG. 4 is a left side view thereof;

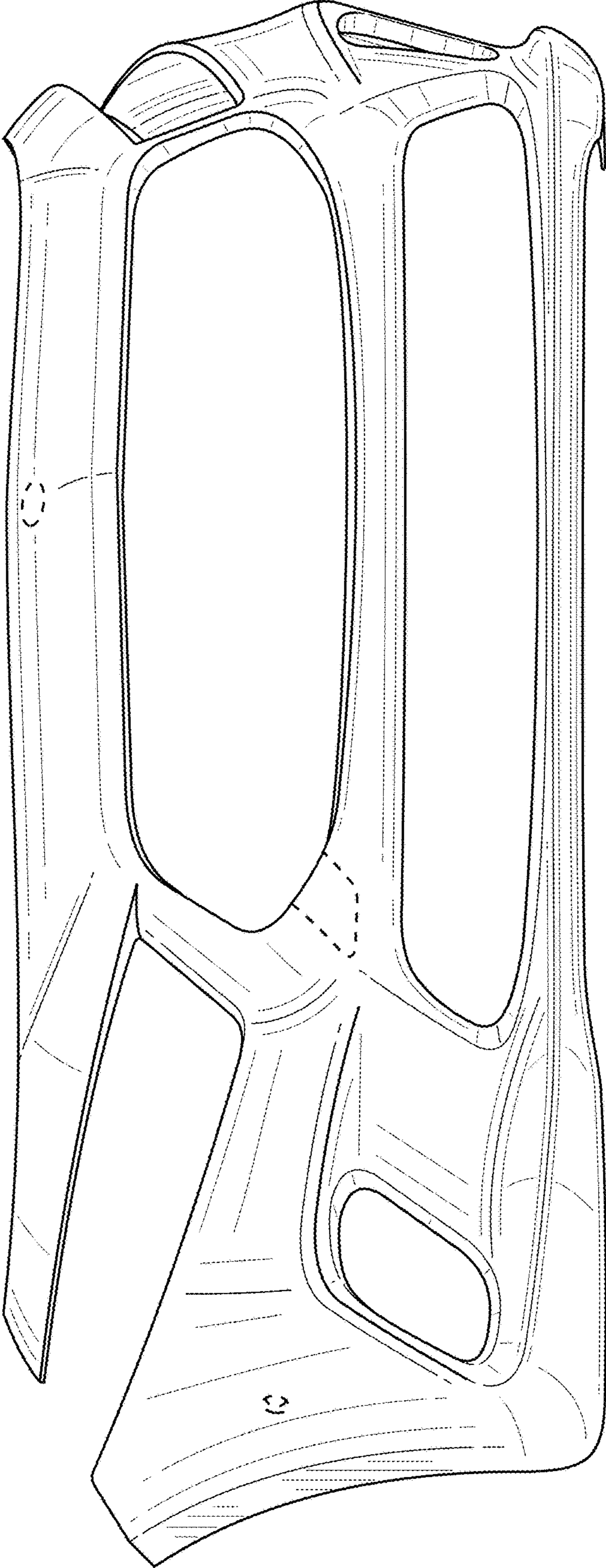
FIG. 5 is a bottom view thereof; and,

FIG. 6 is a top view thereof.

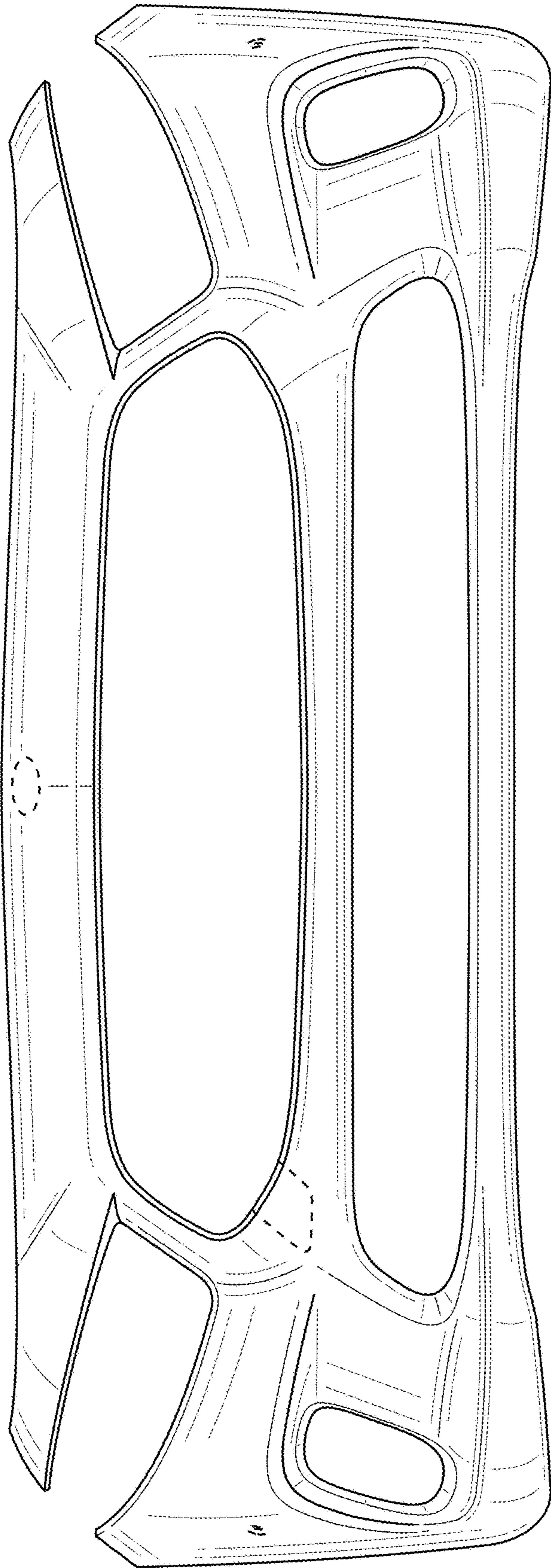
The broken lines are for illustrative purposes only and form no part of the claimed design.

**1 Claim, 6 Drawing Sheets**

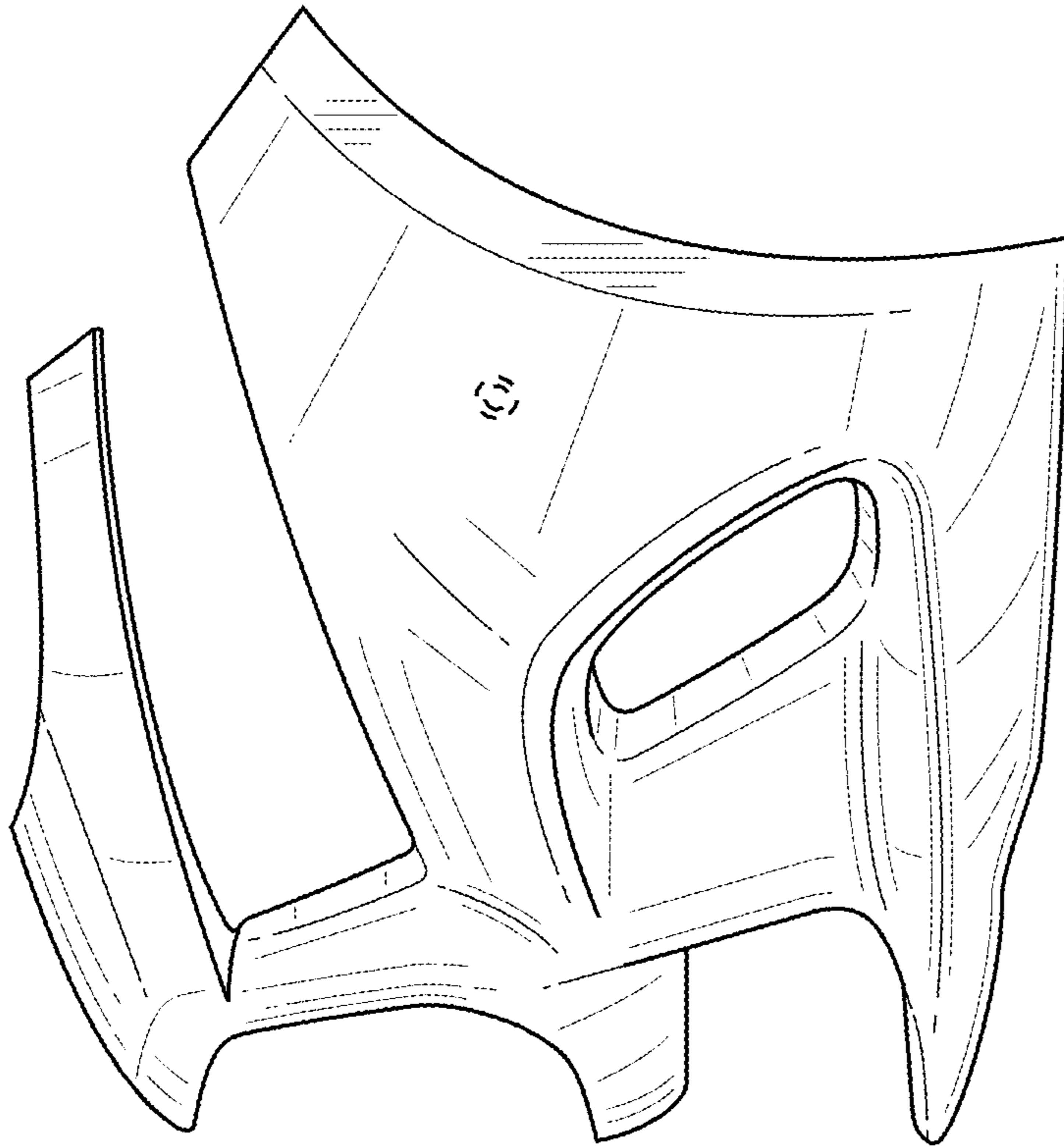




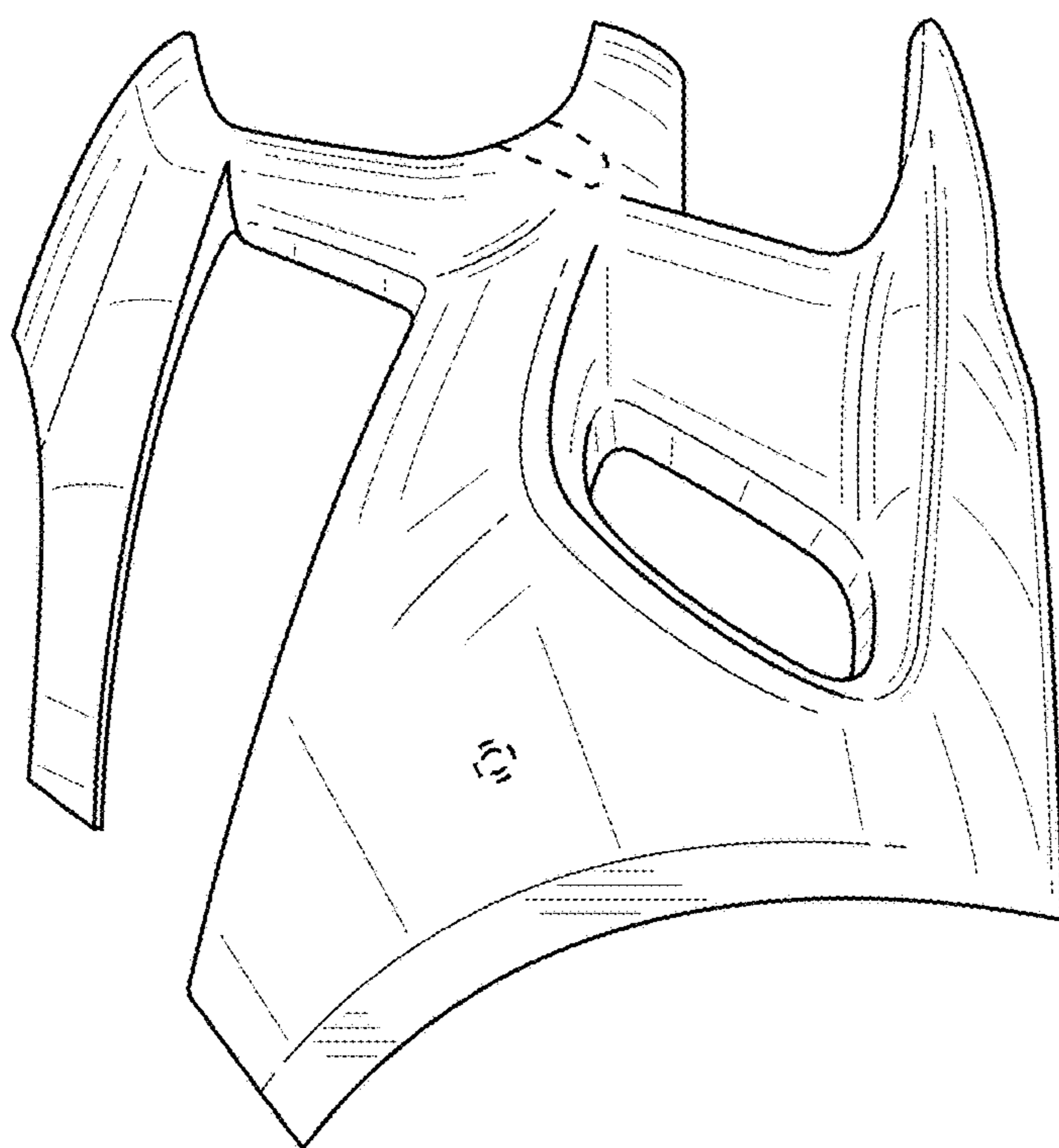
**FIG. 1**



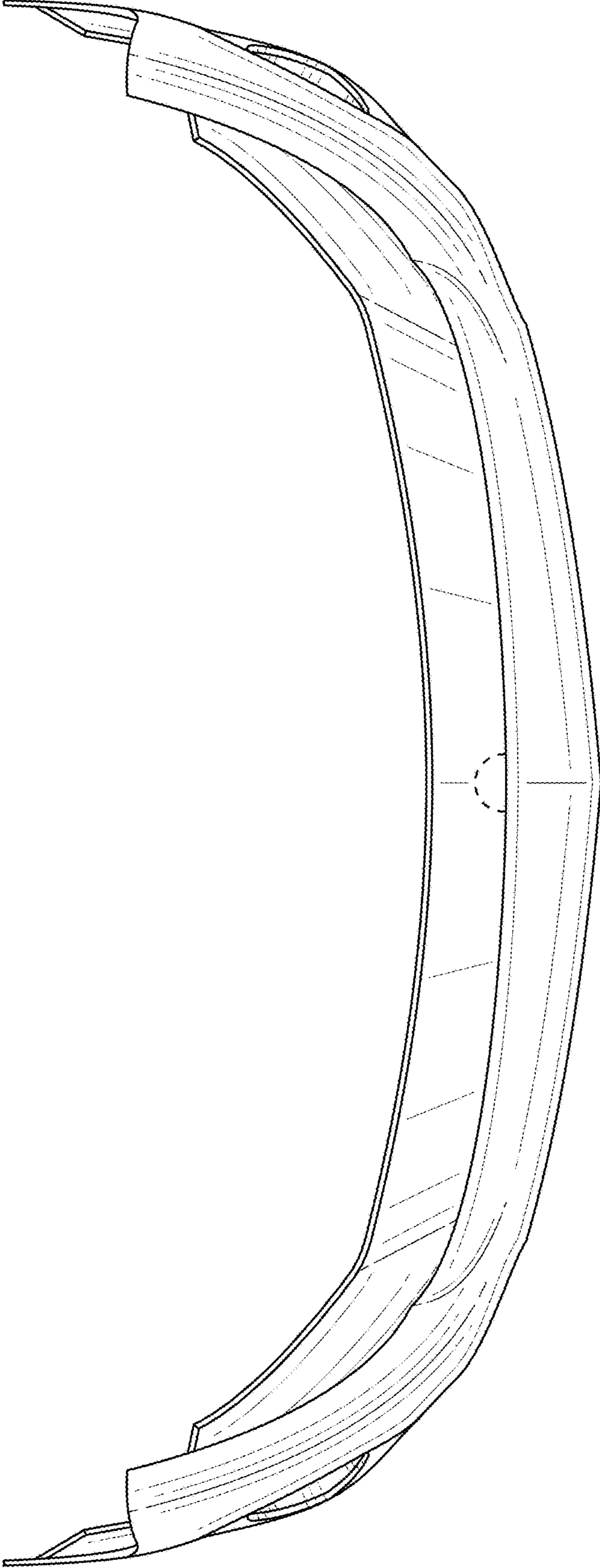
**FIG. 2**



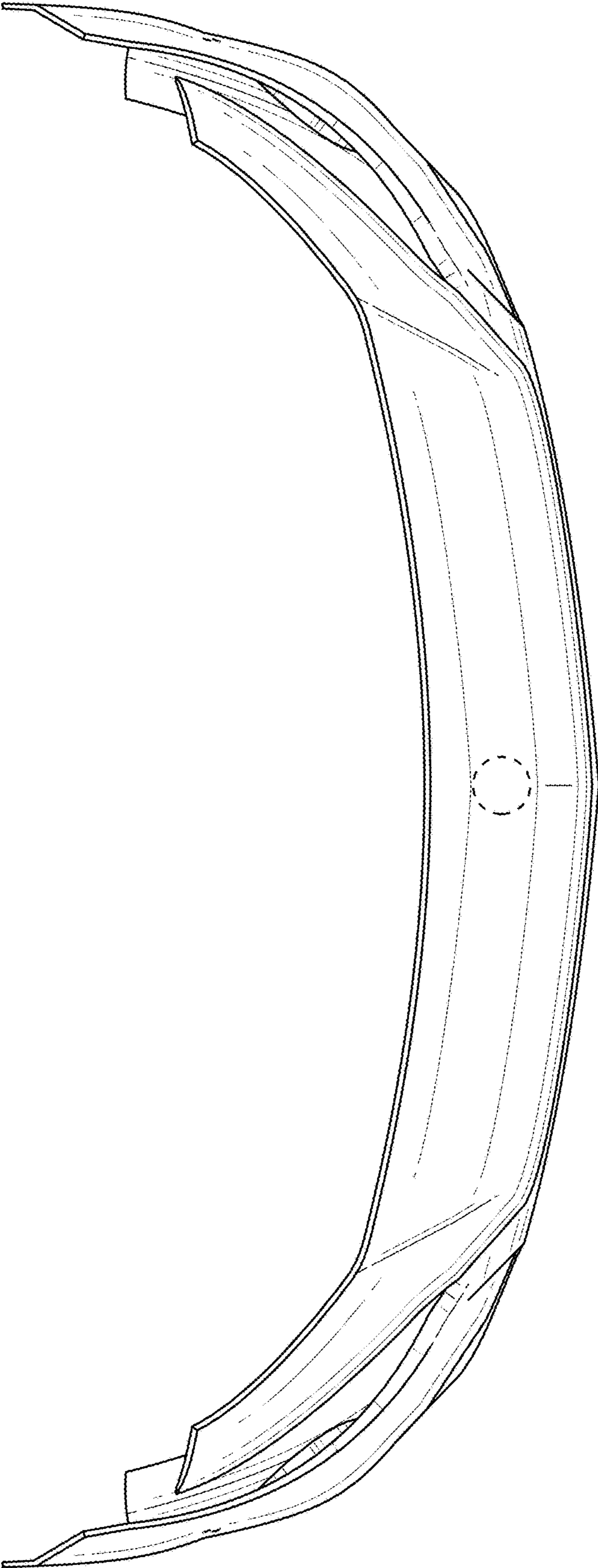
**FIG. 3**



**FIG. 4**



**FIG. 5**



**FIG. 6**