



US00D815959S

(12) **United States Design Patent** (10) **Patent No.:** **US D815,959 S**
Torchin et al. (45) **Date of Patent:** **** Apr. 24, 2018**

(54) **PACKAGE**

(71) Applicant: **Under Armour, Inc.**, Baltimore, MD (US)

(72) Inventors: **Evan Torchin**, Baltimore, MD (US);
Brian Boring, Baltimore, MD (US);
Helene Christman, Baltimore, MD (US); **Paul Pugh**, Baltimore, MD (US);
Eric Boam, Baltimore, MD (US);
Breyna Fries, Baltimore, MD (US)

(73) Assignee: **Under Armour, Inc.**, Baltimore, MD (US)

(**) Term: **15 Years**

(21) Appl. No.: **29/571,482**

(22) Filed: **Jul. 19, 2016**

(51) **LOC (11) Cl.** **09-01**

(52) **U.S. Cl.**
USPC **D9/737**

(58) **Field of Classification Search**
USPC D3/203.1–203.3, 203.7; D9/414–416,
D9/418, 420, 424–426, 428–430, 432,
(Continued)

(56) **References Cited**

U.S. PATENT DOCUMENTS

D22,290 S * 3/1893 Burnworth D19/77
968,286 A 8/1910 Streit
(Continued)

OTHER PUBLICATIONS

DC Rainmaker. Under Armour’s Healthbox: Wifi Scale, Fitness Band, HR Strap, and more! Published by Ray Maker. Jan. 5, 2016

[earliest online date], [site visited Jun. 7, 2017]. Available from Internet, URL: <https://www.dcrainmaker.com/2016/01/under-armour-healthbox.html>.*

Primary Examiner — Robert M. Spear

Assistant Examiner — Darcey E Heflin

(74) *Attorney, Agent, or Firm* — Maginot, Moore & Beck LLP

(57) **CLAIM**

The ornamental design for a package, as shown and described.

DESCRIPTION

Cross reference is made to copending U.S. design patent application Ser. No. 29/571,479 entitled “Package” by Torchin et al. filed on even date herewith; U.S. design patent application Ser. No. 29/571,480 entitled “Package” by Torchin et al. filed on even date herewith; U.S. design patent application Ser. No. 29/571,481 entitled “Package” by Torchin et al. filed on even date herewith; U.S. design patent application Ser. No. 29/571,483 entitled “Package” by Torchin et al. filed on even date herewith; and U.S. design patent application Ser. No. 29/571,484 entitled “Package” by Torchin et al. filed on even date herewith.

FIG. 1 is a perspective view of a package showing our new design;

FIG. 2 is a front elevational view showing the design for the package of FIG. 1;

FIG. 3 is a rear elevational view showing the design for the package of FIG. 1;

FIG. 4 is a left side elevational view showing the design for the package of FIG. 1;

FIG. 5 is a right side elevational view showing the design for the package of FIG. 1;

FIG. 6 is a top plan view showing the design for the package of FIG. 1; and,

FIG. 7 is a bottom plan view showing the design for the package of FIG. 1.

The broken lines shown in the drawings illustrate portions of the package that form no part of the claimed design.

1 Claim, 5 Drawing Sheets

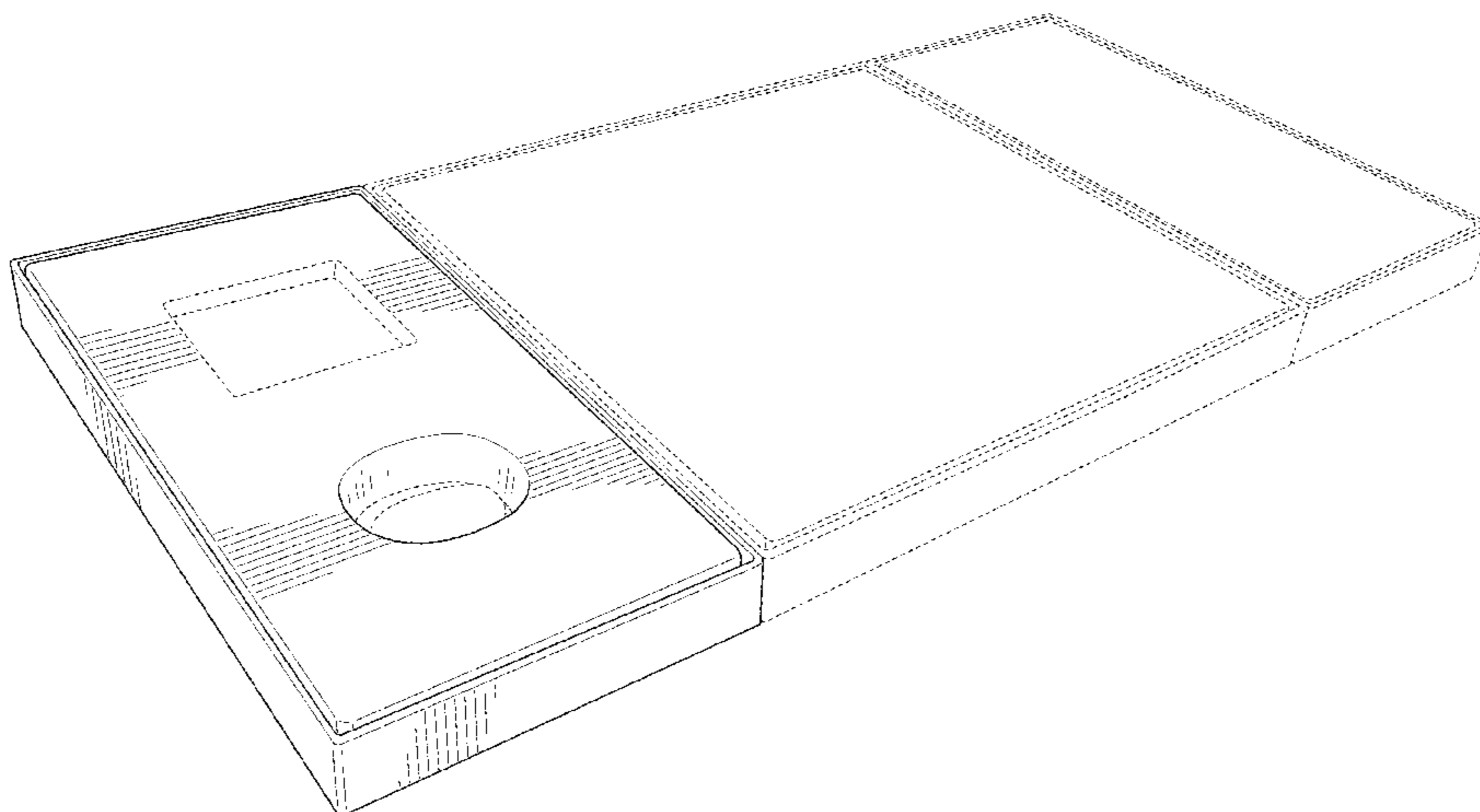

US D815,959 S

Page 2

(58) **Field of Classification Search**
USPC D9/434, 435, 455–457, 499, 707, 709,
D9/722, 737, 756, 759
CPC B65D 71/0003
See application file for complete search history.

(56) **References Cited**

U.S. PATENT DOCUMENTS

1,694,119 A 12/1928 Frank
D92,782 S 7/1934 Totjrtois
D94,457 S 1/1935 Williamson
2,007,089 A 7/1935 Jones
2,086,443 A 7/1937 Rutyna
2,329,866 A 9/1943 Sickels
D162,424 S 3/1951 Kulp
D190,253 S 5/1961 Chlop
3,755,925 A 9/1973 Court
D240,292 S 6/1976 Beaumont
D250,395 S 11/1978 Weil
4,287,986 A 9/1981 Beck
D262,461 S 12/1981 Holson
4,307,806 A 12/1981 Haubert
D264,602 S 5/1982 Plutsky
D265,989 S 8/1982 Harris
D280,290 S * 8/1985 Bakus D9/425
D285,503 S 9/1986 Weiner
4,609,104 A 9/1986 Kasper
D292,043 S 9/1987 Billiet
4,919,259 A 4/1990 Beaulieu
D309,109 S 7/1990 Allen
D309,564 S 7/1990 Rayner
RE33,503 E 12/1990 Schluger
D316,752 S 5/1991 Ricketts
D317,120 S 5/1991 Schwartzburg
D317,411 S 6/1991 Holmes
D322,760 S 12/1991 Blanchette
D326,279 S 5/1992 Logan
D332,048 S 12/1992 Pennell
5,167,205 A 12/1992 Bell
D339,287 S 9/1993 Levin
D347,386 S 5/1994 Conway
D348,836 S 7/1994 McCallum
D355,846 S 2/1995 Denney
D356,034 S 2/1995 Sugrue
D358,546 S * 5/1995 Walchek, Jr. D3/203.3
D358,767 S 5/1995 Berggren
D362,972 S 10/1995 Wunsch
D369,469 S * 5/1996 Gregory D3/313
D373,723 S 9/1996 Healey
D373,754 S 9/1996 Pinterpe
D375,680 S 11/1996 Liebermann
D385,781 S 11/1997 Levine
D393,591 S * 4/1998 Baryshyan D9/753
D398,527 S 9/1998 MacEachern
D399,135 S 10/1998 Mecca
D402,886 S * 12/1998 Stein D9/415
5,926,877 A 7/1999 Lin
D420,586 S 2/2000 MacEachern
D431,188 S 9/2000 Monn
D438,418 S 3/2001 Myszka
D443,388 S 6/2001 Roberts et al.
D447,687 S 9/2001 Roby
D452,628 S 1/2002 Stauffer
D458,128 S 6/2002 Gray
D469,296 S 1/2003 Byrne
D484,695 S 1/2004 Depalma
D511,093 S 11/2005 Keeton
6,991,100 B2 1/2006 Delaere
D514,315 S 2/2006 Lai
D515,941 S * 2/2006 Hamblin D24/230
D517,911 S 3/2006 Alexander
D518,676 S 4/2006 Ching Mau
D518,709 S 4/2006 Connolly
D519,367 S 4/2006 Alexander
7,040,899 B2 5/2006 Armstrong
D522,858 S * 6/2006 Snedden D9/435

D523,747 S 6/2006 Snedden
D530,913 S 10/2006 Chan
D541,146 S 4/2007 Cale
D547,056 S 7/2007 Griffin
D547,057 S 7/2007 Griffin
D552,300 S 10/2007 Dittmer
D570,682 S * 6/2008 Erden D9/430
D571,383 S 6/2008 Ota
D572,024 S 7/2008 Shapiro
D589,250 S 3/2009 Myers
7,511,950 B1 3/2009 Brekke
D591,534 S 5/2009 Fojtasek
D592,853 S 5/2009 Parker
D594,510 S 6/2009 Sappington
D596,935 S 7/2009 Golota
D600,964 S 9/2009 Elia
D601,798 S 10/2009 Hsu
7,607,699 B2 10/2009 Langford
D609,696 S 2/2010 Martinez
D610,350 S 2/2010 Smith
D613,123 S 4/2010 Hilger
D615,320 S 5/2010 Griffin
D620,352 S 7/2010 Liipola
D626,831 S 11/2010 Nicholas
D627,931 S 11/2010 Barresi
D631,353 S * 1/2011 Gelardi D9/455
D633,388 S * 3/2011 Andre D9/456
D642,935 S 8/2011 Bergeron
D644,514 S * 9/2011 Robins D9/456
D646,917 S 10/2011 Wynalda
8,033,393 B2 10/2011 Baker
D650,271 S 12/2011 Cluett
D653,854 S 2/2012 Chamberlain
D657,156 S 4/2012 Shih
D660,723 S * 5/2012 Akana D9/424
D663,201 S 7/2012 Carroll
D666,818 S 9/2012 Mbi
D667,302 S * 9/2012 Jones D9/456
D674,709 S * 1/2013 Akana D9/432
D682,680 S 5/2013 Terlesky
D683,950 S * 6/2013 Ernster D3/203.1
D685,654 S * 7/2013 Akana D9/432
D687,293 S 8/2013 Glass
D687,601 S 8/2013 Ko
D688,420 S 8/2013 Lai
D689,772 S * 9/2013 Jones D9/456
D690,591 S 10/2013 Sanders
D691,802 S 10/2013 Lin
D698,199 S 1/2014 Yessin
D701,757 S * 4/2014 Andre D9/432
D708,055 S 7/2014 Elston
D712,251 S 9/2014 Scott
D713,740 S * 9/2014 Akana D9/721
D714,136 S 9/2014 Stepanov
D716,648 S 11/2014 Hua Tan
D716,649 S 11/2014 McAdam
D717,164 S 11/2014 Rossiter
D718,123 S 11/2014 Street
D724,941 S 3/2015 Mattila
D724,942 S 3/2015 Mattila
D725,411 S 3/2015 Jannetides
D726,819 S 4/2015 Botha
D728,182 S 4/2015 Cook
D728,941 S 5/2015 Stoeckmann
D730,173 S 5/2015 Barad
D730,175 S 5/2015 Barad
D730,646 S 6/2015 Dechant
D730,742 S 6/2015 Glass
D733,557 S 7/2015 McAdam
D733,698 S 7/2015 Suzuki
D736,616 S * 8/2015 Suen D9/425
D737,688 S 9/2015 Stone
D738,721 S 9/2015 Song
D739,228 S 9/2015 Jondal
D742,741 S 11/2015 Rossiter
D748,392 S * 2/2016 Upchurch D3/203.2
D749,962 S 2/2016 Gorbatiuk
D751,498 S 3/2016 Munshi
D752,863 S 4/2016 Torggler

(56)

References Cited

U.S. PATENT DOCUMENTS

D754,598	S	4/2016	Munshi	
D755,118	S	5/2016	Munshi	
D755,119	S	5/2016	Munshi	
D758,851	S	6/2016	Binder	
D762,342	S	8/2016	Stenvik	
D762,487	S	8/2016	Safiullin	
D766,713	S	9/2016	Kiss	
D770,896	S *	11/2016	Johansson	D9/456
D772,559	S	11/2016	Binder	
D783,285	S *	4/2017	Hecht	D3/304
D783,547	S	4/2017	Bergmann	
D784,811	S	4/2017	Scevola	
D785,939	S	5/2017	Cooper	
D786,071	S	5/2017	Miller	
D786,073	S *	5/2017	Hutcheson, Jr.	D22/134
D790,334	S	6/2017	Pan	
2003/0102244	A1 *	6/2003	Sanders, Jr.	B65D 5/22 206/523
2005/0155259	A1	7/2005	Virvo	
2007/0251856	A1	11/2007	Zietlow	
2008/0041870	A1	2/2008	Smith	
2008/0245687	A1	10/2008	Gelardi	
2010/0126891	A1	5/2010	Schäfer	
2014/0163496	A1	6/2014	Grum-Schwensen	
2015/0102093	A1	4/2015	Melistas	
2015/0144512	A1	5/2015	D'Alfonso	
2016/0068296	A1	3/2016	Dammeyer	

* cited by examiner

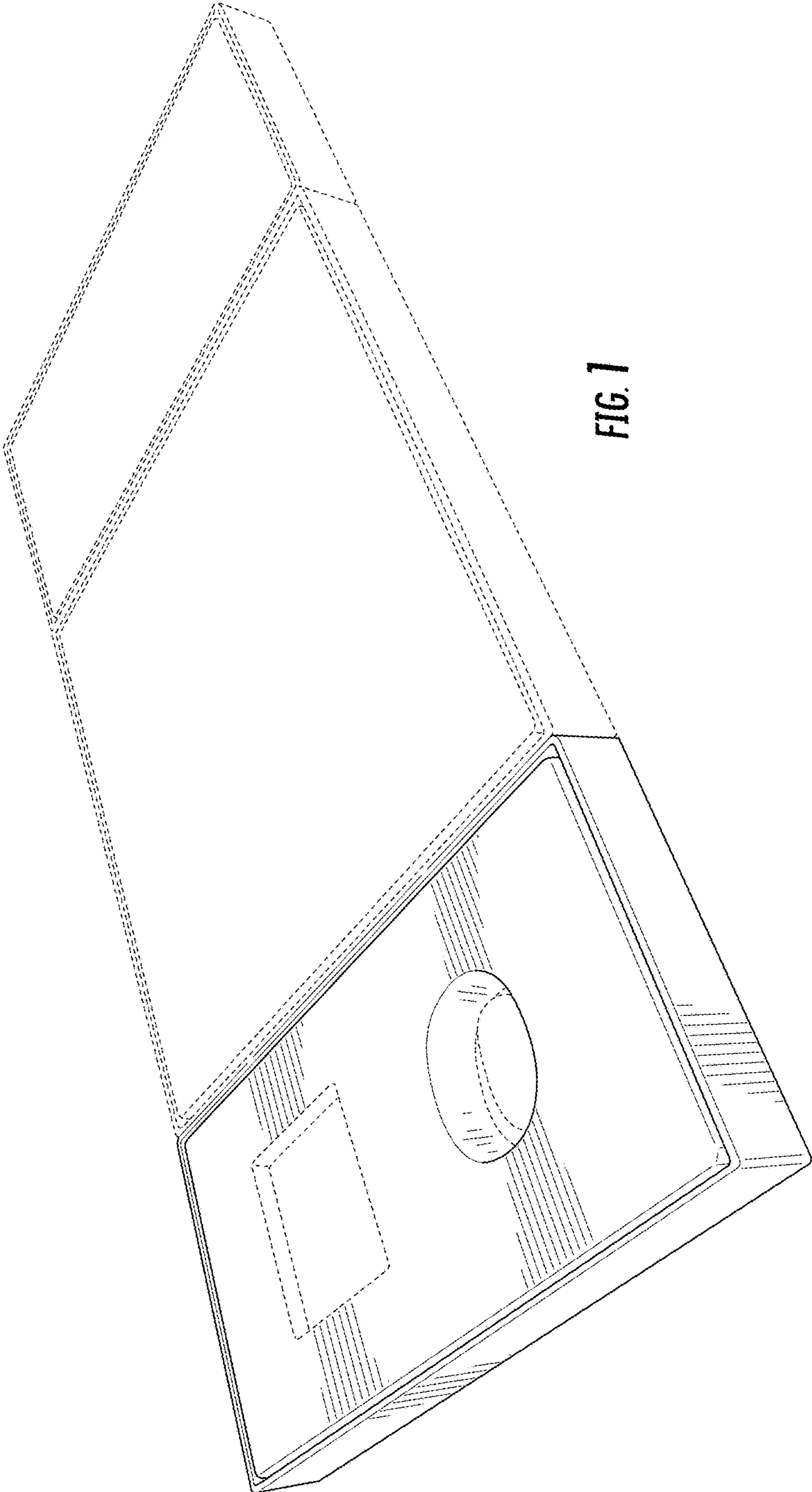

FIG. 1

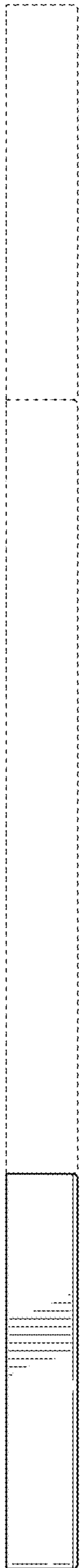

FIG. 2

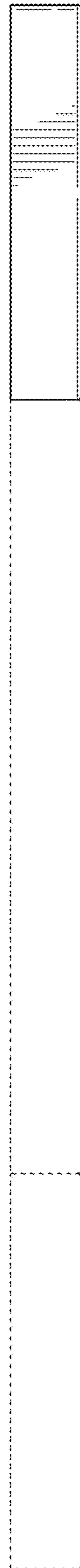

FIG. 3

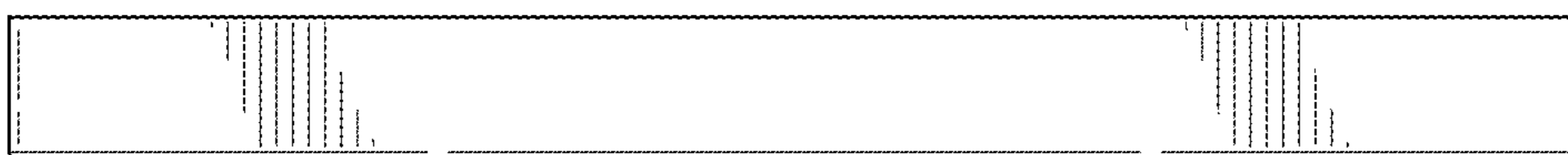

FIG. 4

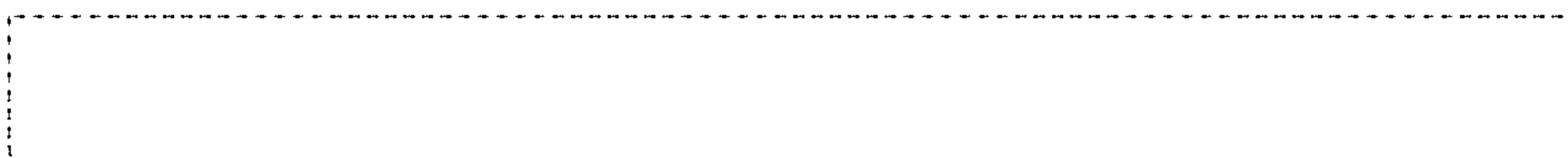

FIG. 5

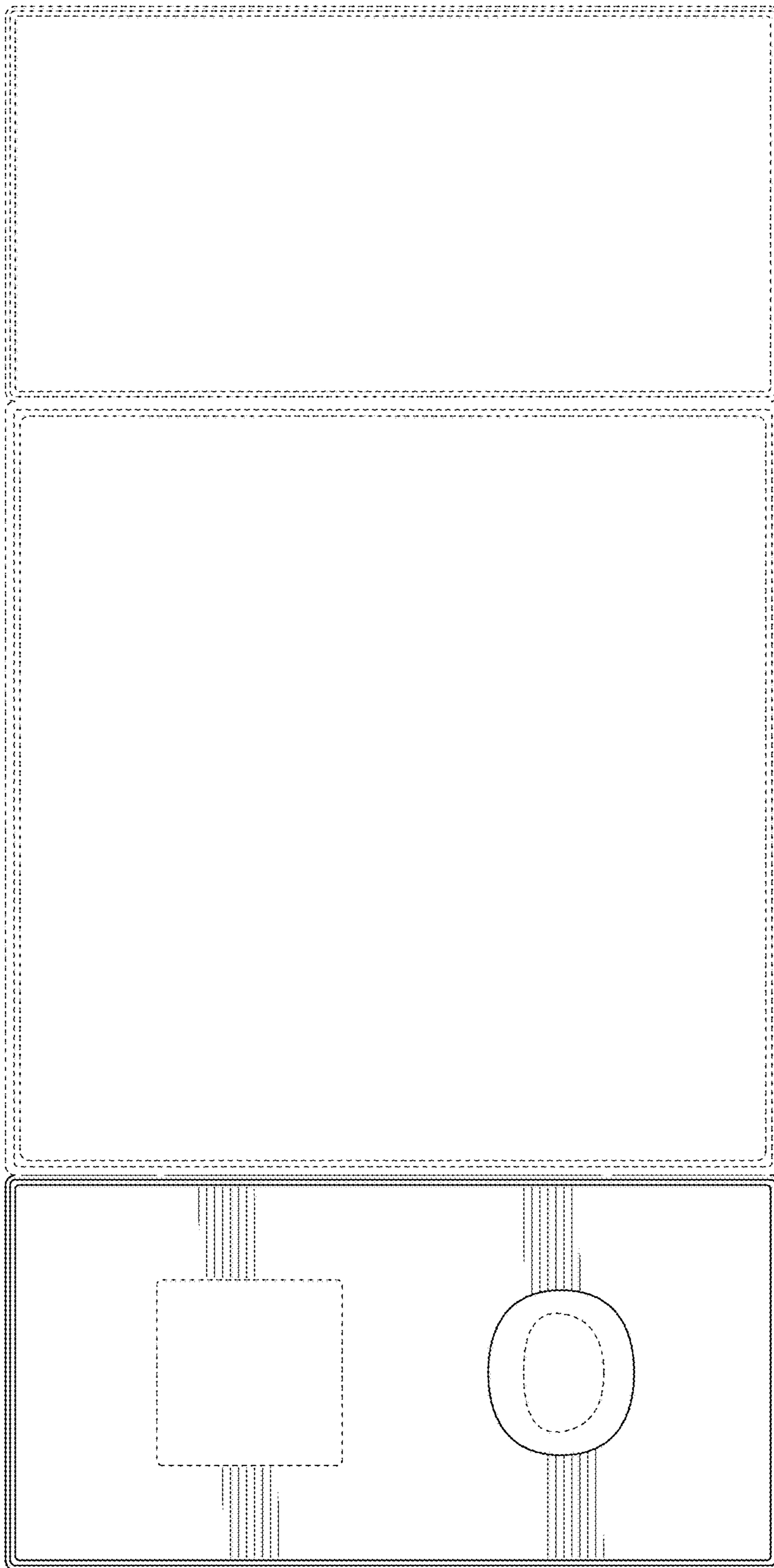

FIG. 6

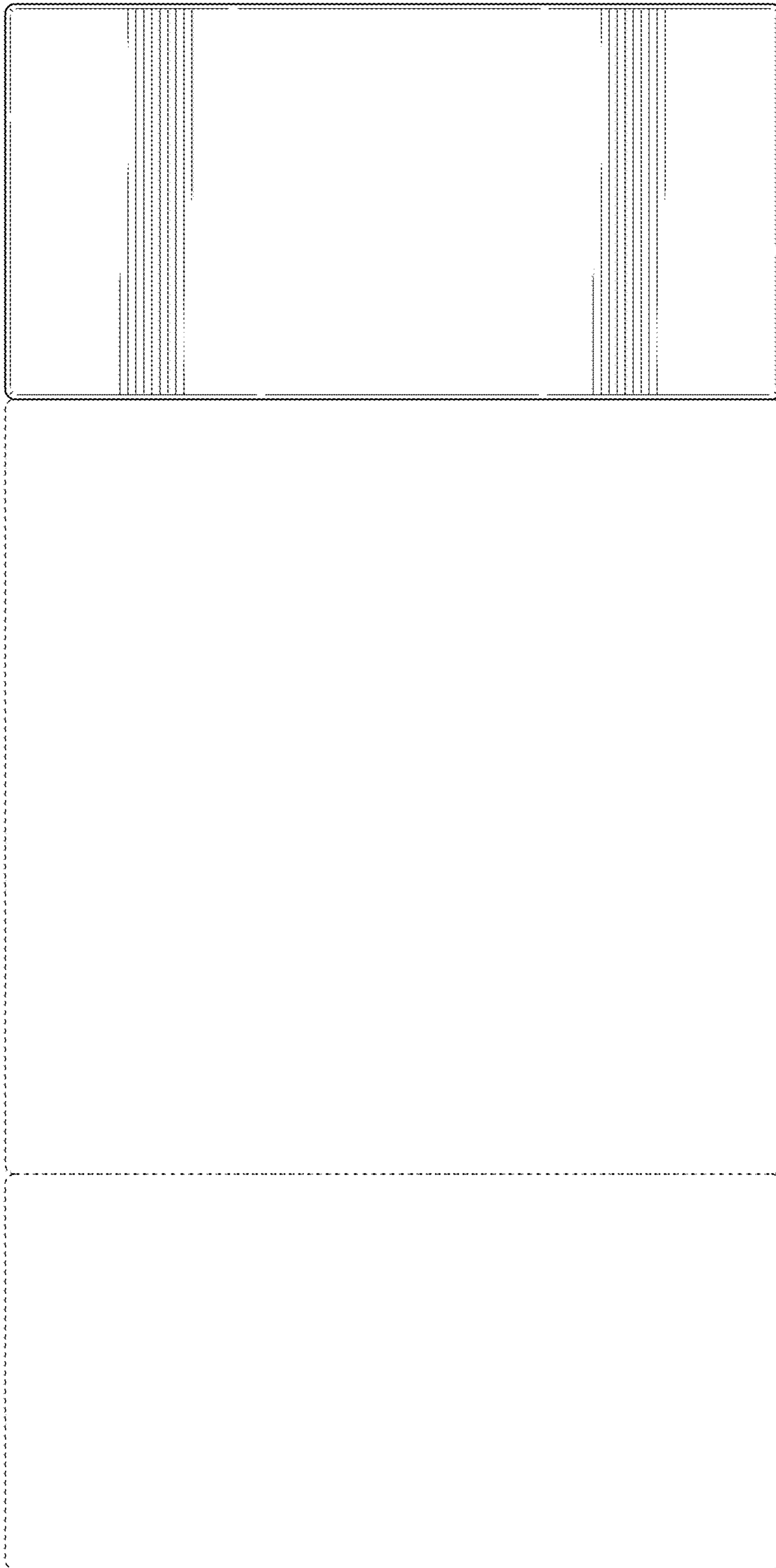

FIG. 7